

Sadri Hassani

Mathematical Physics

A Modern Introduction to
Its Foundations

Second Edition

 Springer

Mathematical Physics

Sadri Hassani

Mathematical Physics

A Modern Introduction to
Its Foundations

Second Edition

 Springer

Sadri Hassani
Department of Physics
Illinois State University
Normal, Illinois, USA

ISBN 978-3-319-01194-3

ISBN 978-3-319-01195-0 (eBook)

DOI 10.1007/978-3-319-01195-0

Springer Cham Heidelberg New York Dordrecht London

Library of Congress Control Number: 2013945405

© Springer International Publishing Switzerland 1999, 2013

This work is subject to copyright. All rights are reserved by the Publisher, whether the whole or part of the material is concerned, specifically the rights of translation, reprinting, reuse of illustrations, recitation, broadcasting, reproduction on microfilms or in any other physical way, and transmission or information storage and retrieval, electronic adaptation, computer software, or by similar or dissimilar methodology now known or hereafter developed. Exempted from this legal reservation are brief excerpts in connection with reviews or scholarly analysis or material supplied specifically for the purpose of being entered and executed on a computer system, for exclusive use by the purchaser of the work. Duplication of this publication or parts thereof is permitted only under the provisions of the Copyright Law of the Publisher's location, in its current version, and permission for use must always be obtained from Springer. Permissions for use may be obtained through RightsLink at the Copyright Clearance Center. Violations are liable to prosecution under the respective Copyright Law.

The use of general descriptive names, registered names, trademarks, service marks, etc. in this publication does not imply, even in the absence of a specific statement, that such names are exempt from the relevant protective laws and regulations and therefore free for general use.

While the advice and information in this book are believed to be true and accurate at the date of publication, neither the authors nor the editors nor the publisher can accept any legal responsibility for any errors or omissions that may be made. The publisher makes no warranty, express or implied, with respect to the material contained herein.

Printed on acid-free paper

Springer is part of Springer Science+Business Media (www.springer.com)

*To my wife, Sarah,
and to my children,
Dane Arash and Daisy Bitá*

Preface to Second Edition

Based on my own experience of teaching from the first edition, and more importantly based on the comments of the adopters and readers, I have made some significant changes to the new edition of the book: Part I is substantially rewritten, Part VIII has been changed to incorporate Clifford algebras, Part IX now includes the representation of Clifford algebras, and the new Part X discusses the important topic of fiber bundles.

I felt that a short section on *algebra* did not do justice to such an important topic. Therefore, I expanded it into a comprehensive chapter dealing with the basic properties of algebras and their classification. This required a rewriting of the chapter on operator algebras, including the introduction of a section on the representation of algebras in general. The chapter on *spectral decomposition* underwent a complete overhaul, as a result of which the topic is now more cohesive and the proofs more rigorous and illuminating. This entailed separate treatments of the spectral decomposition theorem for real and complex vector spaces.

The inner product of relativity is non-Euclidean. Therefore, in the discussion of tensors, I have explicitly expanded on the indefinite inner products and introduced a brief discussion of the subspaces of a non-Euclidean (the so-called semi-Riemannian or pseudo-Riemannian) vector space. This inner product, combined with the notion of algebra, leads naturally to *Clifford algebras*, the topic of the second chapter of Part VIII. Motivating the subject by introducing the Dirac equation, the chapter discusses the general properties of Clifford algebras in some detail and completely classifies the Clifford algebras $C_\mu^v(\mathbb{R})$, the generalization of the algebra $C_3^1(\mathbb{R})$, the Clifford algebra of the Minkowski space. The *representation* of Clifford algebras, including a treatment of *spinors*, is taken up in Part IX, after a discussion of the representation of Lie Groups and Lie algebras.

Fiber bundles have become a significant part of the lore of fundamental theoretical physics. The natural setting of gauge theories, essential in describing electroweak and strong interactions, is fiber bundles. Moreover, differential geometry, indispensable in the treatment of gravity, is most elegantly treated in terms of fiber bundles. Chapter 34 introduces fiber bundles and their complementary notion of *connection*, and the *curvature form* arising from the latter. Chapter 35 on *gauge theories* makes contact with physics and shows how connection is related to potentials and curvature to fields. It also constructs the most general gauge-invariant Lagrangian, including its local expression (the expression involving coordinate charts introduced on the underlying manifold), which is the form used by physicists. In Chap. 36,

by introducing vector bundles and linear connections, the stage becomes ready for the introduction of *curvature tensor* and *torsion*, two major players in differential geometry. This approach to differential geometry via fiber bundles is, in my opinion, the most elegant and intuitive approach, which avoids the ad hoc introduction of covariant derivative. Continuing with differential geometry, Chap. 37 incorporates the notion of inner product and metric into it, coming up with the *metric connection*, so essential in the general theory of relativity.

All these changes and additions required certain omissions. I was careful not to break the continuity and rigor of the book when omitting topics. Since none of the discussions of numerical analysis was used anywhere else in the book, these were the first casualties. A few mathematical treatments that were too dry, technical, and not inspiring were also removed from the new edition. However, I provided references in which the reader can find these missing details. The only casualty of this kind of omission was the discussion leading to the spectral decomposition theorem for compact operators in Chap. 17.

Aside from the above changes, I have also altered the style of the book considerably. Now all mathematical statements—*theorems, propositions, corollaries, definitions, remarks, etc.*—and examples are numbered consecutively without regard to their types. This makes finding those statements or examples considerably easier. I have also placed important mathematical statements in boxes which are more visible as they have dark backgrounds. Additionally, I have increased the number of marginal notes, and added many more entries to the index.

Many readers and adopters provided invaluable feedback, both in spotting typos and in clarifying vague and even erroneous statements of the book. I would like to acknowledge the contribution of the following people to the correction of errors and the clarification of concepts: Sylvio Andrade, Salar Baher, Rafael Benguria, Jim Bogan, Jorun Bomert, John Chaffer, Demetris Charalambous, Robert Gooding, Paul Haines, Carl Helrich, Ray Jensen, Jin-Wook Jung, David Kastor, Fred Keil, Mike Lieber, Art Lind, Gary Miller, John Morgan, Thomas Schaefer, Hossein Shojaie, Shreenivas Somayaji, Werner Timmermann, Johan Wild, Bradley Wogsland, and Fang Wu. As much as I tried to keep a record of individuals who gave me feedback on the first edition, fourteen years is a long time, and I may have omitted some names from the list above. To those people, I sincerely apologize. Needless to say, any remaining errors in this new edition is solely my responsibility, and as always, I'll greatly appreciate it if the readers continue pointing them out to me.

I consulted the following three excellent books to a great extent for the addition and/or changes in the second edition:

Greub, W., *Linear Algebra*, 4th ed., Springer-Verlag, Berlin, 1975.

Greub, W., *Multilinear Algebra*, 2nd ed., Springer-Verlag, Berlin, 1978.

Kobayashi, S., and K. Nomizu, *Foundations of Differential Geometry*, vol. 1, Wiley, New York, 1963.

Maury Solomon, my editor at Springer, was immeasurably patient and cooperative on a project that has been long overdue. Aldo Rampioni has

been extremely helpful and cooperative as he took over the editorship of the project. My sincere thanks go to both of them. Finally, I would like to thank my wife Sarah for her unwavering forbearance and encouragement throughout the long-drawn-out writing of the new edition.

Normal, IL, USA
November, 2012

Sadri Hassani

Preface to First Edition

“Ich kann es nun einmal nicht lassen, in diesem Drama von Mathematik und Physik—die sich im Dunkeln befruchten, aber von Angesicht zu Angesicht so gerne einander verkennen und verleugnen—die Rolle des (wie ich genügsam erfuhr, oft unerwünschten) *Boten* zu spielen.”

Hermann Weyl

It is said that mathematics is the language of Nature. If so, then physics is its poetry. Nature started to whisper into our ears when Egyptians and Babylonians were compelled to invent and use mathematics in their day-to-day activities. The faint geometric and arithmetical pidgin of over four thousand years ago, suitable for rudimentary conversations with nature as applied to simple landscaping, has turned into a sophisticated language in which the heart of matter is articulated.

The interplay between mathematics and physics needs no emphasis. What may need to be emphasized is that mathematics is not merely a tool with which the presentation of physics is facilitated, but the only medium in which physics can survive. Just as language is the means by which humans can express their thoughts and without which they lose their unique identity, mathematics is the only language through which physics can express itself and without which it loses its identity. And just as language is perfected due to its constant usage, mathematics develops in the most dramatic way because of its usage in physics. The quotation by Weyl above, an approximation to whose translation is “*In this drama of mathematics and physics—which fertilize each other in the dark, but which prefer to deny and misconstrue each other face to face—I cannot, however, resist playing the role of a messenger, albeit, as I have abundantly learned, often an unwelcome one,*” is a perfect description of the natural intimacy between what mathematicians and physicists do, and the unnatural estrangement between the two camps. Some of the most beautiful mathematics has been motivated by physics (differential equations by Newtonian mechanics, differential geometry by general relativity, and operator theory by quantum mechanics), and some of the most fundamental physics has been expressed in the most beautiful poetry of mathematics (mechanics in symplectic geometry, and fundamental forces in Lie group theory).

I do not want to give the impression that mathematics and physics cannot develop independently. On the contrary, it is precisely the independence of each discipline that reinforces not only itself, but the other discipline as well—just as the study of the grammar of a language improves its usage and vice versa. However, the most effective means by which the two camps can

accomplish great success is through an intense dialogue. Fortunately, with the advent of gauge and string theories of particle physics, such a dialogue has been reestablished between physics and mathematics after a relatively long lull.

Level and Philosophy of Presentation

This is a book for physics students interested in the mathematics they use. It is also a book for mathematics students who wish to see some of the abstract ideas with which they are familiar come alive in an applied setting. The level of presentation is that of an advanced undergraduate or beginning graduate course (or sequence of courses) traditionally called “Mathematical Methods of Physics” or some variation thereof. Unlike most existing mathematical physics books intended for the same audience, which are usually lexicographic collections of facts about the diagonalization of matrices, tensor analysis, Legendre polynomials, contour integration, etc., with little emphasis on formal and systematic development of topics, this book attempts to strike a balance between formalism and application, between the abstract and the concrete.

I have tried to include as much of the essential formalism as is necessary to render the book optimally coherent and self-contained. This entails stating and proving a large number of theorems, propositions, lemmas, and corollaries. The benefit of such an approach is that the student will recognize clearly both the power and the limitation of a mathematical idea used in physics. There is a tendency on the part of the novice to universalize the mathematical methods and ideas encountered in physics courses because the limitations of these methods and ideas are not clearly pointed out.

There is a great deal of freedom in the topics and the level of presentation that instructors can choose from this book. My experience has shown that Parts I, II, III, Chap. 12, selected sections of Chap. 13, and selected sections or examples of Chap. 19 (or a large subset of all this) will be a reasonable course content for advanced undergraduates. If one adds Chaps. 14 and 20, as well as selected topics from Chaps. 21 and 22, one can design a course suitable for first-year graduate students. By judicious choice of topics from Parts VII and VIII, the instructor can bring the content of the course to a more modern setting. Depending on the sophistication of the students, this can be done either in the first year or the second year of graduate school.

Features

To better understand theorems, propositions, and so forth, students need to see them in action. There are over 350 worked-out examples and over 850 problems (many with detailed hints) in this book, providing a vast arena in which students can watch the formalism unfold. The philosophy underlying this abundance can be summarized as “An example is worth a thousand words of explanation.” Thus, whenever a statement is intrinsically vague or

hard to grasp, worked-out examples and/or problems with hints are provided to clarify it. The inclusion of such a large number of examples is the means by which the balance between formalism and application has been achieved. However, although applications are essential in understanding mathematical physics, they are only one side of the coin. The theorems, propositions, lemmas, and corollaries, being highly condensed versions of knowledge, are equally important.

A conspicuous feature of the book, which is not emphasized in other comparable books, is the attempt to exhibit—as much as it is useful and applicable—interrelationships among various topics covered. Thus, the underlying theme of a vector space (which, in my opinion, is the most primitive concept at this level of presentation) recurs throughout the book and alerts the reader to the connection between various seemingly unrelated topics.

Another useful feature is the presentation of the historical setting in which men and women of mathematics and physics worked. I have gone against the trend of the “ahistoricism” of mathematicians and physicists by summarizing the life stories of the people behind the ideas. Many a time, the anecdotes and the historical circumstances in which a mathematical or physical idea takes form can go a long way toward helping us understand and appreciate the idea, especially if the interaction among—and the contributions of—all those having a share in the creation of the idea is pointed out, and the historical continuity of the development of the idea is emphasized.

To facilitate reference to them, all mathematical statements (definitions, theorems, propositions, lemmas, corollaries, and examples) have been numbered consecutively within each section and are preceded by the section number. For example, 4.2.9 *Definition* indicates the ninth mathematical statement (which happens to be a definition) in Sect. 4.2. The end of a proof is marked by an empty square \square , and that of an example by a filled square \blacksquare , placed at the right margin of each.

Finally, a comprehensive index, a large number of marginal notes, and many explanatory underbraced and overbraced comments in equations facilitate the use and comprehension of the book. In this respect, the book is also useful as a reference.

Organization and Topical Coverage

Aside from Chap. 0, which is a collection of purely mathematical concepts, the book is divided into eight parts. Part I, consisting of the first four chapters, is devoted to a thorough study of finite-dimensional vector spaces and linear operators defined on them. As the unifying theme of the book, vector spaces demand careful analysis, and Part I provides this in the more accessible setting of finite dimension in a language that is conveniently generalized to the more relevant infinite dimensions, the subject of the next part.

Following a brief discussion of the technical difficulties associated with infinity, Part II is devoted to the two main infinite-dimensional vector spaces of mathematical physics: the classical orthogonal polynomials, and Fourier series and transform.

Complex variables appear in Part III. Chapter 9 deals with basic properties of complex functions, complex series, and their convergence. Chapter 10 discusses the calculus of residues and its application to the evaluation of definite integrals. Chapter 11 deals with more advanced topics such as multi-valued functions, analytic continuation, and the method of steepest descent.

Part IV treats mainly ordinary differential equations. Chapter 12 shows how ordinary differential equations of second order arise in physical problems, and Chap. 13 consists of a formal discussion of these differential equations as well as methods of solving them numerically. Chapter 14 brings in the power of complex analysis to a treatment of the hypergeometric differential equation. The last chapter of this part deals with the solution of differential equations using integral transforms.

Part V starts with a formal chapter on the theory of operator and their spectral decomposition in Chap. 16. Chapter 17 focuses on a specific type of operator, namely the integral operators and their corresponding integral equations. The formalism and applications of Sturm-Liouville theory appear in Chaps. 18 and 19, respectively.

The entire Part VI is devoted to a discussion of Green's functions. Chapter 20 introduces these functions for ordinary differential equations, while Chaps. 21 and 22 discuss the Green's functions in an m -dimensional Euclidean space. Some of the derivations in these last two chapters are new and, as far as I know, unavailable anywhere else.

Parts VII and VIII contain a thorough discussion of Lie groups and their applications. The concept of group is introduced in Chap. 23. The theory of group representation, with an eye on its application in quantum mechanics, is discussed in the next chapter. Chapters 25 and 26 concentrate on tensor algebra and tensor analysis on manifolds. In Part VIII, the concepts of group and manifold are brought together in the context of Lie groups. Chapter 27 discusses Lie groups and their algebras as well as their representations, with special emphasis on their application in physics. Chapter 28 is on differential geometry including a brief introduction to general relativity. Lie's original motivation for constructing the groups that bear his name is discussed in Chap. 29 in the context of a systematic treatment of differential equations using their symmetry groups. The book ends in a chapter that blends many of the ideas developed throughout the previous parts in order to treat variational problems and their symmetries. It also provides a most fitting example of the claim made at the beginning of this preface and one of the most beautiful results of mathematical physics: Noether's theorem on the relation between symmetries and conservation laws.

Acknowledgments

It gives me great pleasure to thank all those who contributed to the making of this book. George Rutherford was kind enough to volunteer for the difficult task of condensing hundreds of pages of biography into tens of extremely informative pages. Without his help this unique and valuable feature of the book would have been next to impossible to achieve. I thank him wholeheartedly. Rainer Grobe and Qichang Su helped me with my rusty

computational skills. (R.G. also helped me with my rusty German!) Many colleagues outside my department gave valuable comments and stimulating words of encouragement on the earlier version of the book. I would like to record my appreciation to Neil Rasband for reading part of the manuscript and commenting on it. Special thanks go to Tom von Foerster, senior editor of physics and mathematics at Springer-Verlag, not only for his patience and support, but also for the extreme care he took in reading the entire manuscript and giving me invaluable advice as a result. Needless to say, the ultimate responsibility for the content of the book rests on me. Last but not least, I thank my wife, Sarah, my son, Dane, and my daughter, Daisy, for the time taken away from them while I was writing the book, and for their support during the long and arduous writing process.

Many excellent textbooks, too numerous to cite individually here, have influenced the writing of this book. The following, however, are noteworthy for both their excellence and the amount of their influence:

Birkhoff, G., and G.-C. Rota, *Ordinary Differential Equations*, 3rd ed., New York, Wiley, 1978.

Bishop, R., and S. Goldberg, *Tensor Analysis on Manifolds*, New York, Dover, 1980.

Dennery, P., and A. Krzywicki, *Mathematics for Physicists*, New York, Harper & Row, 1967.

Halmos, P., *Finite-Dimensional Vector Spaces*, 2nd ed., Princeton, Van Nostrand, 1958.

Hamermesh, M., *Group Theory and its Application to Physical Problems*, Dover, New York, 1989.

Olver, P., *Application of Lie Groups to Differential Equations*, New York, Springer-Verlag, 1986.

Unless otherwise indicated, all biographical sketches have been taken from the following three sources:

Gillispie, C., ed., *Dictionary of Scientific Biography*, Charles Scribner's, New York, 1970.

Simmons, G., *Calculus Gems*, New York, McGraw-Hill, 1992.

History of Mathematics archive at www-groups.dcs.st-and.ac.uk:80.

I would greatly appreciate any comments and suggestions for improvements. Although extreme care was taken to correct all the misprints, the mere volume of the book makes it very likely that I have missed some (perhaps many) of them. I shall be most grateful to those readers kind enough to bring to my attention any remaining mistakes, typographical or otherwise. Please feel free to contact me.

Sadri Hassani
Campus Box 4560
Department of Physics
Illinois State University
Normal, IL 61790-4560, USA
e-mail: hassani@entropy.phy.ilstu.edu

It is my pleasure to thank all those readers who pointed out typographical mistakes and suggested a few clarifying changes. With the exception of a couple that required substantial revision, I have incorporated all the corrections and suggestions in this second printing.

Note to the Reader

Mathematics and physics are like the game of chess (or, for that matter, like any game)—you will learn only by “playing” them. No amount of reading about the game will make you a master. In this book you will find a large number of examples and problems. Go through as many examples as possible, and try to reproduce them. Pay particular attention to sentences like “The reader may check . . .” or “It is straightforward to show . . .”. These are red flags warning you that for a good understanding of the material at hand, you need to provide the missing steps. The problems often fill in missing steps as well; and in this respect they are essential for a thorough understanding of the book. Do not get discouraged if you cannot get to the solution of a problem at your first attempt. If you start from the beginning and think about each problem hard enough, you *will* get to the solution, and you will see that the subsequent problems will not be as difficult.

The extensive index makes the specific topics about which you may be interested to learn easily accessible. Often the marginal notes will help you easily locate the index entry you are after.

I have included a large collection of biographical sketches of mathematical physicists of the past. These are truly inspiring stories, and I encourage you to read them. They let you see that even under excruciating circumstances, the human mind can work miracles. You will discover how these remarkable individuals overcame the political, social, and economic conditions of their time to let us get a faint glimpse of the truth. They are our true heroes.

Contents

| | | |
|--|-----------------------------------|-----------|
| 1 | Mathematical Preliminaries | 1 |
| 1.1 | Sets | 1 |
| 1.1.1 | Equivalence Relations | 3 |
| 1.2 | Maps | 4 |
| 1.3 | Metric Spaces | 8 |
| 1.4 | Cardinality | 10 |
| 1.5 | Mathematical Induction | 12 |
| 1.6 | Problems | 14 |
| Part I Finite-Dimensional Vector Spaces | | |
| 2 | Vectors and Linear Maps | 19 |
| 2.1 | Vector Spaces | 19 |
| 2.1.1 | Subspaces | 22 |
| 2.1.2 | Factor Space | 24 |
| 2.1.3 | Direct Sums | 25 |
| 2.1.4 | Tensor Product of Vector Spaces | 28 |
| 2.2 | Inner Product | 29 |
| 2.2.1 | Orthogonality | 32 |
| 2.2.2 | The Gram-Schmidt Process | 33 |
| 2.2.3 | The Schwarz Inequality | 35 |
| 2.2.4 | Length of a Vector | 36 |
| 2.3 | Linear Maps | 38 |
| 2.3.1 | Kernel of a Linear Map | 41 |
| 2.3.2 | Linear Isomorphism | 43 |
| 2.4 | Complex Structures | 45 |
| 2.5 | Linear Functionals | 48 |
| 2.6 | Multilinear Maps | 53 |
| 2.6.1 | Determinant of a Linear Operator | 55 |
| 2.6.2 | Classical Adjoint | 56 |
| 2.7 | Problems | 57 |
| 3 | Algebras | 63 |
| 3.1 | From Vector Space to Algebra | 63 |
| 3.1.1 | General Properties | 64 |
| 3.1.2 | Homomorphisms | 70 |
| 3.2 | Ideals | 73 |
| 3.2.1 | Factor Algebras | 77 |

| | | |
|----------|--|------------|
| 3.3 | Total Matrix Algebra | 78 |
| 3.4 | Derivation of an Algebra | 80 |
| 3.5 | Decomposition of Algebras | 83 |
| 3.5.1 | The Radical | 84 |
| 3.5.2 | Semi-simple Algebras | 88 |
| 3.5.3 | Classification of Simple Algebras | 92 |
| 3.6 | Polynomial Algebra | 95 |
| 3.7 | Problems | 97 |
| 4 | Operator Algebra | 101 |
| 4.1 | Algebra of $\text{End}(V)$ | 101 |
| 4.1.1 | Polynomials of Operators | 102 |
| 4.1.2 | Functions of Operators | 104 |
| 4.1.3 | Commutators | 106 |
| 4.2 | Derivatives of Operators | 107 |
| 4.3 | Conjugation of Operators | 113 |
| 4.3.1 | Hermitian Operators | 114 |
| 4.3.2 | Unitary Operators | 118 |
| 4.4 | Idempotents | 119 |
| 4.4.1 | Projection Operators | 120 |
| 4.5 | Representation of Algebras | 125 |
| 4.6 | Problems | 131 |
| 5 | Matrices | 137 |
| 5.1 | Representing Vectors and Operators | 137 |
| 5.2 | Operations on Matrices | 142 |
| 5.3 | Orthonormal Bases | 146 |
| 5.4 | Change of Basis | 148 |
| 5.5 | Determinant of a Matrix | 151 |
| 5.5.1 | Matrix of the Classical Adjoint | 152 |
| 5.5.2 | Inverse of a Matrix | 155 |
| 5.5.3 | Dual Determinant Function | 158 |
| 5.6 | The Trace | 160 |
| 5.7 | Problems | 163 |
| 6 | Spectral Decomposition | 169 |
| 6.1 | Invariant Subspaces | 169 |
| 6.2 | Eigenvalues and Eigenvectors | 172 |
| 6.3 | Upper-Triangular Representations | 175 |
| 6.4 | Complex Spectral Decomposition | 177 |
| 6.4.1 | Simultaneous Diagonalization | 185 |
| 6.5 | Functions of Operators | 188 |
| 6.6 | Real Spectral Decomposition | 191 |
| 6.6.1 | The Case of Symmetric Operators | 193 |
| 6.6.2 | The Case of Real Normal Operators | 198 |
| 6.7 | Polar Decomposition | 205 |
| 6.8 | Problems | 208 |

Part II Infinite-Dimensional Vector Spaces

7 Hilbert Spaces 215

7.1 The Question of Convergence 215

7.2 The Space of Square-Integrable Functions 221

7.2.1 Orthogonal Polynomials 222

7.2.2 Orthogonal Polynomials and Least Squares 225

7.3 Continuous Index 227

7.4 Generalized Functions 233

7.5 Problems 237

8 Classical Orthogonal Polynomials 241

8.1 General Properties 241

8.2 Classification 244

8.3 Recurrence Relations 245

8.4 Details of Specific Examples 248

8.4.1 Hermite Polynomials 248

8.4.2 Laguerre Polynomials 249

8.4.3 Legendre Polynomials 250

8.4.4 Other Classical Orthogonal Polynomials 252

8.5 Expansion in Terms of Orthogonal Polynomials 254

8.6 Generating Functions 257

8.7 Problems 258

9 Fourier Analysis 265

9.1 Fourier Series 265

9.1.1 The Gibbs Phenomenon 273

9.1.2 Fourier Series in Higher Dimensions 275

9.2 Fourier Transform 276

9.2.1 Fourier Transforms and Derivatives 284

9.2.2 The Discrete Fourier Transform 286

9.2.3 Fourier Transform of a Distribution 287

9.3 Problems 288

Part III Complex Analysis

10 Complex Calculus 295

10.1 Complex Functions 295

10.2 Analytic Functions 297

10.3 Conformal Maps 304

10.4 Integration of Complex Functions 309

10.5 Derivatives as Integrals 315

10.6 Infinite Complex Series 319

10.6.1 Properties of Series 319

10.6.2 Taylor and Laurent Series 321

10.7 Problems 330

11 Calculus of Residues 339

11.1 Residues 339

11.2 Classification of Isolated Singularities 342

11.3 Evaluation of Definite Integrals 344

| | | |
|---------------------------------------|---|------------|
| 11.3.1 | Integrals of Rational Functions | 345 |
| 11.3.2 | Products of Rational and Trigonometric Functions | 348 |
| 11.3.3 | Functions of Trigonometric Functions | 350 |
| 11.3.4 | Some Other Integrals | 352 |
| 11.3.5 | Principal Value of an Integral | 354 |
| 11.4 | Problems | 359 |
| 12 | Advanced Topics | 363 |
| 12.1 | Meromorphic Functions | 363 |
| 12.2 | Multivalued Functions | 365 |
| 12.2.1 | Riemann Surfaces | 366 |
| 12.3 | Analytic Continuation | 372 |
| 12.3.1 | The Schwarz Reflection Principle | 374 |
| 12.3.2 | Dispersion Relations | 376 |
| 12.4 | The Gamma and Beta Functions | 378 |
| 12.5 | Method of Steepest Descent | 382 |
| 12.6 | Problems | 388 |
| Part IV Differential Equations | | |
| 13 | Separation of Variables in Spherical Coordinates | 395 |
| 13.1 | PDEs of Mathematical Physics | 395 |
| 13.2 | Separation of the Angular Part | 398 |
| 13.3 | Construction of Eigenvalues of \mathbf{L}^2 | 401 |
| 13.4 | Eigenvectors of \mathbf{L}^2 : Spherical Harmonics | 406 |
| 13.4.1 | Expansion of Angular Functions | 411 |
| 13.4.2 | Addition Theorem for Spherical Harmonics | 412 |
| 13.5 | Problems | 413 |
| 14 | Second-Order Linear Differential Equations | 417 |
| 14.1 | General Properties of ODEs | 417 |
| 14.2 | Existence/Uniqueness for First-Order DEs | 419 |
| 14.3 | General Properties of SOLDEs | 421 |
| 14.4 | The Wronskian | 425 |
| 14.4.1 | A Second Solution to the HSOLDE | 426 |
| 14.4.2 | The General Solution to an ISOLDE | 428 |
| 14.4.3 | Separation and Comparison Theorems | 430 |
| 14.5 | Adjoint Differential Operators | 433 |
| 14.6 | Power-Series Solutions of SOLDEs | 436 |
| 14.6.1 | Frobenius Method of Undetermined Coefficients | 439 |
| 14.6.2 | Quantum Harmonic Oscillator | 444 |
| 14.7 | SOLDEs with Constant Coefficients | 446 |
| 14.8 | The WKB Method | 450 |
| 14.8.1 | Classical Limit of the Schrödinger Equation | 452 |
| 14.9 | Problems | 453 |
| 15 | Complex Analysis of SOLDEs | 459 |
| 15.1 | Analytic Properties of Complex DEs | 460 |
| 15.1.1 | Complex FOLDEs | 460 |
| 15.1.2 | The Circuit Matrix | 462 |

| | | |
|---|---|------------|
| 15.2 | Complex SOLDEs | 463 |
| 15.3 | Fuchsian Differential Equations | 469 |
| 15.4 | The Hypergeometric Function | 473 |
| 15.5 | Confluent Hypergeometric Functions | 478 |
| 15.5.1 | Hydrogen-Like Atoms | 480 |
| 15.5.2 | Bessel Functions | 482 |
| 15.6 | Problems | 485 |
| 16 | Integral Transforms and Differential Equations | 493 |
| 16.1 | Integral Representation of the Hypergeometric Function | 494 |
| 16.1.1 | Integral Representation of the Confluent Hypergeometric Function | 497 |
| 16.2 | Integral Representation of Bessel Functions | 498 |
| 16.2.1 | Asymptotic Behavior of Bessel Functions | 502 |
| 16.3 | Problems | 505 |
| Part V Operators on Hilbert Spaces | | |
| 17 | Introductory Operator Theory | 511 |
| 17.1 | From Abstract to Integral and Differential Operators | 511 |
| 17.2 | Bounded Operators in Hilbert Spaces | 513 |
| 17.2.1 | Adjoints of Bounded Operators | 517 |
| 17.3 | Spectra of Linear Operators | 517 |
| 17.4 | Compact Sets | 519 |
| 17.4.1 | Compactness and Infinite Sequences | 521 |
| 17.5 | Compact Operators | 523 |
| 17.5.1 | Spectrum of Compact Operators | 527 |
| 17.6 | Spectral Theorem for Compact Operators | 527 |
| 17.6.1 | Compact Hermitian Operator | 529 |
| 17.6.2 | Compact Normal Operator | 531 |
| 17.7 | Resolvents | 534 |
| 17.8 | Problems | 539 |
| 18 | Integral Equations | 543 |
| 18.1 | Classification | 543 |
| 18.2 | Fredholm Integral Equations | 549 |
| 18.2.1 | Hermitian Kernel | 552 |
| 18.2.2 | Degenerate Kernels | 556 |
| 18.3 | Problems | 560 |
| 19 | Sturm-Liouville Systems | 563 |
| 19.1 | Compact-Resolvent Unbounded Operators | 563 |
| 19.2 | Sturm-Liouville Systems and SOLDEs | 569 |
| 19.3 | Asymptotic Behavior | 573 |
| 19.3.1 | Large Eigenvalues | 573 |
| 19.3.2 | Large Argument | 577 |
| 19.4 | Expansions in Terms of Eigenfunctions | 577 |
| 19.5 | Separation in Cartesian Coordinates | 579 |
| 19.5.1 | Rectangular Conducting Box | 579 |
| 19.5.2 | Heat Conduction in a Rectangular Plate | 581 |

| | | |
|--------|---|-----|
| 19.5.3 | Quantum Particle in a Box | 582 |
| 19.5.4 | Wave Guides | 584 |
| 19.6 | Separation in Cylindrical Coordinates | 586 |
| 19.6.1 | Conducting Cylindrical Can | 586 |
| 19.6.2 | Cylindrical Wave Guide | 588 |
| 19.6.3 | Current Distribution in a Circular Wire | 589 |
| 19.7 | Separation in Spherical Coordinates | 590 |
| 19.7.1 | Radial Part of Laplace's Equation | 591 |
| 19.7.2 | Helmholtz Equation in Spherical Coordinates | 593 |
| 19.7.3 | Quantum Particle in a Hard Sphere | 593 |
| 19.7.4 | Plane Wave Expansion | 594 |
| 19.8 | Problems | 595 |

Part VI Green's Functions

| | | |
|-----------|---|------------|
| 20 | Green's Functions in One Dimension | 605 |
| 20.1 | Calculation of Some Green's Functions | 606 |
| 20.2 | Formal Considerations | 610 |
| 20.2.1 | Second-Order Linear DOs | 614 |
| 20.2.2 | Self-adjoint SOLDOS | 616 |
| 20.3 | Green's Functions for SOLDOS | 617 |
| 20.3.1 | Properties of Green's Functions | 619 |
| 20.3.2 | Construction and Uniqueness of Green's Functions | 621 |
| 20.3.3 | Inhomogeneous BCs | 626 |
| 20.4 | Eigenfunction Expansion | 630 |
| 20.5 | Problems | 632 |
| 21 | Multidimensional Green's Functions: Formalism | 635 |
| 21.1 | Properties of Partial Differential Equations | 635 |
| 21.1.1 | Characteristic Hypersurfaces | 636 |
| 21.1.2 | Second-Order PDEs in m Dimensions | 640 |
| 21.2 | Multidimensional GFs and Delta Functions | 643 |
| 21.2.1 | Spherical Coordinates in m Dimensions | 645 |
| 21.2.2 | Green's Function for the Laplacian | 647 |
| 21.3 | Formal Development | 648 |
| 21.3.1 | General Properties | 648 |
| 21.3.2 | Fundamental (Singular) Solutions | 649 |
| 21.4 | Integral Equations and GFs | 652 |
| 21.5 | Perturbation Theory | 655 |
| 21.5.1 | The Nondegenerate Case | 659 |
| 21.5.2 | The Degenerate Case | 660 |
| 21.6 | Problems | 661 |
| 22 | Multidimensional Green's Functions: Applications | 665 |
| 22.1 | Elliptic Equations | 665 |
| 22.1.1 | The Dirichlet Boundary Value Problem | 665 |
| 22.1.2 | The Neumann Boundary Value Problem | 671 |
| 22.2 | Parabolic Equations | 673 |
| 22.3 | Hyperbolic Equations | 678 |
| 22.4 | The Fourier Transform Technique | 680 |

22.4.1 GF for the m -Dimensional Laplacian 681
 22.4.2 GF for the m -Dimensional Helmholtz Operator . . . 682
 22.4.3 GF for the m -Dimensional Diffusion Operator . . . 684
 22.4.4 GF for the m -Dimensional Wave Equation 685
 22.5 The Eigenfunction Expansion Technique 688
 22.6 Problems 693

Part VII Groups and Their Representations

23 Group Theory 701
 23.1 Groups 702
 23.2 Subgroups 705
 23.2.1 Direct Products 712
 23.3 Group Action 713
 23.4 The Symmetric Group S_n 715
 23.5 Problems 720

24 Representation of Groups 725
 24.1 Definitions and Examples 725
 24.2 Irreducible Representations 728
 24.3 Orthogonality Properties 732
 24.4 Analysis of Representations 737
 24.5 Group Algebra 740
 24.5.1 Group Algebra and Representations 740
 24.6 Relationship of Characters to Those of a Subgroup 743
 24.7 Irreducible Basis Functions 746
 24.8 Tensor Product of Representations 750
 24.8.1 Clebsch-Gordan Decomposition 753
 24.8.2 Irreducible Tensor Operators 756
 24.9 Problems 758

25 Representations of the Symmetric Group 761
 25.1 Analytic Construction 761
 25.2 Graphical Construction 764
 25.3 Graphical Construction of Characters 767
 25.4 Young Operators 771
 25.5 Products of Representations of S_n 774
 25.6 Problems 776

Part VIII Tensors and Manifolds

26 Tensors 781
 26.1 Tensors as Multilinear Maps 782
 26.2 Symmetries of Tensors 789
 26.3 Exterior Algebra 794
 26.3.1 Orientation 800
 26.4 Symplectic Vector Spaces 801
 26.5 Inner Product Revisited 804
 26.5.1 Subspaces 809
 26.5.2 Orthonormal Basis 812

| | | |
|--|---|------------|
| 26.5.3 | Inner Product on $\Lambda^p(\mathcal{V}, \mathcal{U})$ | 819 |
| 26.6 | The Hodge Star Operator | 820 |
| 26.7 | Problems | 823 |
| 27 | Clifford Algebras | 829 |
| 27.1 | Construction of Clifford Algebras | 830 |
| 27.1.1 | The Dirac Equation | 832 |
| 27.2 | General Properties of the Clifford Algebra | 834 |
| 27.2.1 | Homomorphism with Other Algebras | 837 |
| 27.2.2 | The Canonical Element | 838 |
| 27.2.3 | Center and Anticenter | 839 |
| 27.2.4 | Isomorphisms | 842 |
| 27.3 | General Classification of Clifford Algebras | 843 |
| 27.4 | The Clifford Algebras $\mathbf{C}_\mu^v(\mathbb{R})$ | 846 |
| 27.4.1 | Classification of $\mathbf{C}_n^0(\mathbb{R})$ and $\mathbf{C}_0^n(\mathbb{R})$ | 849 |
| 27.4.2 | Classification of $\mathbf{C}_\mu^v(\mathbb{R})$ | 851 |
| 27.4.3 | The Algebra $\mathbf{C}_3^1(\mathbb{R})$ | 852 |
| 27.5 | Problems | 856 |
| 28 | Analysis of Tensors | 859 |
| 28.1 | Differentiable Manifolds | 859 |
| 28.2 | Curves and Tangent Vectors | 866 |
| 28.3 | Differential of a Map | 872 |
| 28.4 | Tensor Fields on Manifolds | 876 |
| 28.4.1 | Vector Fields | 877 |
| 28.4.2 | Tensor Fields | 882 |
| 28.5 | Exterior Calculus | 888 |
| 28.6 | Integration on Manifolds | 897 |
| 28.7 | Symplectic Geometry | 901 |
| 28.8 | Problems | 909 |
| Part IX Lie Groups and Their Applications | | |
| 29 | Lie Groups and Lie Algebras | 915 |
| 29.1 | Lie Groups and Their Algebras | 915 |
| 29.1.1 | Group Action | 917 |
| 29.1.2 | Lie Algebra of a Lie Group | 920 |
| 29.1.3 | Invariant Forms | 927 |
| 29.1.4 | Infinitesimal Action | 928 |
| 29.1.5 | Integration on Lie Groups | 935 |
| 29.2 | An Outline of Lie Algebra Theory | 936 |
| 29.2.1 | The Lie Algebras $\mathfrak{o}(p, n - p)$ and $\mathfrak{p}(p, n - p)$ | 940 |
| 29.2.2 | Operations on Lie Algebras | 944 |
| 29.3 | Problems | 948 |
| 30 | Representation of Lie Groups and Lie Algebras | 953 |
| 30.1 | Representation of Compact Lie Groups | 953 |
| 30.2 | Representation of the General Linear Group | 963 |
| 30.3 | Representation of Lie Algebras | 966 |
| 30.3.1 | Representation of Subgroups of $GL(\mathcal{V})$ | 967 |

| | | |
|---------------------------------|--|-------------|
| 30.3.2 | Casimir Operators | 969 |
| 30.3.3 | Representation of $\mathfrak{so}(3)$ and $\mathfrak{so}(3, 1)$ | 972 |
| 30.3.4 | Representation of the Poincaré Algebra | 975 |
| 30.4 | Problems | 983 |
| 31 | Representation of Clifford Algebras | 987 |
| 31.1 | The Clifford Group | 987 |
| 31.2 | Spinors | 995 |
| 31.2.1 | Pauli Spin Matrices and Spinors | 997 |
| 31.2.2 | Spinors for $C_\mu^{\nu}(\mathbb{R})$ | 1001 |
| 31.2.3 | $C_3^1(\mathbb{R})$ Revisited | 1004 |
| 31.3 | Problems | 1006 |
| 32 | Lie Groups and Differential Equations | 1009 |
| 32.1 | Symmetries of Algebraic Equations | 1009 |
| 32.2 | Symmetry Groups of Differential Equations | 1014 |
| 32.2.1 | Prolongation of Functions | 1017 |
| 32.2.2 | Prolongation of Groups | 1021 |
| 32.2.3 | Prolongation of Vector Fields | 1022 |
| 32.3 | The Central Theorems | 1024 |
| 32.4 | Application to Some Known PDEs | 1029 |
| 32.4.1 | The Heat Equation | 1030 |
| 32.4.2 | The Wave Equation | 1034 |
| 32.5 | Application to ODEs | 1037 |
| 32.5.1 | First-Order ODEs | 1037 |
| 32.5.2 | Higher-Order ODEs | 1039 |
| 32.5.3 | DEs with Multiparameter Symmetries | 1040 |
| 32.6 | Problems | 1043 |
| 33 | Calculus of Variations, Symmetries, and Conservation Laws | 1047 |
| 33.1 | The Calculus of Variations | 1047 |
| 33.1.1 | Derivative for Hilbert Spaces | 1047 |
| 33.1.2 | Functional Derivative | 1050 |
| 33.1.3 | Variational Problems | 1053 |
| 33.1.4 | Divergence and Null Lagrangians | 1060 |
| 33.2 | Symmetry Groups of Variational Problems | 1062 |
| 33.3 | Conservation Laws and Noether's Theorem | 1065 |
| 33.4 | Application to Classical Field Theory | 1069 |
| 33.5 | Problems | 1073 |
| Part X Fiber Bundles | | |
| 34 | Fiber Bundles and Connections | 1079 |
| 34.1 | Principal Fiber Bundles | 1079 |
| 34.1.1 | Associated Bundles | 1084 |
| 34.2 | Connections in a PFB | 1086 |
| 34.2.1 | Local Expression for a Connection | 1087 |
| 34.2.2 | Parallelism | 1089 |
| 34.3 | Curvature Form | 1091 |
| 34.3.1 | Flat Connections | 1095 |

| | | |
|-----------|---|-------------|
| 34.3.2 | Matrix Structure Group | 1096 |
| 34.4 | Problems | 1097 |
| 35 | Gauge Theories | 1099 |
| 35.1 | Gauge Potentials and Fields | 1099 |
| 35.1.1 | Particle Fields | 1101 |
| 35.1.2 | Gauge Transformation | 1102 |
| 35.2 | Gauge-Invariant Lagrangians | 1105 |
| 35.3 | Construction of Gauge-Invariant Lagrangians | 1107 |
| 35.4 | Local Equations | 1112 |
| 35.5 | Problems | 1115 |
| 36 | Differential Geometry | 1117 |
| 36.1 | Connections in a Vector Bundle | 1117 |
| 36.2 | Linear Connections | 1120 |
| 36.2.1 | Covariant Derivative of Tensor Fields | 1123 |
| 36.2.2 | From Forms on P to Tensor Fields on M | 1125 |
| 36.2.3 | Component Expressions | 1128 |
| 36.2.4 | General Basis | 1132 |
| 36.3 | Geodesics | 1137 |
| 36.3.1 | Riemann Normal Coordinates | 1138 |
| 36.4 | Problems | 1140 |
| 37 | Riemannian Geometry | 1143 |
| 37.1 | The Metric Connection | 1143 |
| 37.1.1 | Orthogonal Bases | 1148 |
| 37.2 | Isometries and Killing Vector Fields | 1155 |
| 37.3 | Geodesic Deviation and Curvature | 1159 |
| 37.3.1 | Newtonian Gravity | 1161 |
| 37.4 | General Theory of Relativity | 1163 |
| 37.4.1 | Einstein's Equation | 1163 |
| 37.4.2 | Static Spherically Symmetric Solutions | 1167 |
| 37.4.3 | Schwarzschild Geodesics | 1169 |
| 37.5 | Problems | 1174 |
| | References | 1179 |
| | Index | 1181 |

List of Symbols

General

| | |
|--------------|---|
| \forall | for all (values of) |
| \exists | there exists (a values of) |
| <i>iff</i> | if and only if |
| $A \equiv B$ | A is identical to (equivalent to, defined as) B |

Set Theory

| | |
|-----------------------|--|
| \in | set theoretic membership sign: “belongs to” |
| \notin | set theoretic exclusion sign: “does not belong to” |
| \subset | subset sign |
| \subseteq | subset with the possibility of equality emphasized |
| \emptyset | empty set |
| \cup | union of sets |
| \cap | intersection of sets |
| $\sim A$ | complement of the set A |
| $A \times B$ | set of ordered pairs (a, b) with $a \in A$ and $b \in B$ |
| \simeq | equivalence relation |
| $[a]$ | equivalence class of a |
| id_X | identity map of the set X |
| \mathbb{N} | the set of natural (non-negative integer) numbers |
| \mathbb{Z} | the set of integers |
| \mathbb{Q} | the set of rational numbers |
| \mathbb{R} | the set of real numbers |
| \mathbb{R}^+ | the set of positive real numbers |
| \mathbb{C} | the set of complex numbers |
| \mathbb{H} | the set of quaternions |
| $f : A \rightarrow B$ | map f from set A to set B |
| $x \mapsto f(x)$ | x is mapped to $f(x)$ via the map f |
| $g \circ f$ | composition of the two maps f and g |

Vector Spaces

| | |
|---------------------------------|--|
| \mathcal{V} | a generic vector space |
| $ a\rangle$ | a generic vector labeled a |
| $\mathbb{C}^n, \mathbb{R}^n$ | complex (real) n -tuples |
| $\mathcal{M}^{m \times n}$ | $m \times n$ matrices |
| \mathbb{C}^∞ | absolutely convergent complex series |
| $\mathcal{P}^{\mathbb{C}}[t]$ | polynomials in t with complex coefficients |
| $\mathcal{P}^{\mathbb{R}}[t]$ | polynomials in t with real coefficients |
| $\mathcal{P}_n^{\mathbb{C}}[t]$ | complex polynomials of degree n or less |

| | |
|---------------------------------------|---|
| $\mathcal{C}^0(a, b)$ | continuous functions on real interval (a, b) |
| $\mathcal{C}^n(a, b)$ | n -times differentiable functions on real interval (a, b) |
| $\mathcal{C}^\infty(a, b)$ | infinitely differentiable functions on real interval (a, b) |
| $\text{Span}\{S\}$ | the span of a subset S of a vector space |
| $\langle a b \rangle$ | inner product of vectors $ a\rangle$ and $ b\rangle$ |
| $\ a\ $ | norm of the vector $ a\rangle$ |
| \oplus | direct sum of vectors or vector spaces |
| $\bigoplus_{k=1}^n$ | direct sum of n vectors or vector spaces |
| \mathcal{V}^* | dual of the vector space \mathcal{V} |
| $\langle a, \alpha \rangle$ | pairing of the vector $ a\rangle$ with its dual α |
| <i>Algebras</i> | |
| \mathcal{A} | a generic algebra |
| $\mathcal{L}(\mathcal{V})$ | the algebra of linear maps of the vector space \mathcal{V} ; same as $\text{End}(\mathcal{V})$ |
| $\text{End}(\mathcal{V})$ | the algebra of linear maps of the vector space \mathcal{V} ; same as $\mathcal{L}(\mathcal{V})$ |
| \oplus | direct sum of algebras |
| \oplus_V | direct sum of algebras only as vector spaces |
| \otimes | tensor product of algebras |
| $\mathcal{M}(\mathbb{F})$ | total matrix algebra over the field \mathbb{F} |
| $\mathcal{C}(\mathcal{V})$ | Clifford algebra of the inner-product space \mathcal{V} |
| \vee | Clifford product symbol |
| <i>Groups</i> | |
| S_n | symmetric group; group of permutations of $1, 2, \dots, n$ |
| $GL(\mathcal{V})$ | general linear group of the vector space \mathcal{V} |
| $GL(n, \mathbb{C})$ | general linear group of the vector space \mathbb{C}^n |
| $GL(n, \mathbb{R})$ | general linear group of the vector space \mathbb{R}^n |
| $SL(\mathcal{V})$ | special linear group; subgroup of $GL(\mathcal{V})$ with unit determinant |
| $O(n)$ | orthogonal group; group of orthogonal $n \times n$ matrices |
| $SO(n)$ | special orthogonal group; subgroup of $O(n)$ with unit determinant |
| $U(n)$ | unitary group; group of unitary $n \times n$ matrices |
| $SU(n)$ | special unitary group; subgroup of $U(n)$ with unit determinant |
| \mathfrak{g} | Lie algebra of the Lie group G |
| \cong | isomorphism of groups, vector spaces, and algebras |
| <i>Tensors</i> | |
| $\mathcal{T}_s^r(\mathcal{V})$ | set of tensors of type (r, s) in vector space \mathcal{V} |
| $\mathcal{S}^r(\mathcal{V})$ | set of symmetric tensors of type $(r, 0)$ in vector space \mathcal{V} |
| $\Lambda^p(\mathcal{V})$ | set of p -forms in vector space \mathcal{V} |
| $\Lambda^p(\mathcal{V}^*)$ | set of p -vectors in vector space \mathcal{V} |
| \wedge | wedge (exterior) product symbol |
| $\Lambda^p(\mathcal{V}, \mathcal{U})$ | set of p -forms in \mathcal{V} with values in vector space \mathcal{U} |
| $F^\infty(P)$ | set of infinitely differentiable functions at point P of a manifold |
| $\mathcal{T}_P(M)$ | set of vectors tangent to manifold M at point $P \in M$ |

| | |
|---------------------|---|
| $T(M)$ | tangent bundle of the manifold M |
| $T^*(M)$ | cotangent bundle of the manifold M |
| $\mathcal{X}(M)$ | set of vector fields on the manifold M |
| $\exp(t\mathbf{X})$ | flow of the vector field \mathbf{X} parametrized by t |
| $T_s^r(M)$ | set of tensor fields of type (r, s) in the manifold M |

This introductory chapter gathers together some of the most basic tools and notions that are used throughout the book. It also introduces some common vocabulary and notations used in modern mathematical physics literature. Readers familiar with such concepts as sets, maps, equivalence relations, and metric spaces may wish to skip this chapter.

1.1 Sets

Modern mathematics starts with the basic (and undefinable) concept of **set**. We think of a set as a structureless family, or collection, of objects. We speak, for example, of the set of students in a college, of men in a city, of women working for a corporation, of vectors in space, of points in a plane, or of events in the continuum of space-time. Each member a of a set A is called an **element** of that set. This relation is denoted by $a \in A$ (read “ a is an element of A ” or “ a belongs to A ”), and its negation by $a \notin A$. Sometimes a is called a **point** of the set A to emphasize a geometric connotation.

concept of set
elaborated

A set is usually designated by enumeration of its elements between braces. For example, $\{2, 4, 6, 8\}$ represents the set consisting of the first four even natural numbers; $\{0, \pm 1, \pm 2, \pm 3, \dots\}$ is the set of all integers; $\{1, x, x^2, x^3, \dots\}$ is the set of all nonnegative powers of x ; and $\{1, i, -1, -i\}$ is the set of the four complex fourth roots of unity. In many cases, a set is defined by a (mathematical) statement that holds for all of its elements. Such a set is generally denoted by $\{x \mid P(x)\}$ and read “the set of all x ’s such that $P(x)$ is true.” The foregoing examples of sets can be written alternatively as follows:

$$\{n \mid n \text{ is even and } 1 < n < 9\}$$

$$\{\pm n \mid n \text{ is a natural number}\}$$

$$\{y \mid y = x^n \text{ and } n \text{ is a natural number}\}$$

$$\{z \mid z^4 = 1 \text{ and } z \text{ is a complex number}\}.$$

In a frequently used shorthand notation, the last two sets can be abbreviated as $\{x^n \mid n \geq 0 \text{ and } n \text{ is an integer}\}$ and $\{z \in \mathbb{C} \mid z^4 = 1\}$. Similarly, the unit circle can be denoted by $\{z \in \mathbb{C} \mid |z| = 1\}$, the closed interval $[a, b]$ as $\{x \mid a \leq x \leq b\}$, the open interval (a, b) as $\{x \mid a < x < b\}$, and the set of all nonnegative powers of x as $\{x^n\}_{n=0}^{\infty}$ or $\{x^n\}_{n \in \mathbb{N}}$, where \mathbb{N} is the set of natural numbers (i.e., nonnegative integers). This last notation will be used frequently in this book. A set with a single element is called a **singleton**.

If $a \in A$ whenever $a \in B$, we say that B is a **subset** of A and write $B \subset A$ or $A \supset B$. If $B \subset A$ and $A \subset B$, then $A = B$. If $B \subset A$ and $A \neq B$, then B is called a **proper subset** of A . The set defined by $\{a \mid a \neq a\}$ is called the **empty set** and is denoted by \emptyset . Clearly, \emptyset contains no elements and is a subset of any arbitrary set. The collection of all subsets (including \emptyset) of a set A is denoted by 2^A . The reason for this notation is that the number of subsets of a set containing n elements is 2^n when n is finite (Problem 1.1).

If A and B are sets, their **union**, denoted by $A \cup B$, is the set containing all elements that belong to A or B or both. The **intersection** of the sets A and B , denoted by $A \cap B$, is the set containing all elements belonging to both A and B . If $\{B_\alpha\}_{\alpha \in I}$ is a collection of sets,¹ we denote their union by $\bigcup_{\alpha \in I} B_\alpha$ and their intersection by $\bigcap_{\alpha \in I} B_\alpha$.

The **complement** of a set A is denoted by $\sim A$ and defined as

$$\sim A \equiv \{a \mid a \notin A\}.$$

The complement of B in A (or their difference) is

$$A \sim B \equiv \{a \mid a \in A \text{ and } a \notin B\}.$$

In any application of set theory there is an underlying **universal set** whose subsets are the objects of study. This universal set is usually clear from the context. For example, in the study of the properties of integers, the set of integers, denoted by \mathbb{Z} , is the universal set. The set of reals, \mathbb{R} , is the universal set in real analysis, and the set of complex numbers, \mathbb{C} , is the universal set in complex analysis. To emphasize the presence of a universal set X , one can write $X \sim A$ instead of $\sim A$.

From two given sets A and B , it is possible to form the **Cartesian product** of A and B , denoted by $A \times B$, which is the set of **ordered pairs** (a, b) , where $a \in A$ and $b \in B$. This is expressed in set-theoretic notation as

$$A \times B = \{(a, b) \mid a \in A \text{ and } b \in B\}.$$

We can generalize this to an arbitrary number of sets. If A_1, A_2, \dots, A_n are sets, then the Cartesian product of these sets is

$$A_1 \times A_2 \times \cdots \times A_n = \{(a_1, a_2, \dots, a_n) \mid a_i \in A_i\},$$

¹Here I is an index set—or a counting set—with its typical element denoted by α . In most cases, I is the set of (nonnegative) integers, but, in principle, it can be any set, for example, the set of real numbers.

which is a set of ordered n -tuples. If $A_1 = A_2 = \dots = A_n = A$, then we write A^n instead of $A \times A \times \dots \times A$, and

$$A^n = \{(a_1, a_2, \dots, a_n) \mid a_i \in A\}.$$

The most familiar example of a Cartesian product occurs when $A = \mathbb{R}$. Then \mathbb{R}^2 is the set of pairs (x_1, x_2) with $x_1, x_2 \in \mathbb{R}$. This is simply the points in the plane. Similarly, \mathbb{R}^3 is the set of triplets (x_1, x_2, x_3) , or the points in space, and $\mathbb{R}^n = \{(x_1, x_2, \dots, x_n) \mid x_i \in \mathbb{R}\}$ is the set of real n -tuples.

1.1.1 Equivalence Relations

There are many instances in which the elements of a set are naturally grouped together. For example, all vector potentials that differ by the gradient of a scalar function can be grouped together because they all give the same magnetic field. Similarly, all quantum state functions (of unit “length”) that differ by a multiplicative complex number of unit length can be grouped together because they all represent the same physical state. The abstraction of these ideas is summarized in the following definition.

Definition 1.1.1 Let A be a set. A **relation** on A is a comparison test between members of ordered pairs of elements of A . If the pair $(a, b) \in A \times A$ passes this test, we write $a \triangleright b$ and read “ a is related to b ”. An **equivalence relation** on A is a relation that has the following properties:

relation and equivalence relation

$$a \triangleright a \quad \forall a \in A, \quad (\text{reflexivity})$$

$$a \triangleright b \Rightarrow b \triangleright a \quad a, b \in A, \quad (\text{symmetry})$$

$$a \triangleright b, \text{ and } b \triangleright c \Rightarrow a \triangleright c \quad a, b, c \in A, \quad (\text{transitivity}).$$

When $a \triangleright b$, we say that “ a is equivalent to b ”. The set $\llbracket a \rrbracket = \{b \in A \mid b \triangleright a\}$ of all elements that are equivalent to a is called the **equivalence class** of a .

equivalence class

The reader may verify the following property of equivalence relations.

Proposition 1.1.2 *If \triangleright is an equivalence relation on A and $a, b \in A$, then either $\llbracket a \rrbracket \cap \llbracket b \rrbracket = \emptyset$ or $\llbracket a \rrbracket = \llbracket b \rrbracket$.*

Therefore, $a' \in \llbracket a \rrbracket$ implies that $\llbracket a' \rrbracket = \llbracket a \rrbracket$. In other words, any element of an equivalence class can be chosen to be a **representative** of that class. Because of the symmetry of equivalence relations, sometimes we denote them by \bowtie .

representative of an equivalence class

Example 1.1.3 Let A be the set of human beings. Let $a \triangleright b$ be interpreted as “ a is older than b .” Then clearly, \triangleright is a relation but not an equivalence relation. On the other hand, if we interpret $a \triangleright b$ as “ a and b live in the same city,” then \triangleright is an equivalence relation, as the reader may check. The equivalence class of a is the population of that city.

Let V be the set of vector potentials. Write $\mathbf{A} \triangleright \mathbf{A}'$ if $\mathbf{A} - \mathbf{A}' = \nabla f$ for some function f . The reader may verify that \triangleright is an equivalence relation, and that $[\mathbf{A}]$ is the set of all vector potentials giving rise to the same magnetic field.

Let the underlying set be $\mathbb{Z} \times (\mathbb{Z} \sim \{0\})$. Say “ (a, b) is related to (c, d) ” if $ad = bc$. Then this relation is an equivalence relation. Furthermore, $[(a, b)]$ can be identified as the ratio a/b .

Definition 1.1.4 Let A be a set and $\{B_\alpha\}$ a collection of subsets of A . We say that $\{B_\alpha\}$ is a **partition** of A , or $\{B_\alpha\}$ **partitions** A , if the B_α 's are disjoint, i.e., have no element in common, and $\bigcup_\alpha B_\alpha = A$.

Now consider the collection $\{[a] \mid a \in A\}$ of all equivalence classes of A . These classes are disjoint, and evidently their union covers all of A . Therefore, *the collection of equivalence classes of A is a partition of A* . This collection is denoted by A/\triangleright and is called the **quotient set** or **factor set** of A under the equivalence relation \triangleright .

Example 1.1.5 Let the underlying set be \mathbb{R}^3 . Define an equivalence relation on \mathbb{R}^3 by saying that $P_1 \in \mathbb{R}^3$ and $P_2 \in \mathbb{R}^3$ are equivalent if they lie on the same line passing through the origin. Then $\mathbb{R}^3/\triangleright$ is the set of all lines in space passing through the origin. If we choose the unit vector with positive third coordinate along a given line as the representative of that line, then $\mathbb{R}^3/\triangleright$, called the **projective space** associated with \mathbb{R}^3 , is almost (but not quite) the same as the upper unit hemisphere. The difference is that any two points on the edge of the hemisphere which lie on the same diameter ought to be identified as the same to turn it into the projective space.

On the set \mathbb{Z} of integers, define a relation by writing $m \triangleright n$ for $m, n \in \mathbb{Z}$ if $m - n$ is divisible by k , where k is a fixed integer. Then \triangleright is not only a relation, but an equivalence relation. In this case, we have

$$\mathbb{Z}/\triangleright = \{[0], [1], \dots, [k-1]\},$$

as the reader is urged to verify.

For the equivalence relation defined on $\mathbb{Z} \times (\mathbb{Z} \sim \{0\})$ of Example 1.1.3, the set $(\mathbb{Z} \times (\mathbb{Z} \sim \{0\}))/\triangleright$ can be identified with \mathbb{Q} , the set of rational numbers.

1.2 Maps

To communicate between sets, one introduces the concept of a map. A **map** f from a set X to a set Y , denoted by $f : X \rightarrow Y$ or $X \xrightarrow{f} Y$, is a correspondence between elements of X and those of Y in which all the elements of X participate, and each element of X corresponds to only one element of Y (see Fig. 1.1). If $y \in Y$ is the element that corresponds to $x \in X$ via the map f , we write

$$y = f(x) \quad \text{or} \quad x \mapsto f(x) \quad \text{or} \quad x \xrightarrow{f} y$$

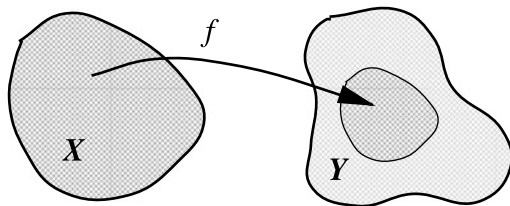

Fig. 1.1 The map f maps all of the set X onto a subset of Y . The shaded area in Y is $f(X)$, the range of f

and call $f(x)$ the **image** of x under f . Thus, by the definition of map, $x \in X$ can have only one image. The set X is called the **domain**, and Y the **codomain** or the **target space**. Two maps $f : X \rightarrow Y$ and $g : X \rightarrow Y$ are said to be equal if $f(x) = g(x)$ for all $x \in X$.

function

Definition 1.2.1 A map whose codomain is the set of real numbers \mathbb{R} or the set of complex numbers \mathbb{C} is commonly called a **function**.

A special map that applies to all sets A is $\text{id}_A : A \rightarrow A$, called the **identity map** of A , and defined by

identity map

$$\text{id}_A(a) = a \quad \forall a \in A.$$

The **graph** Γ_f of a map $f : A \rightarrow B$ is a subset of $A \times B$ defined by

graph of a map

$$\Gamma_f = \{(a, f(a)) \mid a \in A\} \subset A \times B.$$

This general definition reduces to the ordinary graphs encountered in algebra and calculus where $A = B = \mathbb{R}$ and $A \times B$ is the xy -plane.

If A is a subset of X , we call $f(A) = \{f(x) \mid x \in A\}$ the **image** of A . Similarly, if $B \subset f(X)$, we call $f^{-1}(B) = \{x \in X \mid f(x) \in B\}$ the **inverse image**, or **preimage**, of B . In words, $f^{-1}(B)$ consists of all elements in X whose images are in $B \subset Y$. If B consists of a single element b , then $f^{-1}(b) = \{x \in X \mid f(x) = b\}$ consists of all elements of X that are mapped to b . Note that it is possible for many points of X to have the same image in Y . The subset $f(X)$ of the codomain of a map f is called the **range** of f (see Fig. 1.1).

preimage

If $f : X \rightarrow Y$ and $g : Y \rightarrow W$, then the mapping $h : X \rightarrow W$ given by $h(x) = g(f(x))$ is called the **composition** of f and g , and is denoted by $h = g \circ f$ (see Fig. 1.2).² It is easy to verify that

composition of two maps

$$f \circ \text{id}_X = f = \text{id}_Y \circ f.$$

If $f(x_1) = f(x_2)$ implies that $x_1 = x_2$, we call f **injective**, or **one-to-one** (denoted 1-1). For an injective map only one element of X corresponds to an element of Y . If $f(X) = Y$, the mapping is said to be **surjective**, or

injection, surjection, and bijection, or 1-1 correspondence

²Note the importance of the order in which the composition is written. The reverse order may not even exist.

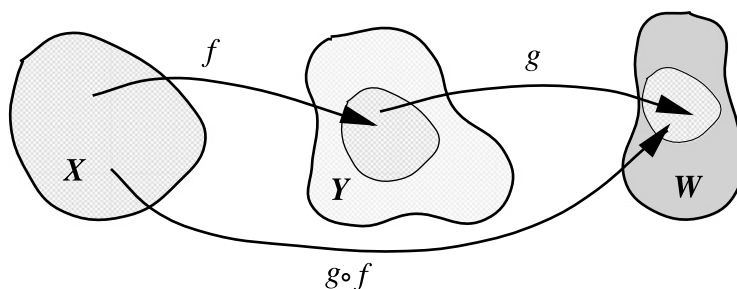

Fig. 1.2 The composition of two maps is another map

onto. A map that is both injective and surjective is said to be **bijective**, or to be a **one-to-one correspondence**. Two sets that are in one-to-one correspondence, have, by definition, the same number of elements. If $f : X \rightarrow Y$ is a bijection from X onto Y , then for each $y \in Y$ there is one and only one element x in X for which $f(x) = y$. Thus, there is a mapping $f^{-1} : Y \rightarrow X$ given by $f^{-1}(y) = x$, where x is the unique element such that $f(x) = y$. This mapping is called the **inverse** of f . The inverse of f is also identified as the map that satisfies $f \circ f^{-1} = \text{id}_Y$ and $f^{-1} \circ f = \text{id}_X$. For example, one can easily verify that $\ln^{-1} = \exp$ and $\exp^{-1} = \ln$, because $\ln(e^x) = x$ and $e^{\ln x} = x$.

inverse of a map

quotient or factor map

Given a map $f : X \rightarrow Y$, we can define a relation \bowtie on X by saying $x_1 \bowtie x_2$ if $f(x_1) = f(x_2)$. The reader may check that this is in fact an *equivalence* relation. The equivalence classes are subsets of X all of whose elements map to the same point in Y . In fact, $\llbracket x \rrbracket = f^{-1}(f(x))$. Corresponding to f , there is a map $\tilde{f} : X/\bowtie \rightarrow Y$, called **quotient map** or **factor map**, given by $\tilde{f}(\llbracket x \rrbracket) = f(x)$. This map is injective because if $\tilde{f}(\llbracket x_1 \rrbracket) = \tilde{f}(\llbracket x_2 \rrbracket)$, then $f(x_1) = f(x_2)$, so x_1 and x_2 belong to the same equivalence class; therefore, $\llbracket x_1 \rrbracket = \llbracket x_2 \rrbracket$. It follows that

Proposition 1.2.2 *The map $\tilde{f} : X/\bowtie \rightarrow f(X)$ is bijective.*

If f and g are both bijections with inverses f^{-1} and g^{-1} , respectively, then $g \circ f$ also has an inverse, and verifying that $(g \circ f)^{-1} = f^{-1} \circ g^{-1}$ is straightforward.

Example 1.2.3 As an example of the preimage of a set, consider the sine and cosine functions: $\sin : \mathbb{R} \rightarrow \mathbb{R}$ and $\cos : \mathbb{R} \rightarrow \mathbb{R}$. Then it should be clear that

$$\sin^{-1} 0 = \{n\pi\}_{n=-\infty}^{\infty}, \quad \cos^{-1} 0 = \left\{ \frac{\pi}{2} + n\pi \right\}_{n=-\infty}^{\infty}.$$

Similarly, $\sin^{-1}[0, \frac{1}{2}]$, the preimage of the closed interval $[0, \frac{1}{2}] \subset \mathbb{R}$, consists of all the intervals on the x -axis marked by heavy line segments in Fig. 1.3, i.e., all the points whose sine lies between 0 and $\frac{1}{2}$.

Example 1.2.4 Let X be any set on which an equivalence relation \bowtie is defined. Then there is a natural map π , called **projection** $\pi : X \rightarrow X/\bowtie$

projection

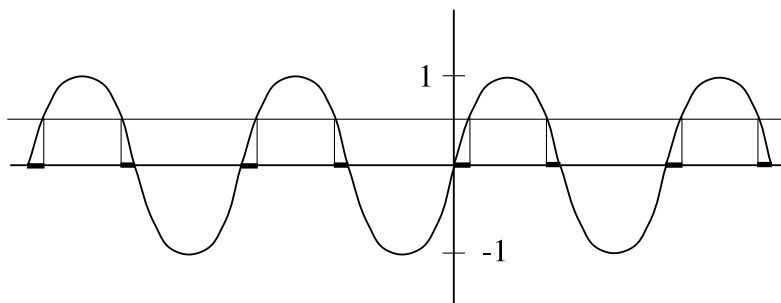

Fig. 1.3 The union of all the intervals on the x -axis marked by heavy line segments is $\sin^{-1}[0, \frac{1}{2}]$

given by $\pi(x) = \llbracket x \rrbracket$. This map is obviously surjective, but not injective, as $\pi(y) = \pi(x)$ if $y \bowtie x$. It becomes injective only if the equivalence relation becomes the identity map: $\bowtie = \text{id}_X$. Then the map becomes bijective, and we write $X \cong X/\text{id}_X$.

Example 1.2.5 As further examples of maps, we consider functions $f : \mathbb{R} \rightarrow \mathbb{R}$ studied in calculus. The two functions $f : \mathbb{R} \rightarrow \mathbb{R}$ and $g : \mathbb{R} \rightarrow (-1, +1)$ given, respectively, by $f(x) = x^3$ and $g(x) = \tanh x$ are bijective. The latter function, by the way, shows that there are as many points in the whole real line as there are in the interval $(-1, +1)$. If we denote the set of positive real numbers by \mathbb{R}^+ , then the function $f : \mathbb{R} \rightarrow \mathbb{R}^+$ given by $f(x) = x^2$ is surjective but not injective (both x and $-x$ map to x^2). The function $g : \mathbb{R}^+ \rightarrow \mathbb{R}$ given by the same rule, $g(x) = x^2$, is injective but not surjective. On the other hand, $h : \mathbb{R}^+ \rightarrow \mathbb{R}^+$ again given by $h(x) = x^2$ is bijective, but $u : \mathbb{R} \rightarrow \mathbb{R}$ given by the same rule is neither injective nor surjective.

injectivity and surjectivity depend on the domain and codomain

Let $\mathcal{M}^{n \times n}$ denote the set of $n \times n$ real matrices. Define a function $\det : \mathcal{M}^{n \times n} \rightarrow \mathbb{R}$ by $\det(A) = \det A$. This function is clearly surjective (why?) but not injective. The set of all matrices whose determinant is 1 is $\det^{-1}(1)$. Such matrices occur frequently in physical applications.

Another example of interest is $f : \mathbb{C} \rightarrow \mathbb{R}$ given by $f(z) = |z|$. This function is also neither injective nor surjective. Here $f^{-1}(1)$ is the **unit circle**, the circle of radius 1 in the complex plane. It is clear that $f(\mathbb{C}) = \{0\} \cup \mathbb{R}^+$. Furthermore, f induces an equivalence relation on \mathbb{C} : $z_1 \bowtie z_2$ if z_1 and z_2 belong to the same circle. Then \mathbb{C}/\bowtie is the set of circles centered at the origin of the complex plane and $\tilde{f} : \mathbb{C}/\bowtie \rightarrow \{0\} \cup \mathbb{R}^+$ is bijective, associating each circle to its radius.

unit circle

The domain of a map can be a Cartesian product of a set, as in $f : X \times X \rightarrow Y$. Two specific cases are worthy of mention. The first is when $Y = \mathbb{R}$. An example of this case is the dot product on vectors. Thus, if X is the set of vectors in space, we can define $f(\mathbf{a}, \mathbf{b}) = \mathbf{a} \cdot \mathbf{b}$. The second case is when $Y = X$. Then f is called a **binary operation** on X , whereby an element in X is associated with two elements in X . For instance, let $X = \mathbb{Z}$, the set of all integers; then the function $f : \mathbb{Z} \times \mathbb{Z} \rightarrow \mathbb{Z}$ defined by $f(m, n) = mn$ is

binary operation

the binary operation of multiplication of integers. Similarly, $g : \mathbb{R} \times \mathbb{R} \rightarrow \mathbb{R}$ given by $g(x, y) = x + y$ is the binary operation of addition of real numbers.

1.3 Metric Spaces

Although sets are at the root of modern mathematics, by themselves they are only of formal and abstract interest. To make sets useful, it is necessary to introduce some structures on them. There are two general procedures for the implementation of such structures. These are the abstractions of the two major branches of mathematics—algebra and analysis.

We can turn a set into an algebraic structure by introducing a binary operation on it. For example, a vector space consists, among other things, of the binary operation of vector addition. A group is, among other things, a set together with the binary operation of “multiplication”. There are many other examples of algebraic systems, and they constitute the rich subject of algebra.

When analysis, the other branch of mathematics, is abstracted using the concept of sets, it leads to topology, in which the concept of continuity plays a central role. This is also a rich subject with far-reaching implications and applications. We shall not go into any details of these two areas of mathematics. Although some algebraic systems will be discussed and the ideas of limit and continuity will be used in the sequel, this will be done in an intuitive fashion, by introducing and employing the concepts when they are needed. On the other hand, some general concepts will be introduced when they require minimum prerequisites. One of these is a metric space:

Definition 1.3.1 A **metric space** is a set X together with a real-valued function $d : X \times X \rightarrow \mathbb{R}$ such that

- (a) $d(x, y) \geq 0 \forall x, y$, and $d(x, y) = 0$ iff $x = y$.
- (b) $d(x, y) = d(y, x)$ (symmetry).
- (c) $d(x, y) \leq d(x, z) + d(z, y)$ (the triangle inequality).

It is worthwhile to point out that X is a completely arbitrary set and needs no other structure. In this respect, Definition 1.3.1 is very broad and encompasses many different situations, as the following examples will show. Before examining the examples, note that the function d defined above is the abstraction of the notion of distance: (a) says that the distance between any two points is always nonnegative and is zero only if the two points coincide; (b) says that the distance between two points does not change if the two points are interchanged; (c) states the known fact that the sum of the lengths of two sides of a triangle is always greater than or equal to the length of the third side.

The fact that the distance between two points of a set is positive and real is a property of a **Euclidean** metric space. In relativity, on the other hand, one has to deal with the possibility of a *Minkowskian* metric space for which distance (squared) is negative.

Euclidean and
Minkowskian metric
spaces

Example 1.3.2 Here are some examples of metric spaces:

1. Let $X = \mathbb{Q}$, the set of rational numbers, and define $d(x, y) = |x - y|$.
2. Let $X = \mathbb{R}$, and again define $d(x, y) = |x - y|$.
3. Let X consist of the points on the surface of a sphere. We can define two distance functions on X . Let $d_1(P, Q)$ be the length of the chord joining P and Q on the sphere. We can also define another metric, $d_2(P, Q)$, as the length of the arc of the great circle passing through points P and Q on the surface of the sphere. It is not hard to convince oneself that d_1 and d_2 satisfy all the properties of a metric function. Note that for d_2 , if two of the three points are the poles of the sphere, then the triangle inequality becomes an equality.
4. Let $\mathcal{C}^0[a, b]$ denote the set of continuous real-valued functions on the closed interval $[a, b]$. We can define $d(f, g) = \int_a^b |f(x) - g(x)| dx$ for $f, g \in \mathcal{C}^0(a, b)$.
5. Let $\mathcal{C}_B(a, b)$ denote the set of *bounded* continuous real-valued functions on the closed interval $[a, b]$. We then define

$$d(f, g) = \max_{x \in [a, b]} \{|f(x) - g(x)|\} \quad \text{for } f, g \in \mathcal{C}_B(a, b).$$

This notation says: Take the absolute value of the difference in f and g at all x in the interval $[a, b]$ and then pick the maximum of all these values.

The metric function creates a natural setting in which to test the “closeness” of points in a metric space. One occasion on which the idea of closeness becomes essential is in the study of a sequence. A **sequence** is a mapping $s : \mathbb{N} \rightarrow X$ from the set of natural numbers \mathbb{N} into the metric space X . Such a mapping associates with a positive integer n a point $s(n)$ of the metric space X . It is customary to write s_n (or x_n to match the symbol X) instead of $s(n)$ and to enumerate the values of the function by writing $\{x_n\}_{n=1}^{\infty}$.

sequence defined

Knowledge of the behavior of a sequence for large values of n is of fundamental importance. In particular, it is important to know whether a sequence approaches a finite value as n increases.

convergence defined

Definition 1.3.3 Suppose that for some x and for any positive real number ϵ , there exists a natural number N such that $d(x_n, x) < \epsilon$ whenever $n > N$. Then we say that the sequence $\{x_n\}_{n=1}^{\infty}$ **converges** to x and write $\lim_{n \rightarrow \infty} d(x_n, x) = 0$ or $d(x_n, x) \rightarrow 0$ or simply $x_n \rightarrow x$.

It may not be possible to test directly for the convergence of a given sequence because this requires a knowledge of the limit point x . However, it is possible to do the next best thing—to see whether the points of the sequence get closer and closer as n gets larger and larger.

Definition 1.3.4 A **Cauchy sequence** is a sequence for which

Cauchy sequence

$$\lim_{m, n \rightarrow \infty} d(x_m, x_n) = 0.$$

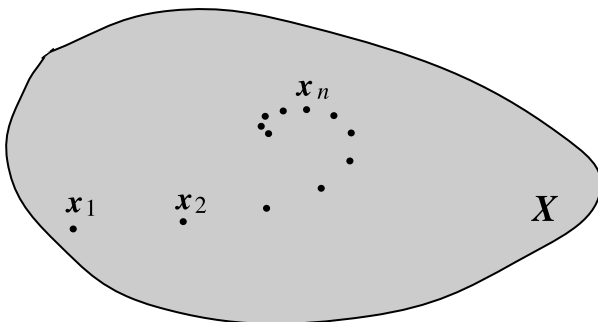

Fig. 1.4 The distance between the elements of a Cauchy sequence gets smaller and smaller

Figure 1.4 shows a Cauchy sequence.

We can test directly whether or not a sequence is Cauchy. However, the fact that a sequence is Cauchy does not guarantee that it converges. For example, let the metric space be the set of rational numbers \mathbb{Q} with the metric function $d(x, y) = |x - y|$, and consider the sequence $\{x_n\}_{n=1}^{\infty}$ where $x_n = \sum_{k=1}^n (-1)^{k+1}/k$. It is clear that x_n is a rational number for any n . Problem 1.7 shows how to prove that $|x_m - x_n| \rightarrow 0$. Thus, the sequence is Cauchy. However, it is probably known to the reader that $\lim_{n \rightarrow \infty} x_n = \ln 2$, which is not a rational number.

Definition 1.3.5 A metric space in which every Cauchy sequence converges is called a **complete metric space**.

Complete metric spaces play a crucial role in modern analysis. The preceding example shows that \mathbb{Q} is not a complete metric space. However, if the limit points of all Cauchy sequences are added to \mathbb{Q} , the resulting space becomes complete. This complete space is, of course, the real number system \mathbb{R} . It turns out that any incomplete metric space can be “enlarged” to a complete metric space.

1.4 Cardinality

The process of counting is a one-to-one comparison of one set with another. If two sets are in one-to-one correspondence, they are said to have the same **cardinality**. Two sets with the same cardinality essentially have the same “number” of elements. The set $F_n = \{1, 2, \dots, n\}$ is finite and has cardinality n . Any set from which there is a bijection onto F_n is said to be finite with n elements.

Historical Notes

Although some steps had been taken before him in the direction of a definitive theory of sets, the creator of the theory of sets is considered to be **Georg Cantor** (1845–1918), who was born in Russia of Danish-Jewish parentage but moved to Germany with his parents. His father urged him to study engineering, and Cantor entered the University of Berlin in 1863 with that intention. There he came under the influence of Weierstrass and turned to

pure mathematics. He became Privatdozent at Halle in 1869 and professor in 1879. When he was twenty-nine he published his first revolutionary paper on the theory of infinite sets in the *Journal für Mathematik*. Although some of its propositions were deemed faulty by the older mathematicians, its overall originality and brilliance attracted attention. He continued to publish papers on the theory of sets and on transfinite numbers until 1897. One of Cantor's main concerns was to differentiate among infinite sets by "size" and, like Bolzano before him, he decided that one-to-one correspondence should be the basic principle. In his correspondence with Dedekind in 1873, Cantor posed the question of whether the set of real numbers can be put into one-to-one correspondence with the integers, and some weeks later he answered in the negative. He gave two proofs. The first is more complicated than the second, which is the one most often used today. In 1874 Cantor occupied himself with the equivalence of the points of a line and the points of \mathbb{R}^n and sought to prove that a one-to-one correspondence between these two sets was impossible. Three years later he proved that there is such a correspondence. He wrote to Dedekind, "I see it but I do not believe it." He later showed that given any set, it is always possible to create a new set, the set of subsets of the given set, whose cardinal number is larger than that of the given set. For the natural numbers \mathbb{N} , whose cardinality is denoted by \aleph_0 , the cardinal number of the set of subsets is denoted by 2^{\aleph_0} . Cantor proved that $2^{\aleph_0} = c$, where c is the cardinal number of the continuum; i.e., the set of real numbers.

Cantor's work, which resolved age-old problems and reversed much previous thought, could hardly be expected to receive immediate acceptance. His ideas on transfinite ordinal and cardinal numbers aroused the hostility of the powerful Leopold Kronecker, who attacked Cantor's theory savagely over more than a decade, repeatedly preventing Cantor from obtaining a more prominent appointment in Berlin. Though Kronecker died in 1891, his attacks left mathematicians suspicious of Cantor's work. Poincaré referred to set theory as an interesting "pathological case." He also predicted that "Later generations will regard [Cantor's] *Mengenlehre* as a disease from which one has recovered." At one time Cantor suffered a nervous breakdown, but resumed work in 1887.

Many prominent mathematicians, however, were impressed by the uses to which the new theory had already been put in analysis, measure theory, and topology. Hilbert spread Cantor's ideas in Germany, and in 1926 said, "No one shall expel us from the paradise which Cantor created for us." He praised Cantor's transfinite arithmetic as "the most astonishing product of mathematical thought, one of the most beautiful realizations of human activity in the domain of the purely intelligible." Bertrand Russell described Cantor's work as "probably the greatest of which the age can boast." The subsequent utility of Cantor's work in formalizing mathematics—a movement largely led by Hilbert—seems at odds with Cantor's Platonic view that the greater importance of his work was in its implications for metaphysics and theology. That his work could be so seamlessly diverted from the goals intended by its creator is strong testimony to its objectivity and craftsmanship.



Georg Cantor 1845–1918

Now consider the set of natural numbers $\mathbb{N} = \{1, 2, 3, \dots\}$. If there exists a bijection between a set A and \mathbb{N} , then A is said to be **countably infinite**. Some examples of countably infinite sets are the set of all integers, the set of even natural numbers, the set of odd natural numbers, the set of all prime numbers, and the set of energy levels of the bound states of a hydrogen atom.

countably infinite

It may seem surprising that a subset (such as the set of all even numbers) can be put into one-to-one correspondence with the full set (the set of all natural numbers); however, this is a property shared by all *infinite* sets. In fact, sometimes infinite sets are *defined* as those sets that are in one-to-one correspondence with at least one of their proper subsets. It is also astonishing to discover that there are as many rational numbers as there are natural numbers. After all, there are infinitely many rational numbers just in the interval $(0, 1)$ —or between any two distinct real numbers.³

³The proof involves writing m/n as the mn th entry in an $\infty \times \infty$ matrix and starting the "count" with the $(1, 1)$ entry, going to the right to $(1, 2)$, then diagonally to $(2, 1)$,

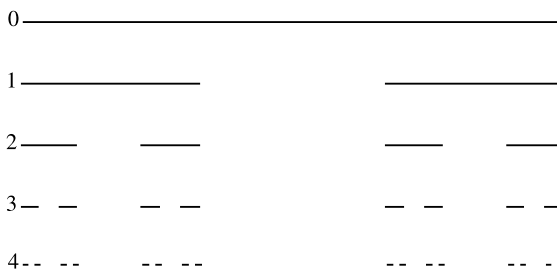

Fig. 1.5 The Cantor set after one, two, three, and four “dissections”

uncountable sets

Sets that are neither finite nor countably infinite are said to be **uncountable**. In some sense they are “more infinite” than any countable set. Examples of uncountable sets are the points in the interval $(-1, +1)$, the real numbers, the points in a plane, and the points in space. It can be shown that these sets have the same cardinality: There are as many points in three-dimensional space—the whole universe—as there are in the interval $(-1, +1)$ or in any other finite interval.

Cantor set constructed

Cardinality is a very intricate mathematical notion with many surprising results. Consider the interval $[0, 1]$. Remove the open interval $(\frac{1}{3}, \frac{2}{3})$ from its middle (leaving the points $\frac{1}{3}$ and $\frac{2}{3}$ behind). From the remaining portion, $[0, \frac{1}{3}] \cup [\frac{2}{3}, 1]$, remove the two middle thirds; the remaining portion will then be

$$\left[0, \frac{1}{9}\right] \cup \left[\frac{2}{9}, \frac{1}{3}\right] \cup \left[\frac{2}{3}, \frac{7}{9}\right] \cup \left[\frac{8}{9}, 1\right]$$

(see Fig. 1.5). Do this indefinitely. What is the cardinality of the remaining set, which is called the **Cantor set**? Intuitively we expect hardly anything to be left. We might persuade ourselves into accepting the fact that the number of points remaining is at most infinite but countable. The surprising fact is that the cardinality is that of the continuum! Thus, after removal of infinitely many middle thirds, the set that remains has as many points as the original set!

1.5 Mathematical Induction

induction principle

Many a time it is desirable to make a mathematical statement that is true for all natural numbers. For example, we may want to establish a formula involving an integer parameter that will hold for all positive integers. One encounters this situation when, after experimenting with the first few positive integers, one recognizes a pattern and discovers a formula, and wants to make sure that the formula holds for all natural numbers. For this purpose, one uses **mathematical induction**. The essence of mathematical induction is stated as follows:

then down to $(3, 1)$, then diagonally up, and so on. Obviously the set is countable and it exhausts all rational numbers. In fact, the process double counts some of the entries.

Proposition 1.5.1 Suppose that there is associated with each natural number (positive integer) n a statement S_n . Then S_n is true for every positive integer provided the following two conditions hold:

1. S_1 is true.
2. If S_m is true for some given positive integer m , then S_{m+1} is also true.

Example 1.5.2 We illustrate the use of mathematical induction by proving the **binomial theorem**:

binomial theorem

$$\begin{aligned} (a+b)^m &= \sum_{k=0}^m \binom{m}{k} a^{m-k} b^k = \sum_{k=0}^m \frac{m!}{k!(m-k)!} a^{m-k} b^k \\ &= a^m + ma^{m-1}b + \frac{m(m-1)}{2!} a^{m-2}b^2 + \dots + mab^{m-1} + b^m, \end{aligned} \quad (1.1)$$

where we have used the notation

$$\binom{m}{k} \equiv \frac{m!}{k!(m-k)!}. \quad (1.2)$$

The mathematical statement S_m is Eq. (1.1). We note that S_1 is trivially true: $(a+b)^1 = a^1 + b^1$. Now we assume that S_m is true and show that S_{m+1} is also true. This means starting with Eq. (1.1) and showing that

$$(a+b)^{m+1} = \sum_{k=0}^{m+1} \binom{m+1}{k} a^{m+1-k} b^k.$$

Then the induction principle ensures that the statement (equation) holds for all positive integers. Multiply both sides of Eq. (1.1) by $a+b$ to obtain

$$(a+b)^{m+1} = \sum_{k=0}^m \binom{m}{k} a^{m-k+1} b^k + \sum_{k=0}^m \binom{m}{k} a^{m-k} b^{k+1}.$$

Now separate the $k=0$ term from the first sum and the $k=m$ term from the second sum:

$$\begin{aligned} (a+b)^{m+1} &= a^{m+1} + \sum_{k=1}^m \binom{m}{k} a^{m-k+1} b^k + \underbrace{\sum_{k=0}^{m-1} \binom{m}{k} a^{m-k} b^{k+1}}_{\text{let } k=j-1 \text{ in this sum}} + b^{m+1} \\ &= a^{m+1} + \sum_{k=1}^m \binom{m}{k} a^{m-k+1} b^k \\ &\quad + \sum_{j=1}^m \binom{m}{j-1} a^{m-j+1} b^j + b^{m+1}. \end{aligned}$$

The second sum in the last line involves j . Since this is a dummy index, we can substitute any symbol we please. The choice k is especially useful because then we can unite the two summations. This gives

$$(a + b)^{m+1} = a^{m+1} + \sum_{k=1}^m \left\{ \binom{m}{k} + \binom{m}{k-1} \right\} a^{m-k+1} b^k + b^{m+1}.$$

If we now use

$$\binom{m+1}{k} = \binom{m}{k} + \binom{m}{k-1},$$

which the reader can easily verify, we finally obtain

$$\begin{aligned} (a + b)^{m+1} &= a^{m+1} + \sum_{k=1}^m \binom{m+1}{k} a^{m-k+1} b^k + b^{m+1} \\ &= \sum_{k=0}^{m+1} \binom{m+1}{k} a^{m-k+1} b^k. \end{aligned}$$

This complete the proof.

Mathematical induction is also used in *defining* quantities involving integers. Such definitions are called **inductive definitions**. For example, inductive definition is used in defining powers: $a^1 = a$ and $a^m = a^{m-1}a$.

1.6 Problems

1.1 Show that the number of subsets of a set containing n elements is 2^n .

1.2 Let A , B , and C be sets in a universal set U . Show that

- $A \subset B$ and $B \subset C$ implies $A \subset C$.
- $A \subset B$ iff $A \cap B = A$ iff $A \cup B = B$.
- $A \subset B$ and $B \subset C$ implies $(A \cup B) \subset C$.
- $A \cup B = (A \sim B) \cup (A \cap B) \cup (B \sim A)$.

Hint: To show the equality of two sets, show that each set is a subset of the other.

1.3 For each $n \in \mathbb{N}$, let

$$I_n = \left\{ x \mid |x - 1| < n \text{ and } |x + 1| > \frac{1}{n} \right\}.$$

Find $\bigcup_n I_n$ and $\bigcap_n I_n$.

1.4 Show that $a' \in \llbracket a \rrbracket$ implies that $\llbracket a' \rrbracket = \llbracket a \rrbracket$.

1.5 Can you define a binary operation of “multiplication” on the set of vectors in space? What about vectors in the plane? In each case, write the components of the product in terms of the components of the two vectors.

1.6 Show that $(f \circ g)^{-1} = g^{-1} \circ f^{-1}$ when f and g are both bijections.

1.7 We show that the sequence $\{x_n\}_{n=1}^{\infty}$, where $x_n = \sum_{k=1}^n (-1)^{k+1}/k$, is Cauchy. Without loss of generality, assume that $n > m$ and $n - m$ is even (the case of odd $n - m$ can be handled similarly).

(a) Show that

$$x_n - x_m = (-1)^m \sum_{j=1}^{n-m} \frac{(-1)^j}{j+m}.$$

(b) Separate the even and odd parts of the sum and show that

$$x_n - x_m = (-1)^m \left\{ - \sum_{k=1}^{(n-m)/2} \frac{1}{2k-1+m} + \sum_{k=1}^{(n-m)/2} \frac{1}{2k+m} \right\}.$$

(c) Add the two sums to obtain a single sum, showing that

$$x_n - x_m = -(-1)^m \left\{ \sum_{k=1}^{(n-m)/2} \frac{1}{(2k+m)(2k+m-1)} \right\},$$

and that

$$\begin{aligned} |x_n - x_m| &\leq \sum_{k=1}^{(n-m)/2} \frac{1}{(2k+m-1)^2} \\ &= \frac{1}{(1+m)^2} + \sum_{k=2}^{(n-m)/2} \frac{1}{(2k+m-1)^2}. \end{aligned}$$

(d) Convince yourself that $\int_1^S f(x) dx \geq \sum_{k=2}^S f(k)$ for any continuous function $f(x)$, and apply it to part (c) to get

$$\begin{aligned} |x_n - x_m| &\leq \frac{1}{(1+m)^2} + \int_1^{(n-m)/2} \frac{1}{(2x+m-1)^2} dx \\ &= \frac{1}{n} + \frac{1}{(1+m)^2} - \frac{1}{2} \left(\frac{1}{n-1} - \frac{1}{m+1} \right). \end{aligned}$$

Each term on the last line goes to zero independently as m and n go to infinity.

1.8 Find a bijection $f : \mathbb{N} \rightarrow \mathbb{Z}$. Hint: Find an f which maps even integers onto the positive integers and odd integers onto the negative integers.

1.9 Take any two open intervals (a, b) and (c, d) , and show that there are as many points in the first as there are in the second, regardless of the size of the intervals. Hint: Find a (linear) algebraic relation between points of the two intervals.

Leibniz rule **1.10** Use mathematical induction to derive the **Leibniz rule** for differentiating a product:

$$\frac{d^n}{dx^n}(f \cdot g) = \sum_{k=0}^n \binom{n}{k} \frac{d^k f}{dx^k} \frac{d^{n-k} g}{dx^{n-k}}.$$

1.11 Use mathematical induction to derive the following results:

$$\sum_{k=0}^n r^k = \frac{r^{n+1} - 1}{r - 1}, \quad \sum_{k=0}^n k = \frac{n(n+1)}{2}.$$

Part I
Finite-Dimensional Vector Spaces

The familiar two- and three-dimensional vectors can easily be generalized to higher dimensions. Representing vectors by their components, one can conceive of vectors having N components. This is the most immediate generalization of vectors in the plane and in space, and such vectors are called N -dimensional **Cartesian** vectors. Cartesian vectors are limited in two respects: Their components are real, and their dimensionality is finite. Some applications in physics require the removal of one or both of these limitations. It is therefore convenient to study vectors stripped of any dimensionality or reality of components. Such properties become consequences of more fundamental definitions. Although we will be concentrating on finite-dimensional vector spaces in this part of the book, many of the concepts and examples introduced here apply to infinite-dimensional spaces as well.

Cartesian vectors

2.1 Vector Spaces

Let us begin with the definition of an abstract (complex) vector space.¹

Definition 2.1.1 A **vector space** \mathcal{V} over \mathbb{C} is a set of objects denoted by $|a\rangle$, $|b\rangle$, $|x\rangle$, and so on, called **vectors**, with the following properties:

vector space defined

1. To every pair of vectors $|a\rangle$ and $|b\rangle$ in \mathcal{V} there corresponds a vector $|a\rangle + |b\rangle$, also in \mathcal{V} , called the *sum* of $|a\rangle$ and $|b\rangle$, such that
 - (a) $|a\rangle + |b\rangle = |b\rangle + |a\rangle$,
 - (b) $|a\rangle + (|b\rangle + |c\rangle) = (|a\rangle + |b\rangle) + |c\rangle$,
 - (c) There exists a unique vector $|0\rangle \in \mathcal{V}$, called the **zero vector**, such that $|a\rangle + |0\rangle = |a\rangle$ for every vector $|a\rangle$,
 - (d) To every vector $|a\rangle \in \mathcal{V}$ there corresponds a unique vector $-|a\rangle \in \mathcal{V}$ such that $|a\rangle + (-|a\rangle) = |0\rangle$.

¹Keep in mind that \mathbb{C} is the set of complex numbers and \mathbb{R} the set of reals.

- scalars are numbers
2. To every complex number² α —also called a **scalar**—and every vector $|a\rangle$ there corresponds a vector $\alpha|a\rangle$ in \mathcal{V} such that
 - (a) $\alpha(\beta|a\rangle) = (\alpha\beta)|a\rangle$,
 - (b) $1|a\rangle = |a\rangle$.
 3. Multiplication involving vectors and scalars is distributive:
 - (a) $\alpha(|a\rangle + |b\rangle) = \alpha|a\rangle + \alpha|b\rangle$.
 - (b) $(\alpha + \beta)|a\rangle = \alpha|a\rangle + \beta|a\rangle$.

Dirac's bra and ket notation The **bra**, $\langle |$, and **ket**, $| \rangle$, notation for vectors, invented by Dirac, is very useful when dealing with complex vector spaces. However, it is somewhat clumsy for certain topics such as norm and metrics and will therefore be abandoned in those discussions.

complex versus real vector space The vector space defined above is also called a **complex vector space**. It is possible to replace \mathbb{C} with \mathbb{R} —the set of real numbers—in which case the resulting space will be called a **real vector space**.

concept of field summarized Real and complex numbers are prototypes of a mathematical structure called **field**. A field \mathbb{F} is a set of objects with two binary operations called addition and multiplication. Multiplication distributes over addition, and each operation has an identity. The identity for addition is denoted by 0 and is called *additive identity*. The identity for multiplication is denoted by 1 and is called *multiplicative identity*. Furthermore, every element $\alpha \in \mathbb{F}$ has an additive inverse $-\alpha$, and every element except the additive identity has a multiplicative inverse α^{-1} .

Example 2.1.2 (Some vector spaces)

1. \mathbb{R} is a vector space over the field of real numbers.
2. \mathbb{C} is a vector space over the field of real numbers.
3. \mathbb{C} is a vector space over the complex numbers.
4. Let $\mathcal{V} = \mathbb{R}$ and let the field of scalars be \mathbb{C} . This is *not* a vector space, because property 2 of Definition 2.1.1 is not satisfied: A complex number times a real number is not a real number and therefore does not belong to \mathcal{V} .
5. The set of “arrows” in the plane (or in space) forms a vector space over \mathbb{R} under the parallelogram law of addition of planar (or spatial) vectors.
6. Let $\mathcal{P}^c[t]$ be the set of all polynomials with complex coefficients in a variable t . Then $\mathcal{P}^c[t]$ is a vector space under the ordinary addition of polynomials and the multiplication of a polynomial by a complex number. In this case the zero vector is the zero polynomial.
7. For a given positive integer n , let $\mathcal{P}_n^c[t]$ be the set of all polynomials with complex coefficients of degree less than or equal to n . Again it is easy to verify that $\mathcal{P}_n^c[t]$ is a vector space under the usual addition

²Complex numbers, particularly when they are treated as *variables*, are usually denoted by z , and we shall adhere to this convention in Part III. However, in the discussion of vector spaces, we have found it more convenient to use lower case Greek letters to denote complex numbers as scalars.

of polynomials and their multiplication by complex scalars. In particular, the sum of two polynomials of degree less than or equal to n is also a polynomial of degree less than or equal to n , and multiplying a polynomial with complex coefficients by a complex number gives another polynomial of the same type. Here the zero polynomial is the zero vector.

8. The set $\mathcal{P}_n^r[t]$ of polynomials of degree less than or equal to n with real coefficients is a vector space over the reals, but it is *not* a vector space over the complex numbers.
9. Let \mathbb{C}^n consist of all complex n -tuples such as $|a\rangle = (\alpha_1, \alpha_2, \dots, \alpha_n)$ and $|b\rangle = (\beta_1, \beta_2, \dots, \beta_n)$. Let η be a complex number. Then we define

$$\begin{aligned}
 |a\rangle + |b\rangle &= (\alpha_1 + \beta_1, \alpha_2 + \beta_2, \dots, \alpha_n + \beta_n), \\
 \eta|a\rangle &= (\eta\alpha_1, \eta\alpha_2, \dots, \eta\alpha_n), \\
 |0\rangle &= (0, 0, \dots, 0), \\
 -|a\rangle &= (-\alpha_1, -\alpha_2, \dots, -\alpha_n).
 \end{aligned}$$

It is easy to verify that \mathbb{C}^n is a vector space over the complex numbers. It is called the *n -dimensional complex coordinate space*.

n -dimensional complex coordinate space

10. The set of all real n -tuples \mathbb{R}^n is a vector space over the real numbers under the operations similar to that of \mathbb{C}^n . It is called the *n -dimensional real coordinate space*, or *Cartesian n -space*. It is not a vector space over the complex numbers.
11. The set of all complex matrices with m rows and n columns $\mathcal{M}^{m \times n}$ is a vector space under the usual addition of matrices and multiplication by complex numbers. The zero vector is the $m \times n$ matrix with all entries equal to zero.
12. Let \mathbb{C}^∞ be the set of all complex sequences $|a\rangle = \{\alpha_i\}_{i=1}^\infty$ such that $\sum_{i=1}^\infty |\alpha_i|^2 < \infty$. One can show that with addition and scalar multiplication defined componentwise, \mathbb{C}^∞ is a vector space over the complex numbers.
13. The set of all complex-valued functions of a single real variable that are continuous in the real interval (a, b) is a vector space over the complex numbers.
14. The set $\mathcal{C}^n(a, b)$ of all real-valued functions of a single real variable defined on (a, b) that possess continuous derivatives of all orders up to n forms a vector space over the reals.
15. The set $\mathcal{C}^\infty(a, b)$ of all real-valued functions on (a, b) of a single real variable that possess derivatives of all orders forms a vector space over the reals.

n -dimensional real coordinate space, or Cartesian n -space

It is clear from the example above that a vector space depends as much on the nature of the vectors as on the nature of the scalars.

Definition 2.1.3 The vectors $|a_1\rangle, |a_2\rangle, \dots, |a_n\rangle$, are said to be **linearly independent** if for $\alpha_i \in \mathbb{C}$, the relation $\sum_{i=1}^n \alpha_i |a_i\rangle = 0$ implies $\alpha_i = 0$ for all i . The sum $\sum_{i=1}^n \alpha_i |a_i\rangle$ is called a **linear combination** of $\{|a_i\rangle\}_{i=1}^n$.

linear independence and linear combination of vectors defined

2.1.1 Subspaces

Given a vector space \mathcal{V} , one can consider a collection \mathcal{W} of vectors in \mathcal{V} , i.e., a subset of \mathcal{V} . Because \mathcal{W} is a subset, it contains vectors, but there is no guarantee that it contains the linear combination of those vectors. We now investigate conditions under which it does.

Definition 2.1.4 A **subspace** \mathcal{W} of a vector space \mathcal{V} is a nonempty subset of \mathcal{V} with the property that if $|a\rangle, |b\rangle \in \mathcal{W}$, then $\alpha|a\rangle + \beta|b\rangle$ also belongs to \mathcal{W} for all $\alpha, \beta \in \mathbb{C}$.

The intersection of two subspaces is also a subspace.

The reader may verify that a subspace is a vector space in its own right, and that *the intersection of two subspaces is also a subspace*.

Example 2.1.5 The following are subspaces of some of the vector spaces considered in Example 2.1.2. The reader is urged to verify the validity of each case.

- The “space” of real numbers is a subspace of \mathbb{C} over the reals.
- \mathbb{R} is *not* a subspace of \mathbb{C} over the complex numbers, because as explained in Example 2.1.2, \mathbb{R} cannot be a vector space over the complex numbers.
- The set of all vectors along a given line *going through the origin* is a subspace of arrows in the plane (or space) over \mathbb{R} .
- $\mathcal{P}_n^{\mathbb{C}}[t]$ is a subspace of $\mathcal{P}^{\mathbb{C}}[t]$.
- \mathbb{C}^{n-1} is a subspace of \mathbb{C}^n when \mathbb{C}^{n-1} is identified with all complex n -tuples with zero last entry. In general, \mathbb{C}^m is a subspace of \mathbb{C}^n for $m < n$ when \mathbb{C}^m is identified with all n -tuples whose last $n - m$ elements are zero.
- $\mathcal{M}^{r \times s}$ is a subspace of $\mathcal{M}^{m \times n}$ for $r \leq m$ and $s \leq n$. Here, we identify an $r \times s$ matrix with an $m \times n$ matrix whose last $m - r$ rows and $n - s$ columns are all zero.
- $\mathcal{P}_m^{\mathbb{C}}[t]$ is a subspace of $\mathcal{P}_n^{\mathbb{C}}[t]$ for $m < n$.
- $\mathcal{P}_m^{\mathbb{R}}[t]$ is a subspace of $\mathcal{P}_n^{\mathbb{R}}[t]$ for $m < n$. Note that both $\mathcal{P}_n^{\mathbb{R}}[t]$ and $\mathcal{P}_m^{\mathbb{R}}[t]$ are vector spaces over the reals only.
- \mathbb{R}^m is a subspace of \mathbb{R}^n for $m < n$. Therefore, \mathbb{R}^2 , the plane, is a subspace of \mathbb{R}^3 , the Euclidean space. Also, $\mathbb{R}^1 \equiv \mathbb{R}$ is a subspace of both the plane \mathbb{R}^2 and the Euclidean space \mathbb{R}^3 .
- Let \mathbf{a} be along the x -axis (a subspace of \mathbb{R}^2) and \mathbf{b} along the y -axis (also a subspace of \mathbb{R}^2). Then $\mathbf{a} + \mathbf{b}$ is neither along the x -axis nor along the y -axis. This shows that the union of two subspaces is not generally a subspace.

union of two subspaces is not a subspace

Theorem 2.1.6 If S is any nonempty set of vectors in a vector space \mathcal{V} , then the set \mathcal{W}_S of all linear combinations of vectors in S is a subspace of \mathcal{V} . We say that \mathcal{W}_S is the **span** of S , or that S spans \mathcal{W}_S , or that \mathcal{W}_S is spanned by S . \mathcal{W}_S is often denoted by $\text{Span}\{S\}$.

span of a subset of a vector space

The proof of Theorem 2.1.6 is left as Problem 2.6.

Definition 2.1.7 A **basis** of a vector space \mathcal{V} is a set B of linearly independent vectors that spans all of \mathcal{V} . A vector space that has a finite basis is called **finite-dimensional**; otherwise, it is **infinite-dimensional**. basis defined

The definition of the dimensionality of a vector space based on a single basis makes sense because of the following theorem which we state without proof (see [Axle 96, page 31]):

Theorem 2.1.8 All bases of a given finite-dimensional vector space have the same number of linearly independent vectors.

Definition 2.1.9 The cardinality of a basis of a vector space \mathcal{V} is called the **dimension** of \mathcal{V} and denoted by $\dim \mathcal{V}$. To emphasize its dependence on the scalars, $\dim_{\mathbb{C}} \mathcal{V}$ and $\dim_{\mathbb{R}} \mathcal{V}$ are also used. A vector space of dimension N is sometimes denoted by \mathcal{V}_N .

If $|a\rangle$ is a vector in an N -dimensional vector space \mathcal{V} and $B = \{|a_i\rangle\}_{i=1}^N$ a basis in that space, then by the definition of a basis, there exists a unique (see Problem 2.4) set of scalars $\{\alpha_1, \alpha_2, \dots, \alpha_n\}$ such that $|a\rangle = \sum_{i=1}^N \alpha_i |a_i\rangle$. The set $\{\alpha_i\}_{i=1}^N$ is called the **components** of $|a\rangle$ in the basis B . components of a vector
in a basis

Example 2.1.10 The following are bases for the vector spaces given in Example 2.1.2.

- The number 1 (or any nonzero real number) is a basis for \mathbb{R} , which is therefore one-dimensional.
- The numbers 1 and $i = \sqrt{-1}$ (or any pair of distinct nonzero complex numbers) are basis vectors for the vector space \mathbb{C} over \mathbb{R} . Thus, this space is two-dimensional.
- The number 1 (or any nonzero complex number) is a basis for \mathbb{C} over \mathbb{C} , and the space is one-dimensional. Note that although the vectors are the same as in the preceding item, changing the nature of the scalars changes the dimensionality of the space.
- The set $\{\hat{\mathbf{e}}_x, \hat{\mathbf{e}}_y, \hat{\mathbf{e}}_z\}$ of the unit vectors in the directions of the three axes forms a basis in space. The space is three-dimensional.
- A basis of $\mathcal{P}^c[t]$ can be formed by the monomials $1, t, t^2, \dots$. It is clear that this space is *infinite-dimensional*.
- A basis of \mathbb{C}^n is given by $\hat{\mathbf{e}}_1, \hat{\mathbf{e}}_2, \dots, \hat{\mathbf{e}}_n$, where $\hat{\mathbf{e}}_j$ is an n -tuple that has a 1 at the j th position and zeros everywhere else. This basis is called the **standard basis** of \mathbb{C}^n . Clearly, the space has n dimensions. standard basis of \mathbb{C}^n
- A basis of $\mathcal{M}^{m \times n}$ is given by $\mathbf{e}_{11}, \mathbf{e}_{12}, \dots, \mathbf{e}_{ij}, \dots, \mathbf{e}_{mn}$, where \mathbf{e}_{ij} is the $m \times n$ matrix with zeros everywhere except at the intersection of the i th row and j th column, where it has a one.
- A set consisting of the monomials $1, t, t^2, \dots, t^n$ forms a basis of $\mathcal{P}_n^c[t]$. Thus, this space is $(n + 1)$ -dimensional.
- The standard basis of \mathbb{C}^n is a basis of \mathbb{R}^n as well. It is also called the *standard basis* of \mathbb{R}^n . Thus, \mathbb{R}^n is n -dimensional.

- If we assume that $a < 0 < b$, then the set of monomials $1, x, x^2, \dots$ forms a basis for $\mathcal{C}^\infty(a, b)$, because, by Taylor's theorem, any function belonging to $\mathcal{C}^\infty(a, b)$ can be expanded in an infinite power series about $x = 0$. Thus, this space is infinite-dimensional.

Remark 2.1.1 Given a space \mathcal{V} with a basis $B = \{|a_i\rangle\}_{i=1}^n$, the span of any m vectors ($m < n$) of B is an m -dimensional subspace of \mathcal{V} .

2.1.2 Factor Space

Let \mathcal{W} be a subspace of the vector space \mathcal{V} , and define a relation on \mathcal{V} as follows. If $|a\rangle \in \mathcal{V}$ and $|b\rangle \in \mathcal{V}$, then we say that $|a\rangle$ is related to $|b\rangle$, and write $|a\rangle \bowtie |b\rangle$ if $|a\rangle - |b\rangle$ is in \mathcal{W} . It is easy to show that \bowtie is an equivalence relation. Denote the equivalence class of $|a\rangle$ by $\llbracket a \rrbracket$, and the factor set (or quotient set) $\{\llbracket a \rrbracket \mid |a\rangle \in \mathcal{V}\}$ by \mathcal{V}/\mathcal{W} . We turn the factor set into a factor space by defining the combined addition of vectors and their multiplication by scalars as follows:

$$\alpha \llbracket a \rrbracket + \beta \llbracket b \rrbracket = \llbracket \alpha a + \beta b \rrbracket \quad (2.1)$$

where $\llbracket \alpha a + \beta b \rrbracket$ is the equivalence class of $\alpha|a\rangle + \beta|b\rangle$. For this equation to make sense, it must be independent of the choice of the representatives of the classes. If $\llbracket a' \rrbracket = \llbracket a \rrbracket$ and $\llbracket b' \rrbracket = \llbracket b \rrbracket$, then is it true that $\llbracket \alpha a' + \beta b' \rrbracket = \llbracket \alpha a + \beta b \rrbracket$? For this to happen, we must have

$$(\alpha|a'\rangle + \beta|b'\rangle) - (\alpha|a\rangle + \beta|b\rangle) \in \mathcal{W}.$$

Now, since $|a'\rangle \in \llbracket a \rrbracket$, we must have $|a'\rangle = |a\rangle + |w_1\rangle$ for some $|w_1\rangle \in \mathcal{W}$. Similarly, $|b'\rangle = |b\rangle + |w_2\rangle$. Therefore,

$$(\alpha|a'\rangle + \beta|b'\rangle) - (\alpha|a\rangle + \beta|b\rangle) = \alpha|w_1\rangle + \beta|w_2\rangle$$

and the right-hand side is in \mathcal{W} because \mathcal{W} is a subspace.

Sometimes $\llbracket a \rrbracket$ is written as $|a\rangle + \mathcal{W}$. With this notation comes the equalities

$$|w\rangle + \mathcal{W} = \mathcal{W}, \quad \mathcal{W} + \mathcal{W} = \mathcal{W}, \quad \alpha\mathcal{W} = \mathcal{W}, \quad \alpha\mathcal{W} + \beta\mathcal{W} = \mathcal{W},$$

which abbreviate the obvious fact that the sum of two vectors in \mathcal{W} is a vector in \mathcal{W} , the product of a scalar and a vector in \mathcal{W} is a vector in \mathcal{W} , and the linear combination of two vectors in \mathcal{W} is a vector in \mathcal{W} .

How do we find a basis for \mathcal{V}/\mathcal{W} ? Let $\{|a_i\rangle\}$ be a basis for \mathcal{W} . Extend it to a basis $\{|a_i\rangle, |b_j\rangle\}$ for \mathcal{V} . Then, $\{\llbracket b_j \rrbracket\}$ form a basis for \mathcal{V}/\mathcal{W} . Indeed, let $\llbracket a \rrbracket \in \mathcal{V}/\mathcal{W}$. Then, since $|a\rangle$ is in \mathcal{V} , we have

$$\llbracket a \rrbracket \equiv |a\rangle + \mathcal{W} = \overbrace{\sum_i \alpha_i |a_i\rangle}^{\in \mathcal{W}} + \sum_j \beta_j |b_j\rangle + \mathcal{W}$$

$$= \sum_j \beta_j |b_j\rangle + \mathcal{W} \Rightarrow \llbracket a \rrbracket = \llbracket \sum_j \beta_j |b_j\rangle \rrbracket = \sum_j \beta_j \llbracket b_j \rrbracket.$$

Thus, $\{\llbracket b_j \rrbracket\}$ span \mathcal{V}/\mathcal{W} . To form a basis, they also have to be linearly independent. So, suppose that $\sum_j \beta_j \llbracket b_j \rrbracket = \llbracket 0 \rrbracket$. This means that

$$\sum_j \beta_j |b_j\rangle + \mathcal{W} = |0\rangle + \mathcal{W} = \mathcal{W} \Rightarrow \sum_j \beta_j |b_j\rangle \in \mathcal{W}.$$

So the last sum must be a linear combination of $\{|a_i\rangle\}$:

$$\sum_j \beta_j |b_j\rangle = \sum_i \alpha_i |a_i\rangle \quad \text{or} \quad \sum_j \beta_j |b_j\rangle - \sum_i \alpha_i |a_i\rangle = 0.$$

This is a zero linear combination of the basis vectors of \mathcal{V} . Therefore, all coefficients, including all β_j must be zero. One consequence of the argument above is (with obvious notation)

$$\dim(\mathcal{V}/\mathcal{W}) = \dim \mathcal{V} - \dim \mathcal{W} \tag{2.2}$$

2.1.3 Direct Sums

Sometimes it is possible, and convenient, to break up a vector space into special (disjoint) subspaces. For instance, the study of the motion of a particle in \mathbb{R}^3 under the influence of a central force field is facilitated by decomposing the motion into its projections onto the direction of angular momentum and onto a plane perpendicular to the angular momentum. This corresponds to decomposing a vector in space into a vector, say in the xy -plane and a vector along the z -axis. We can generalize this to any vector space, but first some notation: Let \mathcal{U} and \mathcal{W} be subspaces of a vector space \mathcal{V} . Denote by $\mathcal{U} + \mathcal{W}$ the collection of all vectors in \mathcal{V} that can be written as a sum of two vectors, one in \mathcal{U} and one in \mathcal{W} . It is easy to show that $\mathcal{U} + \mathcal{W}$ is a subspace of \mathcal{V} .

Sum of two subspaces defined

Example 2.1.11 Let \mathcal{U} be the xy -plane and \mathcal{W} the yz -plane. These are both subspaces of \mathbb{R}^3 , and so is $\mathcal{U} + \mathcal{W}$. In fact, $\mathcal{U} + \mathcal{W} = \mathbb{R}^3$, because given any vector (x, y, z) in \mathbb{R}^3 , we can write it as

$$(x, y, z) = \underbrace{\left(x, \frac{1}{2}y, 0\right)}_{\in \mathcal{U}} + \underbrace{\left(0, \frac{1}{2}y, z\right)}_{\in \mathcal{W}}.$$

This decomposition is not unique: We could also write $(x, y, z) = (x, \frac{1}{3}y, 0) + (0, \frac{2}{3}y, z)$, and a host of other relations.

Definition 2.1.12 Let \mathcal{U} and \mathcal{W} be subspaces of a vector space \mathcal{V} such that $\mathcal{V} = \mathcal{U} + \mathcal{W}$ and $\mathcal{U} \cap \mathcal{W} = \{0\}$. Then we say that \mathcal{V} is the **direct sum** of \mathcal{U} and \mathcal{W} and write $\mathcal{V} = \mathcal{U} \oplus \mathcal{W}$.

direct sum $\mathcal{U} \oplus \mathcal{W}$ defined

uniqueness of direct sum

Proposition 2.1.13 *Let \mathcal{U} and \mathcal{W} be subspaces of \mathcal{V} such that $\mathcal{V} = \mathcal{U} + \mathcal{W}$. Then $\mathcal{V} = \mathcal{U} \oplus \mathcal{W}$ if and only if any nonzero vector in \mathcal{V} can be written uniquely as a vector in \mathcal{U} plus a vector in \mathcal{W} .*

Proof Assume $\mathcal{V} = \mathcal{U} \oplus \mathcal{W}$, and let $|v\rangle \in \mathcal{V}$ be written as a sum of a vector in \mathcal{U} and a vector in \mathcal{W} in two different ways:

$$|v\rangle = |u\rangle + |w\rangle = |u'\rangle + |w'\rangle \Leftrightarrow |u\rangle - |u'\rangle = |w'\rangle - |w\rangle.$$

The LHS is in \mathcal{U} . Since it is equal to the RHS—which is in \mathcal{W} —it must be in \mathcal{W} as well. Therefore, the LHS must equal zero, as must the RHS. Thus, $|u\rangle = |u'\rangle$, $|w'\rangle = |w\rangle$, and there is only one way that $|v\rangle$ can be written as a sum of a vector in \mathcal{U} and a vector in \mathcal{W} .

Conversely, suppose that any vector in \mathcal{V} can be written uniquely as a vector in \mathcal{U} and a vector in \mathcal{W} . If $|a\rangle \in \mathcal{U}$ and also $|a\rangle \in \mathcal{W}$, then one can write

$$|a\rangle = \underbrace{\frac{1}{3}|a\rangle}_{\text{in } \mathcal{U}} + \underbrace{\frac{2}{3}|a\rangle}_{\text{in } \mathcal{W}} = \underbrace{\frac{1}{4}|a\rangle}_{\text{in } \mathcal{U}} + \underbrace{\frac{3}{4}|a\rangle}_{\text{in } \mathcal{W}}.$$

Hence $|a\rangle$ can be written in two different ways. By the uniqueness assumption $|a\rangle$ cannot be nonzero. Therefore, the only vector common to both \mathcal{U} and \mathcal{W} is the zero vector. This implies that $\mathcal{V} = \mathcal{U} \oplus \mathcal{W}$. \square

More generally, we have the following situation:

Definition 2.1.14 Let $\{\mathcal{U}_i\}_{i=1}^r$ be subspaces of \mathcal{V} such that

$$\mathcal{V} = \mathcal{U}_1 + \cdots + \mathcal{U}_r \quad \text{and} \quad \mathcal{U}_i \cap \mathcal{U}_j = \{0\} \quad \text{for all } i, j = 1, \dots, r.$$

Then we say that \mathcal{V} is the direct sum of $\{\mathcal{U}_i\}_{i=1}^r$ and write

$$\mathcal{V} = \mathcal{U}_1 \oplus \cdots \oplus \mathcal{U}_r = \bigoplus_{i=1}^r \mathcal{U}_i.$$

Let $\mathcal{W} = \mathcal{U}_1 \oplus \cdots \oplus \mathcal{U}_s$ be a direct sum of s subspaces (they need not span the entire \mathcal{V}). Write \mathcal{W} as $\mathcal{W} = \mathcal{U}_1 \oplus \mathcal{W}'$, with $\mathcal{W}' = \mathcal{U}_2 \oplus \cdots \oplus \mathcal{U}_s$. Let $\{|u_i\rangle\}_{i=1}^s$ be nonzero vectors with $|u_i\rangle \in \mathcal{U}_i$ and suppose that

$$\alpha_1|u_1\rangle + \alpha_2|u_2\rangle + \cdots + \alpha_s|u_s\rangle = |0\rangle, \quad (2.3)$$

or

$$\alpha_1|u_1\rangle + \alpha|w'\rangle = |0\rangle \Rightarrow \alpha_1|u_1\rangle = -\alpha|w'\rangle,$$

with $|w'\rangle \in \mathcal{W}'$. Since $\alpha_1|u_1\rangle \in \mathcal{U}_1$ from the left-hand side, and $\alpha_1|u_1\rangle \in \mathcal{W}'$ from the right-hand side, we must have $\alpha_1|u_1\rangle = |0\rangle$. Hence, $\alpha_1 = 0$ because $|u_1\rangle \neq |0\rangle$. Equation (2.3) now becomes

$$\alpha_2|u_2\rangle + \alpha_3|u_3\rangle + \cdots + \alpha_s|u_s\rangle = |0\rangle.$$

Write this as

$$\alpha_2|u_2\rangle + \beta|w''\rangle = |0\rangle \Rightarrow \alpha_2|u_2\rangle = -\beta|w''\rangle,$$

where $\mathcal{W}' = \mathcal{U}_2 \oplus \mathcal{W}''$ with $\mathcal{W}'' = \mathcal{U}_3 \oplus \cdots \oplus \mathcal{U}_s$ and $|w''\rangle \in \mathcal{W}''$. An argument similar to above shows that $\alpha_2 = 0$. Continuing in this way, we have

Proposition 2.1.15 *The vectors in different subspaces of Definition 2.1.14 are linearly independent.*

Proposition 2.1.16 *Let \mathcal{U} be a subspace of \mathcal{V} . Then there exist a subspace \mathcal{W} of \mathcal{V} such that $\mathcal{V} = \mathcal{U} \oplus \mathcal{W}$.*

Proof Let $\{|u_i\rangle\}_{i=1}^m$ be a basis of \mathcal{U} . Extend this basis to a basis $\{|u_i\rangle\}_{i=1}^N$ of \mathcal{V} . Then $\mathcal{W} = \text{Span}\{|u_j\rangle\}_{j=m+1}^N$. \square

Example 2.1.17 Let \mathcal{U} be the xy -plane and \mathcal{W} the z -axis. These are both subspaces of \mathbb{R}^3 , and so is $\mathcal{U} + \mathcal{W}$. Furthermore, it is clear that $\mathcal{U} + \mathcal{W} = \mathbb{R}^3$, because given any vector (x, y, z) in \mathbb{R}^3 , we can write it as

$$(x, y, z) = \underbrace{(x, y, 0)}_{\in \mathcal{U}} + \underbrace{(0, 0, z)}_{\in \mathcal{W}}.$$

This decomposition is obviously unique. Therefore, $\mathbb{R}^3 = \mathcal{U} \oplus \mathcal{W}$.

Proposition 2.1.18 *If $\mathcal{V} = \mathcal{U} \oplus \mathcal{W}$, then $\dim \mathcal{V} = \dim \mathcal{U} + \dim \mathcal{W}$.*

dimensions in a direct sum

Proof Let $\{|u_i\rangle\}_{i=1}^m$ be a basis for \mathcal{U} and $\{|w_i\rangle\}_{i=1}^k$ a basis for \mathcal{W} . Then it is easily verified that $\{|u_1\rangle, |u_2\rangle, \dots, |u_m\rangle, |w_1\rangle, |w_2\rangle, \dots, |w_k\rangle\}$ is a basis for \mathcal{V} . The details are left as an exercise. \square

Let \mathcal{U} and \mathcal{V} be any two vector spaces over \mathbb{R} or \mathbb{C} . Consider the Cartesian product $\mathcal{W} \equiv \mathcal{U} \times \mathcal{V}$ of their underlying set. Define a scalar multiplication and a sum on \mathcal{W} by

$$\begin{aligned} \alpha(|u\rangle, |v\rangle) &= (\alpha|u\rangle, \alpha|v\rangle) \\ (|u_1\rangle, |v_1\rangle) + (|u_2\rangle, |v_2\rangle) &= (|u_1\rangle + |u_2\rangle, |v_1\rangle + |v_2\rangle). \end{aligned} \tag{2.4}$$

With $|0\rangle_{\mathcal{W}} = (|0\rangle_{\mathcal{U}}, |0\rangle_{\mathcal{V}})$, \mathcal{W} becomes a vector space. Furthermore, if we identify \mathcal{U} and \mathcal{V} with vectors of the form $(|u\rangle, |0\rangle_{\mathcal{V}})$ and $(|0\rangle_{\mathcal{U}}, |v\rangle)$, respectively, then \mathcal{U} and \mathcal{V} become subspaces of \mathcal{W} . If a vector $|w\rangle \in \mathcal{W}$ belongs to both \mathcal{U} and \mathcal{V} , then it can be written as both $(|u\rangle, |0\rangle_{\mathcal{V}})$ and $(|0\rangle_{\mathcal{U}}, |v\rangle)$, i.e., $(|u\rangle, |0\rangle_{\mathcal{V}}) = (|0\rangle_{\mathcal{U}}, |v\rangle)$. But this can happen only if $|u\rangle = |0\rangle_{\mathcal{U}}$ and $|v\rangle = |0\rangle_{\mathcal{V}}$, or $|w\rangle = |0\rangle_{\mathcal{W}}$. Thus, the only common vector in \mathcal{U} and \mathcal{V} is the zero vector. Therefore,

Proposition 2.1.19 *Let \mathcal{U} and \mathcal{V} be any two vector spaces over \mathbb{R} or \mathbb{C} . Then their Cartesian product $\mathcal{W} \equiv \mathcal{U} \times \mathcal{V}$ together with the operations de-*

defined in Eq. (2.4) becomes a vector space. Furthermore, $\mathcal{W} = \mathcal{U} \oplus \mathcal{V}$ if \mathcal{U} and \mathcal{V} are identified with vectors of the form $(|u\rangle, |0\rangle_V)$ and $(|0\rangle_U, |v\rangle)$, respectively.

Let $\{|a_i\rangle\}_{i=1}^M$ be a basis of \mathcal{U} and $\{|b_j\rangle\}_{j=1}^N$ a basis of \mathcal{V} . Define the vectors $\{|c_k\rangle\}_{k=1}^{M+N}$ in $\mathcal{W} = \mathcal{U} \oplus \mathcal{V}$ by

$$\begin{aligned} |c_k\rangle &= (|a_k\rangle, |0\rangle_V) & \text{if } 1 \leq k \leq M \\ |c_k\rangle &= (|0\rangle_U, |b_{k-M}\rangle) & \text{if } M+1 \leq k \leq M+N. \end{aligned} \quad (2.5)$$

Then $\{|c_k\rangle\}_{k=1}^{M+N}$ are linearly independent. In fact,

$$\begin{aligned} \sum_{k=1}^{M+N} \gamma_k |c_k\rangle &= |0\rangle_W \quad \text{iff} \\ \sum_{k=1}^M \gamma_k (|a_k\rangle, |0\rangle_V) + \sum_{j=1}^N \gamma_{M+j} (|0\rangle_U, |b_j\rangle) &= (|0\rangle_U, |0\rangle_V), \end{aligned}$$

or

$$\left(\sum_{k=1}^M \gamma_k |a_k\rangle, |0\rangle_V \right) + \left(|0\rangle_U, \sum_{j=1}^N \gamma_{M+j} |b_j\rangle \right) = (|0\rangle_U, |0\rangle_V),$$

or

$$\left(\sum_{k=1}^M \gamma_k |a_k\rangle, \sum_{j=1}^N \gamma_{M+j} |b_j\rangle \right) = (|0\rangle_U, |0\rangle_V),$$

or

$$\sum_{k=1}^M \gamma_k |a_k\rangle = |0\rangle_U \quad \text{and} \quad \sum_{j=1}^N \gamma_{M+j} |b_j\rangle = |0\rangle_V.$$

Linear independence of $\{|a_i\rangle\}_{i=1}^M$ and $\{|b_j\rangle\}_{j=1}^N$ imply that $\gamma_k = 0$ for $1 \leq k \leq M+N$.

It is not hard to show that $\mathcal{W} = \text{Span}\{|c_k\rangle\}_{k=1}^{M+N}$. Hence, we have the following

Theorem 2.1.20 *Let $\{|a_i\rangle\}_{i=1}^M$ be a basis of \mathcal{U} and $\{|b_j\rangle\}_{j=1}^N$ a basis of \mathcal{V} . The set of vectors $\{|c_k\rangle\}_{k=1}^{M+N}$ defined by Eq. (2.5) form a basis of the direct sum $\mathcal{W} = \mathcal{U} \oplus \mathcal{V}$. In particular, \mathcal{W} has dimension $M+N$.*

2.1.4 Tensor Product of Vector Spaces

Direct sum is one way of constructing a new vector space out of two. There is another procedure. Let \mathcal{U} and \mathcal{V} be vector spaces. On their Cartesian prod-

uct, impose the scalar product and bilinearity conditions:

$$\begin{aligned}\alpha(|u\rangle, |v\rangle) &= (\alpha|u\rangle, |v\rangle) = (|u\rangle, \alpha|v\rangle) \\ (\alpha_1|u_1\rangle + \alpha_2|u_2\rangle, |v\rangle) &= \alpha_1(|u_1\rangle, |v\rangle) + \alpha_2(|u_2\rangle, |v\rangle) \\ (|u\rangle, \beta_1|v_1\rangle + \beta_2|v_2\rangle) &= \beta_1(|u\rangle, |v_1\rangle) + \beta_2(|u\rangle, |v_2\rangle).\end{aligned}\quad (2.6)$$

These properties turn $\mathcal{U} \times \mathcal{V}$ into a vector space called the **tensor product** of \mathcal{U} and \mathcal{V} and denoted by $\mathcal{U} \otimes \mathcal{V}$.³ The vectors in the tensor product space are denoted by $|u\rangle \otimes |v\rangle$, (or occasionally by $|uv\rangle$). If $\{|a_i\rangle\}_{i=1}^M$ and $\{|b_j\rangle\}_{j=1}^N$ are bases in \mathcal{U} and \mathcal{V} , respectively, and

$$|u\rangle = \sum_{i=1}^M \alpha_i |a_i\rangle \quad \text{and} \quad |v\rangle = \sum_{j=1}^N \beta_j |b_j\rangle,$$

then Eq. (2.6) yields

$$|u\rangle \otimes |v\rangle = \left(\sum_{i=1}^M \alpha_i |a_i\rangle \right) \otimes \left(\sum_{j=1}^N \beta_j |b_j\rangle \right) = \sum_{i=1}^M \sum_{j=1}^N \alpha_i \beta_j |a_i\rangle \otimes |b_j\rangle.$$

Therefore, $\{|a_i\rangle \otimes |b_j\rangle\}$ is a basis of $\mathcal{U} \otimes \mathcal{V}$ and $\dim(\mathcal{U} \otimes \mathcal{V}) = \dim \mathcal{U} \dim \mathcal{V}$.

From (2.6), we have

$$|0\rangle_U \otimes |v\rangle = (|u\rangle - |u\rangle) \otimes |v\rangle = |u\rangle \otimes |v\rangle - |u\rangle \otimes |v\rangle = |0\rangle_{U \otimes V}$$

Similarly, $|u\rangle \otimes |0\rangle_V = |0\rangle_{U \otimes V}$.

2.2 Inner Product

A vector space, as given by Definition 2.1.1, is too general and structureless to be of much physical interest. One useful structure introduced on a vector space is a scalar product. Recall that the scalar (dot) product of vectors in the plane or in space is a rule that associates with two vectors \mathbf{a} and \mathbf{b} , a real number. This association, denoted symbolically by $g : \mathcal{V} \times \mathcal{V} \rightarrow \mathbb{R}$, with $g(\mathbf{a}, \mathbf{b}) = \mathbf{a} \cdot \mathbf{b}$, is symmetric: $g(\mathbf{a}, \mathbf{b}) = g(\mathbf{b}, \mathbf{a})$, is linear in the first (and by symmetry, in the second) factor:⁴

$$g(\alpha\mathbf{a} + \beta\mathbf{b}, \mathbf{c}) = \alpha g(\mathbf{a}, \mathbf{c}) + \beta g(\mathbf{b}, \mathbf{c}) \quad \text{or} \quad (\alpha\mathbf{a} + \beta\mathbf{b}) \cdot \mathbf{c} = \alpha\mathbf{a} \cdot \mathbf{c} + \beta\mathbf{b} \cdot \mathbf{c},$$

gives the “length” of a vector: $|\mathbf{a}|^2 = g(\mathbf{a}, \mathbf{a}) = \mathbf{a} \cdot \mathbf{a} \geq 0$, and ensures that the only vector with zero length⁵ is the zero vector: $g(\mathbf{a}, \mathbf{a}) = 0$ if and only if $\mathbf{a} = \mathbf{0}$.

³A detailed discussion of tensor products and tensors in general is given in Chap. 26.

⁴A function that is linear in both of its arguments is called a **bilinear** function.

⁵In our present discussion, we are avoiding situations in which a nonzero vector can have zero “length”. Such occasions arise in relativity, and we shall discuss them in Part VIII.

We want to generalize these properties to abstract vector spaces for which the scalars are complex numbers. A verbatim generalization of the foregoing properties, however, leads to a contradiction. Using the linearity in both arguments and a nonzero $|a\rangle$, we obtain

$$g(i|a\rangle, i|a\rangle) = i^2 g(|a\rangle, |a\rangle) = -g(|a\rangle, |a\rangle). \quad (2.7)$$

Either the right-hand side (RHS) or left-hand side (LHS) of this equation must be negative! But this is inconsistent with the positivity of the “length” of a vector, which requires $g(|a\rangle, |a\rangle)$ to be positive for *all* nonzero vectors, including $i|a\rangle$. The source of the problem is the linearity in *both* arguments. If we can change this property in such a way that one of the i 's in Eq. (2.7) comes out complex-conjugated, the problem may go away. This requires linearity in one argument and complex-conjugate linearity in the other. Which argument is to be complex-conjugate linear is a matter of convention. We choose the first argument to be so.⁶ We thus have

$$g(\alpha|a\rangle + \beta|b\rangle, |c\rangle) = \alpha^* g(|a\rangle, |c\rangle) + \beta^* g(|b\rangle, |c\rangle),$$

where α^* denotes the complex conjugate. Consistency then requires us to change the symmetry property as well. In fact, we must demand that $g(|a\rangle, |b\rangle) = (g(|b\rangle, |a\rangle))^*$, from which the *reality* of $g(|a\rangle, |a\rangle)$ —a necessary condition for its positivity—follows immediately.

The question of the existence of an inner product on a vector space is a deep problem in higher analysis. Generally, if an inner product exists, there may be many ways to introduce one on a vector space. However, as we shall see in Sect. 2.2.4, a *finite-dimensional* vector space always has an inner product and this inner product is unique.⁷ So, for all practical purposes we can speak of *the* inner product on a finite-dimensional vector space, and as with the two- and three-dimensional cases, we can omit the letter g and use a notation that involves only the vectors. There are several such notations in use, but the one that will be employed in this book is the *Dirac bra(c)ket notation*, whereby $g(|a\rangle, |b\rangle)$ is denoted by $\langle a|b\rangle$. Using this notation, we have

Dirac “bra,” $\langle |$, and
“ket” $| \rangle$, notation is used
for inner products.

Definition 2.2.1 The **inner product** of two vectors, $|a\rangle$ and $|b\rangle$, in a vector space \mathcal{V} is a complex number, $\langle a|b\rangle \in \mathbb{C}$, such that

1. $\langle a|b\rangle = \langle b|a\rangle^*$
2. $\langle a|(\beta|b\rangle + \gamma|c\rangle) = \beta\langle a|b\rangle + \gamma\langle a|c\rangle$
3. $\langle a|a\rangle \geq 0$, and $\langle a|a\rangle = 0$ if and only if $|a\rangle = |0\rangle$.

positive definite, or
Euclidean inner product

The last relation is called the **positive definite** property of the inner prod-

⁶In some books, particularly in the mathematical literature, the second argument is chosen to be conjugate linear.

⁷This uniqueness holds up to a certain equivalence of inner products that we shall not get into here.

uct.⁸ A positive definite real inner product is also called a **Euclidean** inner product, otherwise it is called **pseudo-Euclidean**.

Note that linearity in the first argument is absent in the definition above, because, as explained earlier, it would be inconsistent with the first property, which expresses the “symmetry” of the inner product. The extra operation of complex conjugation renders the true linearity in the first argument impossible. Because of this complex conjugation, the inner product on a complex vector space is not truly bilinear; it is commonly called **sesquilinear** or **hermitian**.

sesquilinear or hermitian
inner product

A shorthand notation will be useful when dealing with the inner product of a linear combination of vectors.

Box 2.2.2 We write the LHS of the second equation in the definition above as $\langle a|\beta b + \gamma c\rangle$.

This has the advantage of treating a linear combination as a single vector. The second property then states that if the complex scalars happen to be in a *ket*, they “split out” unaffected:

$$\langle a|\beta b + \gamma c\rangle = \beta \langle a|b\rangle + \gamma \langle a|c\rangle. \quad (2.8)$$

On the other hand, if the complex scalars happen to be in the first factor (the bra), then they should be conjugated when they are “split out”:

$$\langle \beta b + \gamma c|a\rangle = \beta^* \langle b|a\rangle + \gamma^* \langle c|a\rangle. \quad (2.9)$$

A vector space \mathcal{V} on which an inner product is defined is called an **inner product space**. As mentioned above, a finite-dimensional vector space can always be turned into an inner product space.

Example 2.2.3 In this example, we introduce some of the most common inner products. The reader is urged to verify that in all cases, we indeed have an inner product.

- Let $|a\rangle, |b\rangle \in \mathbb{C}^n$, with $|a\rangle = (\alpha_1, \alpha_2, \dots, \alpha_n)$ and $|b\rangle = (\beta_1, \beta_2, \dots, \beta_n)$, and define an inner product on \mathbb{C}^n as natural inner product
for \mathbb{C}^n

$$\langle a|b\rangle \equiv \alpha_1^* \beta_1 + \alpha_2^* \beta_2 + \dots + \alpha_n^* \beta_n = \sum_{i=1}^n \alpha_i^* \beta_i.$$

That this product satisfies all the required properties of an inner product is easily checked. For example, if $|b\rangle = |a\rangle$, we obtain $\langle a|a\rangle = |\alpha_1|^2 + |\alpha_2|^2 + \dots + |\alpha_n|^2$, which is clearly nonnegative.

⁸The positive definiteness must be relaxed in the space-time of relativity theory, in which nonzero vectors can have zero “length”.

- Similarly, for $|a\rangle, |b\rangle \in \mathbb{R}^n$ the same definition (without the complex conjugation) satisfies all the properties of an inner product.
 - For $|a\rangle, |b\rangle \in \mathbb{C}^\infty$ the natural inner product is defined as $\langle a|b\rangle = \sum_{i=1}^\infty \alpha_i^* \beta_i$. The question of the convergence of this infinite sum is the subject of Problem 2.18.
- weight function of an inner product defined in terms of integrals
- Let $x(t), y(t) \in \mathcal{P}^c[t]$, the space of all polynomials in t with complex coefficients. Define

$$\langle x|y\rangle \equiv \int_a^b w(t)x^*(t)y(t) dt, \quad (2.10)$$

where a and b are real numbers—or infinity—for which the integral exists, and $w(t)$, called the **weight function**, is a real-valued, continuous function that is *always strictly positive* in the interval (a, b) . Then Eq. (2.10) defines an inner product. Depending on the weight function $w(t)$, there can be many different inner products defined on the infinite-dimensional space $\mathcal{P}^c[t]$.

- Let $f, g \in \mathbb{C}(a, b)$ and define their inner product by
- natural inner product for complex functions

$$\langle f|g\rangle \equiv \int_a^b w(x)f^*(x)g(x) dx.$$

It is easily shown that $\langle f|g\rangle$ satisfies all the requirements of the inner product if, as in the previous case, the weight function $w(x)$ is always positive in the interval (a, b) . This is called the *standard inner product* on $\mathbb{C}(a, b)$.

2.2.1 Orthogonality

The vectors of analytic geometry and calculus are often expressed in terms of unit vectors along the axes, i.e., vectors that are of unit length and perpendicular to one another. Such vectors are also important in abstract inner product spaces.

orthogonality defined

orthonormal basis

Definition 2.2.4 Vectors $|a\rangle, |b\rangle \in \mathcal{V}$ are **orthogonal** if $\langle a|b\rangle = 0$. A **normal vector**, or *normalized vector*, $|e\rangle$ is one for which $\langle e|e\rangle = 1$. A basis $B = \{|e_i\rangle\}_{i=1}^N$ in an N -dimensional vector space \mathcal{V} is an **orthonormal basis** if

$$\langle e_i|e_j\rangle = \delta_{ij} \equiv \begin{cases} 1 & \text{if } i = j, \\ 0 & \text{if } i \neq j, \end{cases} \quad (2.11)$$

Kronecker delta

where δ_{ij} , defined by the last equality, is called the **Kronecker delta**.

Example 2.2.5 Let \mathcal{U} and \mathcal{V} be inner product vector spaces. Let $\mathcal{W} = \mathcal{U} \oplus \mathcal{V}$. Then an inner product can be defined on \mathcal{W} in terms of those on \mathcal{U} and \mathcal{V} . In fact, it can be easily shown that if $|w_i\rangle = (|u_i\rangle, |v_i\rangle)$, $i = 1, 2$, then

$$\langle w_1|w_2\rangle = \langle u_1|u_2\rangle + \langle v_1|v_2\rangle \quad (2.12)$$

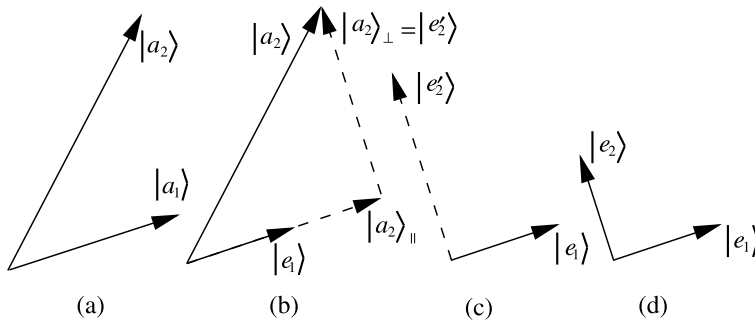

Fig. 2.1 The essence of the Gram–Schmidt process is neatly illustrated by the process in two dimensions. This figure, depicts the stages of the construction of two orthonormal vectors

defines an inner product on \mathcal{W} . Moreover, with the identification

$$\mathcal{U} = \{(|u\rangle, |0\rangle_V) \mid |u\rangle \in \mathcal{U}\} \quad \text{and} \quad \mathcal{V} = \{(|0\rangle_U, |v\rangle) \mid |v\rangle \in \mathcal{V}\},$$

any vector in \mathcal{U} is orthogonal to any vector in \mathcal{V} .

Example 2.2.6 Here are examples of orthonormal bases:

- The standard basis of \mathbb{R}^n (or \mathbb{C}^n)

$$|e_1\rangle = (1, 0, \dots, 0), \quad |e_2\rangle = (0, 1, \dots, 0), \quad \dots, \quad |e_n\rangle = (0, 0, \dots, 1)$$

is orthonormal under the usual inner product of those spaces.

- Let $|e_k\rangle = e^{ikx}/\sqrt{2\pi}$ be functions in $\mathbb{C}(0, 2\pi)$ with $w(x) = 1$. Then

$$\langle e_k | e_k \rangle = \frac{1}{2\pi} \int_0^{2\pi} e^{-ikx} e^{ikx} dx = 1,$$

and for $l \neq k$,

$$\langle e_l | e_k \rangle = \frac{1}{2\pi} \int_0^{2\pi} e^{-ilx} e^{ikx} dx = \frac{1}{2\pi} \int_0^{2\pi} e^{i(k-l)x} dx = 0.$$

Thus, $\langle e_l | e_k \rangle = \delta_{lk}$.

2.2.2 The Gram-Schmidt Process

It is always possible to convert—by taking appropriate linear combinations—any basis in \mathcal{V} into an orthonormal basis. A process by which this may be accomplished is called **Gram–Schmidt orthonormalization**. Consider a basis $B = \{|a_i\rangle\}_{i=1}^N$. We intend to take linear combinations of $|a_i\rangle$ in such a way that the resulting vectors are orthonormal. First, we let $|e_1\rangle = |a_1\rangle/\sqrt{\langle a_1 | a_1 \rangle}$ and note that $\langle e_1 | e_1 \rangle = 1$. If we subtract from $|a_2\rangle$ its projection along $|e_1\rangle$, we obtain a vector that is orthogonal to $|e_1\rangle$ (see Fig. 2.1).

The Gram–Schmidt process explained

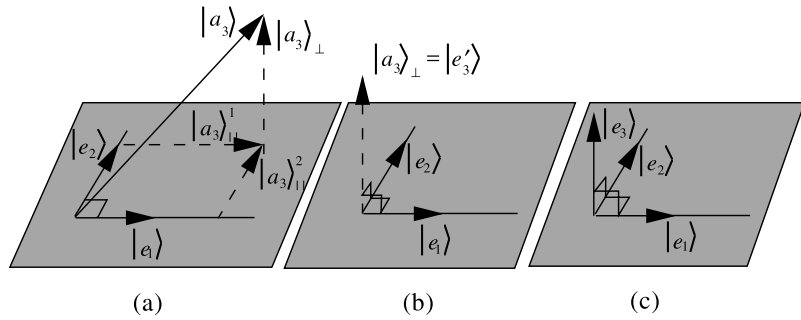

Fig. 2.2 Once the orthonormal vectors in the plane of two vectors are obtained, the third orthonormal vector is easily constructed

Calling the resulting vector $|e'_2\rangle$, we have $|e'_2\rangle = |a_2\rangle - \langle e_1|a_2\rangle|e_1\rangle$, which can be written more symmetrically as $|e'_2\rangle = |a_2\rangle - |e_1\rangle\langle e_1|a_2\rangle$. Clearly, this vector is orthogonal to $|e_1\rangle$. In order to normalize $|e'_2\rangle$, we divide it by $\sqrt{\langle e'_2|e'_2\rangle}$. Then $|e_2\rangle = |e'_2\rangle/\sqrt{\langle e'_2|e'_2\rangle}$ will be a normal vector orthogonal to $|e_1\rangle$. Subtracting from $|a_3\rangle$ its projections along the first and second unit vectors obtained so far will give the vector

$$|e'_3\rangle = |a_3\rangle - |e_1\rangle\langle e_1|a_3\rangle - |e_2\rangle\langle e_2|a_3\rangle = |a_3\rangle - \sum_{i=1}^2 |e_i\rangle\langle e_i|a_3\rangle,$$

which is orthogonal to both $|e_1\rangle$ and $|e_2\rangle$ (see Fig. 2.2):

$$\langle e_1|e'_3\rangle = \langle e_1|a_3\rangle - \overbrace{\langle e_1|e_1\rangle}^{=1}\langle e_1|a_3\rangle - \overbrace{\langle e_1|e_2\rangle}^{=0}\langle e_2|a_3\rangle = 0.$$

Similarly, $\langle e_2|e'_3\rangle = 0$.

Historical Notes

Erhard Schmidt (1876–1959) obtained his doctorate under the supervision of David Hilbert. His main interest was in integral equations and Hilbert spaces. He is the “Schmidt” of the **Gram–Schmidt orthogonalization process**, which takes a basis of a space and constructs an orthonormal one from it. (Laplace had presented a special case of this process long before Gram or Schmidt.)

In 1908 Schmidt worked on infinitely many equations in infinitely many unknowns, introducing various geometric notations and terms that are still in use for describing spaces of functions. Schmidt’s ideas were to lead to the geometry of Hilbert spaces. This was motivated by the study of integral equations (see Chap. 18) and an attempt at their abstraction.

Earlier, Hilbert regarded a function as given by its Fourier coefficients. These satisfy the condition that $\sum_{k=1}^{\infty} a_k^2$ is finite. He introduced sequences of real numbers $\{x_n\}$ such that $\sum_{n=1}^{\infty} x_n^2$ is finite. Riesz and Fischer showed that there is a one-to-one correspondence between square-integrable functions and square-summable sequences of their Fourier coefficients. In 1907 Schmidt and Fréchet showed that a consistent theory could be obtained if the square-summable sequences were regarded as the coordinates of points in an infinite-dimensional space that is a generalization of n -dimensional Euclidean space. Thus *functions can be regarded as points of a space*, now called a **Hilbert space**.



Erhard Schmidt
1876–1959

In general, if we have calculated m orthonormal vectors $|e_1\rangle, \dots, |e_m\rangle$, with $m < N$, then we can find the next one using the following relations:

$$\begin{aligned} |e'_{m+1}\rangle &= |a_{m+1}\rangle - \sum_{i=1}^m |e_i\rangle \langle e_i | a_{m+1}\rangle, \\ |e_{m+1}\rangle &= \frac{|e'_{m+1}\rangle}{\sqrt{\langle e'_{m+1} | e'_{m+1}\rangle}}. \end{aligned} \quad (2.13)$$

Even though we have been discussing finite-dimensional vector spaces, the process of Eq. (2.13) can continue for infinite-dimensions as well. The reader is asked to pay attention to the fact that, at each stage of the Gram-Schmidt process, one is taking linear combinations of the original vectors.

2.2.3 The Schwarz Inequality

Let us now consider an important inequality that is valid in both finite and infinite dimensions and whose restriction to two and three dimensions is equivalent to the fact that the cosine of the angle between two vectors is always less than one.

Theorem 2.2.7 *For any pair of vectors $|a\rangle, |b\rangle$ in an inner product space \mathcal{V} , the **Schwarz inequality** holds: $\langle a|a\rangle \langle b|b\rangle \geq |\langle a|b\rangle|^2$. Equality holds when $|a\rangle$ is proportional to $|b\rangle$.* Schwarz inequality

Proof Let $|c\rangle = |b\rangle - (\langle a|b\rangle / \langle a|a\rangle) |a\rangle$, and note that $\langle a|c\rangle = 0$. Write $|b\rangle = (\langle a|b\rangle / \langle a|a\rangle) |a\rangle + |c\rangle$ and take the inner product of $|b\rangle$ with itself:

$$\langle b|b\rangle = \left| \frac{\langle a|b\rangle}{\langle a|a\rangle} \right|^2 \langle a|a\rangle + \langle c|c\rangle = \frac{|\langle a|b\rangle|^2}{\langle a|a\rangle} + \langle c|c\rangle.$$

Since $\langle c|c\rangle \geq 0$, we have

$$\langle b|b\rangle \geq \frac{|\langle a|b\rangle|^2}{\langle a|a\rangle} \Rightarrow \langle a|a\rangle \langle b|b\rangle \geq |\langle a|b\rangle|^2.$$

Equality holds iff $\langle c|c\rangle = 0$, i.e., iff $|c\rangle = 0$. From the definition of $|c\rangle$, we conclude that for the equality to hold, $|a\rangle$ and $|b\rangle$ must be proportional. \square

Notice the power of abstraction: We have derived the Schwarz inequality solely from the basic assumptions of inner product spaces independent of the specific nature of the inner product. Therefore, we do not have to prove the Schwarz inequality every time we encounter a new inner product space.

Historical Notes

Karl Herman Amandus Schwarz (1843–1921) the son of an architect, was born in what is now Sobiecín, Poland. After gymnasium, Schwarz studied chemistry in Berlin for a time before switching to mathematics, receiving his doctorate in 1864. He was greatly influenced by the reigning mathematicians in Germany at the time, especially Kummer



Karl Herman Amandus Schwarz 1843–1921

and Weierstrass. The lecture notes that Schwarz took while attending Weierstrass’s lectures on the integral calculus still exist. Schwarz received an initial appointment at Halle and later appointments in Zurich and Göttingen before being named as Weierstrass’s successor at Berlin in 1892. These later years, filled with students and lectures, were not Schwarz’s most productive, but his early papers assure his place in mathematics history. Schwarz’s favorite tool was geometry, which he soon turned to the study of analysis. He conclusively proved some of Riemann’s results that had been previously (and justifiably) challenged. The primary result in question was the assertion that every simply connected region in the plane could be conformally mapped onto a circular area. From this effort came several well-known results now associated with Schwarz’s name, including the principle of reflection and Schwarz’s lemma. He also worked on surfaces of minimal area, the branch of geometry beloved by all who dabble with soap bubbles.

Schwarz’s most important work, for the occasion of Weierstrass’s seventieth birthday, again dealt with minimal area, specifically whether a minimal surface yields a minimal area. Along the way, Schwarz demonstrated second variation in a multiple integral, constructed a function using successive approximation, and demonstrated the existence of a “least” eigenvalue for certain differential equations. This work also contained the most famous inequality in mathematics, which bears his name.

Schwarz’s success obviously stemmed from a matching of his aptitude and training to the mathematical problems of the day. One of his traits, however, could be viewed as either positive or negative—his habit of treating all problems, whether trivial or monumental, with the same level of attention to detail. This might also at least partly explain the decline in productivity in Schwarz’s later years.

Schwarz had interests outside mathematics, although his marriage was a mathematical one, since he married Kummer’s daughter. Outside mathematics he was the captain of the local voluntary fire brigade, and he assisted the stationmaster at the local railway station by closing the doors of the trains!

2.2.4 Length of a Vector

In dealing with objects such as directed line segments in the plane or in space, the intuitive idea of the length of a vector is used to define the dot product. However, sometimes it is more convenient to introduce the inner product first and then define the length, as we shall do now.

norm of a vector defined

Definition 2.2.8 The **norm**, or *length*, of a vector $|a\rangle$ in an inner product space is denoted by $\|a\|$ and defined as $\|a\| \equiv \sqrt{\langle a|a\rangle}$. We use the notation $\|\alpha a + \beta b\|$ for the norm of the vector $\alpha|a\rangle + \beta|b\rangle$.

One can easily show that the norm has the following properties:

1. The norm of the zero vector is zero: $\|0\| = 0$.
2. $\|a\| \geq 0$, and $\|a\| = 0$ if and only if $|a\rangle = |0\rangle$.
3. $\|\alpha a\| = |\alpha| \|a\|$ for any⁹ complex α .
4. $\|a + b\| \leq \|a\| + \|b\|$. This property is called the **triangle inequality**.

triangle inequality

normed linear space

Any function on a vector space satisfying the four properties above is called a **norm**, and the vector space on which a norm is defined is called a **normed linear space**. One does not need an inner product to have a norm.

natural distance in a normed linear space

One can introduce the idea of the “distance” between two vectors in a normed linear space. The distance between $|a\rangle$ and $|b\rangle$ —denoted by $d(a, b)$ —is simply the norm of their difference: $d(a, b) \equiv \|a - b\|$. It can

⁹The first property follows from this by letting $\alpha = 0$.

be readily shown that this has all the properties one expects of the distance (or metric) function introduced in Chap. 1. However, one does not need a normed space to define distance. For example, as explained in Chap. 1, one can define the distance between two points on the surface of a sphere, but the addition of two points on a sphere—a necessary operation for vector space structure—is not defined. Thus the points on a sphere form a metric space, but not a vector space.

Inner product spaces are automatically normed spaces, but the converse is not, in general, true: There are normed spaces, i.e., spaces satisfying properties 1–4 above that cannot be promoted to inner product spaces. However, if the norm satisfies the **parallelogram law**,

$$\|a + b\|^2 + \|a - b\|^2 = 2\|a\|^2 + 2\|b\|^2, \quad (2.14)$$

then one can define

$$\langle a|b \rangle \equiv \frac{1}{4} \{ \|a + b\|^2 - \|a - b\|^2 - i(\|a + ib\|^2 - \|a - ib\|^2) \} \quad (2.15)$$

and show that it is indeed an inner product. In fact, we have (see [Frie 82, pp. 203–204] for a proof) the following theorem.

Theorem 2.2.9 *A normed linear space is an inner product space if and only if the norm satisfies the parallelogram law.*

Now consider any N -dimensional vector space \mathcal{V} . Choose a basis $\{|a_i\rangle\}_{i=1}^N$ in \mathcal{V} , and for any vector $|a\rangle$ whose components are $\{\alpha_i\}_{i=1}^N$ in this basis, define

$$\|a\|^2 \equiv \sum_{i=1}^N |\alpha_i|^2.$$

The reader may check that this defines a norm, and that the norm satisfies the parallelogram law. From Theorem 2.2.9 we have the following:

Theorem 2.2.10 *Every finite-dimensional vector space can be turned into an inner product space.*

Example 2.2.11 Let the space be \mathbb{C}^n . The natural inner product of \mathbb{C}^n gives rise to a norm, which, for the vector $|a\rangle = (\alpha_1, \alpha_2, \dots, \alpha_n)$ is

$$\|a\| = \sqrt{\langle a|a \rangle} = \sqrt{\sum_{i=1}^n |\alpha_i|^2}.$$

This norm yields the following distance between $|a\rangle$ and $|b\rangle = (\beta_1, \beta_2, \dots, \beta_n)$:

$$d(a, b) = \|a - b\| = \sqrt{\langle a - b|a - b \rangle} = \sqrt{\sum_{i=1}^n |\alpha_i - \beta_i|^2}.$$

\mathbb{C}^n has many different distance functions

One can define other norms, such as $\|a\|_1 \equiv \sum_{i=1}^n |\alpha_i|$, which has all the required properties of a norm, and leads to the distance

$$d_1(a, b) = \|a - b\|_1 = \sum_{i=1}^n |\alpha_i - \beta_i|.$$

Another norm defined on \mathbb{C}^n is given by

$$\|a\|_p \equiv \left(\sum_{i=1}^n |\alpha_i|^p \right)^{1/p},$$

where p is a positive integer. It is proved in higher mathematical analysis that $\|\cdot\|_p$ has all the properties of a norm. (The nontrivial part of the proof is to verify the triangle inequality.) The associated distance is

$$d_p(a, b) = \|a - b\|_p = \left(\sum_{i=1}^n |\alpha_i - \beta_i|^p \right)^{1/p}.$$

The other two norms introduced above are special cases, for $p = 2$ and $p = 1$.

2.3 Linear Maps

We have made progress in enriching vector spaces with structures such as norms and inner products. However, this enrichment, although important, will be of little value if it is imprisoned in a single vector space. We would like to give vector space properties freedom of movement, so they can go from one space to another. The vehicle that carries these properties is a linear map or linear transformation which is the subject of this section. First it is instructive to review the concept of a map (discussed in Chap. 1) by considering some examples relevant to the present discussion.

Example 2.3.1 The following are a few familiar examples of mappings.

1. Let $f : \mathbb{R} \rightarrow \mathbb{R}$ be given by $f(x) = x^2$.
2. Let $g : \mathbb{R}^2 \rightarrow \mathbb{R}$ be given by $g(x, y) = x^2 + y^2 - 4$.
3. Let $F : \mathbb{R}^2 \rightarrow \mathbb{C}$ be given by $F(x, y) = U(x, y) + iV(x, y)$, where $U : \mathbb{R}^2 \rightarrow \mathbb{R}$ and $V : \mathbb{R}^2 \rightarrow \mathbb{R}$.
4. Let $T : \mathbb{R} \rightarrow \mathbb{R}^2$ be given by $T(t) = (t + 3, 2t - 5)$.
5. Motion of a point particle in space can be considered as a mapping $M : [a, b] \rightarrow \mathbb{R}^3$, where $[a, b]$ is an interval of the real line. For each $t \in [a, b]$, we define $M(t) = (x(t), y(t), z(t))$, where $x(t)$, $y(t)$, and $z(t)$ are real-valued functions of t . If we identify t with time, which is assumed to have a value in the interval $[a, b]$, then $M(t)$ describes the path of the particle as a function of time, and a and b are the beginning and the end of the motion, respectively.

Let us consider an arbitrary mapping $F : \mathcal{V} \rightarrow \mathcal{W}$ from a vector space \mathcal{V} to another vector space \mathcal{W} . It is assumed that the two vector spaces are over the same scalars, say \mathbb{C} . Consider $|a\rangle$ and $|b\rangle$ in \mathcal{V} and $|x\rangle$ and $|y\rangle$ in \mathcal{W} such that $F(|a\rangle) = |x\rangle$ and $F(|b\rangle) = |y\rangle$. In general, F does not preserve the vector space structure. That is, the image of a linear combination of vectors is not the same as the linear combination of the images:

$$F(\alpha|a\rangle + \beta|b\rangle) \neq \alpha F(|x\rangle) + \beta F(|y\rangle).$$

This is the case for all the mappings of Example 2.3.1. There are many applications in which the preservation of the vector space structure (preservation of the linear combination) is desired.

Definition 2.3.2 A **linear map** (or **transformation**) from the complex vector space \mathcal{V} to the complex vector space \mathcal{W} is a mapping $\mathbf{T} : \mathcal{V} \rightarrow \mathcal{W}$ such that

linear map (or transformation), linear operator, endomorphism

$$\mathbf{T}(\alpha|a\rangle + \beta|b\rangle) = \alpha\mathbf{T}(|a\rangle) + \beta\mathbf{T}(|b\rangle) \quad \forall |a\rangle, |b\rangle \in \mathcal{V} \text{ and } \alpha, \beta \in \mathbb{C}.$$

A linear transformation $\mathbf{T} : \mathcal{V} \rightarrow \mathcal{V}$ is called an **endomorphism** of \mathcal{V} or a **linear operator** on \mathcal{V} . The action of a linear transformation on a vector is written without the parentheses: $\mathbf{T}(|a\rangle) \equiv \mathbf{T}|a\rangle$.

The same definition applies to real vector spaces. Note that the definition demands that both vector spaces have the same set of scalars: The same scalars must multiply vectors in \mathcal{V} on the LHS and those in \mathcal{W} on the RHS.

The set of linear maps from \mathcal{V} to \mathcal{W} is denoted by $\mathcal{L}(\mathcal{V}, \mathcal{W})$, and this set happens to be a vector space. The *zero transformation*, $\mathbf{0}$, is defined to take every vector in \mathcal{V} to the zero vector of \mathcal{W} . The sum of two linear transformations \mathbf{T} and \mathbf{U} is the linear transformation $\mathbf{T} + \mathbf{U}$, whose action on a vector $|a\rangle \in \mathcal{V}$ is defined to be $(\mathbf{T} + \mathbf{U})|a\rangle \equiv \mathbf{T}|a\rangle + \mathbf{U}|a\rangle$. Similarly, define $\alpha\mathbf{T}$ by $(\alpha\mathbf{T})|a\rangle \equiv \alpha(\mathbf{T}|a\rangle) = \alpha\mathbf{T}|a\rangle$. The set of endomorphisms of \mathcal{V} is denoted by $\mathcal{L}(\mathcal{V})$ or $\text{End}(\mathcal{V})$ rather than $\mathcal{L}(\mathcal{V}, \mathcal{V})$. We summarize these observations in

$\mathcal{L}(\mathcal{V}, \mathcal{W})$ is a vector space

Box 2.3.3 $\mathcal{L}(\mathcal{V}, \mathcal{W})$ is a vector space. In particular, so is the set of endomorphisms of a single vector space $\mathcal{L}(\mathcal{V}) \equiv \text{End}(\mathcal{V}) \equiv \mathcal{L}(\mathcal{V}, \mathcal{V})$.

Definition 2.3.4 Let \mathcal{V} and \mathcal{U} be inner product spaces. A linear map $\mathbf{T} : \mathcal{V} \rightarrow \mathcal{U}$ is called an **isometric map** if¹⁰

$$\langle \mathbf{T}a | \mathbf{T}b \rangle = \langle a | b \rangle, \quad \forall |a\rangle, |b\rangle \in \mathcal{V}.$$

¹⁰It is convenient here to use the notation $|\mathbf{T}a\rangle$ for $\mathbf{T}|a\rangle$. This would then allow us to write the dual (see below) of the vector as $\langle \mathbf{T}a|$, emphasizing that it is indeed the bra associated with $\mathbf{T}|a\rangle$.

isometry If $\mathcal{U} = \mathcal{V}$, then \mathbf{T} is called a linear **isometry** or simply an isometry of \mathcal{V} . It is common to call an isometry of a complex (real) \mathcal{V} a **unitary (orthogonal) operator**.

Example 2.3.5 The following are some examples of linear operators in various vector spaces. The proofs of linearity are simple in all cases and are left as exercises for the reader.

1. Let \mathcal{V} be a one-dimensional space (e.g., $\mathcal{V} = \mathbb{C}$). Then any linear endomorphism \mathbf{T} of \mathcal{V} is of the form $\mathbf{T}|x\rangle = \alpha|x\rangle$ with α a scalar. In particular, if \mathbf{T} is an isometry, then $|\alpha|^2 = 1$. If $\mathcal{V} = \mathbb{R}$ and \mathbf{T} is an isometry, then $\mathbf{T}|x\rangle = \pm|x\rangle$.
2. Let π be a permutation (shuffling) of the integers $\{1, 2, \dots, n\}$. If $|x\rangle = (\eta_1, \eta_2, \dots, \eta_n)$ is a vector in \mathbb{C}^n , we can write

$$\mathbf{A}_\pi|x\rangle = (\eta_{\pi(1)}, \eta_{\pi(2)}, \dots, \eta_{\pi(n)}).$$

Then \mathbf{A}_π is a linear operator.

3. For any $|x\rangle \in \mathcal{P}^c[t]$, with $x(t) = \sum_{k=0}^n \alpha_k t^k$, write $|y\rangle = \mathbf{D}|x\rangle$, where $|y\rangle$ is defined as $y(t) = \sum_{k=1}^n k\alpha_k t^{k-1}$. Then \mathbf{D} is a linear operator, the **derivative operator**.
4. For every $|x\rangle \in \mathcal{P}^c[t]$, with $x(t) = \sum_{k=0}^n \alpha_k t^k$, write $|y\rangle = \mathbf{S}|x\rangle$, where $|y\rangle \in \mathcal{P}^c[t]$ is defined as $y(t) = \sum_{k=0}^n [\alpha_k / (k+1)] t^{k+1}$. Then \mathbf{S} is a linear operator, the **integration operator**.
5. Let $\mathcal{C}^n(a, b)$ be the set of real-valued functions defined in the interval $[a, b]$ whose first n derivatives exist and are continuous. For any $|f\rangle \in \mathcal{C}^n(a, b)$ define $|u\rangle = \mathbf{G}|f\rangle$, with $u(t) = g(t)f(t)$ and $g(t)$ a fixed function in $\mathcal{C}^n(a, b)$. Then \mathbf{G} is linear. In particular, the operation of multiplying by t , whose operator is denoted by \mathbf{T} , is linear.

An immediate consequence of Definition 2.3.2 is the following:

Box 2.3.6 Two linear transformations $\mathbf{T} : \mathcal{V} \rightarrow \mathcal{W}$ and $\mathbf{U} : \mathcal{V} \rightarrow \mathcal{W}$ are equal if and only if $\mathbf{T}|a_i\rangle = \mathbf{U}|a_i\rangle$ for all $|a_i\rangle$ in some basis of \mathcal{V} . Thus, a linear transformation is uniquely determined by its action on some basis of its domain space.

The equality in this box is simply the set-theoretic equality of maps discussed in Chap. 1.

The equality of operators can also be established by other, more convenient, methods when an inner product is defined on the vector space. The following two theorems contain the essence of these alternatives.

Theorem 2.3.7 An endomorphism \mathbf{T} of an inner product space is $\mathbf{0}$ if and only if $\langle b|\mathbf{T}|a\rangle \equiv \langle b|\mathbf{T}a\rangle = 0$ for all $|a\rangle$ and $|b\rangle$.

Proof Clearly, if $\mathbf{T} = \mathbf{0}$ then $\langle b|\mathbf{T}|a\rangle = 0$. Conversely, if $\langle b|\mathbf{T}|a\rangle = 0$ for all $|a\rangle$ and $|b\rangle$, then, choosing $|b\rangle = \mathbf{T}|a\rangle = |\mathbf{T}a\rangle$, we obtain

$$\langle \mathbf{T}a|\mathbf{T}a\rangle = 0 \quad \forall |a\rangle \Leftrightarrow \mathbf{T}|a\rangle = 0 \quad \forall |a\rangle \Leftrightarrow \mathbf{T} = \mathbf{0}$$

by positive definiteness of the inner product. □

Theorem 2.3.8 *A linear operator \mathbf{T} on an inner product space is $\mathbf{0}$ if and only if $\langle a|\mathbf{T}|a\rangle = 0$ for all $|a\rangle$.*

Proof Obviously, if $\mathbf{T} = \mathbf{0}$, then $\langle a|\mathbf{T}|a\rangle = 0$. Conversely, choose a vector $\alpha|a\rangle + \beta|b\rangle$, sandwich \mathbf{T} between this vector and its bra, and rearrange terms to obtain what is known as the **polarization identity** polarization identity

$$\begin{aligned} \alpha^*\beta\langle a|\mathbf{T}|b\rangle + \alpha\beta^*\langle b|\mathbf{T}|a\rangle &= \langle \alpha a + \beta b|\mathbf{T}|\alpha a + \beta b\rangle \\ &\quad - |\alpha|^2\langle a|\mathbf{T}|a\rangle - |\beta|^2\langle b|\mathbf{T}|b\rangle. \end{aligned}$$

According to the assumption of the theorem, the RHS is zero. Thus, if we let $\alpha = \beta = 1$ we obtain $\langle a|\mathbf{T}|b\rangle + \langle b|\mathbf{T}|a\rangle = 0$. Similarly, with $\alpha = 1$ and $\beta = i$ we get $i\langle a|\mathbf{T}|b\rangle - i\langle b|\mathbf{T}|a\rangle = 0$. These two equations give $\langle a|\mathbf{T}|b\rangle = 0$ for all $|a\rangle, |b\rangle$. By Theorem 2.3.7, $\mathbf{T} = \mathbf{0}$. □

To show that two operators \mathbf{U} and \mathbf{T} on an inner product space are equal, one can either have them act on an arbitrary vector and show that they give the same result, or one verifies that $\mathbf{U} - \mathbf{T}$ is the zero operator by means of one of the theorems above. Equivalently, one shows that $\langle a|\mathbf{T}|b\rangle = \langle a|\mathbf{U}|b\rangle$ or $\langle a|\mathbf{T}|a\rangle = \langle a|\mathbf{U}|a\rangle$ for all $|a\rangle, |b\rangle$.

2.3.1 Kernel of a Linear Map

It follows immediately from Definition 2.3.2 that the image of the zero vector in \mathcal{V} is the zero vector in \mathcal{W} . This is not true for a general mapping, but it is necessarily true for a linear mapping. As the zero vector of \mathcal{V} is mapped onto the zero vector of \mathcal{W} , other vectors of \mathcal{V} may also be dragged along. In fact, we have the following theorem.

Theorem 2.3.9 *The set of vectors in \mathcal{V} that are mapped onto the zero vector of \mathcal{W} under the linear transformation $\mathbf{T} : \mathcal{V} \rightarrow \mathcal{W}$ form a subspace of \mathcal{V} called the **kernel**, or **null space**, of \mathbf{T} and denoted by $\ker \mathbf{T}$.* kernel of a linear transformation

Proof The proof is left as an exercise. □

The dimension of $\ker \mathbf{T}$ is also called the **nullity** of \mathcal{V} .
The proof of the following is also left as an exercise. nullity

Theorem 2.3.10 *The range $\mathbf{T}(\mathcal{V})$ of a linear map $\mathbf{T} : \mathcal{V} \rightarrow \mathcal{W}$ is a subspace of \mathcal{W} . The dimension of $\mathbf{T}(\mathcal{V})$ is called the **rank** of \mathbf{T} .* rank of a linear transformation

Theorem 2.3.11 *A linear transformation is 1–1 (injective) iff its kernel is zero.*

Proof The “only if” part is trivial. For the “if” part, suppose $\mathbf{T}|a_1\rangle = \mathbf{T}|a_2\rangle$; then linearity of \mathbf{T} implies that $\mathbf{T}(|a_1\rangle - |a_2\rangle) = 0$. Since $\ker \mathbf{T} = 0$,¹¹ we must have $|a_1\rangle = |a_2\rangle$. \square

Theorem 2.3.12 *A linear isometric map is injective.*

Proof Let $\mathbf{T} : \mathcal{V} \rightarrow \mathcal{U}$ be a linear isometry. Let $|a\rangle \in \ker \mathbf{T}$, then

$$\langle a|a\rangle = \langle \mathbf{T}a|\mathbf{T}a\rangle = \langle 0|0\rangle = 0.$$

Therefore, $|a\rangle = |0\rangle$. By Theorem 2.3.11, \mathbf{T} is injective. \square

Suppose we start with a basis of $\ker \mathbf{T}$ and add enough linearly independent vectors to it to get a basis for \mathcal{V} . Without loss of generality, let us assume that the first n vectors in this basis form a basis of $\ker \mathbf{T}$. So let $B = \{|a_1\rangle, |a_2\rangle, \dots, |a_N\rangle\}$ be a basis for \mathcal{V} and $B' = \{|a_1\rangle, |a_2\rangle, \dots, |a_n\rangle\}$ be a basis for $\ker \mathbf{T}$. Here $N = \dim \mathcal{V}$ and $n = \dim \ker \mathbf{T}$. It is straightforward to show that $\{\mathbf{T}|a_{n+1}\rangle, \dots, \mathbf{T}|a_N\rangle\}$ is a basis for $\mathbf{T}(\mathcal{V})$. We therefore have the following result (see also the end of this subsection).

Theorem 2.3.13 *Let $\mathbf{T} : \mathcal{V} \rightarrow \mathcal{W}$ be a linear transformation. Then¹²*

$$\dim \mathcal{V} = \dim \ker \mathbf{T} + \dim \mathbf{T}(\mathcal{V})$$

This theorem is called the **dimension theorem**. One of its consequences is that an injective endomorphism is automatically surjective, and vice versa:

Proposition 2.3.14 *An endomorphism of a finite-dimensional vector space is bijective if it is either injective or surjective.*

The dimension theorem is obviously valid only for finite-dimensional vector spaces. In particular, neither surjectivity nor injectivity implies bijectivity for infinite-dimensional vector spaces.

Example 2.3.15 Let us try to find the kernel of $\mathbf{T} : \mathbb{R}^4 \rightarrow \mathbb{R}^3$ given by

$$\begin{aligned} \mathbf{T}(x_1, x_2, x_3, x_4) \\ = (2x_1 + x_2 + x_3 - x_4, x_1 + x_2 + 2x_3 + 2x_4, x_1 - x_3 - 3x_4). \end{aligned}$$

¹¹Since $\ker \mathbf{T}$ is a set, we should write the equality as $\ker \mathbf{T} = \{|0\rangle\}$, or at least as $\ker \mathbf{T} = \{0\}$. However, when there is no danger of confusion, we set $\{|0\rangle\} = |0\rangle = 0$.

¹²Recall that the dimension of a vector space depends on the scalars used in that space. Although we are dealing with two different vector spaces here, since they are both over the same set of scalars (complex or real), no confusion in the concept of dimension arises.

We must look for (x_1, x_2, x_3, x_4) such that $\mathbf{T}(x_1, x_2, x_3, x_4) = (0, 0, 0)$, or

$$\begin{aligned} 2x_1 + x_2 + x_3 - x_4 &= 0, \\ x_1 + x_2 + 2x_3 + 2x_4 &= 0, \\ x_1 - x_3 - 3x_4 &= 0. \end{aligned}$$

The “solution” to these equations is $x_1 = x_3 + 3x_4$ and $x_2 = -3x_3 - 5x_4$. Thus, to be in $\ker \mathbf{T}$, a vector in \mathbb{R}^4 must be of the form

$$(x_3 + 3x_4, -3x_3 - 5x_4, x_3, x_4) = x_3(1, -3, 1, 0) + x_4(3, -5, 0, 1),$$

where x_3 and x_4 are arbitrary real numbers. It follows that $\ker \mathbf{T}$ consists of vectors that can be written as linear combinations of the two *linearly independent* vectors $(1, -3, 1, 0)$ and $(3, -5, 0, 1)$. Therefore, $\dim \ker \mathbf{T} = 2$. Theorem 2.3.13 then says that $\dim \mathbf{T}(\mathcal{V}) = 2$; that is, the range of \mathbf{T} is two-dimensional. This becomes clear when one notes that

$$\begin{aligned} \mathbf{T}(x_1, x_2, x_3, x_4) \\ = (2x_1 + x_2 + x_3 - x_4)(1, 0, 1) + (x_1 + x_2 + 2x_3 + 2x_4)(0, 1, -1), \end{aligned}$$

and therefore $\mathbf{T}(x_1, x_2, x_3, x_4)$, an arbitrary vector in the range of \mathbf{T} , is a linear combination of *only* two linearly independent vectors, $(1, 0, 1)$ and $(0, 1, -1)$.

2.3.2 Linear Isomorphism

In many cases, two vector spaces may “look” different, while in reality they are very much the same. For example, the set of complex numbers \mathbb{C} is a two-dimensional vector space *over the reals*, as is \mathbb{R}^2 . Although we call the vectors of these two spaces by different names, they have very similar properties. This notion of “similarity” is made precise in the following definition.

Definition 2.3.16 A vector space \mathcal{V} is said to be **isomorphic** to another vector space \mathcal{W} , and written $\mathcal{V} \cong \mathcal{W}$, if there exists a bijective linear map $\mathbf{T}: \mathcal{V} \rightarrow \mathcal{W}$. Then \mathbf{T} is called an **isomorphism**.¹³ A bijective linear map of \mathcal{V} onto itself is called an **automorphism** of \mathcal{V} . An automorphism is also called an **invertible** linear map. The set of automorphisms of \mathcal{V} is denoted by $GL(\mathcal{V})$.

isomorphism and
automorphism

An immediate consequence of the injectivity of an isometry and Proposition 2.3.14 is the following:

¹³The word “isomorphism”, as we shall see, is used in conjunction with many algebraic structures. To distinguish them, qualifiers need to be used. In the present context, we speak of **linear isomorphism**. We shall use qualifiers when necessary. However, the context usually makes the meaning of isomorphism clear.

Proposition 2.3.17 *An isometry of a finite-dimensional vector space is an automorphism of that vector space.*

For all practical purposes, two isomorphic vector spaces are different manifestations of the “same” vector space. In the example discussed above, the correspondence $\mathbf{T} : \mathbb{C} \rightarrow \mathbb{R}^2$, with $\mathbf{T}(x + iy) = (x, y)$, establishes an isomorphism between the two vector spaces. It should be emphasized that *only as vector spaces* are \mathbb{C} and \mathbb{R}^2 isomorphic. If we go beyond the vector space structures, the two sets are quite different. For example, \mathbb{C} has a natural multiplication for its elements, but \mathbb{R}^2 does not. The following three theorems give a working criterion for isomorphism. The proofs are simple and left to the reader.

Theorem 2.3.18 *A linear surjective map $\mathbf{T} : \mathcal{V} \rightarrow \mathcal{W}$ is an isomorphism if and only if its nullity is zero.*

Theorem 2.3.19 *An injective linear transformation $\mathbf{T} : \mathcal{V} \rightarrow \mathcal{W}$ carries linearly independent sets of vectors onto linearly independent sets of vectors.*

Theorem 2.3.20 *Two finite-dimensional vector spaces are isomorphic if and only if they have the same dimension.*

only two N -dimensional vector spaces
 A consequence of Theorem 2.3.20 is that all N -dimensional vector spaces over \mathbb{R} are isomorphic to \mathbb{R}^N and all complex N -dimensional vector spaces are isomorphic to \mathbb{C}^N . So, for all practical purposes, we have only two N -dimensional vector spaces, \mathbb{R}^N and \mathbb{C}^N .

Suppose that $\mathcal{V} = \mathcal{V}_1 \oplus \mathcal{V}_2$ and that \mathbf{T} is an automorphism of \mathcal{V} which leaves \mathcal{V}_1 invariant, i.e., $\mathbf{T}(\mathcal{V}_1) = \mathcal{V}_1$. Then \mathbf{T} leaves \mathcal{V}_2 invariant as well. To see this, first note that if $\mathcal{V} = \mathcal{V}_1 \oplus \mathcal{V}_2$ and $\mathcal{V} = \mathcal{V}_1 \oplus \mathcal{V}'_2$, then $\mathcal{V}_2 = \mathcal{V}'_2$. This can be readily established by looking at a basis of \mathcal{V} obtained by extending a basis of \mathcal{V}_1 . Now note that since $\mathbf{T}(\mathcal{V}) = \mathcal{V}$ and $\mathbf{T}(\mathcal{V}_1) = \mathcal{V}_1$, we must have

$$\mathcal{V}_1 \oplus \mathcal{V}_2 = \mathcal{V} = \mathbf{T}(\mathcal{V}) = \mathbf{T}(\mathcal{V}_1 \oplus \mathcal{V}_2) = \mathbf{T}(\mathcal{V}_1) \oplus \mathbf{T}(\mathcal{V}_2) = \mathcal{V}_1 \oplus \mathbf{T}(\mathcal{V}_2).$$

Hence, by the argument above, $\mathbf{T}(\mathcal{V}_2) = \mathcal{V}_2$. We summarize the discussion as follows:

Proposition 2.3.21 *If $\mathcal{V} = \mathcal{V}_1 \oplus \mathcal{V}_2$, then an automorphism of \mathcal{V} which leaves one of the summands invariant leaves the other invariant as well.*

Example 2.3.22 (Another proof of the dimension theorem) Let \mathbf{T} , \mathcal{V} , and \mathcal{W} be as in Theorem 2.3.13. Let $\mathbf{T}' : \mathcal{V}/\ker \mathbf{T} \rightarrow \mathbf{T}(\mathcal{V})$ be a linear map defined as follows. If $\llbracket a \rrbracket$ is represented by $|a\rangle$, then $\mathbf{T}'(\llbracket a \rrbracket) = \mathbf{T}|a\rangle$. First, we have to show that this map is well defined, i.e., that if $\llbracket a' \rrbracket = \llbracket a \rrbracket$, then $\mathbf{T}'(\llbracket a' \rrbracket) = \mathbf{T}|a\rangle$. But this is trivially true, because $\llbracket a' \rrbracket = \llbracket a \rrbracket$ implies that $|a'\rangle = |a\rangle + |z\rangle$ with $|z\rangle \in \ker \mathbf{T}$. So,

$$\mathbf{T}'(\llbracket a' \rrbracket) \equiv \mathbf{T}|a'\rangle = \mathbf{T}(|a\rangle + |z\rangle) = \mathbf{T}(|a\rangle) + \underbrace{\mathbf{T}(|z\rangle)}_{=|0\rangle} = \mathbf{T}(|a\rangle).$$

One can also easily show that \mathbf{T}' is linear.

We now show that \mathbf{T}' is an isomorphism. Suppose that $|x\rangle \in \mathbf{T}(\mathcal{V})$. Then there is $|y\rangle \in \mathcal{V}$ such that $|x\rangle = \mathbf{T}|y\rangle = \mathbf{T}'(\llbracket y \rrbracket)$. This shows that \mathbf{T}' is surjective. To show that it is injective, let $\mathbf{T}'(\llbracket y \rrbracket) = \mathbf{T}'(\llbracket x \rrbracket)$; then $\mathbf{T}|y\rangle = \mathbf{T}|x\rangle$ or $\mathbf{T}(|y\rangle - |x\rangle) = 0$. This shows that $|y\rangle - |x\rangle \in \ker \mathbf{T}$, i.e., $\llbracket y \rrbracket = \llbracket x \rrbracket$. This isomorphism implies that $\dim(\mathcal{V}/\ker \mathbf{T}) = \dim \mathbf{T}(\mathcal{V})$. Equation (2.2) now yields the result of the dimension theorem.

The result of the preceding example can be generalized as follows

Theorem 2.3.23 *Let \mathcal{V} and \mathcal{W} be vector spaces and $\mathbf{T} : \mathcal{V} \rightarrow \mathcal{W}$ a linear map. Let \mathcal{U} be a subspace of \mathcal{V} . Define $\mathbf{T}' : \mathcal{V}/\mathcal{U} \rightarrow \mathbf{T}(\mathcal{V})$ by $\mathbf{T}'(\llbracket a \rrbracket) = \mathbf{T}|a\rangle$, where $|a\rangle$ is assumed to represent $\llbracket a \rrbracket$. Then \mathbf{T}' is a well defined isomorphism.*

Let \mathcal{U} , \mathcal{V} , and \mathcal{W} be complex vector spaces. Consider the linear map

$$\mathbf{T} : (\mathcal{U} \oplus \mathcal{V}) \otimes \mathcal{W} \rightarrow (\mathcal{U} \otimes \mathcal{W}) \oplus (\mathcal{V} \otimes \mathcal{W})$$

given by

$$\mathbf{T}((|u\rangle + |v\rangle) \otimes |w\rangle) = |u\rangle \otimes |w\rangle + |v\rangle \otimes |w\rangle.$$

It is trivial to show that \mathbf{T} is an isomorphism. We thus have

$$(\mathcal{U} \oplus \mathcal{V}) \otimes \mathcal{W} \cong (\mathcal{U} \otimes \mathcal{W}) \oplus (\mathcal{V} \otimes \mathcal{W}). \quad (2.16)$$

From the fact that $\dim(\mathcal{U} \otimes \mathcal{V}) = \dim \mathcal{U} \dim \mathcal{V}$, we have

$$\mathcal{U} \otimes \mathcal{V} \cong \mathcal{V} \otimes \mathcal{U}. \quad (2.17)$$

Moreover, since $\dim \mathbb{C} = 1$ we have $\dim(\mathbb{C} \otimes \mathcal{V}) = \dim \mathcal{V}$. Hence,

$$\mathbb{C} \otimes \mathcal{V} \cong \mathcal{V} \otimes \mathbb{C} \cong \mathcal{V}. \quad (2.18)$$

Similarly

$$\mathbb{R} \otimes \mathcal{V} \cong \mathcal{V} \otimes \mathbb{R} \cong \mathcal{V}. \quad (2.19)$$

for a real vector space \mathcal{V} .

2.4 Complex Structures

Thus far in our treatment of vector spaces, we have avoided changing the nature of scalars. When we declared that a vector space was complex, we kept the scalars of that vector space complex, and if we used real numbers in that vector space, they were treated as a subset of complex numbers.

In this section, we explore the possibility of changing the scalars, and the corresponding changes in the other structures of the vector space that may ensue. The interesting case is changing the reals to complex numbers.

In the discussion of changing the scalars, as well as other formal treatments of other topics, it is convenient to generalize the concept of inner products. While the notion of positive definiteness is crucial for the physical applications of an inner product, for certain other considerations, it is too restrictive. So, we relax that requirement and define our inner product anew. However, except in this subsection,

Box 2.4.1 *Unless otherwise indicated, all complex inner products are assumed to be sesquilinear as in Definition 2.2.1.*

complex bilinear inner product

Definition 2.4.2 Let \mathbb{F} be either \mathbb{C} or \mathbb{R} . An inner product on an \mathbb{F} -linear space \mathcal{V} is a map $g : \mathcal{V} \times \mathcal{V} \rightarrow \mathbb{F}$ with the following properties:

- (a) symmetry: $g(|a\rangle, |b\rangle) = g(|b\rangle, |a\rangle)$;
- (b) bilinearity: $g(|x\rangle, \alpha|a\rangle + \beta|b\rangle) = \alpha g(|x\rangle, |a\rangle) + \beta g(|x\rangle, |b\rangle)$,
 $g(\alpha|a\rangle + \beta|b\rangle, |x\rangle) = \alpha g(|a\rangle, |x\rangle) + \beta g(|b\rangle, |x\rangle)$;
- (c) nondegeneracy: $g(|x\rangle, |a\rangle) = 0 \quad \forall |x\rangle \in \mathcal{V} \Rightarrow |a\rangle = |0\rangle$;

with $\alpha, \beta \in \mathbb{F}$ and $|a\rangle, |b\rangle, |x\rangle \in \mathcal{V}$.

Non-degeneracy can be restated by saying that for any nonzero $|a\rangle \in \mathcal{V}$, there is at least one vector $|x\rangle \in \mathcal{V}$ such that $g(|x\rangle, |a\rangle) \neq 0$. It is the statement of the fact that the only vector orthogonal to all vectors of an inner product space is the zero vector.

Once again we use the Dirac bra and ket notation for the inner product. However, to distinguish it from the previous inner product, we subscript the notation with \mathbb{F} . Thus the three properties in the definition above are denoted by

- (a) symmetry: $\langle a|b\rangle_{\mathbb{F}} = \langle b|a\rangle_{\mathbb{F}}$;
- (b) bilinearity: $\langle x|\alpha a + \beta b\rangle_{\mathbb{F}} = \alpha \langle x|a\rangle_{\mathbb{F}} + \beta \langle x|b\rangle_{\mathbb{F}}$,
 $\langle \alpha a + \beta b|x\rangle_{\mathbb{F}} = \alpha \langle a|x\rangle_{\mathbb{F}} + \beta \langle b|x\rangle_{\mathbb{F}}$; (2.20)
- (c) non-degeneracy: $\langle x|a\rangle_{\mathbb{F}} = 0 \quad \forall |x\rangle \in \mathcal{V} \Rightarrow |a\rangle = |0\rangle$.

Note that $\langle | \rangle_{\mathbb{F}} = \langle | \rangle$ when $\mathbb{F} = \mathbb{R}$.

Definition 2.4.3 The **adjoint** of an operator $\mathbf{A} \in \text{End}(\mathcal{V})$, denoted by $\mathbf{A}^{\mathbf{T}}$, is defined by

adjoint, self-adjoint, skew $\langle \mathbf{A}a|b\rangle_{\mathbb{F}} = \langle a|\mathbf{A}^{\mathbf{T}}b\rangle_{\mathbb{F}}$ or $\langle a|\mathbf{A}^{\mathbf{T}}|b\rangle_{\mathbb{F}} = \langle b|\mathbf{A}|a\rangle_{\mathbb{F}}$.

An operator \mathbf{A} is called **self-adjoint** if $\mathbf{A}^{\mathbf{T}} = \mathbf{A}$, and **skew** if $\mathbf{A}^{\mathbf{T}} = -\mathbf{A}$.

From this definition and the non-degeneracy of $\langle | \rangle_{\mathbb{F}}$ it follows that

$$(\mathbf{A}^{\mathbf{T}})^{\mathbf{T}} = \mathbf{A}. \quad (2.21)$$

Proposition 2.4.4 An operator $\mathbf{A} \in \text{End}(\mathcal{V})$ is skew iff $\langle x|\mathbf{A}x\rangle_{\mathbb{F}} \equiv \langle x|\mathbf{A}|x\rangle_{\mathbb{F}} = 0$ for all $|x\rangle \in \mathcal{V}$.

Proof If \mathbf{A} is skew, then

$$\langle x|\mathbf{A}|x\rangle_{\mathbb{F}} = \langle x|\mathbf{A}^{\top}|x\rangle_{\mathbb{F}} = -\langle x|\mathbf{A}|x\rangle_{\mathbb{F}} \Rightarrow \langle x|\mathbf{A}|x\rangle_{\mathbb{F}} = 0.$$

Conversely, suppose that $\langle x|\mathbf{A}|x\rangle_{\mathbb{F}} = 0$ for all $|x\rangle \in \mathcal{V}$, then for nonzero $\alpha, \beta \in \mathbb{F}$ and nonzero $|a\rangle, |b\rangle \in \mathcal{V}$,

$$\begin{aligned} 0 &= \langle \alpha a + \beta b|\mathbf{A}|\alpha a + \beta b\rangle_{\mathbb{F}} \\ &= \alpha^2 \underbrace{\langle a|\mathbf{A}|a\rangle_{\mathbb{F}}}_{=0} + \alpha\beta \langle a|\mathbf{A}|b\rangle_{\mathbb{F}} + \alpha\beta \langle b|\mathbf{A}|a\rangle_{\mathbb{F}} + \beta^2 \underbrace{\langle b|\mathbf{A}|b\rangle_{\mathbb{F}}}_{=0} \\ &= \alpha\beta (\langle b|\mathbf{A}|a\rangle_{\mathbb{F}} + \langle b|\mathbf{A}^{\top}|a\rangle_{\mathbb{F}}). \end{aligned}$$

Since $\alpha\beta \neq 0$, we must have $\langle b|(\mathbf{A} + \mathbf{A}^{\top})|a\rangle_{\mathbb{F}} = 0$ for all nonzero $|a\rangle, |b\rangle \in \mathcal{V}$. By non-degeneracy of the inner product, $(\mathbf{A} + \mathbf{A}^{\top})|a\rangle = |0\rangle$. Since this is true for all $|a\rangle \in \mathcal{V}$, we must have $\mathbf{A}^{\top} = -\mathbf{A}$. \square

Comparing this proposition with Theorem 2.3.8 shows how strong a restriction the positive definiteness imposes on the inner product.

Definition 2.4.5 A complex structure \mathbf{J} on a real vector space \mathcal{V} is a linear operator which satisfies $\mathbf{J}^2 = -\mathbf{1}$ and $\langle \mathbf{J}a|\mathbf{J}b\rangle = \langle a|b\rangle$ for all $|a\rangle, |b\rangle \in \mathcal{V}$.

complex structure

Proposition 2.4.6 The complex structure \mathbf{J} is skew.

Proof Let $|a\rangle \in \mathcal{V}$ and $|b\rangle = \mathbf{J}|a\rangle$. Then recalling that $\langle | \rangle_{\mathbb{R}} = \langle | \rangle$, on the one hand,

$$\langle a|\mathbf{J}a\rangle = \langle a|b\rangle = \langle \mathbf{J}a|\mathbf{J}b\rangle = \langle \mathbf{J}a|\mathbf{J}^2a\rangle = -\langle \mathbf{J}a|a\rangle.$$

On the other hand,

$$\langle a|\mathbf{J}a\rangle = \langle a|b\rangle = \langle b|a\rangle = \langle \mathbf{J}a|a\rangle.$$

These two equations show that $\langle a|\mathbf{J}a\rangle = 0$ for all $|a\rangle \in \mathcal{V}$. Hence, by Proposition 2.4.4, \mathbf{J} is skew. \square

Let $|a\rangle$ be any vector in the N -dimensional real inner product space. Normalize $|a\rangle$ to get the unit vector $|e_1\rangle$. By Propositions 2.4.4 and 2.4.6, $\mathbf{J}|e_1\rangle$ is orthogonal to $|e_1\rangle$. Normalize $\mathbf{J}|e_1\rangle$ to get $|e_2\rangle$. If $N > 2$, let $|e_3\rangle$ be any unit vector orthogonal to $|e_1\rangle$ and $|e_2\rangle$. Then $|a_3\rangle \equiv \mathbf{J}|e_3\rangle$ is obviously orthogonal to $|e_3\rangle$. We claim that it is also orthogonal to both $|e_1\rangle$ and $|e_2\rangle$:

$$\begin{aligned} \langle e_1|a_3\rangle &= \langle \mathbf{J}e_1|\mathbf{J}a_3\rangle = \langle \mathbf{J}e_1|\mathbf{J}^2e_3\rangle \\ &= -\langle \mathbf{J}e_1|e_3\rangle = -\langle e_2|e_3\rangle = 0 \\ \langle e_2|a_3\rangle &= \langle \mathbf{J}e_2|\mathbf{J}e_3\rangle = \langle e_1|e_3\rangle = 0. \end{aligned}$$

Continuing this process, we can prove the following:

Theorem 2.4.7 The vectors $\{|e_i\rangle, \mathbf{J}|e_i\rangle\}_{i=1}^m$ with $N = 2m$ form an orthonormal basis for the real vector space \mathcal{V} with inner product $\langle \cdot | \cdot \rangle_{\mathbb{R}} = \langle \cdot | \cdot \rangle$. In particular, \mathcal{V} must be even-dimensional for it to have a complex structure \mathbf{J} .

Definition 2.4.8 If \mathcal{V} is a real vector space, then $\mathbb{C} \otimes \mathcal{V}$, together with the complex multiplication rule

$$\alpha(\beta \otimes |a\rangle) = (\alpha\beta) \otimes |a\rangle, \quad \alpha, \beta \in \mathbb{C},$$

is a complex vector space called the **complexification** of \mathcal{V} and denoted by $\mathcal{V}^{\mathbb{C}}$. In particular, $(\mathbb{R}^n)^{\mathbb{C}} \equiv \mathbb{C} \otimes \mathbb{R}^n \cong \mathbb{C}^n$.

Note that $\dim_{\mathbb{C}} \mathcal{V}^{\mathbb{C}} = \dim_{\mathbb{R}} \mathcal{V}$ and $\dim_{\mathbb{R}} \mathcal{V}^{\mathbb{C}} = 2 \dim_{\mathbb{R}} \mathcal{V}$. In fact, if $\{|a_k\rangle\}_{k=1}^N$ is a basis of \mathcal{V} , then it is also a basis of $\mathcal{V}^{\mathbb{C}}$ as a *complex* vector space, while $\{|a_k\rangle, i|a_k\rangle\}_{k=1}^N$ is a basis of $\mathcal{V}^{\mathbb{C}}$ as a *real* vector space.

After complexifying a real vector space \mathcal{V} with inner product $\langle \cdot | \cdot \rangle_{\mathbb{R}} = \langle \cdot | \cdot \rangle$, we can define an inner product on it which is sesquilinear (or hermitian) as follows

$$\langle \alpha \otimes a | \beta \otimes b \rangle \equiv \bar{\alpha}\beta \langle a | b \rangle.$$

It is left to the reader to show that this inner product satisfies all the properties given in Definition 2.2.1.

To complexify a real vector space \mathcal{V} , we have to “multiply” it by the set of complex numbers: $\mathcal{V}^{\mathbb{C}} = \mathbb{C} \otimes \mathcal{V}$. As a result, we get a *real* vector space of twice the original dimension. Is there a reverse process, a “division” of a (necessarily even-dimensional) real vector space? That is, is there a way of getting a complex vector space of half complex dimension, starting with an even-dimensional real vector space?

Let \mathcal{V} be a $2m$ -dimensional real vector space. Let \mathbf{J} be a complex structure on \mathcal{V} , and $\{|e_i\rangle, \mathbf{J}|e_i\rangle\}_{i=1}^m$ a basis of \mathcal{V} . On the subspace $\mathcal{V}_1 \equiv \text{Span}\{|e_i\rangle\}_{i=1}^m$, define the multiplication by a complex number by

$$(\alpha + i\beta) \otimes |v_1\rangle \equiv (\alpha \mathbf{1} + \beta \mathbf{J})|v_1\rangle, \quad \alpha, \beta \in \mathbb{R}, \quad |v_1\rangle \in \mathcal{V}_1. \quad (2.22)$$

It is straightforward to show that this process turns the $2m$ -dimensional real vector space \mathcal{V} into the m -dimensional complex vector space $\mathcal{V}_1^{\mathbb{C}}$.

2.5 Linear Functionals

An important example of a linear transformation occurs when the second vector space, \mathcal{W} , happens to be the set of scalars, \mathbb{C} or \mathbb{R} , in which case the linear transformation is called a **linear functional**. The set of linear functionals $\mathcal{L}(\mathcal{V}, \mathbb{C})$ —or $\mathcal{L}(\mathcal{V}, \mathbb{R})$ if \mathcal{V} is a real vector space—is denoted by \mathcal{V}^* and is called the **dual space** of \mathcal{V} .

linear functional
dual vector space \mathcal{V}^*

Example 2.5.1 Here are some examples of linear functionals:

- (a) Let $|a\rangle = (\alpha_1, \alpha_2, \dots, \alpha_n)$ be in \mathbb{C}^n . Define $\phi : \mathbb{C}^n \rightarrow \mathbb{C}$ by

$$\phi(|a\rangle) = \sum_{k=1}^n \alpha_k.$$

Then it is easy to show that ϕ is a linear functional.

- (b) Let μ_{ij} denote the elements of an $m \times n$ matrix M . Define $\omega : \mathcal{M}^{m \times n} \rightarrow \mathbb{C}$ by

$$\omega(M) = \sum_{i=1}^m \sum_{j=1}^n \mu_{ij}.$$

Then it is easy to show that ω is a linear functional.

- (c) Let μ_{ij} denote the elements of an $n \times n$ matrix M . Define $\theta : \mathcal{M}^{n \times n} \rightarrow \mathbb{C}$ by

$$\theta(M) = \sum_{j=1}^n \mu_{jj},$$

the sum of the diagonal elements of M . Then it is routine to show that θ is a linear functional.

- (d) Define the operator **int** : $\mathcal{C}^0(a, b) \rightarrow \mathbb{R}$ by

$$\mathbf{int}(f) = \int_a^b f(t) dt.$$

integration is a linear functional on the space of continuous functions

Then **int** is a linear functional on the vector space $\mathcal{C}^0(a, b)$.

- (e) Let \mathcal{V} be a complex inner product space. Fix $|a\rangle \in \mathcal{V}$, and let $\gamma_a : \mathcal{V} \rightarrow \mathbb{C}$ be defined by

$$\gamma_a(|b\rangle) = \langle a|b\rangle.$$

Then one can show that γ_a is a linear functional.

- (f) Let $\{|a_1\rangle, |a_2\rangle, \dots, |a_m\rangle\}$ be an arbitrary finite set of vectors in \mathcal{V} , and $\{\phi_1, \phi_2, \dots, \phi_m\}$ an arbitrary set of linear functionals on \mathcal{V} . Let

$$\mathbf{A} \equiv \sum_{k=1}^m |a_k\rangle \phi_k \in \text{End}(\mathcal{V})$$

be defined by

$$\mathbf{A}|x\rangle = \sum_{k=1}^m |a_k\rangle \phi_k(|x\rangle) = \sum_{k=1}^m \phi_k(|x\rangle) |a_k\rangle.$$

Then \mathbf{A} is a linear operator on \mathcal{V} .

An example of linear isomorphism is that between a vector space and its dual space, which we discuss now. Consider an N -dimensional vector space with a basis $B = \{|a_1\rangle, |a_2\rangle, \dots, |a_N\rangle\}$. For any given set of N scalars,

$\{\alpha_1, \alpha_2, \dots, \alpha_N\}$, define the linear functional ϕ_α by $\phi_\alpha|a_i\rangle = \alpha_i$. When ϕ_α acts on any arbitrary vector $|b\rangle = \sum_{i=1}^N \beta_i|a_i\rangle$ in \mathcal{V} , the result is

$$\phi_\alpha|b\rangle = \phi_\alpha\left(\sum_{i=1}^N \beta_i|a_i\rangle\right) = \sum_{i=1}^N \beta_i\phi_\alpha|a_i\rangle = \sum_{i=1}^N \beta_i\alpha_i. \quad (2.23)$$

This expression suggests that $|b\rangle$ can be represented as a column vector with entries $\beta_1, \beta_2, \dots, \beta_N$ and ϕ_α as a row vector with entries $\alpha_1, \alpha_2, \dots, \alpha_N$. Then $\phi_\alpha|b\rangle$ is merely the matrix product¹⁴ of the row vector (on the left) and the column vector (on the right).

ϕ_α is uniquely determined by the set $\{\alpha_1, \alpha_2, \dots, \alpha_N\}$. In other words, corresponding to every set of N scalars there exists a unique linear functional. This leads us to a particular set of functionals, $\phi_1, \phi_2, \dots, \phi_N$ corresponding, respectively, to the sets of scalars $\{1, 0, 0, \dots, 0\}, \{0, 1, 0, \dots, 0\}, \dots, \{0, 0, 0, \dots, 1\}$. This means that

Every set of N scalars
defines a linear
functional.

$$\begin{aligned} \phi_1|a_1\rangle &= 1 & \text{and} & & \phi_1|a_j\rangle &= 0 & \text{for } j \neq 1, \\ \phi_2|a_2\rangle &= 1 & \text{and} & & \phi_2|a_j\rangle &= 0 & \text{for } j \neq 2, \\ & \vdots & & & \vdots & & \vdots \\ \phi_N|a_N\rangle &= 1 & \text{and} & & \phi_N|a_j\rangle &= 0 & \text{for } j \neq N, \end{aligned}$$

or that

$$\phi_i|a_j\rangle = \delta_{ij}, \quad (2.24)$$

where δ_{ij} is the Kronecker delta.

The functionals of Eq. (2.24) form a basis of the dual space \mathcal{V}^* . To show this, consider an arbitrary $\gamma \in \mathcal{V}^*$, which is uniquely determined by its action on the vectors in a basis $B = \{|a_1\rangle, |a_2\rangle, \dots, |a_N\rangle\}$. Let $\gamma|a_i\rangle = \gamma_i \in \mathbb{C}$. Then we claim that $\gamma = \sum_{i=1}^N \gamma_i\phi_i$. In fact, consider an arbitrary vector $|a\rangle$ in \mathcal{V} with components $(\alpha_1, \alpha_2, \dots, \alpha_N)$ with respect to B . Then, on the one hand,

$$\gamma|a\rangle = \gamma\left(\sum_{i=1}^N \alpha_i|a_i\rangle\right) = \sum_{i=1}^N \alpha_i\gamma|a_i\rangle = \sum_{i=1}^N \alpha_i\gamma_i.$$

On the other hand,

$$\begin{aligned} \left(\sum_{i=1}^N \gamma_i\phi_i\right)|a\rangle &= \left(\sum_{i=1}^N \gamma_i\phi_i\right)\left(\sum_{j=1}^N \alpha_j|a_j\rangle\right) \\ &= \sum_{i=1}^N \gamma_i \sum_{j=1}^N \alpha_j\phi_i|a_j\rangle = \sum_{i=1}^N \gamma_i \sum_{j=1}^N \alpha_j\delta_{ij} = \sum_{i=1}^N \gamma_i\alpha_i. \end{aligned}$$

¹⁴Matrices will be taken up in Chap. 5. Here, we assume only a nodding familiarity with elementary matrix operations.

Since the actions of $\boldsymbol{\gamma}$ and $\sum_{i=1}^N \gamma_i \boldsymbol{\phi}_i$ yield equal results for arbitrary $|a\rangle$, we conclude that $\boldsymbol{\gamma} = \sum_{i=1}^N \gamma_i \boldsymbol{\phi}_i$, i.e., $\{\boldsymbol{\phi}_i\}_{i=1}^N$ span \mathcal{V}^* . Thus, we have the following result.

Theorem 2.5.2 For every basis $B = \{|a_j\rangle\}_{j=1}^N$ in \mathcal{V} , there corresponds a unique basis $B^* = \{\boldsymbol{\phi}_i\}_{i=1}^N$ in \mathcal{V}^* with the property that $\boldsymbol{\phi}_i |a_j\rangle = \delta_{ij}$.

By this theorem the dual space of an N -dimensional vector space is also N -dimensional, and thus isomorphic to it. The basis B^* is called the **dual basis** of B . A corollary to Theorem 2.5.2 is that to every vector in \mathcal{V} there corresponds a *unique* linear functional in \mathcal{V}^* . This can be seen by noting that every vector $|a\rangle$ is uniquely determined by its components $(\alpha_1, \alpha_2, \dots, \alpha_N)$ in a basis B . The unique linear functional $\boldsymbol{\phi}_a$ corresponding to $|a\rangle$, also called the dual of $|a\rangle$, is simply $\sum_{i=1}^N \alpha_i \boldsymbol{\phi}_i$, with $\boldsymbol{\phi}_i \in B^*$.

dual basis

Definition 2.5.3 An **annihilator** of $|a\rangle \in \mathcal{V}$ is a linear functional $\boldsymbol{\phi} \in \mathcal{V}^*$ such that $\boldsymbol{\phi}|a\rangle = 0$. Let \mathcal{W} be a subspace of \mathcal{V} . The set of linear functionals in \mathcal{V}^* that annihilate all vectors in \mathcal{W} is denoted by \mathcal{W}^0 .

annihilator of a vector and a subspace

The reader may check that \mathcal{W}^0 is a subspace of \mathcal{V}^* . Moreover, if we extend a basis $\{|a_i\rangle\}_{i=1}^k$ of \mathcal{W} to a basis $B = \{|a_i\rangle\}_{i=1}^N$ of \mathcal{V} , then we can show that the functionals $\{\boldsymbol{\phi}_j\}_{j=k+1}^N$, chosen from the basis $B^* = \{\boldsymbol{\phi}_j\}_{j=1}^N$ dual to B , span \mathcal{W}^0 . It then follows that

$$\dim \mathcal{V} = \dim \mathcal{W} + \dim \mathcal{W}^0. \tag{2.25}$$

We shall have occasions to use annihilators later on when we discuss symplectic geometry.

dual, or pull back, of a linear transformation

We have “dualized” a vector, a basis, and a complete vector space. The only object remaining is a linear transformation.

Definition 2.5.4 Let $\mathbf{T} : \mathcal{V} \rightarrow \mathcal{U}$ be a linear map. Define $\mathbf{T}^* : \mathcal{U}^* \rightarrow \mathcal{V}^*$ by¹⁵

$$[\mathbf{T}^*(\boldsymbol{\gamma})]|a\rangle = \boldsymbol{\gamma}(\mathbf{T}|a\rangle) \quad \forall |a\rangle \in \mathcal{V}, \boldsymbol{\gamma} \in \mathcal{U}^*,$$

\mathbf{T}^* is called the **dual** or **pullback**, of \mathbf{T} .

One can readily verify that $\mathbf{T}^* \in \mathcal{L}(\mathcal{U}^*, \mathcal{V}^*)$, i.e., that \mathbf{T}^* is a *linear* operator on \mathcal{U}^* . Some of the mapping properties of \mathbf{T}^* are tied to those of \mathbf{T} . To see this we first consider the kernel of \mathbf{T}^* . Clearly, $\boldsymbol{\gamma}$ is in the kernel of \mathbf{T}^* if and only if $\boldsymbol{\gamma}$ annihilates all vectors of the form $\mathbf{T}|a\rangle$, i.e., all vectors in $\mathbf{T}(\mathcal{V})$. It follows that $\boldsymbol{\gamma}$ is in $\mathbf{T}(\mathcal{V})^0$. In particular, if \mathbf{T} is surjective, $\mathbf{T}(\mathcal{V}) = \mathcal{U}$, and $\boldsymbol{\gamma}$ annihilates all vectors in \mathcal{U} , i.e., it is the zero linear functional. We conclude that $\ker \mathbf{T}^* = 0$, and therefore, \mathbf{T}^* is injective. Similarly, one can show that if \mathbf{T} is injective, then \mathbf{T}^* is surjective. We summarize the discussion above:

¹⁵Do not confuse this “*” with complex conjugation.

Proposition 2.5.5 *Let \mathbf{T} be a linear transformation and \mathbf{T}^* its pull back. Then $\ker \mathbf{T}^* = \mathbf{T}(\mathcal{V})^0$. If \mathbf{T} is surjective (injective), then \mathbf{T}^* is injective (surjective). In particular, \mathbf{T}^* is an isomorphism if \mathbf{T} is.*

It is useful to make a connection between the inner product and linear functionals. To do this, consider a basis $\{|a_1\rangle, |a_2\rangle, \dots, |a_N\rangle\}$ and let $\alpha_i = \langle a|a_i\rangle$. As noted earlier, the set of scalars $\{\alpha_i\}_{i=1}^N$ defines a unique linear functional γ_a (see Example 2.5.1) such that $\gamma_a|a_i\rangle = \alpha_i$. Since $\langle a|a_i\rangle$ is also equal to α_i , it is natural to identify γ_a with the symbol $\langle a|$, and write $\gamma_a \mapsto \langle a|$.

It is also convenient to introduce the notation¹⁶

$$(|a\rangle)^\dagger \equiv \langle a|, \quad (2.26)$$

dagger of a linear combination of vectors

where the symbol \dagger means “dual, or dagger of”. Now we ask: How does this dagger operation act on a linear combination of vectors? Let $|c\rangle = \alpha|a\rangle + \beta|b\rangle$ and take the inner product of $|c\rangle$ with an arbitrary vector $|x\rangle$ using linearity in the second factor: $\langle x|c\rangle = \alpha\langle x|a\rangle + \beta\langle x|b\rangle$. Now complex conjugate both sides and use the (sesqui)symmetry of the inner product:

$$\begin{aligned} (\text{LHS})^* &= \langle x|c\rangle^* = \langle c|x\rangle, \\ (\text{RHS})^* &= \alpha^*\langle x|a\rangle^* + \beta^*\langle x|b\rangle^* = \alpha^*\langle a|x\rangle + \beta^*\langle b|x\rangle \\ &= (\alpha^*\langle a| + \beta^*\langle b|)|x\rangle. \end{aligned}$$

Since this is true for all $|x\rangle$, we must have $(|c\rangle)^\dagger \equiv \langle c| = \alpha^*\langle a| + \beta^*\langle b|$. Therefore, in a duality “operation” the complex scalars must be conjugated. So, we have

$$(\alpha|a\rangle + \beta|b\rangle)^\dagger = \alpha^*\langle a| + \beta^*\langle b|. \quad (2.27)$$

Thus, unlike the association $|a\rangle \mapsto \gamma_a$ which is linear, the association $\gamma_a \mapsto \langle a|$ is not linear, but sesquilinear:

$$\gamma_{\alpha a + \beta b} \mapsto \alpha^*\langle a| + \beta^*\langle b|.$$

It is convenient to represent $|a\rangle \in \mathbb{C}^n$ as a column vector

$$|a\rangle = \begin{pmatrix} \alpha_1 \\ \alpha_2 \\ \vdots \\ \alpha_n \end{pmatrix}.$$

Then the definition of the complex inner product suggests that the dual of $|a\rangle$ must be represented as a row vector with complex conjugate entries:

$$\langle a| = (\alpha_1^* \quad \alpha_2^* \quad \dots \quad \alpha_n^*), \quad (2.28)$$

¹⁶The significance of this notation will become clear in Sect. 4.3.

and the inner product can be written as the (matrix) product

$$\langle a|b \rangle = \begin{pmatrix} \alpha_1^* & \alpha_2^* & \cdots & \alpha_n^* \end{pmatrix} \begin{pmatrix} \beta_1 \\ \beta_2 \\ \vdots \\ \beta_n \end{pmatrix} = \sum_{i=1}^n \alpha_i^* \beta_i.$$

Compare (2.28) with the comments after (2.23). The complex conjugation in (2.28) is the result of the sesquilinearity of the association $|a\rangle \leftrightarrow \langle a|$.

2.6 Multilinear Maps

There is a very useful generalization of the linear functionals that becomes essential in the treatment of tensors later in the book. However, a limited version of its application is used in the discussion of determinants, which we shall start here.

Definition 2.6.1 Let \mathcal{V} and \mathcal{U} be vector spaces. Let \mathcal{V}^p denote the p -fold Cartesian product of \mathcal{V} . A **p-linear map** from \mathcal{V} to \mathcal{U} is a map $\theta : \mathcal{V}^p \rightarrow \mathcal{U}$ which is linear with respect to each of its arguments:

$$\begin{aligned} &\theta(|a_1\rangle, \dots, \alpha|a_j\rangle + \beta|b_j\rangle, \dots, |a_p\rangle) \\ &= \alpha\theta(|a_1\rangle, \dots, |a_j\rangle, \dots, |a_p\rangle) + \beta\theta(|a_1\rangle, \dots, |b_j\rangle, \dots, |a_p\rangle). \end{aligned}$$

A p -linear map from \mathcal{V} to \mathbb{C} or \mathbb{R} is called a **p-linear function** in \mathcal{V} .

As an example, let $\{\phi_i\}_{i=1}^p$ be linear functionals on \mathcal{V} . Define θ by

$$\theta(|a_1\rangle, \dots, |a_p\rangle) = \phi_1(|a_1\rangle) \dots \phi_p(|a_p\rangle), \quad |a_i\rangle \in \mathcal{V}.$$

Clearly θ is p -linear.

Let σ denote a permutation of $1, 2, \dots, p$. Define the p -linear map $\sigma\omega$ by

$$\sigma\omega(|a_1\rangle, \dots, |a_p\rangle) = \omega(|a_{\sigma(1)}\rangle, \dots, |a_{\sigma(p)}\rangle)$$

Definition 2.6.2 A p -linear map ω from \mathcal{V} to \mathcal{U} is **skew-symmetric** if $\sigma\omega = \epsilon_\sigma \cdot \omega$, i.e., if

$$\omega(|a_{\sigma(1)}\rangle, \dots, |a_{\sigma(p)}\rangle) = \epsilon_\sigma \omega(|a_1\rangle, \dots, |a_p\rangle)$$

where ϵ_σ is the sign of σ , which is $+1$ if σ is even and -1 if it is odd. The set of p -linear skew-symmetric maps from \mathcal{V} to \mathcal{U} is denoted by $\Lambda^p(\mathcal{V}, \mathcal{U})$. The set of p -linear skew-symmetric functions in \mathcal{V} is denoted by $\Lambda^p(\mathcal{V})$.

The permutation sign ϵ_σ is sometimes written as

$$\epsilon_\sigma = \epsilon_{\sigma(1)\sigma(2)\dots\sigma(p)} \equiv \epsilon_{i_1 i_2 \dots i_p}, \tag{2.29}$$

where $i_k \equiv \sigma(k)$.

Any p -linear map can be turned into a skew-symmetric p -linear map. In fact, if θ is a p -linear map, then

$$\omega \equiv \sum_{\pi} \epsilon_{\pi} \cdot \pi \theta \quad (2.30)$$

is skew-symmetric:

$$\begin{aligned} \sigma \omega &= \sigma \sum_{\pi} \epsilon_{\pi} \cdot \pi \theta = \sum_{\pi} \epsilon_{\pi} \cdot (\sigma \pi) \theta = (\epsilon_{\sigma})^2 \sum_{\pi} \epsilon_{\pi} \cdot (\sigma \pi) \theta \\ &= \epsilon_{\sigma} \sum_{\pi} (\epsilon_{\sigma} \epsilon_{\pi}) \cdot (\sigma \pi) \theta = \epsilon_{\sigma} \sum_{\sigma \pi} \epsilon_{\sigma \pi} \cdot (\sigma \pi) \theta = \epsilon_{\sigma} \cdot \omega, \end{aligned}$$

where we have used the fact that the sign of the product is the product of the signs of two permutations, and if \sum_{π} sums over all permutations, then so does $\sum_{\sigma \pi}$.

The following theorem can be proved using properties of permutations:

Theorem 2.6.3 *Let $\omega \in \Lambda^p(\mathcal{V}, \mathcal{U})$. Then the following statements are equivalent:*

1. $\omega(|a_1\rangle, \dots, |a_p\rangle) = 0$ whenever $|a_i\rangle = |a_j\rangle$ for some pair $i \neq j$.
2. $\omega(|a_{\sigma(1)}\rangle, \dots, |a_{\sigma(p)}\rangle) = \epsilon_{\sigma} \omega(|a_1\rangle, \dots, |a_p\rangle)$, for any permutation σ of $1, 2, \dots, p$, and any $|a_1\rangle, \dots, |a_p\rangle$ in \mathcal{V} .
3. $\omega(|a_1\rangle, \dots, |a_p\rangle) = 0$ whenever $\{|a_k\rangle\}_{k=1}^p$ are linearly dependent.

Proposition 2.6.4 *Let $N = \dim \mathcal{V}$ and $\omega \in \Lambda^N(\mathcal{V}, \mathcal{U})$. Then ω is determined uniquely by its value on a basis of \mathcal{V} . In particular, if ω vanishes on a basis, then $\omega = \mathbf{0}$.*

Proof Let $\{|e_k\rangle\}_{k=1}^N$ be a basis of \mathcal{V} . Let $\{|a_j\rangle\}_{j=1}^N$ be any set of vectors in \mathcal{V} and write $|a_j\rangle = \sum_{k=1}^N \alpha_{jk} |e_k\rangle$ for $j = 1, \dots, N$. Then

$$\begin{aligned} \omega(|a_1\rangle, \dots, |a_N\rangle) &= \sum_{k_1 \dots k_N=1}^N \alpha_{1k_1} \dots \alpha_{Nk_N} \omega(|e_{k_1}\rangle, \dots, |e_{k_N}\rangle) \\ &\equiv \sum_{\pi} \alpha_{1\pi(1)} \dots \alpha_{N\pi(N)} \omega(|e_{\pi(1)}\rangle, \dots, |e_{\pi(N)}\rangle) \\ &= \left(\sum_{\pi} \epsilon_{\pi} \alpha_{1\pi(1)} \dots \alpha_{N\pi(N)} \right) \omega(|e_1\rangle, \dots, |e_N\rangle). \end{aligned}$$

Since the term in parentheses is a constant, we are done. \square

Definition 2.6.5 A skew symmetric N -linear function in \mathcal{V} , i.e., a member of $\Lambda^N(\mathcal{V})$ is called a **determinant function** in \mathcal{V} .

Determinant function

Let $B = \{|e_k\rangle\}_{k=1}^N$ be a basis of \mathcal{V} and $B^* = \{\epsilon_j\}_{j=1}^N$ a basis of \mathcal{V}^* , dual to B . For any set of N vectors $\{|a_k\rangle\}_{k=1}^N$ in \mathcal{V} , define the N -linear function θ by

$$\theta(|a_1\rangle, \dots, |a_N\rangle) = \epsilon_1(|a_1\rangle) \dots \epsilon_N(|a_N\rangle),$$

and note that

$$\pi\theta(|e_1\rangle, \dots, |e_N\rangle) \equiv \theta(|e_{\pi(1)}\rangle, \dots, |e_{\pi(N)}\rangle) = \delta_{\iota\pi},$$

where ι is the identity permutation and $\delta_{\iota\pi} = 1$ if $\pi = \iota$ and $\delta_{\iota\pi} = 0$ if $\pi \neq \iota$. Now let Δ be defined by $\Delta \equiv \sum_{\pi} \epsilon_{\pi} \cdot \pi\theta$. Then, by Eq. (2.30), $\Delta \in \Lambda^N(\mathcal{V})$, i.e., Δ is a determinant function. Furthermore,

$$\Delta(|e_1\rangle, \dots, |e_N\rangle) = \sum_{\pi} \epsilon_{\pi} \cdot \pi\theta(|e_1\rangle, \dots, |e_N\rangle) = \sum_{\pi} \epsilon_{\pi} \delta_{\iota\pi} = \epsilon_{\iota} = 1$$

Therefore, we have the following:

Box 2.6.6 *In every finite-dimensional vector space, there are determinant functions which are not identically zero.*

Proposition 2.6.7 *Let $\omega \in \Lambda^N(\mathcal{V}, \mathcal{U})$. Let Δ be a fixed nonzero determinant function in \mathcal{V} . Then ω determines a unique $|u_{\Delta}\rangle \in \mathcal{U}$ such that*

$$\omega(|v_1\rangle, \dots, |v_N\rangle) = \Delta(|v_1\rangle, \dots, |v_N\rangle) \cdot |u_{\Delta}\rangle.$$

Proof Let $\{|v_k\rangle\}_{k=1}^N$ be a basis of \mathcal{V} such that $\Delta(|v_1\rangle, \dots, |v_N\rangle) \neq 0$. By dividing one of the vectors (or Δ) by a constant, we can assume that $\Delta(|v_1\rangle, \dots, |v_N\rangle) = 1$. Denote $\omega(|v_1\rangle, \dots, |v_N\rangle)$ by $|u_{\Delta}\rangle$. Now note that $\omega - \Delta \cdot |u_{\Delta}\rangle$ yields zero on the basis $\{|v_k\rangle\}_{k=1}^N$. By Proposition 2.6.4, it must be identically zero. \square

Corollary 2.6.8 *Let Δ be a fixed nonzero determinant function in \mathcal{V} . Then every determinant function is a scalar multiple of Δ .*

Proof Let \mathcal{U} be \mathbb{C} or \mathbb{R} in Proposition 2.6.7. \square

Proposition 2.6.9 *Let Δ be a determinant function in the N -dimensional vector space \mathcal{V} . Let $|v\rangle$ and $\{|v_k\rangle\}_{k=1}^N$ be vectors in \mathcal{V} . Then*

$$\sum_{j=1}^N (-1)^{j-1} \Delta(|v\rangle, |v_1\rangle, \dots, \widehat{|v_j\rangle}, \dots, |v_N\rangle) \cdot |v_j\rangle = \Delta(|v_1\rangle, \dots, |v_N\rangle) \cdot |v\rangle$$

where a hat on a vector means that particular vector is missing.

Proof See Problem 2.37. \square

2.6.1 Determinant of a Linear Operator

Let \mathbf{A} be a linear operator on an N -dimensional vector space \mathcal{V} . Choose a nonzero determinant function Δ . For a basis $\{|v_i\rangle\}_{i=1}^N$ define the function $\Delta_{\mathbf{A}}$ by

$$\Delta_{\mathbf{A}}(|v_1\rangle, \dots, |v_N\rangle) \equiv \Delta(\mathbf{A}|v_1\rangle, \dots, \mathbf{A}|v_N\rangle). \quad (2.31)$$

Clearly, Δ_A is also a determinant function. By Corollary 2.6.8, it is a multiple of Δ . So, $\Delta_A = \alpha\Delta$. Furthermore, it is independent of the nonzero determinant function chosen, because if Δ' is another nonzero determinant function, then again by Corollary 2.6.8, $\Delta' = \lambda\Delta$, and

$$\Delta'_A = \lambda\Delta_A = \lambda\alpha\Delta = \alpha\Delta'.$$

determinant of an operator defined This means that α is determined only by \mathbf{A} , independent of the nonzero determinant function and the basis chosen.

Definition 2.6.10 Let $\mathbf{A} \in \text{End}(\mathcal{V})$. Let Δ be a nonzero determinant function in \mathcal{V} , and let Δ_A be as in Eq. (2.31). Then

$$\Delta_A = \det \mathbf{A} \cdot \Delta \tag{2.32}$$

defines the **determinant** of \mathbf{A} .

Using Eq. (2.32), we have the following theorem whose proof is left as Problem 2.38:

Theorem 2.6.11 *The determinant of a linear operator \mathbf{A} has the following properties:*

1. If $\mathbf{A} = \lambda\mathbf{1}$, then $\det \mathbf{A} = \lambda^N$.
2. \mathbf{A} is invertible iff $\det \mathbf{A} \neq 0$.
3. $\det(\mathbf{A} \circ \mathbf{B}) = \det \mathbf{A} \det \mathbf{B}$.

2.6.2 Classical Adjoint

Let \mathcal{V} be an N -dimensional vector space, Δ a determinant function in \mathcal{V} , and $\mathbf{A} \in \text{End}(\mathcal{V})$. For $|v\rangle, |v_i\rangle \in \mathcal{V}$, define $\Phi : \mathcal{V}^N \rightarrow \text{End}(\mathcal{V})$ by

$$\begin{aligned} \Phi(|v_1\rangle, \dots, |v_N\rangle)|v\rangle \\ = \sum_{j=1}^N (-1)^{j-1} \Delta(|v\rangle, \mathbf{A}|v_1\rangle, \dots, \widehat{\mathbf{A}|v_j\rangle}, \dots, \mathbf{A}|v_N\rangle) \cdot |v_j\rangle. \end{aligned}$$

Clearly Φ is skew-symmetric. Therefore, by Proposition 2.6.7, there is a unique linear operator—call it $\text{ad}(\mathbf{A})$ —such that

$$\Phi(|v_1\rangle, \dots, |v_N\rangle) = \Delta(|v_1\rangle, \dots, |v_N\rangle) \cdot \text{ad}(\mathbf{A}),$$

i.e.,

$$\begin{aligned} \sum_{j=1}^N (-1)^{j-1} \Delta(|v\rangle, \mathbf{A}|v_1\rangle, \dots, \widehat{\mathbf{A}|v_j\rangle}, \dots, \mathbf{A}|v_N\rangle) \cdot |v_j\rangle \\ = \Delta(|v_1\rangle, \dots, |v_N\rangle) \cdot \text{ad}(\mathbf{A})|v\rangle. \end{aligned} \tag{2.33}$$

This equation shows that $\text{ad}(\mathbf{A})$ is independent of the determinant function chosen, and is called the **classical adjoint** of \mathbf{A} . classical adjoint of an operator

Proposition 2.6.12 *The classical adjoint satisfies the following relations:*

$$\text{ad}(\mathbf{A}) \circ \mathbf{A} = \det \mathbf{A} \cdot \mathbf{1} = \mathbf{A} \circ \text{ad}(\mathbf{A}) \quad (2.34)$$

where $\mathbf{1}$ is the unit operator.

Proof Replace $|v\rangle$ with $\mathbf{A}|v\rangle$ in Eq. (2.33) to obtain

$$\begin{aligned} & \sum_{j=1}^N (-1)^{j-1} \Delta(\mathbf{A}|v\rangle, \mathbf{A}|v_1\rangle, \dots, \widehat{\mathbf{A}|v_j\rangle}, \dots, \mathbf{A}|v_N\rangle) \cdot |v_j\rangle \\ &= \Delta(|v_1\rangle, \dots, |v_N\rangle) \text{ad}(\mathbf{A}) \circ \mathbf{A}|v\rangle. \end{aligned}$$

Then, the left-hand side can be written as

$$\begin{aligned} \text{LHS} &= \det \mathbf{A} \cdot \sum_{j=1}^N (-1)^{j-1} \Delta(|v\rangle, |v_1\rangle, \dots, \widehat{|v_j\rangle}, \dots, |v_N\rangle) \cdot |v_j\rangle \\ &= \det \mathbf{A} \cdot \Delta(|v_1\rangle, \dots, |v_N\rangle) \cdot |v\rangle, \end{aligned}$$

where the last equality follows from Proposition 2.6.9. Noting that $|v\rangle$ is arbitrary, the first equality of the proposition follows.

To obtain the second equality, apply \mathbf{A} to (2.33). Then by Proposition 2.6.9, the left-hand side becomes

$$\begin{aligned} \text{LHS} &= \sum_{j=1}^N (-1)^{j-1} \Delta(|v\rangle, \mathbf{A}|v_1\rangle, \dots, \widehat{\mathbf{A}|v_j\rangle}, \dots, \mathbf{A}|v_N\rangle) \cdot \mathbf{A}|v_j\rangle \\ &= \Delta(\mathbf{A}|v_1\rangle, \dots, \mathbf{A}|v_N\rangle) \cdot |v\rangle = \det \mathbf{A} \cdot \Delta(|v_1\rangle, \dots, |v_N\rangle) \cdot |v\rangle, \end{aligned}$$

and the right-hand side becomes

$$\text{RHS} = \Delta(|v_1\rangle, \dots, |v_N\rangle) \cdot \mathbf{A} \circ \text{ad}(\mathbf{A})|v\rangle.$$

Since the two sides hold for arbitrary $|v\rangle$, the second equality of the proposition follows. \square

Corollary 2.6.13 *If $\det \mathbf{A} \neq 0$, then \mathbf{A} is invertible and*

$$\mathbf{A}^{-1} = \frac{1}{\det \mathbf{A}} \cdot \text{ad}(\mathbf{A}).$$

2.7 Problems

2.1 Let \mathbb{R}^+ denote the set of positive real numbers. Define the “sum” of two elements of \mathbb{R}^+ to be their usual product, and define scalar multiplication by elements of \mathbb{R} as being given by $r \cdot p = p^r$ where $r \in \mathbb{R}$ and $p \in \mathbb{R}^+$. With these operations, show that \mathbb{R}^+ is a vector space over \mathbb{R} .

2.2 Show that the intersection of two subspaces is also a subspace.

2.3 For each of the following subsets of \mathbb{R}^3 determine whether it is a subspace of \mathbb{R}^3 :

- (a) $\{(x, y, z) \in \mathbb{R}^3 \mid x + y - 2z = 0\}$;
 (b) $\{(x, y, z) \in \mathbb{R}^3 \mid x + y - 2z = 3\}$;
 (c) $\{(x, y, z) \in \mathbb{R}^3 \mid xyz = 0\}$.

2.4 Prove that the components of a vector in a given basis are unique.

2.5 Show that the following vectors form a basis for \mathbb{C}^n (or \mathbb{R}^n).

$$|a_1\rangle = \begin{pmatrix} 1 \\ 1 \\ \vdots \\ 1 \\ 1 \end{pmatrix}, \quad |a_2\rangle = \begin{pmatrix} 1 \\ 1 \\ \vdots \\ 1 \\ 0 \end{pmatrix}, \quad \dots, \quad |a_n\rangle = \begin{pmatrix} 1 \\ 0 \\ \vdots \\ 0 \\ 0 \end{pmatrix}.$$

2.6 Prove Theorem 2.1.6.

2.7 Let \mathcal{W} be a subspace of \mathbb{R}^5 defined by

$$\mathcal{W} = \{(x_1, \dots, x_5) \in \mathbb{R}^5 \mid x_1 = 3x_2 + x_3, x_2 = x_5, \text{ and } x_4 = 2x_3\}.$$

Find a basis for \mathcal{W} .

2.8 Let \mathcal{U}_1 and \mathcal{U}_2 be subspaces of \mathcal{V} . Show that

- (a) $\dim(\mathcal{U}_1 + \mathcal{U}_2) = \dim \mathcal{U}_1 + \dim \mathcal{U}_2 - \dim(\mathcal{U}_1 \cap \mathcal{U}_2)$. Hint: Let $\{|a_i\rangle\}_{i=1}^m$ be a basis of $\mathcal{U}_1 \cap \mathcal{U}_2$. Extend this to $\{|a_i\rangle\}_{i=1}^m, \{|b_i\rangle\}_{i=1}^k\}$, a basis for \mathcal{U}_1 , and to $\{|a_i\rangle\}_{i=1}^m, \{|c_i\rangle\}_{i=1}^l\}$, a basis for \mathcal{U}_2 . Now show that $\{|a_i\rangle\}_{i=1}^m, \{|b_i\rangle\}_{i=1}^k, \{|c_i\rangle\}_{i=1}^l\}$ is a basis for $\mathcal{U}_1 + \mathcal{U}_2$.
 (b) If $\mathcal{U}_1 + \mathcal{U}_2 = \mathcal{V}$ and $\dim \mathcal{U}_1 + \dim \mathcal{U}_2 = \dim \mathcal{V}$, then $\mathcal{V} = \mathcal{U}_1 \oplus \mathcal{U}_2$.
 (c) If $\dim \mathcal{U}_1 + \dim \mathcal{U}_2 > \dim \mathcal{V}$, then $\mathcal{U}_1 \cap \mathcal{U}_2 \neq \{0\}$.

2.9 Show that the vectors defined in Eq. (2.5) span $\mathcal{W} = \mathcal{U} \oplus \mathcal{V}$.

2.10 Show that the inner product of any vector with $|0\rangle$ is zero.

2.11 Find a_0, b_0, b_1, c_0, c_1 , and c_2 such that the polynomials $a_0, b_0 + b_1 t$, and $c_0 + c_1 t + c_2 t^2$ are mutually orthonormal in the interval $[0, 1]$. The inner product is as defined for polynomials in Example 2.2.3 with $w(t) = 1$.

2.12 Given the linearly independent vectors $x(t) = t^n$, for $n = 0, 1, 2, \dots$ in $\mathcal{P}^c[t]$, use the Gram–Schmidt process to find the orthonormal polynomials $e_0(t), e_1(t)$, and $e_2(t)$

- (a) when the inner product is defined as $\langle x|y\rangle = \int_{-1}^1 x^*(t)y(t) dt$.

(b) when the inner product is defined with a nontrivial weight function:

$$\langle x|y \rangle = \int_{-\infty}^{\infty} e^{-t^2} x^*(t)y(t) dt.$$

Hint: Use the following result:

$$\int_{-\infty}^{\infty} e^{-t^2} t^n dt = \begin{cases} \sqrt{\pi} & \text{if } n = 0, \\ 0 & \text{if } n \text{ is odd,} \\ \sqrt{\pi} \frac{1 \cdot 3 \cdot 5 \cdots (n-1)}{2^{n/2}} & \text{if } n \text{ is even.} \end{cases}$$

2.13 (a) Use the Gram–Schmidt process to find an orthonormal set of vectors out of $(1, -1, 1)$, $(-1, 0, 1)$, and $(2, -1, 2)$.

(b) Are these three vectors linearly independent? If not, find a zero linear combination of them by using part (a).

2.14 (a) Use the Gram–Schmidt process to find an orthonormal set of vectors out of $(1, -1, 2)$, $(-2, 1, -1)$, and $(-1, -1, 4)$.

(b) Are these three vectors linearly independent? If not, find a zero linear combination of them by using part (a).

2.15 Show that

$$\begin{aligned} & \int_{-\infty}^{\infty} (t^{10} - t^6 + 5t^4 - 5)e^{-t^4} dt \\ & \leq \sqrt{\int_{-\infty}^{\infty} (t^4 - 1)^2 e^{-t^4} dt} \sqrt{\int_{-\infty}^{\infty} (t^6 + 5)^2 e^{-t^4} dt}. \end{aligned}$$

Hint: Define an appropriate inner product and use the Schwarz inequality.

2.16 Show that

$$\begin{aligned} & \int_{-\infty}^{\infty} dx \int_{-\infty}^{\infty} dy (x^5 - x^3 + 2x^2 - 2)(y^5 - y^3 + 2y^2 - 2)e^{-(x^4+y^4)} \\ & \leq \int_{-\infty}^{\infty} dx \int_{-\infty}^{\infty} dy (x^4 - 2x^2 + 1)(y^6 + 4y^3 + 4)e^{-(x^4+y^4)}. \end{aligned}$$

Hint: Define an appropriate inner product and use the Schwarz inequality.

2.17 Show that for any set of n complex numbers $\alpha_1, \alpha_2, \dots, \alpha_n$, we have

$$|\alpha_1 + \alpha_2 + \cdots + \alpha_n|^2 \leq n(|\alpha_1|^2 + |\alpha_2|^2 + \cdots + |\alpha_n|^2).$$

Hint: Apply the Schwarz inequality to $(1, 1, \dots, 1)$ and $(\alpha_1, \alpha_2, \dots, \alpha_n)$.

2.18 Using the Schwarz inequality show that if $\{\alpha_i\}_{i=1}^{\infty}$ and $\{\beta_i\}_{i=1}^{\infty}$ are in \mathbb{C}^{∞} , then $\sum_{i=1}^{\infty} \alpha_i^* \beta_i$ is convergent.

2.19 Show that $\mathbf{T} : \mathbb{R}^2 \rightarrow \mathbb{R}^3$ given by $\mathbf{T}(x, y) = (x^2 + y^2, x + y, 2x - y)$ is not a linear mapping.

2.20 Verify that all the transformations of Example 2.3.5 are linear.

2.21 Let π be the permutation that takes $(1, 2, 3)$ to $(3, 1, 2)$. Find

$$\mathbf{A}_\pi |e_i\rangle, \quad i = 1, 2, 3,$$

where $\{|e_i\rangle\}_{i=1}^3$ is the standard basis of \mathbb{R}^3 (or \mathbb{C}^3), and \mathbf{A}_π is as defined in Example 2.3.5.

2.22 Show that if $\mathbf{T} \in \mathcal{L}(\mathbb{C}, \mathbb{C})$, then there exists $\alpha \in \mathbb{C}$ such that $\mathbf{T}|a\rangle = \alpha|a\rangle$ for all $|a\rangle \in \mathbb{C}$.

2.23 Show that if $\{|a_i\rangle\}_{i=1}^n$ spans \mathcal{V} and $\mathbf{T} \in \mathcal{L}(\mathcal{V}, \mathcal{W})$, then $\{\mathbf{T}|a_i\rangle\}_{i=1}^n$ spans $\mathbf{T}(\mathcal{V})$. In particular, if \mathbf{T} is surjective, then $\{\mathbf{T}|a_i\rangle\}_{i=1}^n$ spans \mathcal{W} .

2.24 Give an example of a function $f: \mathbb{R}^2 \rightarrow \mathbb{R}$ such that

$$f(\alpha|a\rangle) = \alpha f(|a\rangle) \quad \forall \alpha \in \mathbb{R} \text{ and } |a\rangle \in \mathbb{R}^2$$

but f is not linear. Hint: Consider a homogeneous function of degree 1.

2.25 Show that the following transformations are linear:

- (a) \mathcal{V} is \mathbb{C} over the reals and $\mathbf{C}|z\rangle = |z^*\rangle$. Is \mathbf{C} linear if instead of real numbers, complex numbers are used as scalars?
- (b) \mathcal{V} is $\mathcal{P}^c[t]$ and $\mathbf{T}|x(t)\rangle = |x(t+1)\rangle - |x(t)\rangle$.

2.26 Verify that the kernel of a transformation $\mathbf{T}: \mathcal{V} \rightarrow \mathcal{W}$ is a subspace of \mathcal{V} , and that $\mathbf{T}(\mathcal{V})$ is a subspace of \mathcal{W} .

2.27 Let \mathcal{V} and \mathcal{W} be finite dimensional vector spaces. Show that if $\mathbf{T} \in \mathcal{L}(\mathcal{V}, \mathcal{W})$ is surjective, then $\dim W \leq \dim V$.

2.28 Suppose that \mathcal{V} is finite dimensional and $\mathbf{T} \in \mathcal{L}(\mathcal{V}, \mathcal{W})$ is not zero. Prove that there exists a subspace \mathcal{U} of \mathcal{V} such that $\ker \mathbf{T} \cap \mathcal{U} = \{0\}$ and $\mathbf{T}(\mathcal{V}) = \mathbf{T}(\mathcal{U})$.

2.29 Using Theorem 2.3.11, prove Theorem 2.3.18.

2.30 Using Theorem 2.3.11, prove Theorem 2.3.19.

2.31 Let $B_V = \{|a_i\rangle\}_{i=1}^N$ be a basis for \mathcal{V} and $B_W = \{|b_i\rangle\}_{i=1}^N$ a basis for \mathcal{W} . Define the linear transformation $\mathbf{T}|a_i\rangle = |b_i\rangle$, $i = 1, 2, \dots, N$. Now prove Theorem 2.3.20 by showing that \mathbf{T} is an isomorphism.

2.32 Show that $(\mathbf{A}^T)^T = \mathbf{A}$ for the adjoint given in Definition 2.4.3.

2.33 Show that \mathcal{W}^0 is a subspace of \mathcal{V}^* and

$$\dim \mathcal{V} = \dim \mathcal{W} + \dim \mathcal{W}^0.$$

2.34 Show that every vector in the N -dimensional vector space \mathcal{V}^* has $N - 1$ linearly independent annihilators. Stated differently, show that a linear functional maps $N - 1$ linearly independent vectors to zero.

2.35 Show that \mathbf{T} and \mathbf{T}^* have the same rank. In particular, show that if \mathbf{T} is injective, then \mathbf{T}^* is surjective. Hint: Use the dimension theorem for \mathbf{T} and \mathbf{T}^* and Eq. (2.25).

2.36 Prove Theorem 2.6.3.

2.37 Prove Proposition 2.6.9. Hint: First show that you get zero on both sides if $\{|v_k\rangle\}_{k=1}^N$ are linearly dependent. Next assume their linear independence and choose them as a basis, write $|v\rangle$ in terms of them, and note that

$$\Delta(|v\rangle, |v_1\rangle, \dots, \widehat{|v_j\rangle}, \dots, |v_N\rangle) = 0$$

unless $i = j$.

2.38 Prove Theorem 2.6.11. Hint: For the second part of the theorem, use the fact that an invertible \mathbf{A} maps linearly independent sets of vectors onto linearly independent sets.

In many physical applications, a vector space \mathcal{V} has a natural “product”, i.e., a binary operation $\mathcal{V} \times \mathcal{V} \rightarrow \mathcal{V}$, which we call multiplication. The prime example of such a vector space is the vector space of matrices. It is therefore useful to consider vector spaces for which such a product exists.

3.1 From Vector Space to Algebra

In this section, we define an algebra, give some familiar examples of algebras, and discuss some of their basic properties.

Definition 3.1.1 An **algebra** \mathcal{A} over \mathbb{C} (or \mathbb{R}) is a vector space over \mathbb{C} (or \mathbb{R}), together with a binary operation $\mathcal{A} \times \mathcal{A} \rightarrow \mathcal{A}$, called **multiplication**. The image of $(\mathbf{a}, \mathbf{b}) \in \mathcal{A} \times \mathcal{A}$ under this mapping¹ is denoted by \mathbf{ab} , and it satisfies the following two relations

algebra defined

$$\mathbf{a}(\beta\mathbf{b} + \gamma\mathbf{c}) = \beta\mathbf{ab} + \gamma\mathbf{ac}$$

$$(\beta\mathbf{b} + \gamma\mathbf{c})\mathbf{a} = \beta\mathbf{ba} + \gamma\mathbf{ca}$$

for all $\mathbf{a}, \mathbf{b}, \mathbf{c} \in \mathcal{A}$ and $\beta, \gamma \in \mathbb{C}$ (or \mathbb{R}). The dimension of the vector space is called the **dimension of the algebra**. The algebra is called **associative** if the product satisfies $\mathbf{a}(\mathbf{bc}) = (\mathbf{ab})\mathbf{c}$ and **commutative** if it satisfies $\mathbf{ab} = \mathbf{ba}$. An algebra with **identity** is an algebra that has an element $\mathbf{1}$ satisfying $\mathbf{a1} = \mathbf{1a} = \mathbf{a}$. An element \mathbf{b} of an algebra with identity is said to be a **left inverse** of \mathbf{a} if $\mathbf{ba} = \mathbf{1}$. **Right inverse** is defined similarly. The identity is also called **unit**, and an algebra with identity is also called a **unital algebra**.

dimension of the algebra; associativity; commutativity; identity; and right and left inverses

It is sometimes necessary to use a different notation for the identity of an algebra. This happens especially when we are discussing several algebras at the same time. A common notation other than $\mathbf{1}$ is \mathbf{e} .

¹We shall, for the most part, abandon the Dirac bra-and-ket notation in this chapter due to its clumsiness; instead we use boldface roman letters to denote vectors.

3.1.1 General Properties

Taking $\beta = 1 = -\gamma$ and $\mathbf{b} = \mathbf{c}$ in the definition above leads immediately to

$$\mathbf{a}\mathbf{0} = \mathbf{0}\mathbf{a} = \mathbf{0} \quad \forall \mathbf{a} \in \mathcal{A}.$$

The identity of an algebra is unique. If there were two identities $\mathbf{1}$ and \mathbf{e} , then $\mathbf{1}\mathbf{e} = \mathbf{e}$, because $\mathbf{1}$ is the identity, and $\mathbf{1}\mathbf{e} = \mathbf{1}$, because \mathbf{e} is the identity.

If \mathcal{A} is an associative algebra and $\mathbf{a} \in \mathcal{A}$ has both a left inverse \mathbf{b} and a right inverse \mathbf{c} , then the two are equal:

$$\mathbf{bac} = (\mathbf{ba})\mathbf{c} = \mathbf{1c} = \mathbf{c},$$

$$\mathbf{bac} = \mathbf{b(ac)} = \mathbf{b1} = \mathbf{b}.$$

Therefore, in an associative algebra, we talk of an inverse without specifying right or left. Furthermore, it is trivial to show that the (two-sided) inverse is unique. Hence, we have

Theorem 3.1.2 *Let \mathcal{A} be an associative algebra with identity. If $\mathbf{a} \in \mathcal{A}$ has a right and a left inverse, then they are equal and this single inverse is unique. We denote it by \mathbf{a}^{-1} . If \mathbf{a} and \mathbf{b} are invertible, then \mathbf{ab} is also invertible, and*

$$(\mathbf{ab})^{-1} = \mathbf{b}^{-1}\mathbf{a}^{-1}.$$

The proof of the last statement is straightforward.

subalgebra of an algebra

Definition 3.1.3 Let \mathcal{A} be an algebra and \mathcal{A}' a linear subspace of \mathcal{A} . If \mathcal{A}' is closed under multiplication, i.e., if $\mathbf{ab} \in \mathcal{A}'$ whenever $\mathbf{a} \in \mathcal{A}'$ and $\mathbf{b} \in \mathcal{A}'$, then \mathcal{A}' is called a **subalgebra** of \mathcal{A} .

Clearly, a subalgebra of an associative (commutative) algebra is also associative (commutative).

subalgebra generated by a subset

Let \mathcal{A} be an associative algebra and S a subset of \mathcal{A} . The **subalgebra generated by S** is the collection of all linear combinations of

$$\mathbf{s}_1\mathbf{s}_2 \dots \mathbf{s}_k, \quad \mathbf{s}_i \in S.$$

If S consists of a single element \mathbf{s} , then the subalgebra generated by \mathbf{s} is the set of polynomials in \mathbf{s} .

\mathbb{C} is a subalgebra of any unital algebra.

Example 3.1.4 Let \mathcal{A} be a unital algebra, then the vector space

$$\text{Span}\{\mathbf{1}\} = \{\alpha\mathbf{1} \mid \alpha \in \mathbb{C}\}$$

is a subalgebra of \mathcal{A} . Since $\text{Span}\{\mathbf{1}\}$ is indistinguishable from \mathbb{C} , we sometimes say that \mathbb{C} is a subalgebra of \mathcal{A} .

center of an algebra

Definition 3.1.5 Let \mathcal{A} be an algebra. The set of elements of \mathcal{A} which commute with all elements of \mathcal{A} is called the **center** of \mathcal{A} and denoted by $\mathcal{Z}(\mathcal{A})$.

Table 3.1 The multiplication table for \mathcal{S}

| | \mathbf{e}_0 | \mathbf{e}_1 | \mathbf{e}_2 | \mathbf{e}_3 |
|----------------|----------------|-----------------|-----------------|----------------|
| \mathbf{e}_0 | \mathbf{e}_0 | \mathbf{e}_1 | \mathbf{e}_2 | \mathbf{e}_3 |
| \mathbf{e}_1 | \mathbf{e}_1 | \mathbf{e}_0 | \mathbf{e}_3 | \mathbf{e}_2 |
| \mathbf{e}_2 | \mathbf{e}_2 | $-\mathbf{e}_3$ | $-\mathbf{e}_0$ | \mathbf{e}_1 |
| \mathbf{e}_3 | \mathbf{e}_3 | $-\mathbf{e}_2$ | $-\mathbf{e}_1$ | \mathbf{e}_0 |

$\mathcal{Z}(\mathcal{A})$ is easily shown to be a subspace of \mathcal{A} , and if \mathcal{A} is associative, then $\mathcal{Z}(\mathcal{A})$ is a subalgebra of \mathcal{A} .

Definition 3.1.6 A unital algebra \mathcal{A} is called **central** if $\mathcal{Z}(\mathcal{A}) = \text{Span}\{\mathbf{1}\}$. central algebra

Example 3.1.7 Consider the algebra \mathcal{S} with basis $\{\mathbf{e}_i\}_{i=0}^3$ and multiplication table given in Table 3.1, where for purely aesthetic reasons the identity has been denoted by \mathbf{e}_0 .

We want to see which elements belong to the center. Let $\mathbf{a} \in \mathcal{Z}(\mathcal{S})$. Then for any arbitrary element $\mathbf{b} \in \mathcal{S}$, we must have $\mathbf{ab} = \mathbf{ba}$. Let

$$\mathbf{a} = \sum_{i=0}^3 \alpha_i \mathbf{e}_i \quad \text{and} \quad \mathbf{b} = \sum_{i=0}^3 \beta_i \mathbf{e}_i.$$

Then a straightforward calculation shows that

$$\begin{aligned} \mathbf{ab} &= (\alpha_0\beta_0 + \alpha_1\beta_1 - \alpha_2\beta_2 + \alpha_3\beta_3)\mathbf{e}_0 \\ &\quad + (\alpha_0\beta_1 + \alpha_1\beta_0 + \alpha_2\beta_3 - \alpha_3\beta_2)\mathbf{e}_1 \\ &\quad + (\alpha_0\beta_2 + \alpha_1\beta_3 + \alpha_2\beta_0 - \alpha_3\beta_1)\mathbf{e}_2 \\ &\quad + (\alpha_0\beta_3 + \alpha_1\beta_2 - \alpha_2\beta_1 + \alpha_3\beta_0)\mathbf{e}_3, \end{aligned}$$

with a similar expression for \mathbf{ba} , in which α s and β s are switched. It is easy to show that the two expressions are equal if and only if

$$\alpha_2\beta_3 = \alpha_3\beta_2 \quad \text{and} \quad \alpha_1\beta_3 = \alpha_3\beta_1.$$

This can hold for arbitrary \mathbf{b} only if $\alpha_1 = \alpha_2 = \alpha_3 = 0$, with α_0 arbitrary. Therefore, $\mathbf{a} \in \mathcal{Z}(\mathcal{S})$ if and only if \mathbf{a} is a multiple of \mathbf{e}_0 , i.e., if and only if $\mathbf{a} \in \text{Span}\{\mathbf{e}_0\}$. Therefore, \mathcal{S} is central.

Let A and B be subsets of an algebra \mathcal{A} . We denote by AB the set of elements in \mathcal{A} which can be written as the sum of products of an element in A by an element in B :

$$AB \equiv \left\{ \mathbf{x} \in \mathcal{A} \mid \mathbf{x} = \sum_k \mathbf{a}_k \mathbf{b}_k, \mathbf{a}_k \in A, \mathbf{b}_k \in B \right\}. \quad (3.1)$$

In particular,

$$\mathcal{A}^2 \equiv \left\{ \mathbf{x} \in \mathcal{A} \mid \mathbf{x} = \sum_k \mathbf{a}_k \mathbf{b}_k, \mathbf{a}_k, \mathbf{b}_k \in \mathcal{A} \right\} \quad (3.2)$$

derived algebra is called the **derived algebra** of \mathcal{A} .

Algebra **opposite to** \mathcal{A} **Definition 3.1.8** Given any algebra \mathcal{A} , in which $(\mathbf{a}, \mathbf{b}) \mapsto \mathbf{ab}$, we can obtain a second algebra \mathcal{A}^{op} in which $(\mathbf{a}, \mathbf{b}) \mapsto \mathbf{ba}$. We write

$$(\mathbf{ab})^{\text{op}} = \mathbf{ba}$$

and call \mathcal{A}^{op} the algebra **opposite to** \mathcal{A} .

It is obvious that if \mathcal{A} is associative, so is \mathcal{A}^{op} , and if \mathcal{A} is commutative, then $\mathcal{A}^{\text{op}} = \mathcal{A}$.

Example 3.1.9 Here are some examples of algebra:

- Define the following product on \mathbb{R}^2 :

$$(x_1, x_2)(y_1, y_2) = (x_1y_1 - x_2y_2, x_1y_2 + x_2y_1).$$

The reader is urged to verify that this product turns \mathbb{R}^2 into a commutative algebra.

- Similarly, the vector (cross) product on \mathbb{R}^3 turns it into a nonassociative, noncommutative algebra.
- The paradigm of all algebras is the **matrix algebra** whose binary operation is ordinary multiplication of $n \times n$ matrices. This algebra is associative but not commutative.
- Let \mathcal{A} be the set of $n \times n$ matrices. Define the binary operation, denoted by \bullet , as

$$\mathbf{A} \bullet \mathbf{B} \equiv \mathbf{AB} - \mathbf{BA}, \quad (3.3)$$

where the RHS is ordinary matrix multiplication. The reader may check that \mathcal{A} together with this operation becomes a nonassociative, noncommutative algebra.

- Let \mathcal{A} be the set of $n \times n$ upper triangular matrices, i.e., matrices all of whose elements below the diagonal are zero. With ordinary matrix multiplication, this set turns into an associative, noncommutative algebra, as the reader can verify.
- Let \mathcal{A} be the set of $n \times n$ upper triangular matrices. Define the binary operation as in Eq. (3.3). The reader may check that \mathcal{A} together with this operation becomes a nonassociative, noncommutative algebra. The derived algebra \mathcal{A}^2 of \mathcal{A} is the set of $n \times n$ *strictly upper triangular matrices*, i.e., upper triangular matrices whose diagonal elements are all zero.
- We have already established that the set of linear transformations $L(\mathcal{V}, \mathcal{W})$ from \mathcal{V} to \mathcal{W} is a vector space. Let us attempt to define a multiplication as well. The best candidate is the composition of linear transformations. If $\mathbf{T} : \mathcal{V} \rightarrow \mathcal{U}$ and $\mathbf{S} : \mathcal{U} \rightarrow \mathcal{W}$ are linear operators, then the composition $\mathbf{S} \circ \mathbf{T} : \mathcal{V} \rightarrow \mathcal{W}$ is also a linear operator, as can easily be verified. This product, however, is not defined on a single vector space, but is such that it takes an element in $L(\mathcal{V}, \mathcal{U})$ and another element in

a second vector space $L(\mathcal{U}, \mathcal{W})$ to give an element in yet another vector space $L(\mathcal{V}, \mathcal{W})$. An algebra requires a single vector space. We can accomplish this by letting $\mathcal{V} = \mathcal{U} = \mathcal{W}$. Then the three spaces of linear transformations collapse to the single space $L(\mathcal{V}, \mathcal{V})$, the set of endomorphisms of \mathcal{V} , which we have abbreviated as $\mathcal{L}(\mathcal{V})$ or $\text{End}(\mathcal{V})$ and to which $\mathbf{T}, \mathbf{S}, \mathbf{ST} \equiv \mathbf{S} \circ \mathbf{T}$, and $\mathbf{TS} \equiv \mathbf{T} \circ \mathbf{S}$ belong.

- All the examples above are finite-dimensional algebras. An example of an infinite-dimensional algebra is $\mathcal{C}^r(a, b)$, the vector space of real-valued functions defined on a real interval (a, b) , which have derivatives up to order r . The multiplication is defined pointwise: If $f \in \mathcal{C}^r(a, b)$ and $g \in \mathcal{C}^r(a, b)$, then

$$(fg)(t) \equiv f(t)g(t) \quad \forall t \in (a, b).$$

This algebra is commutative and associative, and has the identity element $f(t) = 1$.

- Another example of an infinite dimensional algebra is the algebra of polynomials.² This algebra is a commutative and associative algebra with identity.

Definition 3.1.10 Let \mathcal{A} and \mathcal{B} be algebras. Then the *vector* direct sum $\mathcal{A} \oplus \mathcal{B}$ becomes an **algebra direct sum** if we define the following product

$$(\mathbf{a}_1 \oplus \mathbf{b}_1)(\mathbf{a}_2 \oplus \mathbf{b}_2) = (\mathbf{a}_1 \mathbf{a}_2 \oplus \mathbf{b}_1 \mathbf{b}_2)$$

algebra direct sum

on $\mathcal{A} \oplus \mathcal{B}$.

Note that if an element \mathbf{a} is in \mathcal{A} , then it can be represented by $\mathbf{a} \oplus \mathbf{0}$ as an element of $\mathcal{A} \oplus \mathcal{B}$. Similarly, an element \mathbf{b} in \mathcal{B} can be represented by $\mathbf{0} \oplus \mathbf{b}$. Thus the product of any element in \mathcal{A} with any element in \mathcal{B} is zero, i.e., $\mathcal{A}\mathcal{B} = \mathcal{B}\mathcal{A} = \{\mathbf{0}\}$. As we shall see later, this condition becomes necessary if a given algebra is to be the direct sum of its subalgebras.

In order for $\mathbf{a} \oplus \mathbf{b}$ to be in the center of $\mathcal{A} \oplus \mathcal{B}$, we must have

$$(\mathbf{a} \oplus \mathbf{b})(\mathbf{x} \oplus \mathbf{y}) = (\mathbf{x} \oplus \mathbf{y})(\mathbf{a} \oplus \mathbf{b}),$$

or

$$\mathbf{ax} \oplus \mathbf{by} = \mathbf{xa} \oplus \mathbf{yb} \quad \text{or} \quad (\mathbf{ax} - \mathbf{xa}) \oplus (\mathbf{by} - \mathbf{yb}) = \mathbf{0},$$

for all $\mathbf{x} \in \mathcal{A}$ and $\mathbf{y} \in \mathcal{B}$. For this to hold, we must have

$$\mathbf{ax} - \mathbf{xa} = \mathbf{0} \quad \text{and} \quad \mathbf{by} - \mathbf{yb} = \mathbf{0},$$

i.e., that $\mathbf{a} \in \mathcal{Z}(\mathcal{A})$ and $\mathbf{b} \in \mathcal{Z}(\mathcal{B})$. Hence,

$$\mathcal{Z}(\mathcal{A} \oplus \mathcal{B}) = \mathcal{Z}(\mathcal{A}) \oplus \mathcal{Z}(\mathcal{B}). \tag{3.4}$$

Definition 3.1.11 Let \mathcal{A} and \mathcal{B} be algebras. Then the vector space tensor algebra tensor product

²It should be clear that the algebra of polynomials cannot be finite dimensional.

product $\mathcal{A} \otimes \mathcal{B}$ becomes an **algebra tensor product** if we define the product

$$(\mathbf{a}_1 \otimes \mathbf{b}_1)(\mathbf{a}_2 \otimes \mathbf{b}_2) = \mathbf{a}_1 \mathbf{a}_2 \otimes \mathbf{b}_1 \mathbf{b}_2$$

on $\mathcal{A} \otimes \mathcal{B}$. Because of the isomorphism, $\mathcal{A} \otimes \mathcal{B} \cong \mathcal{B} \otimes \mathcal{A}$, we demand that $\mathbf{a} \otimes \mathbf{b} = \mathbf{b} \otimes \mathbf{a}$ for all $\mathbf{a} \in \mathcal{A}$ and $\mathbf{b} \in \mathcal{B}$.

The last condition of the definition becomes an important requirement when we write a given algebra \mathcal{A} as the tensor product of two of its subalgebras \mathcal{B} and \mathcal{C} . In such a case, \otimes coincides with the multiplication in \mathcal{A} , and the condition becomes the requirement that all elements of \mathcal{B} commute with all elements of \mathcal{C} , i.e., $\mathcal{B}\mathcal{C} = \mathcal{C}\mathcal{B}$.

Definition 3.1.12 Given an algebra \mathcal{A} and a basis $B = \{\mathbf{e}_i\}_{i=1}^N$ for the underlying vector space, one can write

structure constants of an algebra

$$\mathbf{e}_i \mathbf{e}_j = \sum_{k=1}^N c_{ij}^k \mathbf{e}_k, \quad c_{ij}^k \in \mathbb{C}. \quad (3.5)$$

The complex numbers c_{ij}^k , the components of the vector $\mathbf{e}_i \mathbf{e}_j$ in the basis B , are called the **structure constants** of \mathcal{A} .

The structure constants determine the product of any two vectors once they are expressed in terms of the basis vectors of B . Conversely, given any N -dimensional vector space \mathcal{V} , one can turn it into an algebra by choosing a basis and a set of N^3 numbers $\{c_{ij}^k\}$ and defining the product of basis vectors by Eq. (3.5).

Example 3.1.13 Let the structure constants in algebras \mathcal{A} and \mathcal{B} be $\{a_{ij}^k\}_{i,j,k=1}^M$ and $\{b_{mn}^l\}_{l,m,n=1}^N$ in their bases $\{\mathbf{e}_i\}_{i=1}^M$ and $\{\mathbf{f}_n\}_{n=1}^N$, respectively. So that

$$\mathbf{e}_i \mathbf{e}_j = \sum_{k=1}^M a_{ij}^k \mathbf{e}_k \quad \text{and} \quad \mathbf{f}_m \mathbf{f}_n = \sum_{l=1}^N b_{mn}^l \mathbf{f}_l.$$

Construct the MN dimensional algebra \mathcal{C} by defining its structure constants as $c_{im,jn}^{kl} = a_{ij}^k b_{mn}^l$ in a basis $\{\mathbf{v}_{kl}\}_{k,l=1}^{M,N}$, so that

$$\mathbf{v}_{im} \mathbf{v}_{jn} = \sum_{i,j=1}^M \sum_{m,n=1}^N c_{im,jn}^{kl} \mathbf{v}_{kl} = \sum_{i,j=1}^M \sum_{m,n=1}^N a_{ij}^k b_{mn}^l \mathbf{v}_{kl}.$$

This algebra is isomorphic to the algebra $\mathcal{A} \otimes \mathcal{B}$. In fact, if we identify \mathbf{v}_{kl} on the right-hand side as $\mathbf{e}_k \otimes \mathbf{f}_l$, then

$$\begin{aligned} \mathbf{v}_{im} \mathbf{v}_{jn} &= \sum_{i,j=1}^M \sum_{m,n=1}^N c_{im,jn}^{kl} \mathbf{e}_k \otimes \mathbf{f}_l = \sum_{i,j=1}^M \sum_{m,n=1}^N a_{ij}^k b_{mn}^l \mathbf{e}_k \otimes \mathbf{f}_l \\ &= \left(\sum_{i,j=1}^M a_{ij}^k \mathbf{e}_k \right) \otimes \left(\sum_{m,n=1}^N b_{mn}^l \mathbf{f}_l \right) = (\mathbf{e}_i \mathbf{e}_j) \otimes (\mathbf{f}_m \mathbf{f}_n), \end{aligned}$$

which is consistent with $\mathbf{v}_{im} \equiv \mathbf{e}_i \otimes \mathbf{f}_m$ and $\mathbf{v}_{jn} \equiv \mathbf{e}_j \otimes \mathbf{f}_n$, and the rule of multiplication of the tensor product of two algebras.

Definition 3.1.14 A unital algebra all of whose nonzero elements have inverses is called a **division algebra**.

division algebra

Example 3.1.15 Let $\{\mathbf{e}_1, \mathbf{e}_2\}$ be a basis of \mathbb{R}^2 . Let the structure constants be

$$\begin{aligned} c_{11}^1 &= -c_{22}^1 = c_{12}^2 = c_{21}^2 = 1 \\ c_{12}^1 &= -c_{21}^1 = c_{11}^2 = c_{22}^2 = 0, \end{aligned}$$

i.e., let

$$\mathbf{e}_1^2 = -\mathbf{e}_2^2 = \mathbf{e}_1, \quad \mathbf{e}_1\mathbf{e}_2 = \mathbf{e}_2\mathbf{e}_1 = \mathbf{e}_2.$$

Then, it is easy to prove that the algebra so constructed is just \mathbb{C} . All that needs to be done is to identify \mathbf{e}_1 with 1 and \mathbf{e}_2 with $\sqrt{-1}$. Clearly, \mathbb{C} is a division algebra.

Example 3.1.16 In the standard basis $\{\mathbf{e}_i\}_{i=0}^3$ of \mathbb{R}^4 , choose the structure constants as follows:

$$\begin{aligned} \mathbf{e}_0^2 &= -\mathbf{e}_1^2 = -\mathbf{e}_2^2 = -\mathbf{e}_3^2 = \mathbf{e}_0, \\ \mathbf{e}_0\mathbf{e}_i &= \mathbf{e}_i\mathbf{e}_0 = \mathbf{e}_i \quad \text{for } i = 1, 2, 3, \\ \mathbf{e}_i\mathbf{e}_j &= \sum_{k=1}^3 \epsilon_{ijk}\mathbf{e}_k \quad \text{for } i, j = 1, 2, 3, \quad i \neq j, \end{aligned}$$

where ϵ_{ijk} is completely antisymmetric in all its indices (therefore vanishing if any two of its indices are equal) and $\epsilon_{123} = 1$. The reader may verify that these relations turn \mathbb{R}^4 into an associative, but noncommutative, algebra. This algebra is called the **algebra of quaternions** and denoted by \mathbb{H} . In this context, \mathbf{e}_0 is usually denoted by 1, and \mathbf{e}_1 , \mathbf{e}_2 , and \mathbf{e}_3 by i , j , and k , respectively, and one writes $q = x + iy + jz + kw$ for an element of \mathbb{H} . It then becomes evident that \mathbb{H} is a generalization of \mathbb{C} . In analogy with \mathbb{C} , x is called the **real part** of q , and (y, z, w) the **pure part** of q . Similarly, the **conjugate** of q is $q^* = x - iy - jz - kw$.

algebra of quaternions

It is convenient to write $q = x_0 + \mathbf{x}$, where \mathbf{x} is a three-dimensional vector. Then $q^* = x_0 - \mathbf{x}$. Furthermore, one can show that, with $q = x_0 + \mathbf{x}$ and $p = y_0 + \mathbf{y}$,

$$qp = \underbrace{x_0y_0 - \mathbf{x} \cdot \mathbf{y}}_{\text{real part of } qp} + \underbrace{x_0\mathbf{y} + y_0\mathbf{x} + \mathbf{x} \times \mathbf{y}}_{\text{pure part of } qp}. \tag{3.6}$$

Changing \mathbf{x} to $-\mathbf{x}$ and \mathbf{y} to $-\mathbf{y}$ in the expression above, one gets

$$q^*p^* = x_0y_0 - \mathbf{x} \cdot \mathbf{y} - x_0\mathbf{y} - y_0\mathbf{x} + \mathbf{x} \times \mathbf{y},$$

which is not equal to $(qp)^*$. However, it is easy to show that $(qp)^* = p^*q^*$.

Substituting q^* for p in (3.6), we get $qq^* = x_0^2 + |\mathbf{x}|^2$. The **absolute value** of q , denoted by $|q|$ is—similar to the absolute value of a complex number—given by $|q| = \sqrt{qq^*}$. If $q \neq 0$, then $q^*/(x_0^2 + |\mathbf{x}|^2)$ is the inverse of q . Thus, the algebra of quaternions is a division algebra.

It is not hard to show that

$$q^n = \sum_{k=0}^{\lfloor n/2 \rfloor} (-1)^k \binom{n}{2k} x_0^{n-2k} |\mathbf{x}|^{2k} + \sum_{k=0}^{\lfloor n/2 \rfloor} (-1)^k \binom{n}{2k+1} x_0^{n-2k-1} |\mathbf{x}|^{2k} \mathbf{x}, \quad (3.7)$$

where $\lfloor n \rfloor = n$ if n is even and $\lfloor n \rfloor = n - 1$ if n is odd.

In order for $\mathbf{a} \otimes \mathbf{b}$ to be in the center of $\mathcal{A} \otimes \mathcal{B}$, we must have

$$(\mathbf{a} \otimes \mathbf{b})(\mathbf{x} \otimes \mathbf{y}) = (\mathbf{x} \otimes \mathbf{y})(\mathbf{a} \otimes \mathbf{b}),$$

or

$$\mathbf{a}\mathbf{x} \otimes \mathbf{b}\mathbf{y} = \mathbf{x}\mathbf{a} \otimes \mathbf{y}\mathbf{b}$$

for all $\mathbf{x} \in \mathcal{A}$ and $\mathbf{y} \in \mathcal{B}$. For this to hold, we must have

$$\mathbf{a}\mathbf{x} = \mathbf{x}\mathbf{a} \quad \text{and} \quad \mathbf{b}\mathbf{y} = \mathbf{y}\mathbf{b},$$

i.e., that $\mathbf{a} \in \mathcal{Z}(\mathcal{A})$ and $\mathbf{b} \in \mathcal{Z}(\mathcal{B})$. Hence,

$$\mathcal{Z}(\mathcal{A} \otimes \mathcal{B}) = \overline{\mathcal{Z}(\mathcal{A})} \otimes \mathcal{Z}(\mathcal{B}). \quad (3.8)$$

Generator of an algebra

Let \mathcal{A} be an associative algebra. A subset $S \subset \mathcal{A}$ is called the **generator** of \mathcal{A} if every element of \mathcal{A} can be expressed as a linear combination of the products of elements in S . A basis of the *vector space* \mathcal{A} is clearly a generator of \mathcal{A} . However, it is not the smallest generator, because it may be possible to obtain the entire basis vectors by multiplying a subset of them. For example, (\mathbb{R}^3, \times) , the algebra of vectors under cross product, has the basis $\{\hat{\mathbf{e}}_x, \hat{\mathbf{e}}_y, \hat{\mathbf{e}}_z\}$, but $\{\hat{\mathbf{e}}_x, \hat{\mathbf{e}}_y\}$ —or any other *pair* of unit vectors—is a generator because $\hat{\mathbf{e}}_z = \hat{\mathbf{e}}_x \times \hat{\mathbf{e}}_y$.

3.1.2 Homomorphisms

The linear transformations connecting vector spaces can be modified slightly to accommodate the binary operation of multiplication of the corresponding algebras:

Homomorphism,
monomorphism,
epimorphism, and
isomorphism of algebras

Definition 3.1.17 Let \mathcal{A} and \mathcal{B} be algebras. A linear map³ $\phi : \mathcal{A} \rightarrow \mathcal{B}$ is called an **algebra homomorphism** if $\phi(\mathbf{a}\mathbf{b}) = \phi(\mathbf{a})\phi(\mathbf{b})$. An injective, surjective, or bijective algebra homomorphism is called, respectively, a **monomorphism**, an **epimorphism**, or an **isomorphism**. An isomorphism of an algebra onto itself is called an **automorphism**.

³It is more common to use ϕ, ψ etc. instead of \mathbf{T}, \mathbf{U} , etc. for linear maps of *algebras*.

Example 3.1.18 Let \mathcal{A} be \mathbb{R}^3 , and \mathcal{B} the set of 3×3 matrices of the form

$$\mathbf{A} = \begin{pmatrix} 0 & a_1 & -a_2 \\ -a_1 & 0 & a_3 \\ a_2 & -a_3 & 0 \end{pmatrix}.$$

Then the map $\phi : \mathcal{A} \rightarrow \mathcal{B}$ defined by

$$\phi(\mathbf{a}) = \phi(a_1, a_2, a_3) = \begin{pmatrix} 0 & a_1 & -a_2 \\ -a_1 & 0 & a_3 \\ a_2 & -a_3 & 0 \end{pmatrix}$$

can be shown to be a *linear* isomorphism. Let the cross product be the binary operation on \mathcal{A} , turning it into an algebra. For \mathcal{B} , define the binary operation of Eq. (3.3). The reader may check that, with these operations, ϕ is extended to an *algebra* isomorphism.

Proposition 3.1.19 Let \mathcal{A} and \mathcal{B} be algebras. Let $\{\mathbf{e}_i\}$ be a basis of \mathcal{A} and $\phi : \mathcal{A} \rightarrow \mathcal{B}$ a linear transformation. Then ϕ is an algebra homomorphism if and only if

$$\phi(\mathbf{e}_i \mathbf{e}_j) = \phi(\mathbf{e}_i) \phi(\mathbf{e}_j).$$

Proof If $\mathbf{a} = \sum_i \alpha_i \mathbf{e}_i$ and $\mathbf{b} = \sum_j \beta_j \mathbf{e}_j$, then

$$\begin{aligned} \phi(\mathbf{a}\mathbf{b}) &= \phi\left(\left(\sum_i \alpha_i \mathbf{e}_i\right)\left(\sum_j \beta_j \mathbf{e}_j\right)\right) = \phi\left(\sum_i \alpha_i \sum_j \beta_j \mathbf{e}_i \mathbf{e}_j\right) \\ &= \sum_i \alpha_i \sum_j \beta_j \phi(\mathbf{e}_i \mathbf{e}_j) = \sum_i \alpha_i \sum_j \beta_j \phi(\mathbf{e}_i) \phi(\mathbf{e}_j) \\ &= \sum_i \alpha_i \phi(\mathbf{e}_i) \sum_j \beta_j \phi(\mathbf{e}_j) = \phi\left(\sum_i \alpha_i \mathbf{e}_i\right) \phi\left(\sum_j \beta_j \mathbf{e}_j\right) \\ &= \phi(\mathbf{a}) \phi(\mathbf{b}). \end{aligned}$$

The converse is trivial. \square

Example 3.1.20 Let \mathcal{A} and \mathcal{B} be algebras and $\phi : \mathcal{A} \rightarrow \mathcal{B}$ a homomorphism. Theorem 2.3.10 ensures that $\phi(\mathcal{A})$ is a subspace of \mathcal{B} . Now let $\mathbf{b}_1, \mathbf{b}_2 \in \phi(\mathcal{A})$. Then there exist $\mathbf{a}_1, \mathbf{a}_2 \in \mathcal{A}$ such that $\mathbf{b}_1 = \phi(\mathbf{a}_1)$ and $\mathbf{b}_2 = \phi(\mathbf{a}_2)$. Furthermore,

$$\mathbf{b}_1 \mathbf{b}_2 = \phi(\mathbf{a}_1) \phi(\mathbf{a}_2) = \phi(\mathbf{a}_1 \mathbf{a}_2), \quad \Rightarrow \quad \mathbf{b}_1 \mathbf{b}_2 \in \phi(\mathcal{A}).$$

Hence, $\phi(\mathcal{A})$ is a subalgebra of \mathcal{B} .

Example 3.1.21 Let \mathcal{A} be a real algebra with identity $\mathbf{1}$. Let $\phi : \mathbb{R} \rightarrow \mathcal{A}$ be the linear mapping given by $\phi(\alpha) = \alpha \mathbf{1}$. Considering \mathbb{R} as an algebra over itself, we have \mathbb{R} (or \mathbb{C}) is a subalgebra of any unital algebra.

$$\phi(\alpha\beta) = \alpha\beta \mathbf{1} = (\alpha \mathbf{1})(\beta \mathbf{1}) = \phi(\alpha) \phi(\beta).$$

This shows that ϕ is an algebra homomorphism. Furthermore,

$$\phi(\alpha_1) = \phi(\alpha_2) \Rightarrow \alpha_1 \mathbf{1} = \alpha_2 \mathbf{1} \Rightarrow (\alpha_1 - \alpha_2) \mathbf{1} = 0 \Rightarrow \alpha_1 = \alpha_2.$$

Hence, ϕ is a monomorphism. Therefore, we can identify \mathbb{R} with $\phi(\mathbb{R})$, and consider \mathbb{R} as a subalgebra of \mathcal{A} . This is the same conclusion we arrived at in Example 3.1.4.

Definition 3.1.22 Let \mathcal{A} and \mathcal{B} be unital algebras. A homomorphism $\phi : \mathcal{A} \rightarrow \mathcal{B}$ is called **unital** if $\phi(\mathbf{1}_A) = \mathbf{1}_B$.

One can show the following:

Proposition 3.1.23 Let \mathcal{A} and \mathcal{B} be unital algebras. If $\phi : \mathcal{A} \rightarrow \mathcal{B}$ is an epimorphism, then ϕ is unital.

Example 3.1.9 introduced the algebra $\mathcal{L}(\mathcal{V})$ of endomorphisms (operators) on \mathcal{V} . This algebra has an identity $\mathbf{1}$ which maps every vector to itself.

Definition 3.1.24 An endomorphism ω of \mathcal{V} whose square is $\mathbf{1}$ is called an **involution**.

In particular, $\mathbf{1} \in \text{End}(\mathcal{V})$ is an involution. If ω_1 and ω_2 are involutions such that $\omega_1 \circ \omega_2 = \omega_2 \circ \omega_1$, then $\omega_1 \circ \omega_2$ is also an involution.

Involutions do not affect the identity of the algebra.

For an algebra, we require that an involution be a homomorphism, not just a linear map. Let \mathcal{A} be an algebra and let $\mathcal{H}(\mathcal{A})$ denote the set of homomorphisms of \mathcal{A} . An involution $\omega \in \mathcal{H}(\mathcal{A})$ satisfies $\omega \circ \omega = \iota \in \mathcal{H}(\mathcal{A})$, of course.⁴ Now, if \mathcal{A} has an identity \mathbf{e} , then $\omega(\mathbf{e})$ must be equal to \mathbf{e} . Indeed, let $\omega(\mathbf{e}) = \mathbf{a}$, then, since $\omega \circ \omega = \iota$, we must have $\omega(\mathbf{a}) = \mathbf{e}$ and

$$\omega(\mathbf{ea}) = \omega(\mathbf{e})\omega(\mathbf{a}) = \omega(\mathbf{e})\mathbf{e} = \omega(\mathbf{e})$$

applying ω to both sides, we get $\mathbf{ea} = \mathbf{e}$. This can happen only if $\mathbf{a} = \mathbf{e}$.

Theorem 3.1.25 Let \mathcal{U} and \mathcal{V} be two isomorphic vector spaces. Then the algebras $\mathcal{L}(\mathcal{U})$ and $\mathcal{L}(\mathcal{V})$ are isomorphic as algebras.

Proof Let $\phi : \mathcal{U} \rightarrow \mathcal{V}$ be a vector-space isomorphism. Define $\Phi : \mathcal{L}(\mathcal{U}) \rightarrow \mathcal{L}(\mathcal{V})$ by

$$\Phi(\mathbf{T}) = \phi \circ \mathbf{T} \circ \phi^{-1}.$$

It is easy to show that Φ is an algebra isomorphism. □

A consequence of this theorem and Theorem 2.3.20 is that $\mathcal{L}(\mathcal{V})$, the algebra of the linear transformations of any real vector space \mathcal{V} , is isomorphic to $\mathcal{L}(\mathbb{R}^N)$, where N is the dimension of \mathcal{V} . Similarly, $\mathcal{L}(\mathcal{V})$ is isomorphic to $\mathcal{L}(\mathbb{C}^N)$ if \mathcal{V} is an N -dimensional complex vector space.

⁴In keeping with our notation, we use ι for the identity homomorphism of the algebra \mathcal{A} .

3.2 Ideals

Subalgebras are subspaces which are stable under multiplication of their elements; i.e., the product of elements of a subalgebra do not leave the subalgebra. Of more importance in algebra theory are those subspaces which are stable under multiplication of its elements by the entire algebra.

Definition 3.2.1 Let \mathcal{A} be an algebra. A subspace \mathcal{B} of \mathcal{A} is called a **left ideal** of \mathcal{A} if it contains $\mathbf{a}\mathbf{b}$ for all $\mathbf{a} \in \mathcal{A}$ and $\mathbf{b} \in \mathcal{B}$. Using Eq. (3.1), we write this as $\mathcal{A}\mathcal{B} \subset \mathcal{B}$. A **right ideal** is defined similarly with $\mathcal{B}\mathcal{A} \subset \mathcal{B}$. A **two-sided ideal**, or simply an **ideal**, is a subspace that is both a left ideal and a right ideal.

left, right, and two-sided ideals

It is clear from the definition that an ideal is automatically a subalgebra, and that the only ideal of a unital algebra containing the identity, or an invertible element, is the algebra itself.

an ideal is a subalgebra

Example 3.2.2 Let \mathcal{A} be an associative algebra and $\mathbf{a} \in \mathcal{A}$. Let $\mathcal{L}(\mathbf{a})$ be the set of elements $\mathbf{x} \in \mathcal{A}$ such that $\mathbf{x}\mathbf{a} = \mathbf{0}$. For any $\mathbf{x} \in \mathcal{L}(\mathbf{a})$ and any $\mathbf{y} \in \mathcal{A}$, we have

left and right annihilators

$$(\mathbf{y}\mathbf{x})\mathbf{a} = \mathbf{y}(\mathbf{x}\mathbf{a}) = \mathbf{0},$$

i.e., $\mathbf{y}\mathbf{x} \in \mathcal{L}(\mathbf{a})$. So, $\mathcal{L}(\mathbf{a})$ is a left ideal in \mathcal{A} . It is called the **left annihilator of \mathbf{a}** . Similarly, one can construct $\mathcal{R}(\mathbf{a})$, the right annihilator of \mathbf{a} .

Example 3.2.3 Let $\mathcal{C}^r(a, b)$ be the algebra of all r times differentiable real-valued functions on an interval (a, b) (see Example 3.1.9). The set of functions that vanish at a given fixed point $c \in (a, b)$ constitutes an ideal in $\mathcal{C}^r(a, b)$. Since the algebra is commutative, the ideal is two-sided.

More generally, let \mathcal{M}_n be the (noncommutative) algebra of matrices with entries $f_{ij} \in \mathcal{C}^r(a, b)$. Then the set of matrices whose entries vanish at a given fixed point $c \in (a, b)$ constitutes a two-sided ideal in \mathcal{M}_n .

Let \mathcal{A} and \mathcal{B} be algebras and $\phi : \mathcal{A} \rightarrow \mathcal{B}$ a homomorphism. By Theorem 2.3.9, $\ker \phi$ is a subspace of \mathcal{A} . Now let $\mathbf{x} \in \ker \phi$ and $\mathbf{a} \in \mathcal{A}$. Then

$$\phi(\mathbf{x}\mathbf{a}) = \phi(\mathbf{x})\phi(\mathbf{a}) = \mathbf{0}\phi(\mathbf{a}) = \mathbf{0},$$

i.e., $\mathbf{x}\mathbf{a} \in \ker \phi$. This shows that $\ker \phi$ is a right ideal in \mathcal{A} . Similarly, one can show that $\ker \phi$ is a left ideal in \mathcal{A} .

Theorem 3.2.4 Let $\phi : \mathcal{A} \rightarrow \mathcal{B}$ be a homomorphism of algebras. Then $\ker \phi$ is a (two-sided) ideal of \mathcal{A} .

One can easily construct left ideals for an associative algebra \mathcal{A} : Take any element $\mathbf{x} \in \mathcal{A}$ and consider the set

ideals generated by an element of an associative algebra

$$\mathcal{A}\mathbf{x} \equiv \{\mathbf{a}\mathbf{x} \mid \mathbf{a} \in \mathcal{A}\}.$$

The reader may check that $\mathcal{A}\mathbf{x}$ is a left ideal. Similarly, $\mathbf{x}\mathcal{A}$ is a right ideal, and the set

$$\mathcal{A}\mathbf{x}\mathcal{A} \equiv \{\mathbf{axb} \mid \mathbf{a}, \mathbf{b} \in \mathcal{A}\}$$

is a two-sided ideal. These are all called left, right, and two-sided **ideals generated by \mathbf{x}** .

minimal left, right, and two-sided ideals

Definition 3.2.5 A left (right, two-sided) ideal \mathcal{M} of an algebra \mathcal{A} is called **minimal** if every left (right, two-sided) ideal of \mathcal{A} contained in \mathcal{M} coincides with \mathcal{M} .

Theorem 3.2.6 Let \mathcal{L} be a left ideal of \mathcal{A} . Then the following statements are equivalent:

- (a) \mathcal{L} is a minimal left ideal.
- (b) $\mathcal{A}\mathbf{x} = \mathcal{L}$ for all $\mathbf{x} \in \mathcal{L}$.
- (c) $\mathcal{L}\mathbf{x} = \mathcal{L}$ for all $\mathbf{x} \in \mathcal{L}$.

Similar conditions hold for a minimal right ideal.

Proof The proof follows directly from the definition of ideals and minimal ideals. \square

Theorem 3.2.7 Let \mathcal{A} and \mathcal{B} be algebras, $\phi : \mathcal{A} \rightarrow \mathcal{B}$ an epimorphism, and \mathcal{L} a (minimal) left ideal of \mathcal{A} . Then $\phi(\mathcal{L})$ is a (minimal) left ideal of \mathcal{B} . In particular, any automorphism of an algebra is an isomorphism among its minimal ideals.

Proof Let \mathbf{b} be any element of \mathcal{B} and \mathbf{y} any element of $\phi(\mathcal{L})$. Then there exist elements \mathbf{a} and \mathbf{x} of \mathcal{A} and \mathcal{L} , respectively, such that $\mathbf{b} = \phi(\mathbf{a})$ and $\mathbf{y} = \phi(\mathbf{x})$. Furthermore,

$$\mathbf{by} = \phi(\mathbf{a})\phi(\mathbf{x}) = \phi(\mathbf{ax}) \in \phi(\mathcal{L})$$

because $\mathbf{ax} \in \mathcal{L}$. Hence, $\phi(\mathcal{L})$ is an ideal in \mathcal{B} .

Now suppose \mathcal{L} is minimal. To show that $\phi(\mathcal{L})$ is minimal, we use (b) of Theorem 3.2.6. Since ϕ is an epimorphism, we have $\mathcal{B} = \phi(\mathcal{A})$. Therefore, let $\mathbf{u} \in \phi(\mathcal{L})$. Then there exists $\mathbf{t} \in \mathcal{L}$ such that $\mathbf{u} = \phi(\mathbf{t})$ and

$$\mathcal{B}\mathbf{u} = \phi(\mathcal{A})\phi(\mathbf{t}) = \phi(\mathcal{A}\mathbf{t}) = \phi(\mathcal{L}).$$

The last statement of the theorem follows from the fact that $\ker \phi$ is an ideal of \mathcal{A} . \square

algebra direct sums

Definition 3.2.8 \mathcal{A} is the **direct sum** of its subalgebras \mathcal{B} and \mathcal{C} if $\mathcal{A} = \mathcal{B} \oplus \mathcal{C}$ as a vector space and $\mathcal{B}\mathcal{C} = \mathcal{C}\mathcal{B} = \{\mathbf{0}\}$. \mathcal{B} and \mathcal{C} are called **components** of \mathcal{A} . Obviously, an algebra can have several components. An algebra is called **reducible** if it is the direct sum of subalgebras.

Table 3.2 The multiplication table for \mathcal{S}

| | \mathbf{f}_1 | \mathbf{f}_2 | \mathbf{f}_3 | \mathbf{f}_4 |
|----------------|----------------|----------------|----------------|----------------|
| \mathbf{f}_1 | \mathbf{f}_1 | \mathbf{f}_2 | $\mathbf{0}$ | $\mathbf{0}$ |
| \mathbf{f}_2 | $\mathbf{0}$ | $\mathbf{0}$ | \mathbf{f}_2 | \mathbf{f}_1 |
| \mathbf{f}_3 | $\mathbf{0}$ | $\mathbf{0}$ | \mathbf{f}_3 | \mathbf{f}_4 |
| \mathbf{f}_4 | \mathbf{f}_4 | \mathbf{f}_3 | $\mathbf{0}$ | $\mathbf{0}$ |

As we saw in Definition 3.1.10, the condition $\mathcal{B}\mathcal{C} = \mathcal{C}\mathcal{B} = \{\mathbf{0}\}$ is necessary if \mathcal{B} and \mathcal{C} are to be naturally identified as $\mathcal{B} \oplus \{\mathbf{0}\}$ and $\mathcal{C} \oplus \{\mathbf{0}\}$, respectively.

Proposition 3.2.9 *A central algebra is not reducible.*

Proof Suppose that the (necessarily unital) central algebra \mathcal{A} is reducible. Then the identity has components in each of the subalgebras of which \mathcal{A} is composed. Clearly, these components are linearly independent and all belong to the center. This is a contradiction. \square

Example 3.2.10 Consider \mathcal{S} , the algebra introduced in Example 3.1.7. Construct a new basis $\{\mathbf{f}_i\}_{i=1}^4$ as follows:⁵

$$\begin{aligned} \mathbf{f}_1 &= \frac{1}{2}(\mathbf{e}_0 + \mathbf{e}_3), & \mathbf{f}_2 &= \frac{1}{2}(\mathbf{e}_1 - \mathbf{e}_2), \\ \mathbf{f}_3 &= \frac{1}{2}(\mathbf{e}_0 - \mathbf{e}_3), & \mathbf{f}_4 &= \frac{1}{2}(\mathbf{e}_1 + \mathbf{e}_2). \end{aligned} \quad (3.9)$$

The multiplication table for \mathcal{S} in terms of the new basis vectors is given in Table 3.2, as the reader may verify.

Multiplying both sides of the identity $\mathbf{e}_0 = \mathbf{f}_1 + \mathbf{f}_3$ by an arbitrary element of \mathcal{S} , we see that any such element can be written as a vector in the left ideal $\mathcal{L}_1 \equiv \mathcal{S}\mathbf{f}_1$ plus a vector in the left ideal $\mathcal{L}_3 \equiv \mathcal{S}\mathbf{f}_3$. Any vector in \mathcal{L}_1 can be written as a product of some vector in \mathcal{S} and \mathbf{f}_1 . Let $\mathbf{a} = \sum_{i=1}^4 \alpha_i \mathbf{f}_i$ be an arbitrary element of \mathcal{S} . Then any vector in \mathcal{L}_1 is of the form

$$\mathbf{a}\mathbf{f}_1 = (\alpha_1\mathbf{f}_1 + \alpha_2\mathbf{f}_2 + \alpha_3\mathbf{f}_3 + \alpha_4\mathbf{f}_4)\mathbf{f}_1 = \alpha_1\mathbf{f}_1 + \alpha_4\mathbf{f}_4,$$

i.e., that \mathbf{f}_1 and \mathbf{f}_4 span \mathcal{L}_1 . Similarly, \mathbf{f}_2 and \mathbf{f}_3 span \mathcal{L}_3 . It follows that $\mathcal{L}_1 \cap \mathcal{L}_3 = \{\mathbf{0}\}$. Therefore, we have

$$\mathcal{S} = \mathcal{L}_1 \oplus_V \mathcal{L}_3, \quad \mathcal{L}_1 = \text{Span}\{\mathbf{f}_1, \mathbf{f}_4\}, \quad \mathcal{L}_3 = \text{Span}\{\mathbf{f}_2, \mathbf{f}_3\},$$

where \oplus_V indicates a vector space direct sum. Note that there is no contradiction between this direct sum decomposition and the fact that \mathcal{S} is central because the direct sum above is not an algebra direct sum since $\mathcal{L}_1\mathcal{L}_3 \neq \{\mathbf{0}\}$.

⁵The reader is advised to show that $\{\mathbf{f}_i\}_{i=1}^4$ is a linearly independent set of vectors.

Let $\mathbf{x} = \gamma_1 \mathbf{f}_1 + \gamma_4 \mathbf{f}_4$ be an arbitrary nonzero element of \mathcal{L}_1 . Then clearly, $S\mathbf{x} \subseteq \mathcal{L}_1$. To show that $\mathcal{L}_1 \subseteq S\mathbf{x}$, let $\mathbf{y} = \beta_1 \mathbf{f}_1 + \beta_4 \mathbf{f}_4$ be in \mathcal{L}_1 . Can we find $\mathbf{z} \in S$ such that $\mathbf{y} = \mathbf{z}\mathbf{x}$? Let $\mathbf{z} = \sum_{i=1}^4 \eta_i \mathbf{f}_i$ and note that

$$\begin{aligned} \mathbf{z}\mathbf{x} &= (\eta_1 \mathbf{f}_1 + \eta_2 \mathbf{f}_2 + \eta_3 \mathbf{f}_3 + \eta_4 \mathbf{f}_4)(\gamma_1 \mathbf{f}_1 + \gamma_4 \mathbf{f}_4) \\ &= (\eta_1 \gamma_1 + \eta_2 \gamma_4) \mathbf{f}_1 + (\eta_3 \gamma_4 + \eta_4 \gamma_1) \mathbf{f}_4. \end{aligned}$$

We are looking for a set of η 's satisfying

$$\eta_1 \gamma_1 + \eta_2 \gamma_4 = \beta_1 \quad \text{and} \quad \eta_3 \gamma_4 + \eta_4 \gamma_1 = \beta_4.$$

If $\gamma_1 \neq 0$, then $\eta_1 = \beta_1/\gamma_1$, $\eta_2 = 0 = \eta_3$, $\eta_4 = \beta_4/\gamma_1$ yields a solution for \mathbf{z} . If $\gamma_4 \neq 0$, then $\eta_2 = \beta_1/\gamma_4$, $\eta_1 = 0 = \eta_4$, $\eta_3 = \beta_4/\gamma_4$ yields a solution for \mathbf{z} . Therefore, $\mathcal{L}_1 = S\mathbf{x}$, and by Theorem 3.2.6, \mathcal{L}_1 is minimal. Similarly, \mathcal{L}_3 is also minimal.

If $\mathcal{A} = \mathcal{B} \oplus \mathcal{C}$, then multiplying both sides on the right by \mathcal{B} , we get

$$\mathcal{A}\mathcal{B} = \mathcal{B}\mathcal{B} \oplus \mathcal{C}\mathcal{B} = \mathcal{B}\mathcal{B} \oplus \{\mathbf{0}\} = \mathcal{B}\mathcal{B} \subseteq \mathcal{B},$$

showing that \mathcal{B} is a left ideal of \mathcal{A} . Likewise, multiplying on the left leads to the fact that \mathcal{B} is a right ideal of \mathcal{A} . Thus it is an ideal of \mathcal{A} . Similarly, \mathcal{C} is an ideal of \mathcal{A} . Moreover, since the subalgebras do not share any nonzero elements, any other ideal of \mathcal{A} must be contained in the subalgebras. We thus have

Proposition 3.2.11 *If \mathcal{A} is the direct sum of algebras, then each component (or the direct sum of several components) is an ideal of \mathcal{A} . Furthermore, any other ideal of \mathcal{A} is contained entirely in one of the components.*

simple algebra Algebras which have no proper ideals are important in the classification of all algebras.

Definition 3.2.12 An algebra \mathcal{A} is called **simple** if its only ideals are \mathcal{A} and $\{\mathbf{0}\}$.

Recall that by ideal we mean two-sided ideal. Therefore, a simple algebra can have proper left ideals and proper right ideals. In fact, the following example illustrates this point.

Example 3.2.13 Let's go back to algebra S of Example 3.2.10, where we saw that $S = \mathcal{L}_1 \oplus_V \mathcal{L}_3$ in which \mathcal{L}_1 and \mathcal{L}_3 are minimal left ideals and \oplus_V indicates direct sum of vector spaces. Can S have a proper two-sided ideal? Let \mathcal{J} be such an ideal and let $\mathbf{a} \in \mathcal{J}$ be nonzero. By the decomposition of S , $\mathbf{a} = \mathbf{a}_1 + \mathbf{a}_3$ with $\mathbf{a}_1 \in \mathcal{L}_1$ and $\mathbf{a}_3 \in \mathcal{L}_3$, at least one of which must be nonzero. Suppose $\mathbf{a}_1 \neq \mathbf{0}$. Then $S\mathbf{a}_1$ is a nonzero left ideal which is contained in \mathcal{L}_1 . Since \mathcal{L}_1 is minimal, $S\mathbf{a}_1 = \mathcal{L}_1$. Since $\mathbf{f}_1 \in \mathcal{L}_1$ there must exist

$\mathbf{b} \in \mathcal{S}$ such that $\mathbf{ba}_1 = \mathbf{f}_1$, and hence,

$$\mathbf{ba} = \mathbf{ba}_1 + \mathbf{ba}_3 = \mathbf{f}_1 + \mathbf{ba}_3.$$

Multiplying both sides on the right by \mathbf{f}_1 and noting that $\mathbf{f}_1^2 = \mathbf{f}_1$ and $\mathcal{L}_3\mathbf{f}_1 = \{\mathbf{0}\}$ by the multiplication table of Example 3.2.10, we obtain $\mathbf{baf}_1 = \mathbf{f}_1$. Since \mathcal{J} is a two-sided ideal and $\mathbf{a} \in \mathcal{J}$, $\mathbf{baf}_1 \in \mathcal{J}$, and therefore, $\mathbf{f}_1 \in \mathcal{J}$.

The equality $\mathcal{S}\mathbf{a}_1 = \mathcal{L}_1$, also implies that there exists $\mathbf{c} \in \mathcal{S}$ such that $\mathbf{ca}_1 = \mathbf{f}_4$, and hence,

$$\mathbf{ca} = \mathbf{ca}_1 + \mathbf{ca}_3 = \mathbf{f}_4 + \mathbf{ca}_3.$$

Multiplying both sides on the right by \mathbf{f}_1 and noting that $\mathbf{f}_4\mathbf{f}_1 = \mathbf{f}_4$ and $\mathcal{L}_3\mathbf{f}_1 = \{\mathbf{0}\}$, we obtain $\mathbf{caf}_1 = \mathbf{f}_4$. Since \mathcal{J} is a two-sided ideal, we must have $\mathbf{f}_4 \in \mathcal{J}$. Since $\mathbf{f}_1\mathbf{f}_2 = \mathbf{f}_2$ and $\mathbf{f}_4\mathbf{f}_2 = \mathbf{f}_3$, all the basis vectors are in \mathcal{J} . Hence, $\mathcal{J} = \mathcal{S}$. The case where $\mathbf{a}_3 \neq \mathbf{0}$ leads to the same conclusion. Therefore, \mathcal{S} has no *proper* ideal, i.e., \mathcal{S} is simple.

An immediate consequence of Definition 3.2.12 and Theorem 3.2.4 is

Proposition 3.2.14 *A nontrivial homomorphism of a simple algebra \mathcal{A} with any other algebra \mathcal{B} is necessarily injective.*

Proof For any $\phi : \mathcal{A} \rightarrow \mathcal{B}$, the kernel of ϕ is an ideal of \mathcal{A} . Since \mathcal{A} has no proper ideal, $\ker \phi = \mathcal{A}$ or $\ker \phi = \{\mathbf{0}\}$. If ϕ is nontrivial, then $\ker \phi = \{\mathbf{0}\}$, i.e., ϕ is injective. \square

3.2.1 Factor Algebras

Let \mathcal{A} be an algebra and \mathcal{B} a subspace of \mathcal{A} . Section 2.1.2 showed how to construct the factor space \mathcal{A}/\mathcal{B} . Can this space be turned into an algebra? Let $[\mathbf{a}]$ and $[\mathbf{a}']$ be in \mathcal{A}/\mathcal{B} . Then the natural product rule for making \mathcal{A}/\mathcal{B} an algebra is

$$[\mathbf{a}][\mathbf{a}'] = [\mathbf{aa}']. \quad (3.10)$$

Under what conditions does this multiplication make sense? Since $[\mathbf{a}] = [\mathbf{a} + \mathbf{b}]$ and $[\mathbf{a}'] = [\mathbf{a}' + \mathbf{b}']$ for all $\mathbf{b}, \mathbf{b}' \in \mathcal{B}$, for (3.10) to make sense, we must have

$$(\mathbf{a} + \mathbf{b})(\mathbf{a}' + \mathbf{b}') = \mathbf{aa}' + \mathbf{b}''$$

for some $\mathbf{b}'' \in \mathcal{B}$. Taking $\mathbf{a} = \mathbf{0} = \mathbf{a}'$ yields $\mathbf{bb}' = \mathbf{b}''$. This means that \mathcal{B} must be a subalgebra of \mathcal{A} . Taking $\mathbf{a}' = \mathbf{0}$ yields $\mathbf{ab}' + \mathbf{bb}' = \mathbf{b}''$ for all $\mathbf{a} \in \mathcal{A}$, $\mathbf{b}, \mathbf{b}' \in \mathcal{B}$ and some $\mathbf{b}'' \in \mathcal{B}$. This means that \mathcal{B} must be a left ideal of \mathcal{A} . Similarly, by setting $\mathbf{a} = \mathbf{0}$ we conclude that \mathcal{B} must be a right ideal of \mathcal{A} . We thus have

Proposition 3.2.15 *Let \mathcal{A} be an algebra and \mathcal{B} a subspace of \mathcal{A} . Then the factor space \mathcal{A}/\mathcal{B} can be turned into an algebra with multiplication $[\mathbf{a}][\mathbf{a}'] = [\mathbf{aa}']$, if and only if \mathcal{B} is an ideal in \mathcal{A} . The algebra so constructed is called the **factor algebra** of \mathcal{A} with respect to the ideal \mathcal{B} .*

factor algebra

Example 3.2.16 Let \mathcal{A} and \mathcal{B} be algebras and $\phi : \mathcal{A} \rightarrow \mathcal{B}$ an algebra homomorphism. Example 3.1.20 and Theorem 3.2.4 showed that $\phi(\mathcal{A})$ is a subalgebra of \mathcal{B} and $\ker \phi$ is an ideal in \mathcal{A} . Now consider the linear map $\bar{\phi} : \mathcal{A}/\ker \phi \rightarrow \phi(\mathcal{A})$ defined in Example 2.3.22 by $\bar{\phi}([\mathbf{a}]) = \phi(\mathbf{a})$. It is straightforward to show that $\bar{\phi}$ is an algebra homomorphism. Using this and Example 2.3.22 where it was shown that $\bar{\phi}$ is a linear isomorphism, we conclude that ϕ is an algebra isomorphism.

3.3 Total Matrix Algebra

Consider the vector space of $n \times n$ matrices with its standard basis $\{\mathbf{e}_{ij}\}_{i,j=1}^n$, where \mathbf{e}_{ij} has a 1 at the ij th position and zero everywhere else. This means that $(\mathbf{e}_{ij})_{lk} = \delta_{il}\delta_{jk}$, and

$$\begin{aligned} (\mathbf{e}_{ij}\mathbf{e}_{kl})_{mn} &= \sum_{r=1}^n (\mathbf{e}_{ij})_{mr}(\mathbf{e}_{kl})_{rn} \\ &= \sum_{r=1}^n \delta_{im}\delta_{jr}\delta_{kr}\delta_{ln} = \delta_{im}\delta_{jk}\delta_{ln} = \delta_{jk}(\mathbf{e}_{il})_{mn}, \end{aligned}$$

or

$$\mathbf{e}_{ij}\mathbf{e}_{kl} = \delta_{jk}\mathbf{e}_{il}.$$

The structure constants are $c_{ij,kl}^{mn} = \delta_{im}\delta_{jk}\delta_{ln}$. Note that one needs a double index to label these constants.

The abstract algebra whose basis is $\{\mathbf{e}_{ij}\}_{i,j=1}^n$ with multiplication rules and structure constants given above is called the **total matrix algebra**. Let \mathbb{F} denote either \mathbb{R} or \mathbb{C} . Then the total matrix algebra over \mathbb{F} is denoted by $\mathbb{F} \otimes \mathcal{M}_n$ or $\mathcal{M}_n(\mathbb{F})$. It is an associative algebra isomorphic with the real or complex matrix algebra, but its elements are not necessarily $n \times n$ matrices. When the dimension of the matrices is not specified, one writes simply $\mathbb{F} \otimes \mathcal{M}$ or $\mathcal{M}(\mathbb{F})$.

We now construct a left ideal of this algebra. Take \mathbf{e}_{pq} and multiply it on the left by $\sum_{i,j=1}^n \alpha_{ij}\mathbf{e}_{ij}$, a general element of $\mathcal{M}_n(\mathbb{F})$. This yields

$$\left(\sum_{i,j=1}^n \alpha_{ij}\mathbf{e}_{ij} \right) \mathbf{e}_{pq} = \sum_{i,j=1}^n \alpha_{ij}\mathbf{e}_{ij}\mathbf{e}_{pq} = \sum_{i,j=1}^n \alpha_{ij}\delta_{jp}\mathbf{e}_{iq} = \sum_{i=1}^n \alpha_{ip}\mathbf{e}_{iq},$$

which corresponds to a matrix all of whose columns are zero except the q th column. Let \mathcal{L} be the set of all such matrices. Multiplying an element of \mathcal{L} by a general matrix $\sum_{l,m=1}^n \beta_{lm}\mathbf{e}_{lm}$, we obtain⁶

$$\left(\sum_{l,m=1}^n \beta_{lm}\mathbf{e}_{lm} \right) \left(\sum_{i=1}^n \gamma_i\mathbf{e}_{iq} \right) = \sum_{i,l,m=1}^n \beta_{lm}\gamma_i\mathbf{e}_{lm}\mathbf{e}_{iq} = \sum_{i,l,m=1}^n \beta_{lm}\gamma_i\delta_{mi}\mathbf{e}_{lq}$$

⁶The index p has no significance in the final answer because all the \mathbf{e}_{pq} with varying p but a fixed q generate the same matrices.

$$\begin{aligned}
&= \sum_{l,m=1}^n \beta_{lm} \gamma_m \mathbf{e}_{lq} = \sum_{l=1}^n \underbrace{\left(\sum_{m=1}^n \beta_{lm} \gamma_m \right)}_{\equiv \eta_l} \mathbf{e}_{lq} \\
&= \sum_{l=1}^n \eta_l \mathbf{e}_{lq}.
\end{aligned}$$

It follows that \mathcal{L} is a left ideal. Furthermore, the very construction of \mathcal{L} implies that it satisfies condition (b) of Theorem 3.2.6. Had we multiplied \mathbf{e}_{pq} on the right, we would have obtained a right ideal consisting of matrices all of whose rows equaled zero except the p th row; and this right ideal would satisfy condition (b) of Theorem 3.2.6 for right minimal ideals. We thus have

Theorem 3.3.1 *The minimal left (right) ideals of $\mathbb{R} \otimes \mathcal{M}$ or $\mathbb{C} \otimes \mathcal{M}$ consist of matrices with all their columns (rows) zero except one.*

Multiplying \mathbf{e}_{pq} on the left and the right by a pair of arbitrary matrices, the reader can easily show that one recovers the entire total matrix algebra. This indicates that the algebra has no proper two-sided ideal. Example 3.3.3 below finds the center of $\mathcal{M}_n(\mathbb{F})$ to be $\text{Span}\{\mathbf{1}_n\}$, where $\mathbf{1}_n$ is the identity of $\mathcal{M}_n(\mathbb{F})$. We thus have

Theorem 3.3.2 *The total matrix algebra $\mathcal{M}_n(\mathbb{F})$ is central simple.*

Example 3.3.3 Let $\mathbf{a} = \sum_{i,j=1}^n \alpha_{ij} \mathbf{e}_{ij}$ be in the center of $\mathbb{F} \otimes \mathcal{M}_n$. Then

finding the center of $\mathbb{F} \otimes \mathcal{M}_n$

$$\begin{aligned}
\mathbf{a} \mathbf{e}_{kl} &= \sum_{i,j=1}^n \alpha_{ij} \mathbf{e}_{ij} \mathbf{e}_{kl} = \sum_{i,j=1}^n \alpha_{ij} \delta_{jk} \mathbf{e}_{il} = \sum_{i=1}^n \alpha_{ik} \mathbf{e}_{il} \\
\mathbf{e}_{kl} \mathbf{a} &= \sum_{i,j=1}^n \mathbf{e}_{kl} \alpha_{ij} \mathbf{e}_{ij} = \sum_{i,j=1}^n \alpha_{ij} \delta_{il} \mathbf{e}_{kj} = \sum_{j=1}^n \alpha_{lj} \mathbf{e}_{kj}.
\end{aligned}$$

For these two expressions to be equal, we must have

$$\sum_{i=1}^n (\alpha_{ik} \mathbf{e}_{il} - \alpha_{li} \mathbf{e}_{ki}) = 0.$$

By letting $l = k$ in the sum above and invoking the linear independence of \mathbf{e}_{ij} , we conclude that $\alpha_{ik} = 0$ if $i \neq k$. Therefore, \mathbf{a} must be a diagonal matrix. Write $\mathbf{a} = \sum_{k=1}^n \lambda_k \mathbf{e}_{kk}$ and let $\mathbf{b} = \sum_{i,j=1}^n \beta_{ij} \mathbf{e}_{ij}$ be an arbitrary element of $\mathbb{F} \otimes \mathcal{M}_n$. Then

$$\mathbf{a} \mathbf{b} = \sum_{i,j,k=1}^n \lambda_k \beta_{ij} \mathbf{e}_{kk} \mathbf{e}_{ij} = \sum_{i,j,k=1}^n \lambda_k \beta_{ij} \delta_{ik} \mathbf{e}_{kj} = \sum_{i,j=1}^n \lambda_i \beta_{ij} \mathbf{e}_{ij}$$

$$\mathbf{ba} = \sum_{i,j,k=1}^n \lambda_k \beta_{ij} \mathbf{e}_{ij} \mathbf{e}_{kk} = \sum_{i,j,k=1}^n \lambda_k \beta_{ij} \delta_{jk} \mathbf{e}_{ik} = \sum_{i,j=1}^n \lambda_j \beta_{ij} \mathbf{e}_{ij}.$$

Again, because of the linear independence of \mathbf{e}_{ij} , for these two expressions to be equal, we must have $\lambda_j \beta_{ij} = \lambda_i \beta_{ij}$ for all i and j and all β_{ij} . The only way this can happen is for λ_i to be equal to λ_j for all i and j . It follows that $\mathbf{a} = \lambda \mathbf{1}_n$, where $\mathbf{1}_n = \sum_{k=1}^n \mathbf{e}_{kk}$ is the identity element of $\mathcal{M}_n(\mathbb{F})$. Therefore, $\mathcal{M}_n(\mathbb{F})$ is central.

3.4 Derivation of an Algebra

The last two items in Example 3.1.9 have a feature that turns out to be of great significance in all algebras, the product rule for differentiation.

Definition 3.4.1 A vector space endomorphism $\mathbf{D} : \mathcal{A} \rightarrow \mathcal{A}$ is called a **derivation** on \mathcal{A} if it has the additional property

$$\mathbf{D}(\mathbf{ab}) = [\mathbf{D}(\mathbf{a})]\mathbf{b} + \mathbf{a}[\mathbf{D}(\mathbf{b})].$$

Example 3.4.2 Let $\mathcal{C}^r(a, b)$ be as in Example 3.1.9, and let \mathbf{D} be ordinary differentiation: $\mathbf{D} : f \mapsto f'$ where f' is the derivative of f . Then ordinary differentiation rules show that \mathbf{D} is a derivation of the algebra $\mathcal{C}^r(a, b)$.

Example 3.4.3 Consider the algebra of $n \times n$ matrices with multiplication as defined in Eq. (3.3). Let \mathbf{A} be a fixed matrix, and define the linear transformation

$$\mathbf{D}_A(\mathbf{B}) = \mathbf{A} \bullet \mathbf{B}.$$

Then we note that

$$\begin{aligned} \mathbf{D}_A(\mathbf{B} \bullet \mathbf{C}) &= \mathbf{A} \bullet (\mathbf{B} \bullet \mathbf{C}) = \mathbf{A}(\mathbf{B} \bullet \mathbf{C}) - (\mathbf{B} \bullet \mathbf{C})\mathbf{A} \\ &= \mathbf{A}(\mathbf{BC} - \mathbf{CB}) - (\mathbf{BC} - \mathbf{CB})\mathbf{A} \\ &= \mathbf{ABC} - \mathbf{ACB} - \mathbf{BCA} + \mathbf{CBA}. \end{aligned}$$

On the other hand,

$$\begin{aligned} (\mathbf{D}_A\mathbf{B}) \bullet \mathbf{C} + \mathbf{B} \bullet (\mathbf{D}_A\mathbf{C}) &= (\mathbf{A} \bullet \mathbf{B}) \bullet \mathbf{C} + \mathbf{B} \bullet (\mathbf{A} \bullet \mathbf{C}) \\ &= (\mathbf{AB} - \mathbf{BA}) \bullet \mathbf{C} + \mathbf{B} \bullet (\mathbf{AC} - \mathbf{CA}) \\ &= (\mathbf{AB} - \mathbf{BA})\mathbf{C} - \mathbf{C}(\mathbf{AB} - \mathbf{BA}) + \mathbf{B}(\mathbf{AC} - \mathbf{CA}) \\ &\quad - (\mathbf{AC} - \mathbf{CA})\mathbf{B} \\ &= \mathbf{ABC} + \mathbf{CBA} - \mathbf{BCA} - \mathbf{ACB}. \end{aligned}$$

So, \mathbf{D}_A is a derivation on \mathcal{A} .

Theorem 3.4.4 Let $\{\mathbf{e}_i\}_{i=1}^N$ be a basis of the algebra \mathcal{A} . Then a vector space endomorphism $\mathbf{D} : \mathcal{A} \rightarrow \mathcal{A}$ is a derivation on \mathcal{A} iff

$$\mathbf{D}(\mathbf{e}_i \mathbf{e}_j) = \mathbf{D}(\mathbf{e}_i) \cdot \mathbf{e}_j + \mathbf{e}_i \cdot \mathbf{D}(\mathbf{e}_j) \quad \text{for } i, j = 1, 2, \dots, N.$$

Proof The simple proof is left as an exercise for the reader. \square

If \mathcal{A} has an identity \mathbf{e} , then $\mathbf{D}(\mathbf{e}) = \mathbf{0}$, because

$$\mathbf{D}(\mathbf{e}) = \mathbf{D}(\mathbf{e}\mathbf{e}) = \mathbf{D}(\mathbf{e})\mathbf{e} + \mathbf{e}\mathbf{D}(\mathbf{e}) = 2\mathbf{D}(\mathbf{e}).$$

This shows that $\mathbf{e} \in \ker \mathbf{D}$. In general, one can show that $\ker \mathbf{D}$ is a subalgebra of \mathcal{A} .

Proposition 3.4.5 Every derivation \mathbf{D} satisfies the *Leibniz formula*

Leibniz formula

$$\mathbf{D}^n(\mathbf{a}\mathbf{b}) = \sum_{k=0}^n \binom{n}{k} \mathbf{D}^k(\mathbf{a}) \cdot \mathbf{D}^{n-k}(\mathbf{b}). \quad (3.11)$$

Proof The proof by mathematical induction is very similar to the proof of the binomial theorem of Example 1.5.2. The details are left as an exercise for the reader. \square

Derivations of \mathcal{A} , being endomorphisms of the *vector space* \mathcal{A} , are subsets of $\text{End}(\mathcal{A})$. If \mathbf{D}_1 and \mathbf{D}_2 are derivations, then it is straightforward to show that any linear combination $\alpha\mathbf{D}_1 + \beta\mathbf{D}_2$ is also a derivation. Thus, the set of derivations $\mathcal{D}(\mathcal{A})$ on an algebra \mathcal{A} forms a vector space [a subspace of $\text{End}(\mathcal{A})$]. Do they form a *subalgebra* of $\text{End}(\mathcal{A})$? Is $\mathbf{D}_1\mathbf{D}_2$ a derivation? Let's find out!

$$\begin{aligned} \mathbf{D}_1\mathbf{D}_2(\mathbf{a}\mathbf{b}) &= \mathbf{D}_1([\mathbf{D}_2(\mathbf{a})]\mathbf{b} + \mathbf{a}[\mathbf{D}_2(\mathbf{b})]) \\ &= [\mathbf{D}_1\mathbf{D}_2(\mathbf{a})]\mathbf{b} + \mathbf{D}_2(\mathbf{a})\mathbf{D}_1(\mathbf{b}) + \mathbf{D}_1(\mathbf{a})\mathbf{D}_2(\mathbf{b}) + \mathbf{a}[\mathbf{D}_1\mathbf{D}_2(\mathbf{b})]. \end{aligned}$$

So, the product of two derivations is not a derivation, because of the two terms in the middle. However, since these terms are symmetric in their subscripts, we can subtract them away by taking the difference $\mathbf{D}_1\mathbf{D}_2 - \mathbf{D}_2\mathbf{D}_1$. The question is whether the result will be a derivation. Switching the order of the subscripts, we obtain

$$\mathbf{D}_2\mathbf{D}_1(\mathbf{a}\mathbf{b}) = [\mathbf{D}_2\mathbf{D}_1(\mathbf{a})]\mathbf{b} + \mathbf{D}_1(\mathbf{a})\mathbf{D}_2(\mathbf{b}) + \mathbf{D}_2(\mathbf{a})\mathbf{D}_1(\mathbf{b}) + \mathbf{a}[\mathbf{D}_2\mathbf{D}_1(\mathbf{b})].$$

Subtracting this from the previous expression yields

$$\begin{aligned} &(\mathbf{D}_1\mathbf{D}_2 - \mathbf{D}_2\mathbf{D}_1)(\mathbf{a}\mathbf{b}) \\ &= [\mathbf{D}_1\mathbf{D}_2(\mathbf{a})]\mathbf{b} + \mathbf{a}[\mathbf{D}_1\mathbf{D}_2(\mathbf{b})] - [\mathbf{D}_2\mathbf{D}_1(\mathbf{a})]\mathbf{b} - \mathbf{a}[\mathbf{D}_2\mathbf{D}_1(\mathbf{b})] \\ &= [(\mathbf{D}_1\mathbf{D}_2 - \mathbf{D}_2\mathbf{D}_1)(\mathbf{a})]\mathbf{b} + \mathbf{a}[(\mathbf{D}_1\mathbf{D}_2 - \mathbf{D}_2\mathbf{D}_1)(\mathbf{b})]. \end{aligned}$$

Thus, if we define a new product

$$\mathbf{D}_1 \bullet \mathbf{D}_2 \equiv \mathbf{D}_1\mathbf{D}_2 - \mathbf{D}_2\mathbf{D}_1, \quad (3.12)$$

then $\mathcal{D}(\mathcal{A})$ becomes an algebra.

Theorem 3.4.6 *The set $\mathcal{D}(\mathcal{A})$ of derivations of \mathcal{A} forms an algebra, the derivation algebra* **derivation algebra** *of \mathcal{A} under the product (3.12).*

Definition 3.4.7 Let \mathcal{A} and \mathcal{B} be algebras, and $\phi : \mathcal{A} \rightarrow \mathcal{B}$ a homomorphism. Then $\mathbf{D} : \mathcal{A} \rightarrow \mathcal{B}$ is called a **ϕ -derivation** if

$$\mathbf{D}(\mathbf{a}_1 \mathbf{a}_2) = \mathbf{D}(\mathbf{a}_1)\phi(\mathbf{a}_2) + \phi(\mathbf{a}_1)\mathbf{D}(\mathbf{a}_2), \quad \mathbf{a}_1, \mathbf{a}_2 \in \mathcal{A}.$$

Example 3.4.8 As an example, let \mathbf{D}_A be a derivation in \mathcal{A} . Then $\mathbf{D} = \phi \circ \mathbf{D}_A$ is a ϕ -derivation, because

$$\begin{aligned} \phi \circ \mathbf{D}_A(\mathbf{a}_1 \mathbf{a}_2) &= \phi[\mathbf{D}_A(\mathbf{a}_1)\mathbf{a}_2 + \mathbf{a}_1\mathbf{D}_A(\mathbf{a}_2)] \\ &= \phi[\mathbf{D}_A(\mathbf{a}_1)]\phi(\mathbf{a}_2) + \phi(\mathbf{a}_1)\phi[\mathbf{D}_A(\mathbf{a}_2)] \\ &= \phi \circ \mathbf{D}_A(\mathbf{a}_1)\phi(\mathbf{a}_2) + \phi(\mathbf{a}_1)\phi \circ \mathbf{D}_A(\mathbf{a}_2). \end{aligned}$$

Similarly, if \mathbf{D}_B is a derivation in \mathcal{B} , then $\mathbf{D}_B \circ \phi$ is a ϕ -derivation.

More specifically, let \mathcal{A} be the algebra $\mathcal{C}^r(a, b)$ of r -time differentiable functions, and \mathcal{B} be the algebra \mathbb{R} of real numbers. Let $\phi_c : \mathcal{C}^r(a, b) \rightarrow \mathbb{R}$ be the evaluation at a fixed point $c \in (a, b)$, so that $\phi_c(f) = f(c)$. If $\mathbf{D}_c : \mathcal{C}^r(a, b) \rightarrow \mathbb{R}$ is defined as $\mathbf{D}_c(f) = f'(c)$, then one can readily show that \mathbf{D}_c is a ϕ_c -derivation.

Definition 3.4.9 Let \mathcal{A} be an algebra with identity and ω an involution of \mathcal{A} . A linear transformation $\mathbf{\Omega} \in \mathcal{L}(\mathcal{A})$ is called an **antiderivation** of \mathcal{A} with respect to ω if

$$\mathbf{\Omega}(\mathbf{a}_1 \mathbf{a}_2) = \mathbf{\Omega}(\mathbf{a}_1) \cdot \mathbf{a}_2 + \omega(\mathbf{a}_1) \cdot \mathbf{\Omega}(\mathbf{a}_2).$$

In particular, a derivation is an antiderivation with respect to the identity.

As in the case of the derivation, one can show that $\ker \mathbf{\Omega}$ is a subalgebra of \mathcal{A} , $\mathbf{\Omega}(\mathbf{e}) = \mathbf{0}$ if \mathcal{A} has an identity \mathbf{e} , and $\mathbf{\Omega}$ is determined entirely by its action on the generators of \mathcal{A} .

Theorem 3.4.10 *Let $\mathbf{\Omega}_1$ and $\mathbf{\Omega}_2$ be antiderivations with respect to two involutions ω_1 and ω_2 . Suppose that $\omega_1 \circ \omega_2 = \omega_2 \circ \omega_1$. Furthermore assume that*

$$\omega_1 \mathbf{\Omega}_2 = \pm \mathbf{\Omega}_2 \omega_1 \quad \text{and} \quad \omega_2 \mathbf{\Omega}_1 = \pm \mathbf{\Omega}_1 \omega_2.$$

Then $\mathbf{\Omega}_1 \mathbf{\Omega}_2 \mp \mathbf{\Omega}_2 \mathbf{\Omega}_1$ is an antiderivation with respect to the involution $\omega_1 \circ \omega_2$.

Proof The proof consists of evaluating $\mathbf{\Omega}_1 \mathbf{\Omega}_2 \mp \mathbf{\Omega}_2 \mathbf{\Omega}_1$ using Definition 3.4.9 for $\mathbf{\Omega}_1$ and $\mathbf{\Omega}_2$. We leave the straightforward proof for the reader. \square

Some particular cases of this theorem are of interest:

- Let $\mathbf{\Omega}$ be an antiderivation with respect to ω and \mathbf{D} a derivation such that $\omega \mathbf{D} = \mathbf{D} \omega$. Then $\mathbf{D} \mathbf{\Omega} - \mathbf{\Omega} \mathbf{D}$ is an antiderivation with respect to ω .

- Let Ω_1 and Ω_2 be antiderivations with respect to the same involution ω such that $\omega\Omega_i = -\Omega_i\omega$ for $i = 1, 2$. Then $\Omega_1\Omega_2 + \Omega_2\Omega_1$ is a derivation.
- A particular example of the second case is when Ω is an antiderivation with respect to an involution ω such that $\omega\Omega = -\Omega\omega$. Then Ω^2 is a derivation.

3.5 Decomposition of Algebras

In Sect. 2.1.3, we decomposed a vector space into smaller vector spaces. The decomposition of algebras into “smaller” algebras is also useful. In this section we investigate properties and conditions which allow such a decomposition. All algebras in this section are assumed to be associative.

Definition 3.5.1 A nonzero element $\mathbf{a} \in \mathcal{A}$ is called **nilpotent** if $\mathbf{a}^k = \mathbf{0}$ for some positive integer k . The smallest such integer is called the **index** of \mathbf{a} . A subalgebra \mathcal{B} of \mathcal{A} is called **nil** if all elements of \mathcal{B} are nilpotent. \mathcal{B} is called nilpotent of index ν if $\mathcal{B}^\nu = \{\mathbf{0}\}$ and $\mathcal{B}^{\nu-1} \neq \{\mathbf{0}\}$.⁷ A nonzero element $\mathbf{P} \in \mathcal{A}$ is called **idempotent** if $\mathbf{P}^2 = \mathbf{P}$.

nilpotent, index, nil, and idempotent

Proposition 3.5.2 *The identity element is the only idempotent in a division algebra.*

Proof The proof is trivial. □

If \mathbf{P} is an idempotent, then $\mathbf{P}^k = \mathbf{P}$ for any positive integer k . Therefore, a nilpotent subalgebra cannot contain an idempotent.

The following theorem, whose rather technical proof can be found in [Bly 90, p. 191], is very useful:

Theorem 3.5.3 *A nil ideal is nilpotent.*

Example 3.5.4 The set of $n \times n$ upper triangular matrices is a subalgebra of the algebra of $n \times n$ matrices, because the product of two upper triangular matrices is an upper triangular matrix, as can be easily verified.

A strictly upper triangular matrix is nilpotent. Let’s illustrate this for a 4×4 matrix. With

$$A = \begin{pmatrix} 0 & a_{12} & a_{13} & a_{14} \\ 0 & 0 & a_{23} & a_{24} \\ 0 & 0 & 0 & a_{34} \\ 0 & 0 & 0 & 0 \end{pmatrix},$$

⁷Recall that \mathcal{B}^k is the collection of products $\mathbf{a}_1 \dots \mathbf{a}_k$ of elements in \mathcal{B} .

it is easily seen that

$$A^2 = \begin{pmatrix} 0 & 0 & a_{12}a_{23} & a_{12}a_{24} + a_{13}a_{34} \\ 0 & 0 & 0 & a_{23}a_{34} \\ 0 & 0 & 0 & 0 \\ 0 & 0 & 0 & 0 \end{pmatrix},$$

$$A^3 = \begin{pmatrix} 0 & 0 & 0 & a_{12}a_{23}a_{34} \\ 0 & 0 & 0 & 0 \\ 0 & 0 & 0 & 0 \\ 0 & 0 & 0 & 0 \end{pmatrix},$$

and

$$A^4 = \begin{pmatrix} 0 & 0 & 0 & 0 \\ 0 & 0 & 0 & 0 \\ 0 & 0 & 0 & 0 \\ 0 & 0 & 0 & 0 \end{pmatrix}.$$

Thus, the strictly upper triangular 4×4 matrices are nilpotent of index 4. In fact, one can show that the *subalgebra* of the strictly upper triangular 4×4 matrices has index 4.

The reader can convince him/herself that strictly upper triangular $n \times n$ matrices are nilpotent of index n , and that the subalgebra of the strictly upper triangular $n \times n$ matrices is nilpotent of index n .

3.5.1 The Radical

Nilpotent subalgebras play a fundamental role in the classification of algebras. It is remarkable that all the left, right, and two-sided nilpotent ideals of an algebra are contained in a single nilpotent ideal, which we shall explore now.

Lemma 3.5.5 *Let \mathcal{L} and \mathcal{M} be two nilpotent left (right) ideals of the algebra \mathcal{A} . Let λ and μ be the indices of \mathcal{L} and \mathcal{M} , respectively. Then $\mathcal{L} + \mathcal{M}$ is a left (right) ideal of \mathcal{A} of index at most $\lambda + \mu - 1$.*

Proof We prove the Lemma for left ideals. Clearly, $\mathcal{L} + \mathcal{M}$ is a left ideal. Any element of $\mathcal{L} + \mathcal{M}$ raised to the k th power can be written as a linear combination of elements of the form $\mathbf{a}_1 \mathbf{a}_2 \dots \mathbf{a}_k$ with \mathbf{a}_i belonging to either \mathcal{L} or \mathcal{M} . Suppose that l terms of this product are in \mathcal{L} and m terms in \mathcal{M} . Let j be the largest integer such that $\mathbf{a}_j \in \mathcal{L}$. Starting with \mathbf{a}_j move to the left until you reach another element of \mathcal{L} , say \mathbf{a}_r . All the terms \mathbf{a}_{r+1} to \mathbf{a}_{j-1} are in \mathcal{M} . Since \mathcal{L} is a left ideal,

$$\underbrace{\mathbf{a}_{r+1} \dots \mathbf{a}_{j-1}}_{\in \mathcal{A}} \mathbf{a}_j \equiv \mathbf{a}'_j \in \mathcal{L}.$$

This contracts the product $\mathbf{a}_r \mathbf{a}_{r+1} \dots \mathbf{a}_{j-1} \mathbf{a}_j$ to $\mathbf{a}_r \mathbf{a}'_j$ with both factors in \mathcal{L} . Continuing this process, we obtain

$$\mathbf{a}_1 \mathbf{a}_2 \dots \mathbf{a}_k = \mathbf{b}_1 \mathbf{b}_2 \dots \mathbf{b}_l \mathbf{c}, \quad \mathbf{b}_i \in \mathcal{L}, \mathbf{c} \in \mathcal{M}.$$

Similarly,

$$\mathbf{a}_1 \mathbf{a}_2 \dots \mathbf{a}_k = \mathbf{c}_1 \mathbf{c}_2 \dots \mathbf{c}_m \mathbf{b}, \quad \mathbf{b} \in \mathcal{L}, \mathbf{c}_i \in \mathcal{M}.$$

Since $k = l + m$, if $k = \mu + \lambda - 1$, then $(\mu - m) + (\lambda - l) = 1$. This shows that if $m < \mu$, then $l \geq \lambda$ and if $l < \lambda$, then $m \geq \mu$. In either case, $\mathbf{a}_1 \dots \mathbf{a}_k = \mathbf{0}$, by one of the last two equations above. Hence, $\mathcal{L} + \mathcal{M}$ is nilpotent with an index of at most $\mu + \lambda - 1$. The proof for the right ideals is identical to this proof. \square

Lemma 3.5.6 *Let \mathcal{L} be a nilpotent left ideal of the algebra \mathcal{A} . Then the sum $\mathcal{J} = \mathcal{L} + \mathcal{L}\mathcal{A}$ is a nilpotent two-sided ideal.*

Proof Since \mathcal{L} is a left ideal, $\mathcal{A}\mathcal{L} \subseteq \mathcal{L}$. Therefore,

$$\mathcal{A}\mathcal{J} = \mathcal{A}\mathcal{L} + \mathcal{A}\mathcal{L}\mathcal{A} \subseteq \mathcal{L} + \mathcal{L}\mathcal{A} = \mathcal{J},$$

showing that \mathcal{J} is a left ideal. On the other hand,

$$\mathcal{J}\mathcal{A} = \mathcal{L}\mathcal{A} + \mathcal{L}\mathcal{A}\mathcal{A} \subseteq \mathcal{L}\mathcal{A} + \mathcal{L}\mathcal{A} = \mathcal{L}\mathcal{A} \subset \mathcal{J}$$

showing that \mathcal{J} is a right ideal.

Now consider a product of k elements of $\mathcal{L}\mathcal{A}$:

$$\mathbf{l}_1 \mathbf{a}_1 \mathbf{l}_2 \mathbf{a}_2 \dots \mathbf{l}_k \mathbf{a}_k = \mathbf{l}_1 \mathbf{l}'_2 \mathbf{l}'_3 \dots \mathbf{l}'_k \mathbf{a}_k, \quad \mathbf{l}_j \in \mathcal{L}, \mathbf{a}_j \in \mathcal{A}$$

where $\mathbf{l}'_i \equiv \mathbf{a}_{i-1} \mathbf{l}_i \in \mathcal{L}$. This shows that if k is equal to the index of \mathcal{L} , then the product is zero and hence, $\mathcal{L}\mathcal{A}$ is nilpotent. Note that since some of the \mathbf{a} 's may be in \mathcal{L} , the index of $\mathcal{L}\mathcal{A}$ is at most equal to the index of \mathcal{L} . Invoking Lemma 3.5.5 completes the proof. \square

The preceding two lemmas were introduced for the following:

Theorem 3.5.7 *There exists a unique nilpotent ideal in \mathcal{A} which contains every nilpotent left, right, and two-sided ideal of \mathcal{A} .*

Proof Let \mathcal{N} be a nilpotent ideal of maximum dimension. Let \mathcal{M} be any nilpotent ideal. By Lemma 3.5.5, $\mathcal{N} + \mathcal{M}$ is both a left and a right nilpotent ideal, hence, a nilpotent ideal. By assumption $\mathcal{N} + \mathcal{M} \subset \mathcal{N}$, and therefore, $\mathcal{M} \subset \mathcal{N}$, proving that \mathcal{N} contains all ideals. If there were another maximal ideal \mathcal{N}' , then $\mathcal{N}' \subset \mathcal{N}$ and $\mathcal{N} \subset \mathcal{N}'$, implying that $\mathcal{N}' = \mathcal{N}$, and that \mathcal{N} is unique.

If \mathcal{L} is a left nilpotent ideal, then by Lemma 3.5.6, $\mathcal{L} \subset \mathcal{J} = \mathcal{L} + \mathcal{L}\mathcal{A} \subset \mathcal{N}$, because \mathcal{J} is an ideal. Thus, \mathcal{N} contains all the nilpotent left ideals. Similarly, \mathcal{N} contains all the nilpotent right ideals. \square

radical of an algebra

Definition 3.5.8 The unique maximal ideal of an algebra \mathcal{A} guaranteed by Theorem 3.5.7 is called the **radical** of \mathcal{A} and denoted by $\text{Rad}(\mathcal{A})$.

We have seen that a nilpotent algebra cannot contain an idempotent. In fact, the reverse implication is also true. To show that, we need the following

Lemma 3.5.9 *Suppose that \mathcal{A} contains an element \mathbf{a} such that $\mathcal{A}\mathbf{a}^k = \mathcal{A}\mathbf{a}^{k-1}$ for some positive integer k . Then \mathcal{A} contains an idempotent.*

Proof Let $\mathcal{B} \equiv \mathcal{A}\mathbf{a}^{k-1}$. Then \mathcal{B} is a left ideal of \mathcal{A} satisfying $\mathcal{B}\mathbf{a} = \mathcal{B}$. Multiplying both sides by \mathbf{a} , we see that

$$\mathcal{B}\mathbf{a}^2 = \mathcal{B}\mathbf{a} = \mathcal{B}, \quad \mathcal{B}\mathbf{a}^3 = \mathcal{B}\mathbf{a} = \mathcal{B},$$

and $\mathcal{B}\mathbf{a}^k = \mathcal{B}$. But $\mathbf{a}^k \in \mathcal{B}$ because $\mathcal{B} \equiv \mathcal{A}\mathbf{a}^{k-1}$. Thus, with $\mathbf{b} = \mathbf{a}^k$, we get $\mathcal{B}\mathbf{b} = \mathcal{B}$. This means that there must exist an element $\mathbf{P} \in \mathcal{B}$ such that $\mathbf{P}\mathbf{b} = \mathbf{b}$, or $(\mathbf{P}^2 - \mathbf{P})\mathbf{b} = \mathbf{0}$. By Problem 3.32, $\mathbf{P}^2 = \mathbf{P}$. Hence, \mathcal{B} , and therefore \mathcal{A} has an idempotent. \square

Proposition 3.5.10 *An algebra is nilpotent if and only if it contains no idempotent.*

Proof The “only if” part was shown after Definition 3.5.1. We now show that if \mathcal{A} has no idempotent, then it must be nilpotent. To begin, we note that in general, $\mathcal{A}\mathbf{a} \subseteq \mathcal{A}$, and therefore, $\mathcal{A}\mathbf{a}^k \subseteq \mathcal{A}\mathbf{a}^{k-1}$ for all k . If \mathcal{A} has no idempotent, then the equality is ruled out by Lemma 3.5.9. Hence, $\mathcal{A}\mathbf{a}^k \subset \mathcal{A}\mathbf{a}^{k-1}$. This being true for all k , we have

$$\mathcal{A} \supset \mathcal{A}\mathbf{a} \supset \mathcal{A}\mathbf{a}^2 \supset \cdots \supset \mathcal{A}\mathbf{a}^k \supset \cdots$$

Since \mathcal{A} has a finite dimension, there must exist an integer r such that $\mathcal{A}\mathbf{a}^r = \{\mathbf{0}\}$ for all $\mathbf{a} \in \mathcal{A}$. In particular, $\mathbf{a}^{r+1} = \mathbf{0}$ for all $\mathbf{a} \in \mathcal{A}$. This shows that \mathcal{A} is nil, and by Theorem 3.5.3, nilpotent. \square

Let \mathbf{P} be an idempotent of \mathcal{A} . Consider $\mathcal{L}(\mathbf{P})$, the left annihilator of \mathbf{P} (see Example 3.2.2), and note that $(\mathbf{a} - \mathbf{a}\mathbf{P}) \in \mathcal{L}(\mathbf{P})$ for any $\mathbf{a} \in \mathcal{A}$. Furthermore, if $\mathbf{a} \in \mathcal{P}\mathcal{L}(\mathbf{P})$, then $\mathbf{a} = \mathbf{P}\mathbf{x}$ for some $\mathbf{x} \in \mathcal{L}(\mathbf{P})$. Thus, \mathbf{a} has the property that $\mathbf{P}\mathbf{a} = \mathbf{a}$ and $\mathbf{a}\mathbf{P} = \mathbf{0}$.

Similarly, consider $\mathcal{R}(\mathbf{P})$, the right annihilator of \mathbf{P} , and note that $(\mathbf{a} - \mathbf{P}\mathbf{a}) \in \mathcal{R}(\mathbf{P})$ for any $\mathbf{a} \in \mathcal{A}$. Furthermore, if $\mathbf{a} \in \mathcal{R}(\mathbf{P})\mathcal{P}$, then $\mathbf{a} = \mathbf{x}\mathbf{P}$ for some $\mathbf{x} \in \mathcal{R}(\mathbf{P})$. Thus, \mathbf{a} has the property that $\mathbf{a}\mathbf{P} = \mathbf{a}$ and $\mathbf{P}\mathbf{a} = \mathbf{0}$.

Let $\mathcal{J}(\mathbf{P}) = \mathcal{L}(\mathbf{P}) \cap \mathcal{R}(\mathbf{P})$. Then, clearly $\mathcal{J}(\mathbf{P})$ is a two-sided ideal consisting of elements $\mathbf{a} \in \mathcal{A}$ such that $\mathbf{a}\mathbf{P} = \mathbf{P}\mathbf{a} = \mathbf{0}$. To these, we add the subalgebra $\mathcal{P}\mathcal{A}\mathcal{P}$, whose elements \mathbf{a} can be shown to have the property $\mathbf{P}\mathbf{a} = \mathbf{a}\mathbf{P} = \mathbf{a}$.

We thus have

$$\begin{aligned}
 \mathbf{P}\mathcal{A}\mathbf{P} &= \{\mathbf{a} \in \mathcal{A} \mid \mathbf{P}\mathbf{a} = \mathbf{a}\mathbf{P} = \mathbf{a}\}, \\
 \mathbf{P}\mathcal{L}(\mathbf{P}) &= \{\mathbf{a} \in \mathcal{A} \mid \mathbf{P}\mathbf{a} = \mathbf{a}, \mathbf{a}\mathbf{P} = \mathbf{0}\}, \\
 \mathcal{R}(\mathbf{P})\mathbf{P} &= \{\mathbf{a} \in \mathcal{A} \mid \mathbf{a}\mathbf{P} = \mathbf{a}, \mathbf{P}\mathbf{a} = \mathbf{0}\}, \\
 \mathcal{J}(\mathbf{P}) &= \{\mathbf{a} \in \mathcal{A} \mid \mathbf{a}\mathbf{P} = \mathbf{P}\mathbf{a} = \mathbf{0}\},
 \end{aligned} \tag{3.13}$$

and the following

Theorem 3.5.11 *Let \mathcal{A} be any algebra with an idempotent \mathbf{P} . Then we have the Peirce decomposition of \mathcal{A} :*

Peirce decomposition

$$\mathcal{A} = \mathbf{P}\mathcal{A}\mathbf{P} \oplus_V \mathbf{P}\mathcal{L}(\mathbf{P}) \oplus_V \mathcal{R}(\mathbf{P})\mathbf{P} \oplus_V \mathcal{J}(\mathbf{P}),$$

where \oplus_V indicates a vector space direct sum, and each factor is a subalgebra.

Proof By Eq. (3.13), each summand is actually an algebra. Furthermore, it is not hard to show that the only vector common to any two of the summands is the zero vector. Thus the sum is indeed a direct sum of subspaces. Next note that for any $\mathbf{a} \in \mathcal{A}$,

$$\mathbf{a} = \mathbf{P}\mathbf{a}\mathbf{P} + \underbrace{\mathbf{P}(\mathbf{a} - \mathbf{a}\mathbf{P})}_{\in \mathcal{L}(\mathbf{P})} + \underbrace{(\mathbf{a} - \mathbf{P}\mathbf{a})\mathbf{P}}_{\in \mathcal{R}(\mathbf{P})} + \underbrace{(\mathbf{a} - \mathbf{P}\mathbf{a} - \mathbf{a}\mathbf{P} + \mathbf{P}\mathbf{a}\mathbf{P})}_{\in \mathcal{J}(\mathbf{P})}$$

Problem 3.33 provides the details of the proof. \square

Definition 3.5.12 An element $\mathbf{a} \in \mathcal{A}$ is **orthogonal** to an idempotent \mathbf{P} if $\mathbf{a}\mathbf{P} = \mathbf{P}\mathbf{a} = \mathbf{0}$. Thus $\mathcal{J}(\mathbf{P})$ houses such elements. An idempotent \mathbf{P} is called **principal** if $\mathcal{J}(\mathbf{P})$ contains no idempotent.

principal idempotent and elements orthogonal to an idempotent

Let \mathbf{P}_0 be an idempotent. If it is not principal, then $\mathcal{J}(\mathbf{P}_0)$ contains an idempotent \mathbf{q} . Let $\mathbf{P}_1 = \mathbf{P}_0 + \mathbf{q}$. Then using the fact that $\mathbf{P}_0\mathbf{q} = \mathbf{q}\mathbf{P}_0 = \mathbf{0}$, we can show that \mathbf{P}_1 is an idempotent and that

$$\mathbf{P}_1\mathbf{P}_0 = \mathbf{P}_0\mathbf{P}_1 = \mathbf{P}_0 \quad \text{and} \quad \mathbf{P}_1\mathbf{q} = \mathbf{q}\mathbf{P}_1 = \mathbf{q}. \tag{3.14}$$

If $\mathbf{x} \in \mathcal{J}(\mathbf{P}_1)$, then $\mathbf{x}\mathbf{P}_1 = \mathbf{P}_1\mathbf{x} = \mathbf{0}$, and the first equation in (3.14) gives $\mathbf{x}\mathbf{P}_0 = \mathbf{P}_0\mathbf{x} = \mathbf{0}$, i.e., $\mathbf{x} \in \mathcal{J}(\mathbf{P}_0)$, demonstrating that $\mathcal{J}(\mathbf{P}_1) \subseteq \mathcal{J}(\mathbf{P}_0)$. Since $\mathbf{q} \in \mathcal{J}(\mathbf{P}_0)$, but $\mathbf{q} \notin \mathcal{J}(\mathbf{P}_1)$, $\mathcal{J}(\mathbf{P}_1)$ is a proper subset of $\mathcal{J}(\mathbf{P}_0)$. If $\mathcal{J}(\mathbf{P}_1)$ is not principal, then $\mathcal{J}(\mathbf{P}_1)$ contains an idempotent \mathbf{r} . Let $\mathbf{P}_2 = \mathbf{P}_1 + \mathbf{r}$. Then \mathbf{P}_2 is an idempotent and, as before, $\mathcal{J}(\mathbf{P}_2)$ is a proper subset of $\mathcal{J}(\mathbf{P}_1)$. We continue this process and obtain

$$\mathcal{J}(\mathbf{P}_0) \supset \mathcal{J}(\mathbf{P}_1) \supset \mathcal{J}(\mathbf{P}_2) \supset \cdots \supset \mathcal{J}(\mathbf{P}_k) \supset \cdots .$$

However, we cannot continue this chain indefinitely, because $\mathcal{J}(\mathbf{P}_0)$ has finite dimension. This means that there is a positive integer n such that $\mathcal{J}(\mathbf{P}_n)$ has no idempotent, i.e., \mathbf{P}_n is principal. We have just proved

Proposition 3.5.13 *Every algebra that is not nilpotent has a principal idempotent.*

primitive idempotent **Definition 3.5.14** An idempotent is **primitive** if it is not the sum of two orthogonal idempotents.

Proposition 3.5.15 *\mathbf{P} is primitive if and only if it is the only idempotent of \mathbf{PAP} .*

Proof Suppose that \mathbf{P} is not primitive. Then there are orthogonal idempotents \mathbf{P}_1 and \mathbf{P}_2 such that $\mathbf{P} = \mathbf{P}_1 + \mathbf{P}_2$. It is easy to show that $\mathbf{P}\mathbf{P}_i = \mathbf{P}_i\mathbf{P} = \mathbf{P}_i$ for $i = 1, 2$. Hence, by the first equation in (3.13), $\mathbf{P}_i \in \mathbf{PAP}$, and \mathbf{P} is not the only idempotent of \mathbf{PAP} .

Conversely, suppose that \mathbf{P} is not the only idempotent in \mathbf{PAP} , so that \mathbf{PAP} contains another idempotent, say \mathbf{P}' . Then by the first equation in (3.13), $\mathbf{P}\mathbf{P}' = \mathbf{P}'\mathbf{P} = \mathbf{P}'$. This shows that

$$(\mathbf{P} - \mathbf{P}')\mathbf{P}' = \mathbf{P}'(\mathbf{P} - \mathbf{P}') = \mathbf{0} \quad \text{and} \quad (\mathbf{P} - \mathbf{P}')\mathbf{P} = \mathbf{P}(\mathbf{P} - \mathbf{P}') = \mathbf{P} - \mathbf{P}',$$

i.e., that $(\mathbf{P} - \mathbf{P}') \in \mathbf{PAP}$ and it is orthogonal to \mathbf{P}' . Furthermore, $\mathbf{P} = (\mathbf{P} - \mathbf{P}') + \mathbf{P}'$, i.e., \mathbf{P} is the sum of two primitive idempotents, and thus not primitive. \square

Let \mathbf{P} be an idempotent that is not primitive. Write $\mathbf{P} = \mathbf{P}_1 + \mathbf{Q}$, with \mathbf{P}_1 and \mathbf{Q} orthogonal. If either of the two, say \mathbf{Q} , is not primitive, write it as $\mathbf{Q} = \mathbf{P}_2 + \mathbf{P}_3$, with \mathbf{P}_2 and \mathbf{P}_3 orthogonal. By Problem 3.34, the set $\{\mathbf{P}_i\}_{i=1}^3$ are mutually orthogonal idempotents and $\mathbf{P} = \mathbf{P}_1 + \mathbf{P}_2 + \mathbf{P}_3$. We can continue this process until all \mathbf{P}_i s are primitive. Therefore, we have

Theorem 3.5.16 *Every idempotent of an algebra \mathcal{A} can be expressed as the sum of a finite number of mutually orthogonal primitive idempotents.*

3.5.2 Semi-simple Algebras

Algebras which have no nilpotent ideals play an important role in the classification of algebras.

semi-simple algebras

Definition 3.5.17 An algebra whose radical is zero is called **semi-simple**.

Since $\text{Rad}(\mathcal{A})$ contains all nilpotent left, right, and two-sided ideals of an algebra, if \mathcal{A} is semi-simple, it can have no nilpotent left, right, or two-sided ideals.

Proposition 3.5.18 *A simple algebra is semi-simple.*

Proof If the simple algebra \mathcal{A} is not semi-simple, then it has a nilpotent ideal. Since the only ideal is \mathcal{A} itself, we must show that \mathcal{A} is not nilpotent. Assume otherwise, and note that \mathcal{A}^2 is a *proper* ideal of \mathcal{A} , because if $\mathcal{A}^2 = \mathcal{A}$, then $\mathcal{A}^k = \mathcal{A}$ for any k . This contradicts our assumption that \mathcal{A} is nilpotent. Since the only ideals of \mathcal{A} are \mathcal{A} and $\{\mathbf{0}\}$, we must have $\mathcal{A}^2 = \{\mathbf{0}\}$. It then follows that any proper subspace of \mathcal{A} is trivially a nonzero proper ideal of \mathcal{A} , which cannot happen because of the simplicity of \mathcal{A} . \square

Lemma 3.5.19 *If \mathcal{A} is semi-simple and \mathbf{P} is any principal idempotent in \mathcal{A} , then $\mathcal{A} = \mathbf{P}\mathcal{A}\mathbf{P}$.*

Proof Since \mathcal{A} is not nilpotent, it has a principal idempotent \mathbf{P} by Proposition 3.5.13. Since \mathbf{P} is principal, $\mathcal{J}(\mathbf{P})$ of Theorem 3.5.11 contains no idempotent and by Proposition 3.5.10 must be nilpotent. Since \mathcal{A} has no nilpotent ideal, $\mathcal{J}(\mathbf{P}) = \{\mathbf{0}\}$. Now note that $\mathcal{R}(\mathbf{P})\mathcal{L}(\mathbf{P})$ of Theorem 3.5.11 consists of all elements annihilated by both the right and left multiplication by \mathbf{P} . Therefore, $\mathcal{R}(\mathbf{P})\mathcal{L}(\mathbf{P})$ is a subset of $\mathcal{J}(\mathbf{P})$. Hence, $\mathcal{R}(\mathbf{P})\mathcal{L}(\mathbf{P}) = \{\mathbf{0}\}$. This shows that if $\mathbf{r} \in \mathcal{R}(\mathbf{P})$ and $\mathbf{l} \in \mathcal{L}(\mathbf{P})$, then $\mathbf{r}\mathbf{l} = \mathbf{0}$. On the other hand, for any $\mathbf{l} \in \mathcal{L}(\mathbf{P})$ and $\mathbf{r} \in \mathcal{R}(\mathbf{P})$, we have

$$(\mathbf{l}\mathbf{r})^2 = \mathbf{l} \underbrace{(\mathbf{r}\mathbf{l})}_{=\mathbf{0}} \mathbf{r} = \mathbf{0}.$$

It follows that the ideal $\mathcal{L}(\mathbf{P})\mathcal{R}(\mathbf{P})$ (see Problem 3.10) is nil of index 2, and by Theorem 3.5.3, it is nilpotent. The semi-simplicity of \mathcal{A} implies that $\mathcal{L}(\mathbf{P})\mathcal{R}(\mathbf{P}) = \{\mathbf{0}\}$. Multiplying the Peirce decomposition on the left by $\mathcal{L}(\mathbf{P})$, and using these results and the fact that $\mathcal{L}(\mathbf{P})\mathbf{P} = \{\mathbf{0}\}$, we obtain

$$\mathcal{L}(\mathbf{P})\mathcal{A} = \mathcal{L}(\mathbf{P})\mathcal{R}(\mathbf{P})\mathbf{P} = \{\mathbf{0}\}.$$

In particular $\mathcal{L}(\mathbf{P})\mathcal{L}(\mathbf{P}) = \{\mathbf{0}\}$, and thus $\mathcal{L}(\mathbf{P})$ is nilpotent, hence zero. Similarly, $\mathcal{R}(\mathbf{P})$ is also zero. Therefore, the Peirce decomposition of \mathcal{A} reduces to the first term. \square

Theorem 3.5.20 *A semi-simple algebra \mathcal{A} is necessarily unital. Furthermore, the unit is the only principal idempotent of \mathcal{A} .*

semi-simple algebras are unital

Proof Let \mathbf{P} be a principal idempotent of \mathcal{A} . If $\mathbf{b} \in \mathcal{A}$, then by Lemma 3.5.19 $\mathbf{b} \in \mathbf{P}\mathcal{A}\mathbf{P}$, and $\mathbf{b} = \mathbf{P}\mathbf{a}\mathbf{P}$ for some $\mathbf{a} \in \mathcal{A}$. Therefore,

$$\begin{aligned} \mathbf{P}\mathbf{b} &= \mathbf{P}^2\mathbf{a}\mathbf{P} = \mathbf{P}\mathbf{a}\mathbf{P} = \mathbf{b} \\ \mathbf{b}\mathbf{P} &= \mathbf{P}\mathbf{a}\mathbf{P}^2 = \mathbf{P}\mathbf{a}\mathbf{P} = \mathbf{b}. \end{aligned}$$

Since this holds for all $\mathbf{b} \in \mathcal{A}$, we conclude that \mathbf{P} is the identity of \mathcal{A} . \square

Idempotents preserve the semi-simplicity of algebras in the following sense:

Proposition 3.5.21 *If \mathcal{A} is semi-simple, then $\mathbf{P}\mathcal{A}\mathbf{P}$ is also semi-simple for any idempotent $\mathbf{P} \in \mathcal{A}$.*

Proof Let $\mathcal{N} = \text{Rad}(\mathbf{P}\mathcal{A}\mathbf{P})$ and $\mathbf{x} \in \mathcal{N} \subset \mathbf{P}\mathcal{A}\mathbf{P}$. Construct the left ideal $\mathcal{A}\mathbf{x}$ in \mathcal{A} and note that by Eq. (3.13), $\mathbf{x}\mathbf{P} = \mathbf{P}\mathbf{x} = \mathbf{x}$. Then we have the following set identities:

$$\begin{aligned} (\mathcal{A}\mathbf{x})^{\nu+1} &= \mathcal{A}\mathbf{x}\mathcal{A}\mathbf{x} \dots \mathcal{A}\mathbf{x}\mathcal{A}\mathbf{x} = \mathcal{A}\mathbf{x}\mathbf{P}\mathcal{A}\mathbf{P}\mathbf{x} \dots \mathbf{P}\mathcal{A}\mathbf{P}\mathbf{x}\mathcal{A}\mathbf{P}\mathbf{x} \\ &= \mathcal{A}\mathbf{x}(\mathbf{P}\mathcal{A}\mathbf{P}\mathbf{x})^{\nu}. \end{aligned}$$

Since \mathcal{N} is an ideal in $\mathbf{P}\mathcal{A}\mathbf{P}$, we have $\mathbf{P}\mathcal{A}\mathbf{P}\mathbf{x} \subset \mathcal{N}$, and if ν is the index of \mathcal{N} , then $(\mathbf{P}\mathcal{A}\mathbf{P}\mathbf{x})^{\nu} = \{\mathbf{0}\}$. Thus, $\mathcal{A}\mathbf{x}$ is nilpotent. Since \mathcal{A} is semi-simple, we must have $\mathcal{A}\mathbf{x} = \{\mathbf{0}\}$. Thus, for any nonzero $\mathbf{a} \in \mathcal{A}$, $\mathbf{a}\mathbf{x} = \mathbf{0}$. In particular, $\mathbf{P}\mathbf{x} = \mathbf{x} = \mathbf{0}$. Since \mathbf{x} was an arbitrary element of $\text{Rad}(\mathbf{P}\mathcal{A}\mathbf{P})$, we must have $\text{Rad}(\mathbf{P}\mathcal{A}\mathbf{P}) = \{\mathbf{0}\}$. Hence, $\mathbf{P}\mathcal{A}\mathbf{P}$ is semi-simple. \square

Proposition 3.5.22 *Let \mathcal{A} be a semi-simple algebra and \mathbf{P} an idempotent in \mathcal{A} . Then $\mathbf{P}\mathcal{A}\mathbf{P}$ is a division algebra if and only if \mathbf{P} is primitive.*

Proof Suppose that $\mathbf{P}\mathcal{A}\mathbf{P}$ is a division algebra. By Proposition 3.5.2, identity is the only idempotent of $\mathbf{P}\mathcal{A}\mathbf{P}$. But \mathbf{P} is the identity of $\mathbf{P}\mathcal{A}\mathbf{P}$. Hence, \mathbf{P} is the only idempotent of $\mathbf{P}\mathcal{A}\mathbf{P}$, and by Proposition 3.5.15 \mathbf{P} is primitive.

Conversely, assume that \mathbf{P} is primitive. Let $\mathbf{x} \in \mathbf{P}\mathcal{A}\mathbf{P}$ be nonzero. The left ideal $\mathcal{L} \equiv (\mathbf{P}\mathcal{A}\mathbf{P})\mathbf{x}$ cannot be nilpotent because $\mathbf{P}\mathcal{A}\mathbf{P}$ is semi-simple by Proposition 3.5.21. Hence, it must contain an idempotent by Proposition 3.5.13. But an idempotent in \mathcal{L} is an idempotent in $\mathbf{P}\mathcal{A}\mathbf{P}$. Proposition 3.5.15 identifies \mathbf{P} as the sole idempotent in $\mathbf{P}\mathcal{A}\mathbf{P}$, and thus, in \mathcal{L} . As an element of \mathcal{L} , we can write \mathbf{P} as $\mathbf{P} = \mathbf{a}\mathbf{x}$ with $\mathbf{a} \in \mathbf{P}\mathcal{A}\mathbf{P}$. Since, \mathbf{P} is the identity in $\mathbf{P}\mathcal{A}\mathbf{P}$, \mathbf{x} has an inverse. It follows that any element in $\mathbf{P}\mathcal{A}\mathbf{P}$ has an inverse. Thus it is a division algebra. \square

It is intuitively obvious that a simple algebra is somehow more fundamental than a semi-simple algebra. We have seen that a simple algebra is semi-simple. But the converse is of course not true. If simple algebras are more fundamental, then semi-simple algebras should be “built up” from simple ones. To see this we first need some preliminaries.

Lemma 3.5.23 *If \mathcal{A} has an ideal \mathcal{B} with unit $\mathbf{1}_B$, then $\mathcal{A} = \mathcal{B} \oplus \mathcal{J}(\mathbf{1}_B)$, where $\mathcal{J}(\mathbf{1}_B)$ is the ideal in the Peirce decomposition of \mathcal{A} .*

Proof Since $\mathbf{1}_B$ is an idempotent⁸ of \mathcal{A} , we can write the following Peirce decomposition:

$$\mathcal{A} = \mathbf{1}_B\mathcal{A}\mathbf{1}_B \oplus_V \mathbf{1}_B\mathcal{L}(\mathbf{1}_B) \oplus_V \mathcal{R}(\mathbf{1}_B)\mathbf{1}_B \oplus_V \mathcal{J}(\mathbf{1}_B) \equiv \mathcal{S}(\mathbf{1}_B) \oplus_V \mathcal{J}(\mathbf{1}_B)$$

⁸Note that $\mathbf{1}_B$ is *not* the identity of \mathcal{A} . It satisfies $\mathbf{x}\mathbf{1}_B = \mathbf{1}_B\mathbf{x} = \mathbf{x}$ only if $\mathbf{x} \in \mathcal{B}$.

where $\mathcal{S}(\mathbf{1}_B) = \mathbf{1}_B \mathcal{A} \mathbf{1}_B \oplus_V \mathbf{1}_B \mathcal{L}(\mathbf{1}_B) \oplus_V \mathcal{R}(\mathbf{1}_B) \mathbf{1}_B$. Since, \mathcal{B} is an ideal, each component of $\mathcal{S}(\mathbf{1}_B)$ is a subset of \mathcal{B} , and therefore, $\mathcal{S}(\mathbf{1}_B) \subseteq \mathcal{B}$. If $\mathbf{b} \in \mathcal{B}$, then $\mathbf{b} \in \mathcal{A}$, and by the above decomposition, $\mathbf{b} = \mathbf{b}_1 + \mathbf{b}_2$, with $\mathbf{b}_1 \in \mathcal{S}(\mathbf{1}_B)$ and $\mathbf{b}_2 \in \mathcal{J}(\mathbf{1}_B)$. Multiplying both sides by $\mathbf{1}_B$, we get

$$\mathbf{b} \mathbf{1}_B = \mathbf{b}_1 \mathbf{1}_B + \mathbf{b}_2 \mathbf{1}_B \quad \text{or} \quad \mathbf{b} = \mathbf{b}_1$$

because $\mathbf{1}_B$ is the identity in \mathcal{B} and $\mathcal{J}(\mathbf{1}_B)$ is orthogonal to $\mathbf{1}_B$. It follows that $\mathbf{b} \in \mathcal{S}(\mathbf{1}_B)$ and, therefore, $\mathcal{B} \subseteq \mathcal{S}(\mathbf{1}_B)$. Hence, $\mathcal{B} = \mathcal{S}(\mathbf{1}_B)$ and $\mathcal{A} = \mathcal{B} \oplus_V \mathcal{J}(\mathbf{1}_B)$. Since $\mathcal{J}(\mathbf{1}_B) \mathcal{B} = \mathcal{B} \mathcal{J}(\mathbf{1}_B) = \{\mathbf{0}\}$, we can change \oplus_V to \oplus . \square

Lemma 3.5.24 *A nonzero ideal of a semi-simple algebra is semi-simple.*

Proof Let \mathcal{A} be a semi-simple algebra and \mathcal{B} be a nonzero ideal of \mathcal{A} . Then $\mathcal{B} \text{Rad}(\mathcal{B}) \mathcal{B} \subset \text{Rad}(\mathcal{B})$ because $\text{Rad}(\mathcal{B})$ is an ideal in \mathcal{B} . Furthermore, since \mathcal{B} is an ideal in \mathcal{A} , $\mathcal{A} \mathcal{B} \subset \mathcal{B}$ and $\mathcal{B} \mathcal{A} \subset \mathcal{B}$. It follows that $\mathcal{A}(\mathcal{B} \text{Rad}(\mathcal{B}) \mathcal{B}) \mathcal{A} = (\mathcal{A} \mathcal{B}) \text{Rad}(\mathcal{B}) (\mathcal{B} \mathcal{A}) \subset \mathcal{B} \text{Rad}(\mathcal{B}) \mathcal{B}$, i.e., that $\mathcal{B} \text{Rad}(\mathcal{B}) \mathcal{B}$ is an ideal in \mathcal{A} . Furthermore, it is nilpotent because it is contained in $\text{Rad}(\mathcal{B})$. Semi-simplicity of \mathcal{A} implies that $\mathcal{B} \text{Rad}(\mathcal{B}) \mathcal{B} = \{\mathbf{0}\}$. Since $\text{Rad}(\mathcal{B}) \subset \mathcal{B}$, $\mathcal{A} \text{Rad}(\mathcal{B}) \mathcal{A} \subset \mathcal{B}$, and $\mathcal{A} \text{Rad}(\mathcal{B}) \mathcal{A} \text{Rad}(\mathcal{B}) \mathcal{A} \text{Rad}(\mathcal{B}) \mathcal{A} \subset \mathcal{B} \text{Rad}(\mathcal{B}) \mathcal{B}$. Now note that

$$\begin{aligned} (\mathcal{A} \text{Rad}(\mathcal{B}) \mathcal{A})^3 &= \mathcal{A} \text{Rad}(\mathcal{B}) \mathcal{A} \mathcal{A} \text{Rad}(\mathcal{B}) \mathcal{A} \mathcal{A} \text{Rad}(\mathcal{B}) \mathcal{A} \\ &\subset \mathcal{A} \text{Rad}(\mathcal{B}) \mathcal{A} \text{Rad}(\mathcal{B}) \mathcal{A} \text{Rad}(\mathcal{B}) \mathcal{A} \\ &\subset \mathcal{B} \text{Rad}(\mathcal{B}) \mathcal{B} = \{\mathbf{0}\}, \end{aligned}$$

indicating that $\mathcal{A} \text{Rad}(\mathcal{B}) \mathcal{A}$ is nilpotent. Since it is an ideal in \mathcal{A} , and \mathcal{A} is semi-simple, $\mathcal{A} \text{Rad}(\mathcal{B}) \mathcal{A} = \{\mathbf{0}\}$, and since \mathcal{A} has an identity by Theorem 3.5.20, $\text{Rad}(\mathcal{B}) = \{\mathbf{0}\}$, and \mathcal{B} is semi-simple. \square

Theorem 3.5.25 *An algebra is semi-simple iff it is the direct sum of simple algebras.*

Proof If the algebra \mathcal{A} is the direct sum of simple algebras, then by Proposition 3.2.11, the only ideals of \mathcal{A} are either direct sums of the components or contained in them. In either case, these ideals cannot be nilpotent because a simple algebra is semi-simple. Therefore, \mathcal{A} is semi-simple.

Conversely, assume that \mathcal{A} is semi-simple. If it has no proper ideal, then it is simple and therefore semi-simple, and we are done. So, suppose \mathcal{B} is a proper nonzero ideal of \mathcal{A} . By Lemma 3.5.24 \mathcal{B} is semi-simple, and by Theorem 3.5.20 \mathcal{B} has a unit $\mathbf{1}_B$. Invoking Lemma 3.5.23, we can write $\mathcal{A} = \mathcal{B} \oplus \mathcal{J}(\mathbf{1}_B)$. If either of the two components is not simple, we continue the process. \square

Theorem 3.5.26 *The reduction of a semi-simple algebra to simple subalgebras is unique up to an ordering of the components.*

Proof Let $\mathcal{A} = \mathcal{A}_1 \oplus \cdots \oplus \mathcal{A}_r$ with \mathcal{A}_i simple. The unit of \mathcal{A} is a sum of the units of the components: $\mathbf{1} = \mathbf{1}_1 + \cdots + \mathbf{1}_r$. Let $\mathcal{A}' = \mathcal{A}'_1 \oplus \cdots \oplus \mathcal{A}'_s$ be another reduction. Multiply both sides of the identity decomposition on the left by \mathcal{A}'_j to obtain

$$\mathcal{A}'_j = \mathcal{A}'_j \mathbf{1}_1 + \cdots + \mathcal{A}'_j \mathbf{1}_r \equiv \mathcal{A}'_{j1} + \cdots + \mathcal{A}'_{jr} = \sum_{i=1}^r \mathcal{A}'_{ji}.$$

Since $\mathbf{1}_i \in \mathcal{A}_i$, and \mathcal{A}_i is an ideal of \mathcal{A} , $\mathcal{A}'_{ji} \subset \mathcal{A}_i$. Since \mathcal{A}_i are disjoint, \mathcal{A}'_{ji} are disjoint. Since \mathcal{A}'_j is an ideal, $\mathcal{A}'_j \mathbf{1}_i$ is an algebra as can be easily verified. Furthermore, since $\mathbf{1}_i \mathbf{1}_k = \mathbf{0}$ for $i \neq k$, the sum is a direct sum of algebras. Hence, by Proposition 3.2.11, \mathcal{A}'_{ji} is an ideal, and since it is a subset of \mathcal{A}_i , it is a subideal of \mathcal{A}_i . The simplicity of \mathcal{A}_i implies that $\mathcal{A}'_{ji} = \mathcal{A}_i$ or $\mathcal{A}'_{ji} = \{\mathbf{0}\}$. Since \mathcal{A}'_j is simple, only one of its components is nonzero, and it is one of the \mathcal{A}_i . \square

3.5.3 Classification of Simple Algebras

Theorems 3.5.25 and 3.5.26 classify all the semi-simple algebras, i.e., algebras with zero radicals, in terms of simple algebras. Can a general algebra be written as its radical and a semi-simple algebra? It turns out that an algebra \mathcal{A} with nonzero radical $\text{Rad}(\mathcal{A})$ is the direct sum $\mathcal{A} = \text{Rad}(\mathcal{A}) \oplus (\mathcal{A}/\text{Rad}(\mathcal{A}))$, i.e., the radical plus the factor algebra modulo the radical. Since, in $\mathcal{A}/\text{Rad}(\mathcal{A})$, the radical has been “factored out” of \mathcal{A} , the quotient is indeed semi-simple. This result is known as **Wedderburn principal structure theorem**, and reduces the study of all algebras to that of simple algebras. Simple algebras can be further decomposed (for a proof, see [Benn 87, pp. 330–332]):

Wedderburn principal
structure theorem
Wedderburn
decomposition theorem

Theorem 3.5.27 (Wedderburn decomposition) *An algebra \mathcal{A} is simple if and only if*

$$\mathcal{A} \cong \mathcal{D} \otimes \mathcal{M}_n \cong \mathcal{M}_n(\mathcal{D}),$$

where \mathcal{D} is a division algebra and $\mathcal{M}_n(\mathcal{D})$ is a total matrix algebra over \mathcal{D} for some non-negative integer n . \mathcal{D} and $\mathcal{M}_n(\mathcal{D})$ are unique up to a similarity transformation.

Denote by \mathcal{Z}_n the center of \mathcal{M}_n . Since \mathcal{M}_n is central, by Theorem 3.3.2, $\mathcal{Z}_n = \text{Span}\{\mathbf{1}_n\}$. On the other hand, Eq. (3.8) gives

$$\mathcal{Z}(\mathcal{A}) = \mathcal{Z}(\mathcal{D}) \otimes \mathcal{Z}_n \cong \mathcal{Z}(\mathcal{D}), \quad (3.15)$$

which is a relation that determines \mathcal{D} from a knowledge of the center of the algebra \mathcal{A} .

Proposition 3.5.28 *The only division algebra over \mathbb{C} is \mathbb{C} itself.*

Proof Let \mathcal{D} be a division algebra over \mathbb{C} and \mathbf{x} a nonzero element of \mathcal{D} . Since \mathcal{D} is finite-dimensional, there must exist a polynomial in \mathbf{x} such that (why?)

$$f(\mathbf{x}) = \mathbf{x}^n + \alpha_{n-1}\mathbf{x}^{n-1} + \cdots + \alpha_1\mathbf{x} + \alpha_0\mathbf{1} = \mathbf{0}.$$

Let n be the smallest integer such that this holds. By the fundamental theorem of algebra (see Sect. 10.5), $f(\mathbf{x})$ has at least one root λ . Then we have

$$f(\mathbf{x}) = (\mathbf{x} - \lambda\mathbf{1})g(\mathbf{x}) = \mathbf{0}.$$

Now, $g(\mathbf{x})$ has degree at most $n - 1$ and by assumption cannot be zero. Hence, it has an inverse because \mathcal{D} is a division algebra. Therefore, $\mathbf{x} - \lambda\mathbf{1} = \mathbf{0}$, and every element of \mathcal{D} is a multiple of $\mathbf{1}$. This completes the proof. \square

Proposition 3.5.28 and Theorem 3.5.27, plus the fact that $\mathcal{M}_n(\mathbb{C})$ is central (Theorem 3.3.2) give the following:

Theorem 3.5.29 *Any simple algebra \mathcal{A} over \mathbb{C} is isomorphic to $\mathcal{M}_n(\mathbb{C})$ for some n , and therefore \mathcal{A} is necessarily central simple.*

The centrality of a complex algebra can also be deduced from Eq. (3.15) and Proposition 3.5.28.

There is a theorem in abstract algebra, called the **Frobenius Theorem**, which states that the only division algebras over \mathbb{R} are \mathbb{R} , \mathbb{C} , and \mathbb{H} , and since the tensor product of two division algebras is a division algebra, also $\mathbb{C} \otimes \mathbb{H}$.⁹ Furthermore, the center of \mathbb{C} is the entire \mathbb{C} , because it is a commutative algebra. On the other hand, \mathbb{H} is central, i.e., its center is the span of its identity (reader, please verify), therefore, isomorphic to \mathbb{R} . Frobenius Theorem

Now consider a simple algebra \mathcal{A} over \mathbb{R} . If \mathcal{A} is central, i.e., if $\mathcal{Z}(\mathcal{A}) = \mathbb{R}$, then Eq. (3.15) yields

$$\mathbb{R} \cong \mathcal{Z}(\mathcal{D}) \Rightarrow \mathcal{D} = \mathbb{R} \text{ or } \mathbb{H}.$$

If $\mathcal{Z}(\mathcal{A}) = \mathbb{C}$, then

$$\mathbb{C} \cong \mathcal{Z}(\mathcal{D}) \Rightarrow \mathcal{D} = \mathbb{C} \text{ or } \mathbb{C} \otimes \mathbb{H}.$$

These results, plus the theorems of Frobenius and Wedderburn yield

⁹Since \mathbb{C} is a subalgebra of \mathbb{H} , the tensor product is actually redundant. However, in the classification of the Clifford algebras discussed later in the book, \mathbb{C} is sometimes explicitly factored out.

Theorem 3.5.30 Any simple algebra \mathcal{A} over \mathbb{R} is isomorphic to $\mathcal{D} \otimes \mathcal{M}_n$ for some n . If the center of \mathcal{A} is isomorphic to \mathbb{C} , then \mathcal{D} is either \mathbb{C} or $\mathbb{C} \otimes \mathbb{H}$. If \mathcal{A} is central (i.e., its center is isomorphic to \mathbb{R}), then \mathcal{D} is \mathbb{R} or \mathbb{H} .

We conclude our discussion of the decomposition of an algebra by a further characterization of a simple algebra and the connection between primitive idempotents and minimal left ideals.

Definition 3.5.31 Two idempotents \mathbf{P} and \mathbf{P}' of an algebra \mathcal{A} are called similar idempotents **similar** if there exists an invertible element $\mathbf{s} \in \mathcal{A}$ such that $\mathbf{P}' = \mathbf{s}\mathbf{P}\mathbf{s}^{-1}$.

The proof of the following theorem can be found in [Benn 87, pp. 332–334]:

Theorem 3.5.32 If \mathbf{P} is an idempotent of a simple algebra \mathcal{A} , then there exist mutually orthogonal primitive idempotents $\{\mathbf{P}_i\}_{i=1}^r$ such that $\mathbf{P} = \sum_{i=1}^r \mathbf{P}_i$. The integer r is unique and is called the **rank** of \mathbf{P} . Two idempotents are similar if and only if they have the same rank.

Theorem 3.5.33 Let \mathbf{P} be a primitive idempotent of a semi-simple algebra \mathcal{A} . Then $\mathcal{A}\mathbf{P}$ (respectively $\mathbf{P}\mathcal{A}$) is a minimal left (respectively right) ideal of \mathcal{A} .

Proof Since a semi-simple algebra is a direct sum of simple algebras each independent of the others, without loss of generality, we can assume that \mathcal{A} is simple. Suppose $\mathcal{L} \equiv \mathcal{A}\mathbf{P}$ is not minimal. Then \mathcal{L} contains a nonzero left ideal \mathcal{L}_1 of \mathcal{A} . Since \mathcal{A} is (semi-)simple, \mathcal{L}_1 is not nilpotent. Hence by Proposition 3.5.10 it contains an idempotent \mathbf{P}_1 . If $\mathbf{P}_1 = \mathbf{P}$, then

$$\mathcal{L} = \mathcal{A}\mathbf{P} = \mathcal{A}\mathbf{P}_1 \subseteq \mathcal{L}_1,$$

and therefore $\mathcal{L} = \mathcal{L}_1$, and we are done. So suppose that $\mathbf{P}_1 \neq \mathbf{P}$. Then, by Theorem 3.5.16

$$\mathbf{P}_1 = \mathbf{Q}_1 + \cdots + \mathbf{Q}_r,$$

where \mathbf{Q}_i are all primitive and orthogonal to each other. Since \mathbf{Q}_1 and \mathbf{P} have rank 1, by Theorem 3.5.32 they are similar, i.e., there exists an invertible element $\mathbf{s} \in \mathcal{A}$ such that $\mathbf{P} = \mathbf{s}\mathbf{Q}_1\mathbf{s}^{-1}$. So, by choosing $\mathbf{s}\mathbf{P}_1\mathbf{s}^{-1}$ instead of \mathbf{P}_1 if we have to,¹⁰ we can assume that $\mathbf{Q}_1 = \mathbf{P}$. Then

$$\mathbf{P}_1 = \mathbf{P} + \mathbf{Q}_2 + \cdots + \mathbf{Q}_r,$$

¹⁰This is equivalent to replacing \mathcal{L} with $\mathbf{s}\mathcal{L}\mathbf{s}^{-1}$, which is allowed by Theorem 3.2.7 and the non-uniqueness clause of Theorem 3.5.27.

and \mathbf{P} is orthogonal to all the \mathbf{Q}_i . Multiplying both sides on the left by \mathbf{P} , we get $\mathbf{PP}_1 = \mathbf{P}$ and

$$\mathcal{L} = \mathcal{A}\mathbf{P} = \mathcal{A}\mathbf{P}\mathbf{P}_1 \subseteq \mathcal{L}_1,$$

implying that $\mathcal{L} = \mathcal{L}_1$. The case of a right ideal follows similarly. □

3.6 Polynomial Algebra

Let \mathcal{A} be an associative algebra with identity $\mathbf{1}$. For any fixed element $\mathbf{a} \in \mathcal{A}$, consider the set $\mathcal{P}[\mathbf{a}]$ of elements of the algebra of the form

$$p(\mathbf{a}) \equiv \sum_{k=0}^{\infty} \alpha_k \mathbf{a}^k, \quad \alpha_k \in \mathbb{C},$$

in which only a finite number of the terms in the sum are nonzero. These are clearly polynomials in \mathbf{a} for which addition and multiplication is defined as usual.

Definition 3.6.1 Let \mathcal{A} be an associative algebra with identity $\mathbf{1}$. For any fixed element $\mathbf{a} \in \mathcal{A}$, the set $\mathcal{P}[\mathbf{a}]$ is a commutative algebra with identity called the **polynomial algebra** generated by \mathbf{a} . The coefficient of the highest power of \mathbf{a} in $p(\mathbf{a}) = \sum_{k=0}^{\infty} \alpha_k \mathbf{a}^k$ is called the **leading coefficient** of p , and α_0 is called the **scalar term**. A polynomial with leading coefficient 1 is called **monic**. The highest power of \mathbf{a} in p is called the **degree** of p and denoted by $\deg p$. A nonzero polynomial of the form $\alpha_n \mathbf{a}^n$ is called a **monomial** of degree n . leading coefficient,
monic, degree,
monomial

It is clear that $\{\mathbf{a}^k\}_{k=0}^{\infty}$ is a basis of the polynomial algebra $\mathcal{P}[\mathbf{a}]$.

If $p(\mathbf{a}) \equiv \sum_{k=0}^{\infty} \alpha_k \mathbf{a}^k$ and $q(\mathbf{a}) \equiv \sum_{j=0}^{\infty} \beta_j \mathbf{a}^j$, then

$$(p + q)(\mathbf{a}) = \sum_{k=0}^{\infty} (\alpha_k + \beta_k) \mathbf{a}^k,$$

$$(pq)(\mathbf{a}) = \sum_{i=0}^{\infty} \gamma_i \mathbf{a}^i, \quad \text{where } \gamma_i = \sum_{j+k=i} \alpha_k \beta_j.$$

Consider two nonzero polynomials $p(\mathbf{a})$ and $q(\mathbf{a})$. Then obviously

$$\begin{aligned} \deg(p + q) &\leq \max(\deg p, \deg q), \\ \deg(pq) &= \deg p + \deg q. \end{aligned} \tag{3.16}$$

Definition 3.6.2 The linear map $\mathbf{d} : \mathcal{P}[\mathbf{a}] \rightarrow \mathcal{P}[\mathbf{a}]$ defined by differentiation map

$$\begin{aligned} \mathbf{d}\mathbf{a}^k &= k\mathbf{a}^{k-1}, \quad k \geq 1 \\ \mathbf{d}\mathbf{a}^0 &\equiv \mathbf{d}\mathbf{1} = 0 \end{aligned}$$

is called the **differentiation map** in $\mathcal{P}[\mathbf{a}]$.

Theorem 3.6.3 *The differentiation map \mathbf{d} is a derivation of $\mathcal{P}[\mathbf{a}]$. We denote $\mathbf{d}(p)$ by p' .*

Proof The simple proof is left as Problem 3.35. □

Let p and q be two polynomials. Then $\mathbf{d}(pq) = \mathbf{d}(p)q + p\mathbf{d}(q)$, and in particular

$$\mathbf{d}(q^2) = 2q\mathbf{d}(q),$$

and in general

$$\mathbf{d}(q^k) = kq^{k-1}\mathbf{d}(q), \quad k \geq 1 \quad \text{and} \quad \mathbf{d}(q^0) = 0.$$

Because q is an element of \mathcal{A} , it can generate a polynomial in itself. We can construct, for example $p(q)$, by replacing \mathbf{a} with q :

$$p(q) = \sum_{k=0}^{\infty} \alpha_k q^k.$$

Then, it is straightforward to show that (see Problem 3.36)

$$\mathbf{d}(p(q)) = p'(q) \cdot q' \tag{3.17}$$

chain rule This is the **chain rule** for the differentiation of polynomials.

Definition 3.6.4 The polynomial $\mathbf{d}^r(p)$ is called the **r th derivative** of p and denoted by $p^{(r)}$. We extend the notation by defining $p^{(0)} = p$.

It is clear that $p^{(r)} = 0$ if $r > \deg(p)$.

Consider the monomial \mathbf{a}^n , and note that

$$\mathbf{d}^r(\mathbf{a}^n) = \frac{n!}{(n-r)!} \mathbf{a}^{n-r} \quad \text{or} \quad \mathbf{a}^{n-r} = \frac{(n-r)!}{n!} \mathbf{d}^r(\mathbf{a}^n).$$

Now use the binomial theorem to write

$$(\mathbf{a} + \mathbf{b})^n = \sum_{r=0}^n \binom{n}{r} \mathbf{a}^{n-r} \cdot \mathbf{b}^r = \sum_{r=0}^n \frac{1}{r!} \mathbf{d}^r(\mathbf{a}^n) \cdot \mathbf{b}^r.$$

Taylor formula The left-hand side is an arbitrary term of the polynomial $p(\mathbf{a} + \mathbf{b})$. Therefore, taking linear combination of such terms, we have

$$p(\mathbf{a} + \mathbf{b}) = \sum_{r=0}^n \frac{p^{(r)}(\mathbf{a})}{r!} \cdot \mathbf{b}^r. \tag{3.18}$$

This is called the **Taylor formula** for p .

A root of the polynomial $p(\mathbf{a}) = \sum_{k=0}^n \eta_k \mathbf{a}^k$ of degree n is a scalar $\lambda \in \mathbb{C}$ such that $p(\lambda) = \sum_{k=0}^n \eta_k \lambda^k = 0$. The fundamental theorem of algebra¹¹ states that \mathbb{C} is algebraically closed, meaning that any polynomial with coefficients in \mathbb{C} can be factored out into a product of polynomials of degree

¹¹A proof of the theorem can be found in Sect. 10.5.

one with coefficients in \mathbb{C} :

\mathbb{C} is algebraically closed

$$p(\mathbf{a}) = \eta_n (\mathbf{a} - \lambda_1 \mathbf{1})^{k_1} \dots (\mathbf{a} - \lambda_s \mathbf{1})^{k_s}, \quad (3.19)$$

where $\eta_n \neq 0$, $\{\lambda_i\}_{i=1}^s$ are the distinct complex roots of the polynomial, k_i , called the **multiplicity** of λ_i , is a nonnegative integer, and $\sum_{i=1}^s k_i = n$.

multiplicity of a root

As the simple example $p(\mathbf{a}) = \mathbf{a}^2 + \mathbf{1}$ suggests, \mathbb{R} is not algebraically closed. Nevertheless, a real polynomial can still be factored out into products of polynomials of degree 1 and 2 with real coefficients. To show this, first note that if λ is a complex root of a real polynomial, then its complex conjugate $\bar{\lambda}$ is also a root. This follows from taking the complex conjugate of $\sum_{k=0}^n \eta_k \lambda^k = 0$ and noting that $\bar{\eta}_k = \eta_k$ for real η_k . Furthermore, λ and $\bar{\lambda}$ must have the same multiplicity, otherwise the unmatched factors produce a polynomial with complex coefficients, which, when multiplied out with the rest of the factors, produce some complex coefficients for $p(\mathbf{a})$.

Next, multiply each factor in Eq. (3.19) containing a complex root by its complex conjugate. So, if $\lambda_m = \gamma_m + i\xi_m$, then

$$\begin{aligned} (\mathbf{a} - \lambda_m \mathbf{1})^{k_m} (\mathbf{a} - \bar{\lambda}_m \mathbf{1})^{k_m} &= (\mathbf{a} - \gamma_m \mathbf{1} - i\xi_m \mathbf{1})^{k_m} (\mathbf{a} - \gamma_m \mathbf{1} + i\xi_m \mathbf{1})^{k_m} \\ &= (\mathbf{a}^2 - 2\gamma_m \mathbf{a} + \gamma_m^2 \mathbf{1} + \xi_m^2 \mathbf{1})^{k_m} \\ &\equiv (\mathbf{a}^2 + \alpha_m \mathbf{a} + \beta_m \mathbf{1})^{k_m}, \quad \alpha_m^2 < 4\beta_m. \end{aligned}$$

The inequality ensures that $\xi_m \neq 0$, i.e., that the root is not real. We have just proved the following:

Theorem 3.6.5 *A real polynomial $p(\mathbf{a}) = \sum_{k=0}^n \eta_k \mathbf{a}^k$ of degree n has the following factorization:*

$$p(\mathbf{a}) = \eta_n \prod_{i=1}^r (\mathbf{a} - \lambda_i \mathbf{1})^{k_i} \prod_{j=1}^R (\mathbf{a}^2 + \alpha_j \mathbf{a} + \beta_j \mathbf{1})^{K_j}, \quad \alpha_j^2 < 4\beta_j,$$

where $\lambda_i, \alpha_j, \beta_j \in \mathbb{R}$, $k_i, K_j \in \mathbb{N}$, λ_i are all distinct, the pairs (α_j, β_j) are all distinct, and $2 \sum_{j=1}^R K_j + \sum_{i=1}^r k_i = n$.

Corollary 3.6.6 *A real polynomial of odd degree has at least one real root.*

3.7 Problems

3.1 Show that

(a) the product on \mathbb{R}^2 defined by

$$(x_1, x_2)(y_1, y_2) = (x_1 y_1 - x_2 y_2, x_1 y_2 + x_2 y_1)$$

turns \mathbb{R}^2 into an associative and commutative algebra, and

(b) the cross product on \mathbb{R}^3 turns it into a nonassociative, noncommutative algebra.

3.2 Show that the center of an algebra is a subspace of that algebra. If the algebra is associative, then its center is a subalgebra.

3.3 Prove that \mathcal{A}^2 , the derived algebra of \mathcal{A} , is indeed an algebra.

3.4 Prove that the set \mathcal{A} of $n \times n$ matrices, with the product defined by Eq. (3.3), form a nonassociative noncommutative algebra.

3.5 Prove that the set \mathcal{A} of $n \times n$ upper triangular matrices, with the product defined by ordinary multiplication of matrices is an associative noncommutative algebra. Show that the same set with multiplication defined by Eq. (3.3), is a nonassociative noncommutative algebra, and that the derived algebra $\mathcal{A}^2 \equiv \mathcal{B}$ is the set of strictly upper triangular matrices. What is the derived algebra \mathcal{B}^2 of \mathcal{B} ?

3.6 Prove Proposition 3.1.23.

3.7 Let $\omega \in \mathcal{L}(\mathcal{V})$ be defined by $\omega(\mathbf{a}) = -\mathbf{a}$ for all $\mathbf{a} \in \mathcal{V}$. Is ω an involution of \mathcal{V} ? Now suppose that \mathcal{V} is an algebra. Is ω so defined an involution of the algebra \mathcal{V} ? Recall that an involution of an algebra must be a *homomorphism* of that algebra.

3.8 Show that no *proper* left (right) ideal of an algebra with identity can contain an element that has a left (right) inverse.

3.9 Let \mathcal{A} be an associative algebra, and $\mathbf{x} \in \mathcal{A}$. Show that $\mathcal{A}\mathbf{x}$ is a left ideal, $\mathbf{x}\mathcal{A}$ is a right ideal, and $\mathcal{A}\mathbf{x}\mathcal{A}$ is a two-sided ideal.

3.10 Let \mathcal{L} be a left ideal and \mathcal{R} a right ideal. Show that $\mathcal{L}\mathcal{R}$ is a two-sided ideal.

3.11 Show that Φ of Theorem 3.1.25 is an algebra isomorphism.

3.12 Show that the linear transformation of Example 3.1.18 is an isomorphism of the two algebras \mathcal{A} and \mathcal{B} .

3.13 Let \mathcal{A} be an algebra with identity $\mathbf{1}_A$ and ϕ an epimorphism of \mathcal{A} onto another algebra \mathcal{B} . Show that $\phi(\mathbf{1}_A)$ is the identity of \mathcal{B} .

3.14 Show that the derived algebra of \mathcal{A} is an ideal in \mathcal{A} .

3.15 Show that the algebra of quaternions is central.

3.16 Write down all the structure constants for the algebra of quaternions. Show that this algebra is associative.

3.17 Show that a quaternion is pure iff its square is a nonpositive real number.

3.18 Let p and q be two quaternions. Show that

- (a) $(pq)^* = q^*p^*$,
- (b) $q \in \mathbb{R}$ iff $q^* = q$, and $q \in \mathbb{R}^3$ iff $q^* = -q$, and
- (c) $qq^* = q^*q$ is a nonnegative real number.

3.19 Prove Eq. (3.7).

3.20 Show that $\bar{\phi}$ of Example 3.2.16 is an algebra homomorphism.

3.21 Prove Theorem 3.3.2.

3.22 The algebra \mathcal{A} has a basis $\{\mathbf{1}, \mathbf{e}\}$ with $\mathbf{e}^2 = \mathbf{1}$.

- (a) Show that $\{\mathbf{f}_1, \mathbf{f}_2\}$ with $\mathbf{f}_1 = \frac{1}{2}(\mathbf{1} + \mathbf{e})$ and $\mathbf{f}_2 = \frac{1}{2}(\mathbf{1} - \mathbf{e})$ is also a basis.
- (b) Show that $\mathcal{A} = \mathcal{L}_1 \oplus_V \mathcal{L}_2$, where $\mathcal{L}_i = \mathcal{A}\mathbf{f}_i$, $i = 1, 2$ and \oplus_V indicates a vector space direct sum.
- (c) Show that \mathcal{L}_1 and \mathcal{L}_2 are actually two-sided ideals and that $\mathcal{L}_1\mathcal{L}_2 = \{\mathbf{0}\}$. Therefore, $\mathcal{A} = \mathcal{L}_1 \oplus \mathcal{L}_2$.
- (d) Multiply an arbitrary element of \mathcal{L}_i , $i = 1, 2$, by an arbitrary element of \mathcal{A} to show that $\mathcal{L}_i = \text{Span}\{\mathbf{f}_i\}$, $i = 1, 2$. Thus, $\mathcal{L}_i \cong \mathbb{R}$, $i = 1, 2$, or $\mathcal{A} = \mathbb{R} \oplus \mathbb{R}$.

3.23 If \mathcal{A} is an algebra and \mathbf{D} is a derivation in \mathcal{A} , prove that both the center $\mathcal{Z}(\mathcal{A})$ and the derived algebra \mathcal{A}^2 are stable under \mathbf{D} , i.e., if $\mathbf{a} \in \mathcal{Z}(\mathcal{A})$ then $\mathbf{D}(\mathbf{a}) \in \mathcal{Z}(\mathcal{A})$, and if $\mathbf{a} \in \mathcal{A}^2$ then $\mathbf{D}(\mathbf{a}) \in \mathcal{A}^2$.

3.24 Let $\mathbf{D} : \mathcal{A} \rightarrow \mathcal{A}$ be a derivation. Show that $\ker \mathbf{D}$ is a subalgebra of \mathcal{A} .

3.25 Show that a linear combination of two derivations is a derivation.

3.26 Fix a vector $\mathbf{a} \in \mathbb{R}^3$ and define the linear transformation $\mathbf{D}_\mathbf{a} : \mathbb{R}^3 \rightarrow \mathbb{R}^3$ by $\mathbf{D}_\mathbf{a}(\mathbf{b}) = \mathbf{a} \times \mathbf{b}$. Show that $\mathbf{D}_\mathbf{a}$ is a derivation of \mathbb{R}^3 with the cross product as multiplication.

3.27 Show that \mathbf{D} defined on $\mathcal{C}^r(a, b)$ by $\mathbf{D}(f) = f'(c)$, where $a < c < b$, is a ϕ_c -derivation if ϕ_c is defined as the evaluation map $\phi_c(f) = f(c)$.

3.28 Let $\mathbf{\Omega} \in \text{End}(\mathcal{A})$ be an antiderivation of \mathcal{A} with respect to ω . Show that $\ker \mathbf{\Omega}$ is a subalgebra of \mathcal{A} and $\mathbf{\Omega}(\mathbf{e}) = \mathbf{0}$ if \mathcal{A} has an identity.

3.29 Derive the Leibniz formula (3.11).

3.30 Prove Theorem 3.4.10.

3.31 Show that the algebra of the strictly upper triangular $n \times n$ matrices is nilpotent of index n .

3.32 Let \mathbf{b} be a fixed element of an algebra \mathcal{B} . Consider the linear transformation $\mathbf{T}_\mathbf{b} : \mathcal{B} \rightarrow \mathcal{B}$ given by $\mathbf{T}_\mathbf{b}(\mathbf{x}) = \mathbf{x}\mathbf{b}$. Using the dimension theorem, show that if $\mathcal{B}\mathbf{b} = \mathcal{B}$, then $\ker \mathbf{T}_\mathbf{b} = \mathbf{0}$.

3.33 Let \mathcal{A} be an algebra with an idempotent \mathbf{P} . Show that $\mathbf{P}\mathcal{A}\mathbf{P}$ consists of elements \mathbf{a} such that $\mathbf{a}\mathbf{P} = \mathbf{P}\mathbf{a} = \mathbf{a}$. For the subspaces of Theorem 3.5.11, let $\mathcal{A}_1 \equiv \mathbf{P}\mathcal{A}\mathbf{P}$, $\mathcal{A}_2 \equiv \mathbf{P}\mathcal{L}(\mathbf{P})$, $\mathcal{A}_3 \equiv \mathcal{R}(\mathbf{P})\mathbf{P}$, and $\mathcal{A}_4 \equiv \mathcal{J}(\mathbf{P})$. Show that $\{\mathcal{A}_i\}_{i=1}^3$ are subalgebras of \mathcal{A} and that $\mathcal{A}_i \cap \mathcal{A}_j = \{\mathbf{0}\}$, but $\mathcal{A}_i\mathcal{A}_j \neq \{\mathbf{0}\}$ for all $i \neq j$, $i, j = 1, \dots, 4$. Thus, Peirce decomposition is a vector space direct sum, but not an algebra direct sum.

3.34 Let \mathbf{p} and \mathbf{q} be orthogonal idempotents. Suppose that $\mathbf{q} = \mathbf{q}_1 + \mathbf{q}_2$, where \mathbf{q}_1 and \mathbf{q}_2 are orthogonal idempotents. Show that $\mathbf{q}\mathbf{q}_i = \mathbf{q}_i\mathbf{q} = \mathbf{q}_i$ for $i = 1, 2$. Using this result, show that $\mathbf{p}\mathbf{q}_i = \mathbf{q}_i\mathbf{p} = \mathbf{0}$ for $i = 1, 2$.

3.35 Use the basis $\{\mathbf{a}^k\}_{k=0}^{\infty}$ of $\mathcal{P}[\mathbf{a}]$ and apply Theorem 3.4.4 on it to show that the differentiation map of Definition 3.6.2 is a derivation.

3.36 Derive the chain rule (3.17).

Chapter 3 introduced algebras, i.e., vector spaces in which one can multiply two vectors to obtain a third vector. In this chapter, we want to investigate the algebra of linear transformations.

4.1 Algebra of End(V)

The product in the algebra of the endomorphisms $\text{End}(V)$ of a vector space V is defined as the composition of maps. In addition to the zero element, which is present in all algebras, $\text{End}(V)$ has an identity element, $\mathbf{1}$, which satisfies the relation $\mathbf{1}|a\rangle = |a\rangle$ for all $|a\rangle \in V$. Thus, $\text{End}(V)$ is a unital algebra. With $\mathbf{1}$ in our possession, we can ask whether it is possible to find an operator \mathbf{T}^{-1} with the property that $\mathbf{T}^{-1}\mathbf{T} = \mathbf{T}\mathbf{T}^{-1} = \mathbf{1}$. Generally speaking, only bijective mappings have inverses. Therefore, *only automorphisms of a vector space are invertible.*

Example 4.1.1 Let the linear operator $\mathbf{T} : \mathbb{R}^3 \rightarrow \mathbb{R}^3$ be defined by

$$\mathbf{T}(x_1, x_2, x_3) = (x_1 + x_2, x_2 + x_3, x_1 + x_3).$$

We want to see whether \mathbf{T} is invertible and, if so, find its inverse. \mathbf{T} has an inverse if and only if it is bijective. By the comments after Theorem 2.3.13 this is the case if and only if \mathbf{T} is either surjective or injective. The latter is equivalent to $\ker \mathbf{T} = |0\rangle$. But $\ker \mathbf{T}$ is the set of all vectors satisfying $\mathbf{T}(x_1, x_2, x_3) = (0, 0, 0)$, or

$$x_1 + x_2 = 0, \quad x_2 + x_3 = 0, \quad x_1 + x_3 = 0.$$

The reader may check that the unique solution to these equations is $x_1 = x_2 = x_3 = 0$. Thus, the only vector belonging to $\ker \mathbf{T}$ is the zero vector. Therefore, \mathbf{T} has an inverse.

To find \mathbf{T}^{-1} apply $\mathbf{T}^{-1}\mathbf{T} = \mathbf{1}$ to (x_1, x_2, x_3) :

$$(x_1, x_2, x_3) = \mathbf{T}^{-1}\mathbf{T}(x_1, x_2, x_3) = \mathbf{T}^{-1}(x_1 + x_2, x_2 + x_3, x_1 + x_3).$$

This equation demonstrates how \mathbf{T}^{-1} acts on vectors. To make this more apparent, we let $x_1 + x_2 = x$, $x_2 + x_3 = y$, $x_1 + x_3 = z$, solve for x_1 , x_2 , and x_3 in terms of x , y , and z , and substitute in the preceding equation to obtain

$$\mathbf{T}^{-1}(x, y, z) = \frac{1}{2}(x - y + z, x + y - z, -x + y + z).$$

Rewriting this equation in terms of x_1 , x_2 , and x_3 gives

$$\mathbf{T}^{-1}(x_1, x_2, x_3) = \frac{1}{2}(x_1 - x_2 + x_3, x_1 + x_2 - x_3, -x_1 + x_2 + x_3).$$

We can easily verify that $\mathbf{T}^{-1}\mathbf{T} = \mathbf{1}$ and that $\mathbf{T}\mathbf{T}^{-1} = \mathbf{1}$.

Since $\text{End}(\mathcal{V})$ is associative, Theorem 3.1.2 applies to it. Nevertheless, we restate it in the context of operators as a corollary in which we also include a generalization of Theorem 2.3.19:

Corollary 4.1.2 *The inverse of a linear operator is unique. If \mathbf{T} and \mathbf{S} are two invertible linear operators on \mathcal{V} , then \mathbf{TS} is also invertible and*

$$(\mathbf{TS})^{-1} = \mathbf{S}^{-1}\mathbf{T}^{-1}.$$

The following proposition, whose straightforward proof is left as an exercise for the reader, turns out to be useful later on:

Proposition 4.1.3 *An endomorphism $\mathbf{T} \in \text{End}(\mathcal{V})$ is invertible iff it sends a basis of \mathcal{V} onto another basis of \mathcal{V} .*

Let \mathcal{V}_1 and \mathcal{V}_2 be vector spaces and $\mathcal{L}_1(\mathcal{V}_1)$ and $\mathcal{L}_2(\mathcal{V}_2)$ the set of their endomorphisms. A natural definition of $\mathcal{L}(\mathcal{V}_1 \otimes \mathcal{V}_2)$ is given by

$$\mathcal{L}(\mathcal{V}_1 \otimes \mathcal{V}_2) \cong (\mathcal{L}_1 \otimes \mathcal{L}_2)(\mathcal{V}_1 \otimes \mathcal{V}_2) \cong \mathcal{L}_1(\mathcal{V}_1) \otimes \mathcal{L}_2(\mathcal{V}_2). \quad (4.1)$$

In particular, if $\mathcal{V}_1 = \mathbb{C}$, $\mathcal{V}_2 = \mathcal{V}$ is a *real* vector space, then

$$\mathcal{L}(\mathbb{C} \otimes \mathcal{V}) \cong \mathcal{L}(\mathcal{V}^{\mathbb{C}}), \quad (4.2)$$

where $\mathcal{V}^{\mathbb{C}}$ is the complexification of \mathcal{V} as given in Definition 2.4.8. It is important to note that

$$\mathcal{L}(\mathbb{C} \otimes \mathcal{V}) \not\cong \mathbb{C} \otimes \mathcal{L}(\mathcal{V})$$

because $\mathcal{L}(\mathbb{C}) \not\cong \mathbb{C}$.

4.1.1 Polynomials of Operators

From Sect. 3.6, we know that we can construct polynomials of $\mathbf{T} \in \text{End}(\mathcal{V})$ such as

$$p(\mathbf{T}) = \alpha_0 \mathbf{1} + \alpha_1 \mathbf{T} + \alpha_2 \mathbf{T}^2 + \cdots + \alpha_n \mathbf{T}^n.$$

We shall use these polynomials as starting points for constructing functions of operators.

Example 4.1.4 Let $\mathbf{T}_\theta : \mathbb{R}^2 \rightarrow \mathbb{R}^2$ be the linear operator that rotates vectors in the xy -plane through the angle θ , that is,

$$\mathbf{T}_\theta(x, y) = (x \cos \theta - y \sin \theta, x \sin \theta + y \cos \theta).$$

We are interested in powers of \mathbf{T}_θ :

$$\begin{aligned} \mathbf{T}_\theta^2(x, y) &= \mathbf{T}_\theta(\overbrace{x \cos \theta - y \sin \theta}^{x'}, \overbrace{x \sin \theta + y \cos \theta}^{y'}) \\ &= (x' \cos \theta - y' \sin \theta, x' \sin \theta + y' \cos \theta) \\ &= ((x \cos \theta - y \sin \theta) \cos \theta - (x \sin \theta + y \cos \theta) \sin \theta, \\ &\quad (x \cos \theta - y \sin \theta) \sin \theta + (x \sin \theta + y \cos \theta) \cos \theta) \\ &= (x \cos 2\theta - y \sin 2\theta, x \sin 2\theta + y \cos 2\theta). \end{aligned}$$

Thus, \mathbf{T}^2 rotates (x, y) by 2θ . Similarly, one can show that

$$\mathbf{T}_\theta^3(x, y) = (x \cos 3\theta - y \sin 3\theta, x \sin 3\theta + y \cos 3\theta),$$

and in general, $\mathbf{T}_\theta^n(x, y) = (x \cos n\theta - y \sin n\theta, x \sin n\theta + y \cos n\theta)$, which shows that \mathbf{T}_θ^n is a rotation of (x, y) through the angle $n\theta$, that is, $\mathbf{T}_\theta^n = \mathbf{T}_{n\theta}$. This result could have been guessed because \mathbf{T}_θ^n is equivalent to rotating (x, y) n times, each time by an angle θ .

Negative powers of an invertible linear operator \mathbf{T} are defined by $\mathbf{T}^{-m} = (\mathbf{T}^{-1})^m$. The exponents of \mathbf{T} satisfy the usual rules.¹ In particular, for any two integers m and n (positive or negative), $\mathbf{T}^m \mathbf{T}^n = \mathbf{T}^{m+n}$ and $(\mathbf{T}^m)^n = \mathbf{T}^{mn}$. The first relation implies that the inverse of \mathbf{T}^m is \mathbf{T}^{-m} . One can further generalize the exponent to include fractions and ultimately all real numbers; but we need to wait until Chap. 6, in which we discuss the spectral decomposition theorem.

Example 4.1.5 Let us evaluate \mathbf{T}_θ^{-n} for the operator of the previous example. First, let us find \mathbf{T}_θ^{-1} (see Fig. 4.1). We are looking for an operator such that $\mathbf{T}_\theta^{-1} \mathbf{T}_\theta(x, y) = (x, y)$, or

$$\mathbf{T}_\theta^{-1}(x \cos \theta - y \sin \theta, x \sin \theta + y \cos \theta) = (x, y). \quad (4.3)$$

We define $x' = x \cos \theta - y \sin \theta$ and $y' = x \sin \theta + y \cos \theta$ and solve x and y in terms of x' and y' to obtain $x = x' \cos \theta + y' \sin \theta$ and $y = -x' \sin \theta + y' \cos \theta$. Substituting for x and y in Eq. (4.3) yields

$$\mathbf{T}_\theta^{-1}(x', y') = (x' \cos \theta + y' \sin \theta, -x' \sin \theta + y' \cos \theta).$$

¹These rules apply to any associative algebra, not just to $\text{End}(V)$.

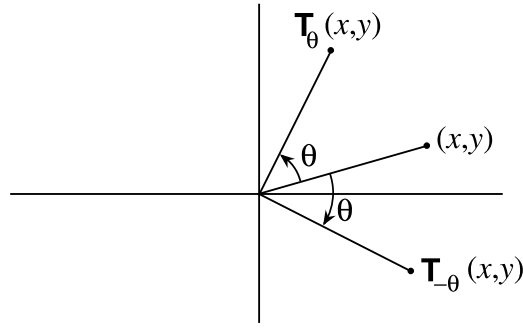

Fig. 4.1 The operator \mathbf{T}_θ and its inverse as they act on a point in the plane

Comparing this with the action of \mathbf{T}_θ in the previous example, we discover that the only difference between the two operators is the sign of the $\sin\theta$ term. We conclude that \mathbf{T}_θ^{-1} has the same effect as $\mathbf{T}_{-\theta}$. So we have

$$\mathbf{T}_\theta^{-1} = \mathbf{T}_{-\theta} \quad \text{and} \quad \mathbf{T}_\theta^{-n} = (\mathbf{T}_\theta^{-1})^n = (\mathbf{T}_{-\theta})^n = \mathbf{T}_{-n\theta}.$$

It is instructive to verify that $\mathbf{T}_\theta^{-n}\mathbf{T}_\theta^n = \mathbf{1}$:

$$\begin{aligned} \mathbf{T}_\theta^{-n}\mathbf{T}_\theta^n(x, y) &= \mathbf{T}_\theta^{-n} \left(\overbrace{x \cos n\theta - y \sin n\theta}^{x'} , \overbrace{x \sin n\theta + y \cos n\theta}^{y'} \right) \\ &= (x' \cos n\theta + y' \sin n\theta, -x' \sin n\theta + y' \cos n\theta) \\ &= ((x \cos n\theta - y \sin n\theta) \cos n\theta + (x \sin n\theta + y \cos n\theta) \sin n\theta, \\ &\quad -(x \cos n\theta - y \sin n\theta) \sin n\theta + (x \sin n\theta + y \cos n\theta) \cos n\theta) \\ &= (x(\cos^2 n\theta + \sin^2 n\theta), y(\sin^2 n\theta + \cos^2 n\theta)) = (x, y). \end{aligned}$$

Similarly, we can show that $\mathbf{T}_\theta^n\mathbf{T}_\theta^{-n}(x, y) = (x, y)$.

One has to keep in mind that $p(\mathbf{T})$ is not, in general, invertible, even if \mathbf{T} is. In fact, the sum of two invertible operators is not necessarily invertible. For example, although \mathbf{T} and $-\mathbf{T}$ are invertible, their sum, the zero operator, is not.

4.1.2 Functions of Operators

We can go one step beyond polynomials of operators and, via Taylor expansion, define functions of them. Consider an ordinary function $f(x)$, which has the Taylor expansion

$$f(x) = \sum_{k=0}^{\infty} \frac{(x - x_0)^k}{k!} \left. \frac{d^k f}{dx^k} \right|_{x=x_0}$$

in which x_0 is a point where $f(x)$ and all its derivatives are defined. To this function, there corresponds a function of the operator \mathbf{T} , defined as

$$f(\mathbf{T}) = \sum_{k=0}^{\infty} \frac{d^k f}{dx^k} \Big|_{x=x_0} \frac{(\mathbf{T} - x_0 \mathbf{1})^k}{k!}. \quad (4.4)$$

Because this series is an infinite sum of operators, difficulties may arise concerning its convergence. However, as will be shown in Chap. 6, $f(\mathbf{T})$ is always defined for finite-dimensional vector spaces. In fact, it is always a polynomial in \mathbf{T} (see also Problem 4.1). For the time being, we shall think of $f(\mathbf{T})$ as a formal infinite series. A simplification results when the function can be expanded about $x = 0$. In this case we obtain

$$f(\mathbf{T}) = \sum_{k=0}^{\infty} \frac{d^k f}{dx^k} \Big|_{x=0} \frac{\mathbf{T}^k}{k!}. \quad (4.5)$$

A widely used function is the exponential, whose expansion is easily found to be

$$e^{\mathbf{T}} \equiv \exp(\mathbf{T}) = \sum_{k=0}^{\infty} \frac{\mathbf{T}^k}{k!}. \quad (4.6)$$

Example 4.1.6 Let us evaluate $\exp(\alpha \mathbf{T})$ when $\mathbf{T}: \mathbb{R}^2 \rightarrow \mathbb{R}^2$ is given by

$$\mathbf{T}(x, y) = (-y, x).$$

We can find a general formula for the action of \mathbf{T}^n on (x, y) . Start with $n = 2$:

$$\mathbf{T}^2(x, y) = \mathbf{T}(-y, x) = (-x, -y) = -(x, y) = -\mathbf{1}(x, y).$$

Thus, $\mathbf{T}^2 = -\mathbf{1}$. From \mathbf{T} and \mathbf{T}^2 we can easily obtain higher powers of \mathbf{T} . For example: $\mathbf{T}^3 = \mathbf{T}(\mathbf{T}^2) = -\mathbf{T}$, $\mathbf{T}^4 = \mathbf{T}^2 \mathbf{T}^2 = \mathbf{1}$, and in general,

$$\begin{aligned} \mathbf{T}^{2n} &= (-1)^n \mathbf{1} \quad \text{for } n = 0, 1, 2, \dots \\ \mathbf{T}^{2n+1} &= (-1)^n \mathbf{T} \quad \text{for } n = 0, 1, 2, \dots \end{aligned}$$

Thus,

$$\begin{aligned} \exp(\alpha \mathbf{T}) &= \sum_{n \text{ odd}} \frac{(\alpha \mathbf{T})^n}{n!} + \sum_{n \text{ even}} \frac{(\alpha \mathbf{T})^n}{n!} = \sum_{k=0}^{\infty} \frac{(\alpha \mathbf{T})^{2k+1}}{(2k+1)!} + \sum_{k=0}^{\infty} \frac{(\alpha \mathbf{T})^{2k}}{(2k)!} \\ &= \sum_{k=0}^{\infty} \frac{\alpha^{2k+1} \mathbf{T}^{2k+1}}{(2k+1)!} + \sum_{k=0}^{\infty} \frac{\alpha^{2k} \mathbf{T}^{2k}}{(2k)!} \\ &= \sum_{k=0}^{\infty} \frac{(-1)^k \alpha^{2k+1}}{(2k+1)!} \mathbf{T} + \sum_{k=0}^{\infty} \frac{(-1)^k \alpha^{2k}}{(2k)!} \mathbf{1} \end{aligned}$$

$$= \mathbf{T} \sum_{k=0}^{\infty} \frac{(-1)^k \alpha^{2k+1}}{(2k+1)!} + \mathbf{1} \sum_{k=0}^{\infty} \frac{(-1)^k \alpha^{2k}}{(2k)!}.$$

The two series are recognized as $\sin \alpha$ and $\cos \alpha$, respectively. Therefore, we get

$$e^{\alpha \mathbf{T}} = \mathbf{T} \sin \alpha + \mathbf{1} \cos \alpha,$$

which shows that $e^{\alpha \mathbf{T}}$ is a polynomial (of first degree) in \mathbf{T} .

The action of $e^{\alpha \mathbf{T}}$ on (x, y) is given by

$$\begin{aligned} e^{\alpha \mathbf{T}}(x, y) &= (\sin \alpha \mathbf{T} + \cos \alpha \mathbf{1})(x, y) = \sin \alpha \mathbf{T}(x, y) + \cos \alpha \mathbf{1}(x, y) \\ &= (\sin \alpha)(-y, x) + (\cos \alpha)(x, y) \\ &= (-y \sin \alpha, x \sin \alpha) + (x \cos \alpha, y \cos \alpha) \\ &= (x \cos \alpha - y \sin \alpha, x \sin \alpha + y \cos \alpha). \end{aligned}$$

generator of the rotation The reader will recognize the final expression as a rotation in the xy -plane through an angle α . Thus, we can think of $e^{\alpha \mathbf{T}}$ as a rotation operator of angle α about the z -axis. In this context \mathbf{T} is called the *generator* of the rotation.

4.1.3 Commutators

The result of multiplication of two operators depends on the order in which the operators appear. This means that if $\mathbf{T}, \mathbf{U} \in \mathcal{L}(\mathcal{V})$, then $\mathbf{TU} \in \mathcal{L}(\mathcal{V})$ and $\mathbf{UT} \in \mathcal{L}(\mathcal{V})$; however, in general $\mathbf{UT} \neq \mathbf{TU}$. When this is the case, we say that \mathbf{U} and \mathbf{T} *do not commute*. The extent to which two operators fail to commute is given in the following definition.

commutator defined **Definition 4.1.7** The **commutator** $[\mathbf{U}, \mathbf{T}]$ of the two operators \mathbf{U} and \mathbf{T} in $\mathcal{L}(\mathcal{V})$ is another operator in $\mathcal{L}(\mathcal{V})$, defined as

$$[\mathbf{U}, \mathbf{T}] \equiv \mathbf{UT} - \mathbf{TU}.$$

An immediate consequence of this definition is the following:

Proposition 4.1.8 For $\mathbf{S}, \mathbf{T}, \mathbf{U} \in \mathcal{L}(\mathcal{V})$ and $\alpha, \beta \in \mathbb{C}$ (or \mathbb{R}), we have

$$\begin{aligned} [\mathbf{U}, \mathbf{T}] &= -[\mathbf{T}, \mathbf{U}], & \text{antisymmetry} \\ [\alpha \mathbf{U}, \beta \mathbf{T}] &= \alpha \beta [\mathbf{U}, \mathbf{T}], & \text{linearity} \\ [\mathbf{S}, \mathbf{T} + \mathbf{U}] &= [\mathbf{S}, \mathbf{T}] + [\mathbf{S}, \mathbf{U}], & \text{linearity in the right entry} \\ [\mathbf{S} + \mathbf{T}, \mathbf{U}] &= [\mathbf{S}, \mathbf{U}] + [\mathbf{T}, \mathbf{U}], & \text{linearity in the left entry} \\ [\mathbf{ST}, \mathbf{U}] &= \mathbf{S}[\mathbf{T}, \mathbf{U}] + [\mathbf{S}, \mathbf{U}]\mathbf{T}, & \text{right derivation property} \\ [\mathbf{S}, \mathbf{TU}] &= [\mathbf{S}, \mathbf{T}]\mathbf{U} + \mathbf{T}[\mathbf{S}, \mathbf{U}], & \text{left derivation property} \\ [[\mathbf{S}, \mathbf{T}], \mathbf{U}] &+ [[\mathbf{U}, \mathbf{S}], \mathbf{T}] + [[\mathbf{T}, \mathbf{U}], \mathbf{S}] = 0, & \text{Jacobi identity} \end{aligned}$$

Proof In almost all cases the proof follows immediately from the definition. The only minor exceptions are the derivation properties. We prove the left derivation property:

$$\begin{aligned} [\mathbf{S}, \mathbf{TU}] &= \mathbf{S}(\mathbf{TU}) - (\mathbf{TU})\mathbf{S} = \mathbf{STU} - \mathbf{TUS} + \underbrace{\mathbf{TSU} - \mathbf{TSU}}_{=0} \\ &= (\mathbf{ST} - \mathbf{TS})\mathbf{U} + \mathbf{T}(\mathbf{SU} - \mathbf{US}) = [\mathbf{S}, \mathbf{T}]\mathbf{U} + \mathbf{T}[\mathbf{S}, \mathbf{U}]. \end{aligned}$$

The right derivation property is proved in exactly the same way. \square

A useful consequence of the definition and Proposition 4.1.8 is

$$[\mathbf{A}, \mathbf{A}^m] = \mathbf{0} \quad \text{for } m = 0, \pm 1, \pm 2, \dots$$

In particular, $[\mathbf{A}, \mathbf{1}] = \mathbf{0}$ and $[\mathbf{A}, \mathbf{A}^{-1}] = \mathbf{0}$.

An example of the commutators of operators is that of \mathbf{D} and \mathbf{T} defined in Example 2.3.5. The reader is urged to verify that

$$[\mathbf{D}, \mathbf{T}] = \mathbf{1} \tag{4.7}$$

4.2 Derivatives of Operators

Up to this point we have been discussing the algebraic properties of operators, static objects that obey certain algebraic rules and fulfill the static needs of some applications. However, physical quantities are dynamic, and if we want operators to represent physical quantities, we must allow them to change with time. This dynamism is best illustrated in quantum mechanics, where physical observables are represented by operators.

Let us consider a mapping $\mathbf{H} : \mathbb{R} \rightarrow \text{End}(\mathcal{V})$, which² takes in a real number and gives out a linear operator on the vector space \mathcal{V} . We denote the image of $t \in \mathbb{R}$ by $\mathbf{H}(t)$, which acts on the underlying vector space \mathcal{V} . The physical meaning of this is that as t (usually time) varies, its image $\mathbf{H}(t)$ also varies. Therefore, for different values of t , we have *different* operators. In particular, $[\mathbf{H}(t), \mathbf{H}(t')] \neq \mathbf{0}$ for $t \neq t'$. A concrete example is an operator that is a linear combination of the operators \mathbf{D} and \mathbf{T} introduced in Example 2.3.5, with time-dependent scalars. To be specific, let $\mathbf{H}(t) = \mathbf{D} \cos \omega t + \mathbf{T} \sin \omega t$, where ω is a constant. As time passes, $\mathbf{H}(t)$ changes its identity from \mathbf{D} to \mathbf{T} and back to \mathbf{D} . Most of the time it has a hybrid identity! Since \mathbf{D} and \mathbf{T} do not commute [see Eq. (4.7)], values of $\mathbf{H}(t)$ for different times do not necessarily commute.

a time-dependent operator does not commute with itself at different times

Of particular interest are operators that can be written as $\exp(\mathbf{H}(t))$, where $\mathbf{H}(t)$ is a “simple” operator; i.e., the dependence of $\mathbf{H}(t)$ on t is sim-

²Strictly speaking, the domain of \mathbf{H} must be an interval $[a, b]$ of the real line, because \mathbf{H} may not be defined for all \mathbb{R} . However, for our purposes, such a fine distinction is not necessary.

pler than the corresponding dependence of $\exp(\mathbf{H}(t))$. We have already encountered such a situation in Example 4.1.6, where it was shown that the operation of rotation around the z -axis could be written as $\exp(\alpha\mathbf{T})$, and the action of \mathbf{T} on (x, y) was a great deal simpler than the corresponding action of $\exp(\alpha\mathbf{T})$.

Euler's theorem and
Euler angles

Such a state of affairs is very common in physics. In fact, it can be shown that many operators of physical interest can be written as a product of simpler operators, each being of the form $\exp(\alpha\mathbf{T})$. For example, we know from Euler's theorem in mechanics that an arbitrary rotation in three dimensions can be written as a product of three simpler rotations, each being a rotation through a so-called *Euler angle* about an axis.

derivative of an operator

Definition 4.2.1 For the mapping $\mathbf{H} : \mathbb{R} \rightarrow \text{End}(\mathcal{V})$, we define the **derivative** as

$$\frac{d\mathbf{H}}{dt} = \lim_{\Delta t \rightarrow 0} \frac{\mathbf{H}(t + \Delta t) - \mathbf{H}(t)}{\Delta t}.$$

This derivative also belongs to $\text{End}(\mathcal{V})$.

As long as we keep track of the order, practically all the rules of differentiation apply to operators. For example,

$$\frac{d}{dt}(\mathbf{U}\mathbf{T}) = \frac{d\mathbf{U}}{dt}\mathbf{T} + \mathbf{U}\frac{d\mathbf{T}}{dt}.$$

We are not allowed to change the order of multiplication on the RHS, not even when both operators being multiplied are the same on the LHS. For instance, if we let $\mathbf{U} = \mathbf{T} = \mathbf{H}$ in the preceding equation, we obtain

$$\frac{d}{dt}(\mathbf{H}^2) = \frac{d\mathbf{H}}{dt}\mathbf{H} + \mathbf{H}\frac{d\mathbf{H}}{dt}.$$

This is *not*, in general, equal to $2\mathbf{H}\frac{d\mathbf{H}}{dt}$.

Example 4.2.2 Let us find the derivative of $\exp(t\mathbf{H})$, where \mathbf{H} is independent of t . Using Definition 4.2.1, we have

$$\frac{d}{dt}\exp(t\mathbf{H}) = \lim_{\Delta t \rightarrow 0} \frac{\exp[(t + \Delta t)\mathbf{H}] - \exp(t\mathbf{H})}{\Delta t}.$$

However, for infinitesimal Δt we have

$$\begin{aligned} \exp[(t + \Delta t)\mathbf{H}] - \exp(t\mathbf{H}) &= e^{t\mathbf{H}}e^{\Delta t\mathbf{H}} - e^{t\mathbf{H}} \\ &= e^{t\mathbf{H}}(\mathbf{1} + \mathbf{H}\Delta t) - e^{t\mathbf{H}} = e^{t\mathbf{H}}\mathbf{H}\Delta t. \end{aligned}$$

Therefore,

$$\frac{d}{dt}\exp(t\mathbf{H}) = \lim_{\Delta t \rightarrow 0} \frac{e^{t\mathbf{H}}\mathbf{H}\Delta t}{\Delta t} = e^{t\mathbf{H}}\mathbf{H}.$$

Since \mathbf{H} and $e^{t\mathbf{H}}$ commute,³ we also have

$$\frac{d}{dt} \exp(t\mathbf{H}) = \mathbf{H}e^{t\mathbf{H}}.$$

Note that in deriving the equation for the derivative of $e^{t\mathbf{H}}$, we have used the relation $e^{t\mathbf{H}}e^{\Delta t\mathbf{H}} = e^{(t+\Delta t)\mathbf{H}}$. This may seem trivial, but it will be shown later that in general, $e^{\mathbf{S}+\mathbf{T}} \neq e^{\mathbf{S}}e^{\mathbf{T}}$.

Now let us evaluate the derivative of a more general time-dependent operator, $\exp[\mathbf{H}(t)]$:

$$\frac{d}{dt} \exp[\mathbf{H}(t)] = \lim_{\Delta t \rightarrow 0} \frac{\exp[\mathbf{H}(t + \Delta t)] - \exp[\mathbf{H}(t)]}{\Delta t}.$$

If $\mathbf{H}(t)$ possesses a derivative, we have, to the first order in Δt ,

$$\mathbf{H}(t + \Delta t) = \mathbf{H}(t) + \Delta t \frac{d\mathbf{H}}{dt},$$

and we can write $\exp[\mathbf{H}(t + \Delta t)] = \exp[\mathbf{H}(t) + \Delta t d\mathbf{H}/dt]$. It is very tempting to factor out the $\exp[\mathbf{H}(t)]$ and expand the remaining part. However, as we will see presently, this is not possible in general. As preparation, consider the following example, which concerns the integration of an operator.

Example 4.2.3 The Schrödinger equation

$$i \frac{\partial}{\partial t} |\psi(t)\rangle = \mathbf{H}|\psi(t)\rangle$$

can be turned into an *operator differential equation* as follows. Define the so-called **evolution operator** $\mathbf{U}(t)$ by $|\psi(t)\rangle = \mathbf{U}(t)|\psi(0)\rangle$, and substitute

evolution operator

$$i \frac{\partial}{\partial t} \mathbf{U}(t) |\psi(0)\rangle = \mathbf{H}\mathbf{U}(t) |\psi(0)\rangle.$$

Ignoring the arbitrary vector $|\psi(0)\rangle$ results in $d\mathbf{U}/dt = -i\mathbf{H}\mathbf{U}(t)$, a differential equation in $\mathbf{U}(t)$, where \mathbf{H} is not dependent on t . We can find a solution to such an equation by repeated differentiation followed by Taylor series expansion. Thus,

$$\begin{aligned} \frac{d^2\mathbf{U}}{dt^2} &= -i\mathbf{H} \frac{d\mathbf{U}}{dt} = -i\mathbf{H}[-i\mathbf{H}\mathbf{U}(t)] = (-i\mathbf{H})^2\mathbf{U}(t), \\ \frac{d^3\mathbf{U}}{dt^3} &= \frac{d}{dt}[(-i\mathbf{H})^2\mathbf{U}(t)] = (-i\mathbf{H})^2 \frac{d\mathbf{U}}{dt} = (-i\mathbf{H})^3\mathbf{U}(t). \end{aligned}$$

³This is a consequence of a more general result that if two operators commute, any pair of functions of those operators also commute (see Problem 4.14).

In general $d^n \mathbf{U}/dt^n = (-i\mathbf{H})^n \mathbf{U}(t)$. Assuming that $\mathbf{U}(t)$ is well-defined at $t = 0$, the above relations say that all derivatives of $\mathbf{U}(t)$ are also well-defined at $t = 0$. Therefore, we can expand $\mathbf{U}(t)$ around $t = 0$ to obtain

$$\begin{aligned} \mathbf{U}(t) &= \sum_{n=0}^{\infty} \frac{t^n}{n!} \left(\frac{d^n \mathbf{U}}{dt^n} \right)_{t=0} = \sum_{n=0}^{\infty} \frac{t^n}{n!} (-i\mathbf{H})^n \mathbf{U}(0) \\ &= \left(\sum_{n=0}^{\infty} \frac{(-it\mathbf{H})^n}{n!} \right) \mathbf{U}(0) = e^{-it\mathbf{H}} \mathbf{U}(0). \end{aligned}$$

But $\mathbf{U}(0) = \mathbf{1}$ by the definition of $\mathbf{U}(t)$. Hence, $\mathbf{U}(t) = e^{-it\mathbf{H}}$, and

$$|\psi(t)\rangle = e^{-it\mathbf{H}} |\psi(0)\rangle.$$

Let us see under what conditions we have $\exp(\mathbf{S} + \mathbf{T}) = \exp(\mathbf{S}) \exp(\mathbf{T})$. We consider only the case where the commutator of the two operators commutes with both of them:

$$[\mathbf{T}, [\mathbf{S}, \mathbf{T}]] = \mathbf{0} = [\mathbf{S}, [\mathbf{S}, \mathbf{T}]].$$

Now consider the operator $\mathbf{U}(t) = e^{t\mathbf{S}} e^{t\mathbf{T}} e^{-t(\mathbf{S}+\mathbf{T})}$ and differentiate it using the result of Example 4.2.2 and the product rule for differentiation:

$$\begin{aligned} \frac{d\mathbf{U}}{dt} &= \mathbf{S} e^{t\mathbf{S}} e^{t\mathbf{T}} e^{-t(\mathbf{S}+\mathbf{T})} + e^{t\mathbf{S}} \mathbf{T} e^{t\mathbf{T}} e^{-t(\mathbf{S}+\mathbf{T})} - e^{t\mathbf{S}} e^{t\mathbf{T}} (\mathbf{S} + \mathbf{T}) e^{-t(\mathbf{S}+\mathbf{T})} \\ &= \mathbf{S} e^{t\mathbf{S}} e^{t\mathbf{T}} e^{-t(\mathbf{S}+\mathbf{T})} - e^{t\mathbf{S}} e^{t\mathbf{T}} \mathbf{S} e^{-t(\mathbf{S}+\mathbf{T})}. \end{aligned} \quad (4.8)$$

The three factors of $\mathbf{U}(t)$ are present in all terms; however, they are not always next to one another. We can switch the operators if we introduce a commutator. For instance, $e^{t\mathbf{T}} \mathbf{S} = \mathbf{S} e^{t\mathbf{T}} + [e^{t\mathbf{T}}, \mathbf{S}]$.

It is left as a problem for the reader to show that if $[\mathbf{S}, \mathbf{T}]$ commutes with \mathbf{S} and \mathbf{T} , then $[e^{t\mathbf{T}}, \mathbf{S}] = -t[\mathbf{S}, \mathbf{T}]e^{t\mathbf{T}}$, and therefore, $e^{t\mathbf{T}} \mathbf{S} = \mathbf{S} e^{t\mathbf{T}} - t[\mathbf{S}, \mathbf{T}]e^{t\mathbf{T}}$. Substituting this in Eq. (4.8) and noting that $e^{t\mathbf{S}} \mathbf{S} = \mathbf{S} e^{t\mathbf{S}}$ yields $d\mathbf{U}/dt = t[\mathbf{S}, \mathbf{T}]\mathbf{U}(t)$. The solution to this equation is

$$\mathbf{U}(t) = \exp\left(\frac{t^2}{2}[\mathbf{S}, \mathbf{T}]\right) \Rightarrow e^{t\mathbf{S}} e^{t\mathbf{T}} e^{-t(\mathbf{S}+\mathbf{T})} = \exp\left(\frac{t^2}{2}[\mathbf{S}, \mathbf{T}]\right)$$

because $\mathbf{U}(0) = \mathbf{1}$. We thus have the following:

Proposition 4.2.4 *Let $\mathbf{S}, \mathbf{T} \in \mathcal{L}(\mathcal{V})$. If $[\mathbf{S}, [\mathbf{S}, \mathbf{T}]] = \mathbf{0} = [\mathbf{T}, [\mathbf{S}, \mathbf{T}]]$, then the Baker–Campbell–Hausdorff formula holds:*

Baker-Campbell-
Hausdorff
formula

$$e^{t\mathbf{S}} e^{t\mathbf{T}} e^{-(t^2/2)[\mathbf{S}, \mathbf{T}]} = e^{t(\mathbf{S}+\mathbf{T})}. \quad (4.9)$$

In particular, $e^{t\mathbf{S}} e^{t\mathbf{T}} = e^{t(\mathbf{S}+\mathbf{T})}$ if and only if $[\mathbf{S}, \mathbf{T}] = \mathbf{0}$.

If $t = 1$, Eq. (4.9) reduces to

$$e^{\mathbf{S}} e^{\mathbf{T}} e^{-(1/2)[\mathbf{S}, \mathbf{T}]} = e^{\mathbf{S}+\mathbf{T}}. \quad (4.10)$$

Now assume that both $\mathbf{H}(t)$ and its derivative commute with $[\mathbf{H}, d\mathbf{H}/dt]$. Letting $\mathbf{S} = \mathbf{H}(t)$ and $\mathbf{T} = \Delta t d\mathbf{H}/dt$ in (4.10), we obtain

$$\begin{aligned} e^{\mathbf{H}(t+\Delta t)} &= e^{\mathbf{H}(t)+\Delta t d\mathbf{H}/dt} \\ &= e^{\mathbf{H}(t)} e^{\Delta t(d\mathbf{H}/dt)} e^{-[\mathbf{H}(t), \Delta t d\mathbf{H}/dt]/2}. \end{aligned}$$

For infinitesimal Δt , this yields

$$\begin{aligned} e^{\mathbf{H}(t+\Delta t)} &= e^{\mathbf{H}(t)} \left(\mathbf{1} + \Delta t \frac{d\mathbf{H}}{dt} \right) \left(\mathbf{1} - \frac{1}{2} \Delta t \left[\mathbf{H}(t), \frac{d\mathbf{H}}{dt} \right] \right) \\ &= e^{\mathbf{H}(t)} \left\{ \mathbf{1} + \Delta t \frac{d\mathbf{H}}{dt} - \frac{1}{2} \Delta t \left[\mathbf{H}(t), \frac{d\mathbf{H}}{dt} \right] \right\}, \end{aligned}$$

and we have

$$\frac{d}{dt} e^{\mathbf{H}(t)} = e^{\mathbf{H}} \frac{d\mathbf{H}}{dt} - \frac{1}{2} e^{\mathbf{H}} \left[\mathbf{H}, \frac{d\mathbf{H}}{dt} \right].$$

We can also write

$$\begin{aligned} e^{\mathbf{H}(t+\Delta t)} &= e^{[\mathbf{H}(t)+\Delta t d\mathbf{H}/dt]} = e^{[\Delta t d\mathbf{H}/dt + \mathbf{H}(t)]} \\ &= e^{[\Delta t d\mathbf{H}/dt]} e^{\mathbf{H}(t)} e^{-[\Delta t d\mathbf{H}/dt, \mathbf{H}(t)]/2}, \end{aligned}$$

which yields

$$\frac{d}{dt} e^{\mathbf{H}(t)} = \frac{d\mathbf{H}}{dt} e^{\mathbf{H}} + \frac{1}{2} e^{\mathbf{H}} \left[\mathbf{H}, \frac{d\mathbf{H}}{dt} \right].$$

Adding the above two expressions and dividing by 2 yields the following symmetric expression for the derivative:

$$\frac{d}{dt} e^{\mathbf{H}(t)} = \frac{1}{2} \left(\frac{d\mathbf{H}}{dt} e^{\mathbf{H}} + e^{\mathbf{H}} \frac{d\mathbf{H}}{dt} \right) = \frac{1}{2} \left\{ \frac{d\mathbf{H}}{dt}, e^{\mathbf{H}} \right\},$$

where $\{\mathbf{S}, \mathbf{T}\} \equiv \mathbf{ST} + \mathbf{TS}$ is called the **anticommutator** of the operators \mathbf{S} and \mathbf{T} . We, therefore, have the following proposition. anticommutator

Proposition 4.2.5 *Let $\mathbf{H} : \mathbb{R} \rightarrow \mathcal{L}(\mathcal{V})$ and assume that \mathbf{H} and its derivative commute with $[\mathbf{H}, d\mathbf{H}/dt]$. Then*

$$\frac{d}{dt} e^{\mathbf{H}(t)} = \frac{1}{2} \left\{ \frac{d\mathbf{H}}{dt}, e^{\mathbf{H}} \right\}.$$

In particular, if $[\mathbf{H}, d\mathbf{H}/dt] = 0$, then

$$\frac{d}{dt} e^{\mathbf{H}(t)} = \frac{d\mathbf{H}}{dt} e^{\mathbf{H}} = e^{\mathbf{H}} \frac{d\mathbf{H}}{dt}.$$

A frequently encountered operator is $\mathbf{F}(t) = e^{t\mathbf{A}} \mathbf{B} e^{-t\mathbf{A}}$, where \mathbf{A} and \mathbf{B} are t -independent. It is straightforward to show that

$$\frac{d\mathbf{F}}{dt} = [\mathbf{A}, \mathbf{F}(t)] \quad \text{and} \quad \frac{d}{dt} [\mathbf{A}, \mathbf{F}(t)] = \left[\mathbf{A}, \frac{d\mathbf{F}}{dt} \right].$$

Using these results, we can write

$$\frac{d^2 \mathbf{F}}{dt^2} = \frac{d}{dt} [\mathbf{A}, \mathbf{F}(t)] = [\mathbf{A}, [\mathbf{A}, \mathbf{F}(t)]] \equiv \mathbf{A}^2 [\mathbf{F}(t)],$$

and in general, $d^n \mathbf{F}/dt^n = \mathbf{A}^n [\mathbf{F}(t)]$, where $\mathbf{A}^n [\mathbf{F}(t)]$ is defined inductively as $\mathbf{A}^n [\mathbf{F}(t)] = [\mathbf{A}, \mathbf{A}^{n-1} [\mathbf{F}(t)]]$, with $\mathbf{A}^0 [\mathbf{F}(t)] \equiv \mathbf{F}(t)$. For example,

$$\mathbf{A}^3 [\mathbf{F}(t)] = [\mathbf{A}, \mathbf{A}^2 [\mathbf{F}(t)]] = [\mathbf{A}, [\mathbf{A}, \mathbf{A} [\mathbf{F}(t)]]] = [\mathbf{A}, [\mathbf{A}, [\mathbf{A}, \mathbf{F}(t)]]].$$

Evaluating $\mathbf{F}(t)$ and all its derivatives at $t = 0$ and substituting in the Taylor expansion about $t = 0$, we get

$$\mathbf{F}(t) = \sum_{n=0}^{\infty} \frac{t^n}{n!} \left. \frac{d^n \mathbf{F}}{dt^n} \right|_{t=0} = \sum_{n=0}^{\infty} \frac{t^n}{n!} \mathbf{A}^n [\mathbf{F}(0)] = \sum_{n=0}^{\infty} \frac{t^n}{n!} \mathbf{A}^n [\mathbf{B}].$$

That is,

$$e^{t\mathbf{A}} \mathbf{B} e^{-t\mathbf{A}} = \sum_{n=0}^{\infty} \frac{t^n}{n!} \mathbf{A}^n [\mathbf{B}] \equiv \mathbf{B} + t[\mathbf{A}, \mathbf{B}] + \frac{t^2}{2!} [\mathbf{A}, [\mathbf{A}, \mathbf{B}]] + \dots$$

Sometimes this is written symbolically as

$$e^{t\mathbf{A}} \mathbf{B} e^{-t\mathbf{A}} = \left(\sum_{n=0}^{\infty} \frac{t^n}{n!} \mathbf{A}^n \right) [\mathbf{B}] \equiv e^{t\mathbf{A}} [\mathbf{B}],$$

where the RHS is merely an abbreviation of the infinite sum in the middle.

For $t = 1$ we obtain a widely used formula:

$$e^{\mathbf{A}} \mathbf{B} e^{-\mathbf{A}} = e^{\mathbf{A}} [\mathbf{B}] = \left(\sum_{n=0}^{\infty} \frac{1}{n!} \mathbf{A}^n \right) [\mathbf{B}] \equiv \mathbf{B} + [\mathbf{A}, \mathbf{B}] + \frac{1}{2!} [\mathbf{A}, [\mathbf{A}, \mathbf{B}]] + \dots$$

If \mathbf{A} commutes with $[\mathbf{A}, \mathbf{B}]$, then the infinite series truncates at the second term, and we have

$$e^{t\mathbf{A}} \mathbf{B} e^{-t\mathbf{A}} = \mathbf{B} + t[\mathbf{A}, \mathbf{B}].$$

For instance, if \mathbf{A} and \mathbf{B} are replaced by \mathbf{D} and \mathbf{T} of Example 2.3.5 and Eq. (4.7), we get

$$e^{t\mathbf{D}} \mathbf{T} e^{-t\mathbf{D}} = \mathbf{T} + t[\mathbf{D}, \mathbf{T}] = \mathbf{T} + t\mathbf{1}.$$

generator of translation

The RHS shows that the operator \mathbf{T} has been *translated* by an amount t (more precisely, by t times the unit operator). We therefore call $\exp(t\mathbf{D})$ the translation operator of \mathbf{T} by t , and we call \mathbf{D} the *generator* of translation. With a little modification \mathbf{T} and \mathbf{D} become, respectively, the position and momentum operators in quantum mechanics. Thus,

momentum as generator
of translation

Box 4.2.6 *Momentum is the generator of translation in quantum mechanics.*

But more of this later!

4.3 Conjugation of Operators

We have discussed the notion of the dual of a vector in conjunction with inner products. We now incorporate linear operators into this notion. Let $|b\rangle, |c\rangle \in \mathcal{V}$ and assume that $|c\rangle = \mathbf{T}|b\rangle$. We know that there are linear functionals in the dual space \mathcal{V}^* that are associated with $(|b\rangle)^\dagger = \langle b|$ and $(|c\rangle)^\dagger = \langle c|$. Is there a linear operator belonging to $\mathcal{L}(\mathcal{V}^*)$ that somehow corresponds to \mathbf{T} ? In other words, can we find a linear operator that relates $\langle b|$ and $\langle c|$ just as \mathbf{T} relates $|b\rangle$ and $|c\rangle$? The answer comes in the following definition.

Definition 4.3.1 Let $\mathbf{T} \in \mathcal{L}(\mathcal{V})$ and $|a\rangle, |b\rangle \in \mathcal{V}$. The **adjoint**, or **hermitian conjugate**, of \mathbf{T} is denoted by \mathbf{T}^\dagger and defined by⁴ adjoint of an operator

$$\langle a|\mathbf{T}|b\rangle^* = \langle b|\mathbf{T}^\dagger|a\rangle. \quad (4.11)$$

The LHS of Eq. (4.11) can be written as $\langle a|c\rangle^*$ or $\langle c|a\rangle$, in which case we can identify

$$\langle c| = \langle b|\mathbf{T}^\dagger \Rightarrow (\mathbf{T}|b\rangle)^\dagger = \langle b|\mathbf{T}^\dagger. \quad (4.12)$$

This equation is sometimes used as the definition of the hermitian conjugate. From Eq. (4.11), the reader may easily verify that $\mathbf{1}^\dagger = \mathbf{1}$. Thus, using the unit operator for \mathbf{T} , (4.12) justifies Eq. (2.26).

Some of the properties of conjugation are listed in the following theorem, whose proof is left as an exercise.

Theorem 4.3.2 Let $\mathbf{U}, \mathbf{T} \in \text{End}(\mathcal{V})$ and $\alpha \in \mathbb{C}$. Then

1. $(\mathbf{U} + \mathbf{T})^\dagger = \mathbf{U}^\dagger + \mathbf{T}^\dagger$.
2. $(\mathbf{UT})^\dagger = \mathbf{T}^\dagger \mathbf{U}^\dagger$.
3. $(\alpha \mathbf{T})^\dagger = \alpha^* \mathbf{T}^\dagger$.
4. $((\mathbf{T}^\dagger)^\dagger) = \mathbf{T}$.

The last identity holds for finite-dimensional vector spaces; it does not apply to infinite-dimensional vector spaces in general.

In previous examples dealing with linear operators $\mathbf{T}: \mathbb{R}^n \rightarrow \mathbb{R}^n$, an element of \mathbb{R}^n was denoted by a row vector, such as (x, y) for \mathbb{R}^2 and (x, y, z) for \mathbb{R}^3 . There was no confusion, because we were operating only in \mathcal{V} . However, since elements of both \mathcal{V} and \mathcal{V}^* are required when discussing \mathbf{T} , \mathbf{T}^* , and \mathbf{T}^\dagger , it is helpful to make a distinction between them. We therefore resort to the convention introduced in Example 2.2.3 by which

Box 4.3.3 *Kets are represented as column vectors and bras as row vectors.*

⁴With the notion of adjoint already introduced in Definition 2.4.3, we should probably not use the same name for \mathbf{T}^\dagger . However, the adjoint as defined in Definition 2.4.3 is rarely used in physics. Furthermore, both the notation and the context will make it clear which adjoint one is talking about. Therefore, there is no risk of confusion.

Example 4.3.4 Let us find the hermitian conjugate of the operator $\mathbf{T} : \mathbb{C}^3 \rightarrow \mathbb{C}^3$ given by

$$\mathbf{T} \begin{pmatrix} \alpha_1 \\ \alpha_2 \\ \alpha_3 \end{pmatrix} = \begin{pmatrix} \alpha_1 - i\alpha_2 + \alpha_3 \\ i\alpha_1 - \alpha_3 \\ \alpha_1 - \alpha_2 + i\alpha_3 \end{pmatrix}.$$

Introduce

$$|a\rangle = \begin{pmatrix} \alpha_1 \\ \alpha_2 \\ \alpha_3 \end{pmatrix} \quad \text{and} \quad |b\rangle = \begin{pmatrix} \beta_1 \\ \beta_2 \\ \beta_3 \end{pmatrix}$$

with dual vectors $\langle a| = (\alpha_1^* \alpha_2^* \alpha_3^*)$ and $\langle b| = (\beta_1^* \beta_2^* \beta_3^*)$, respectively. We use Eq. (4.11) to find \mathbf{T}^\dagger :

$$\begin{aligned} \langle b|\mathbf{T}^\dagger|a\rangle &= \langle a|\mathbf{T}|b\rangle^* = \left[(\alpha_1^* \quad \alpha_2^* \quad \alpha_3^*) \mathbf{T} \begin{pmatrix} \beta_1 \\ \beta_2 \\ \beta_3 \end{pmatrix} \right]^* \\ &= \left[(\alpha_1^* \quad \alpha_2^* \quad \alpha_3^*) \begin{pmatrix} \beta_1 - i\beta_2 + \beta_3 \\ i\beta_1 - \beta_3 \\ \beta_1 - \beta_2 + i\beta_3 \end{pmatrix} \right]^* \\ &= [\alpha_1^* \beta_1 - i\alpha_1^* \beta_2 + \alpha_1^* \beta_3 + i\alpha_2^* \beta_1 - \alpha_2^* \beta_3 + \alpha_3^* \beta_1 - \alpha_3^* \beta_2 + i\alpha_3^* \beta_3]^*. \end{aligned}$$

Taking the complex conjugate of all the numbers inside the square brackets, we find

$$\langle b|\mathbf{T}^\dagger|a\rangle = \underbrace{(\beta_1^* \quad \beta_2^* \quad \beta_3^*)}_{=\langle b|} \begin{pmatrix} \alpha_1 - i\alpha_2 + \alpha_3 \\ i\alpha_1 - \alpha_3 \\ \alpha_1 - \alpha_2 - i\alpha_3 \end{pmatrix}.$$

Therefore, we obtain

$$\mathbf{T}^\dagger \begin{pmatrix} \alpha_1 \\ \alpha_2 \\ \alpha_3 \end{pmatrix} = \begin{pmatrix} \alpha_1 - i\alpha_2 + \alpha_3 \\ i\alpha_1 - \alpha_3 \\ \alpha_1 - \alpha_2 - i\alpha_3 \end{pmatrix}.$$

4.3.1 Hermitian Operators

The process of conjugation of linear operators looks much like conjugation of complex numbers. Equation (4.11) alludes to this fact, and Theorem 4.3.2 provides further evidence. It is therefore natural to look for operators that are counterparts of real numbers. One can define complex conjugation for operators and thereby construct real operators. However, these real operators will not be interesting because—as it turns out—they completely ignore the complex character of the vector space. The following alternative definition

makes use of *hermitian* conjugation, and the result will have much wider application than is allowed by a mere *complex* conjugation.

Definition 4.3.5 A linear operator $\mathbf{H} \in \mathcal{L}(\mathcal{V})$ is called **hermitian**, or **self-adjoint**, if $\mathbf{H}^\dagger = \mathbf{H}$. Similarly, $\mathbf{A} \in \mathcal{L}(\mathcal{V})$ is called **anti-hermitian** if $\mathbf{A}^\dagger = -\mathbf{A}$.

hermitian and
anti-hermitian operators

Historical Notes

Charles Hermite (1822–1901), one of the most eminent French mathematicians of the nineteenth century, was particularly distinguished for the clean elegance and high artistic quality of his work. As a student, he courted disaster by neglecting his routine assigned work to study the classic masters of mathematics; and though he nearly failed his examinations, he became a first-rate creative mathematician while still in his early twenties. In 1870 he was appointed to a professorship at the Sorbonne, where he trained a whole generation of well-known French mathematicians, including Picard, Borel, and Poincaré. The character of his mind is suggested by a remark of Poincaré: “Talk with M. Hermite. He never evokes a concrete image, yet you soon perceive that the most abstract entities are to him like living creatures.” He disliked geometry, but was strongly attracted to number theory and analysis, and his favorite subject was elliptic functions, where these two fields touch in many remarkable ways. Earlier in the century the Norwegian genius Abel had proved that the general equation of the fifth degree cannot be solved by functions involving only rational operations and root extractions. One of Hermite’s most surprising achievements (in 1858) was to show that this equation can be solved by elliptic functions. His 1873 proof of the transcendence of e was another high point of his career.⁵ If he had been willing to dig even deeper into this vein, he could probably have disposed of π as well, but apparently he had enough of a good thing. As he wrote to a friend, “I shall risk nothing on an attempt to prove the transcendence of the number π . If others undertake this enterprise, no one will be happier than I at their success, but believe me, my dear friend, it will not fail to cost them some efforts.” As it turned out, Lindemann’s proof nine years later rested on extending Hermite’s method.

Several of his purely mathematical discoveries had unexpected applications many years later to mathematical physics. For example, the Hermitian forms and matrices that he invented in connection with certain problems of number theory turned out to be crucial for Heisenberg’s 1925 formulation of quantum mechanics, and Hermite polynomials (see Chap. 8) are useful in solving Schrödinger’s wave equation.



Charles Hermite
1822–1901

The following observations strengthen the above conjecture that conjugation of complex numbers and hermitian conjugation of operators are somehow related.

Definition 4.3.6 The **expectation value** $\langle \mathbf{T} \rangle_a$ of an operator \mathbf{T} in the “state” $|a\rangle$ is a complex number defined by $\langle \mathbf{T} \rangle_a = \langle a | \mathbf{T} | a \rangle$.

expectation value

The complex conjugate of the expectation value is⁶

$$\langle \mathbf{T} \rangle^* = \langle a | \mathbf{T} | a \rangle^* = \langle a | \mathbf{T}^\dagger | a \rangle.$$

⁵Transcendental numbers are those that are not roots of polynomials with integer coefficients.

⁶When no risk of confusion exists, it is common to drop the subscript “ a ” and write $\langle \mathbf{T} \rangle$ for the expectation value of \mathbf{T} .

In words, \mathbf{T}^\dagger , the *hermitian conjugate* of \mathbf{T} , has an expectation value that is the *complex conjugate* of the latter's expectation value. In particular, if \mathbf{T} is hermitian—is equal to its hermitian conjugate—its expectation value will be real.

What is the analogue of the known fact that a complex number is the sum of a real number and a pure imaginary one? The decomposition

$$\mathbf{T} = \frac{1}{2}(\mathbf{T} + \mathbf{T}^\dagger) + \frac{1}{2}(\mathbf{T} - \mathbf{T}^\dagger) \equiv \mathbf{X} + \mathbf{A}$$

shows that *any operator can be written as a sum of a hermitian operator* $\mathbf{X} = \frac{1}{2}(\mathbf{T} + \mathbf{T}^\dagger)$ *and an anti-hermitian operator* $\mathbf{A} = \frac{1}{2}(\mathbf{T} - \mathbf{T}^\dagger)$.

We can go even further, because any anti-hermitian operator \mathbf{A} can be written as $\mathbf{A} = i(-i\mathbf{A})$ in which $-i\mathbf{A}$ is hermitian: $(-i\mathbf{A})^\dagger = (-i)^*\mathbf{A}^\dagger = i(-\mathbf{A}) = -i\mathbf{A}$. Denoting $-i\mathbf{A}$ by \mathbf{Y} , we write $\mathbf{T} = \mathbf{X} + i\mathbf{Y}$, where both \mathbf{X} and \mathbf{Y} are *hermitian*. This is the analogue of the decomposition $z = x + iy$ in which both x and y are *real*.

Clearly, we should expect some departures from a perfect correspondence. This is due to a lack of commutativity among operators. For instance, although the product of two real numbers is real, the product of two hermitian operators is not, in general, hermitian:

$$(\mathbf{T}\mathbf{U})^\dagger = \mathbf{U}^\dagger\mathbf{T}^\dagger = \mathbf{U}\mathbf{T} \neq \mathbf{T}\mathbf{U}.$$

We have seen the relation between expectation values and conjugation properties of operators. The following theorem completely characterizes hermitian operators in terms of their expectation values:

Theorem 4.3.7 *A linear map \mathbf{H} on a complex inner product space is hermitian if and only if $\langle a|\mathbf{H}|a\rangle$ is real for all $|a\rangle$.*

Proof We have already pointed out that a hermitian operator has real expectation values. Conversely, assume that $\langle a|\mathbf{H}|a\rangle$ is real for all $|a\rangle$. Then

$$\langle a|\mathbf{H}|a\rangle = \langle a|\mathbf{H}|a\rangle^* = \langle a|\mathbf{H}^\dagger|a\rangle \Leftrightarrow \langle a|\mathbf{H} - \mathbf{H}^\dagger|a\rangle = 0 \quad \forall |a\rangle.$$

By Theorem 2.3.8 we must have $\mathbf{H} - \mathbf{H}^\dagger = \mathbf{0}$. □

Example 4.3.8 In this example, we illustrate the result of the above theorem with 2×2 matrices. The matrix $\mathbf{H} = \begin{pmatrix} 0 & -i \\ i & 0 \end{pmatrix}$ is hermitian⁷ and acts on \mathbb{C}^2 . Let us take an arbitrary vector $|a\rangle = \begin{pmatrix} \alpha_1 \\ \alpha_2 \end{pmatrix}$ and evaluate $\langle a|\mathbf{H}|a\rangle$. We have

$$\mathbf{H}|a\rangle = \begin{pmatrix} 0 & -i \\ i & 0 \end{pmatrix} \begin{pmatrix} \alpha_1 \\ \alpha_2 \end{pmatrix} = \begin{pmatrix} -i\alpha_2 \\ i\alpha_1 \end{pmatrix}.$$

⁷We assume that the reader has a casual familiarity with hermitian *matrices*. Think of an $n \times n$ matrix as a linear operator that acts on column vectors whose elements are components of vectors defined in the standard basis of \mathbb{C}^n or \mathbb{R}^n . A hermitian matrix then becomes a hermitian operator.

Therefore,

$$\begin{aligned}\langle a|\mathbf{H}|a\rangle &= (\alpha_1^* \quad \alpha_2^*) \begin{pmatrix} -i\alpha_2 \\ i\alpha_1 \end{pmatrix} = -i\alpha_1^*\alpha_2 + i\alpha_2^*\alpha_1 \\ &= i\alpha_2^*\alpha_1 + (i\alpha_2^*\alpha_1)^* = 2\operatorname{Re}(i\alpha_2^*\alpha_1),\end{aligned}$$

and $\langle a|\mathbf{H}|a\rangle$ is real.

For the most general 2×2 hermitian matrix $\mathbf{H} = \begin{pmatrix} \alpha & \beta \\ \beta^* & \gamma \end{pmatrix}$, where α and γ are real, we have

$$\mathbf{H}|a\rangle = \begin{pmatrix} \alpha & \beta \\ \beta^* & \gamma \end{pmatrix} \begin{pmatrix} \alpha_1 \\ \alpha_2 \end{pmatrix} = \begin{pmatrix} \alpha\alpha_1 + \beta\alpha_2 \\ \beta^*\alpha_1 + \gamma\alpha_2 \end{pmatrix}$$

and

$$\begin{aligned}\langle a|\mathbf{H}|a\rangle &= (\alpha_1^* \quad \alpha_2^*) \begin{pmatrix} \alpha\alpha_1 + \beta\alpha_2 \\ \beta^*\alpha_1 + \gamma\alpha_2 \end{pmatrix} = \alpha_1^*(\alpha\alpha_1 + \beta\alpha_2) + \alpha_2^*(\beta^*\alpha_1 + \gamma\alpha_2) \\ &= \alpha|\alpha_1|^2 + \alpha_1^*\beta\alpha_2 + \alpha_2^*\beta^*\alpha_1 + \gamma|\alpha_2|^2 \\ &= \alpha|\alpha_1|^2 + \gamma|\alpha_2|^2 + 2\operatorname{Re}(\alpha_1^*\beta\alpha_2).\end{aligned}$$

Again $\langle a|\mathbf{H}|a\rangle$ is real.

Definition 4.3.9 An operator \mathbf{A} on an inner product space is called **positive** (written $\mathbf{A} \geq 0$) if $\langle a|\mathbf{A}|a\rangle \geq 0$ for all $|a\rangle \neq |0\rangle$. By Theorem 4.3.7 \mathbf{A} is necessarily hermitian. We say \mathbf{A} is **strictly positive** or **positive definite** (written $\mathbf{A} > 0$) if $\langle a|\mathbf{A}|a\rangle > 0$ for all $|a\rangle \neq |0\rangle$.

positive, strictly positive, and positive definite operators

Theorem 4.3.10 A strictly positive operator \mathbf{T} is invertible.

Proof By Proposition 2.3.14, it is sufficient to prove that $\ker \mathbf{T} = \{|0\rangle\}$. If $|0\rangle \neq |a\rangle \in \ker \mathbf{T}$, then $\langle a|\mathbf{T}|a\rangle = 0$, contradicting the fact that \mathbf{T} is strictly positive. \square

Example 4.3.11 An example of a positive operator is the square of a hermitian operator.⁸ We note that for any hermitian operator \mathbf{H} and any vector $|a\rangle$, we have $\langle a|\mathbf{H}^2|a\rangle = \langle a|\mathbf{H}^\dagger\mathbf{H}|a\rangle = \langle \mathbf{H}a | \mathbf{H}a \rangle \geq 0$ because of the positive definiteness of the inner product.

From the discussion of the example above, we conclude that the square of an *invertible* hermitian operator is positive definite.

⁸This is further evidence that hermitian operators are analogues of real numbers: The square of any real number is positive.

4.3.2 Unitary Operators

The reader may be familiar with two- and three-dimensional rigid rotations and the fact that they preserve distances and the scalar product.⁹ Can this be generalized to complex inner product spaces? Let $|a\rangle, |b\rangle \in \mathcal{V}$, and let \mathbf{U} be an operator on \mathcal{V} that preserves the scalar product; that is, given $|b'\rangle = \mathbf{U}|b\rangle$ and $|a'\rangle = \mathbf{U}|a\rangle$, then $\langle a' | b'\rangle = \langle a | b\rangle$. This yields

$$\langle a' | b'\rangle = (\langle a | \mathbf{U}^\dagger)(\mathbf{U}|b\rangle) = \langle a | \mathbf{U}^\dagger \mathbf{U} |b\rangle = \langle a | b\rangle = \langle a | \mathbf{1} |b\rangle.$$

Since this is true for arbitrary $|a\rangle$ and $|b\rangle$, we obtain $\mathbf{U}^\dagger \mathbf{U} = \mathbf{1}$. In the next chapter, when we introduce the concept of the determinant of operators, we shall see that this relation implies that \mathbf{U} and \mathbf{U}^\dagger are both invertible,¹⁰ with each one being the inverse of the other.

Definition 4.3.12 Let \mathcal{V} be a finite-dimensional inner product space. An operator \mathbf{U} is called a **unitary operator** if $\mathbf{U}^\dagger = \mathbf{U}^{-1}$. Unitary operators preserve the inner product of \mathcal{V} .

Example 4.3.13 The linear transformation $\mathbf{T} : \mathbb{C}^3 \rightarrow \mathbb{C}^3$ given by

$$\mathbf{T} \begin{pmatrix} \alpha_1 \\ \alpha_2 \\ \alpha_3 \end{pmatrix} = \begin{pmatrix} (\alpha_1 - i\alpha_2)/\sqrt{2} \\ (\alpha_1 + i\alpha_2 - 2\alpha_3)/\sqrt{6} \\ \{\alpha_1 - \alpha_2 + \alpha_3 + i(\alpha_1 + \alpha_2 + \alpha_3)\}/\sqrt{6} \end{pmatrix}$$

is unitary. In fact, let

$$|a\rangle = \begin{pmatrix} \alpha_1 \\ \alpha_2 \\ \alpha_3 \end{pmatrix} \quad \text{and} \quad |b\rangle = \begin{pmatrix} \beta_1 \\ \beta_2 \\ \beta_3 \end{pmatrix}$$

with dual vectors $\langle a| = (\alpha_1^* \alpha_2^* \alpha_3^*)$ and $\langle b| = (\beta_1^* \beta_2^* \beta_3^*)$, respectively. We use Eq. (4.11) and the procedure of Example 4.3.4 to find \mathbf{T}^\dagger . The result is

$$\mathbf{T}^\dagger \begin{pmatrix} \alpha_1 \\ \alpha_2 \\ \alpha_3 \end{pmatrix} = \begin{pmatrix} \frac{\alpha_1}{\sqrt{2}} + \frac{\alpha_2}{\sqrt{6}} + \frac{\alpha_3(1-i)}{\sqrt{6}} \\ \frac{i\alpha_1}{\sqrt{2}} - \frac{i\alpha_2}{\sqrt{6}} - \frac{\alpha_3(1+i)}{\sqrt{6}} \\ -\frac{2\alpha_2}{\sqrt{6}} + \frac{\alpha_3(1-i)}{\sqrt{6}} \end{pmatrix},$$

and we can verify that

$$\mathbf{T}\mathbf{T}^\dagger \begin{pmatrix} \alpha_1 \\ \alpha_2 \\ \alpha_3 \end{pmatrix} = \begin{pmatrix} \alpha_1 \\ \alpha_2 \\ \alpha_3 \end{pmatrix}.$$

⁹We have also encountered isometries, which are more general than unitary operators. The word “unitary” is usually reserved for isometries on sesquilinear (hermitian) inner product spaces.

¹⁰This implication holds only for finite-dimensional vector spaces.

Thus $\mathbf{T}\mathbf{T}^\dagger = \mathbf{1}$. Similarly, we can show that $\mathbf{T}^\dagger\mathbf{T} = \mathbf{1}$ and therefore that \mathbf{T} is unitary.

4.4 Idempotents

We have already considered the decomposition of a vector space into subspaces in Sect. 2.1.3. We have also pointed out the significance of subspaces resulting from the fact that physics frequently takes place not inside the whole vector space, but in one of its subspaces. For instance, the study of projectile motion teaches us that it is very convenient to “project” the motion onto the horizontal and vertical axes and to study these projections separately. It is, therefore, appropriate to ask how we can go from a full space to one of its subspaces in the context of linear operators.

Let us first consider a simple example. A point in the plane is designated by the coordinates (x, y) . A subspace of the plane is the x -axis. Is there a *linear* operator,¹¹ say \mathbf{P}_x , that acts on such a point and somehow sends it into that subspace? Of course, there are many operators from \mathbb{R}^2 to \mathbb{R} . However, we are looking for a specific one. We want \mathbf{P}_x to *project* the point onto the x -axis. Such an operator has to act on (x, y) and produce $(x, 0)$: $\mathbf{P}_x(x, y) = (x, 0)$. Therefore, if the point already lies on the x -axis, \mathbf{P}_x does not change it. In particular, if we apply \mathbf{P}_x twice, we get the same result as if we apply it only once. And this is true for any point in the plane. Therefore, our operator must have the property $\mathbf{P}_x^2 = \mathbf{P}_x$, i.e., it must be an idempotent of the algebra $\text{End}(\mathcal{V})$.

Suppose that \mathcal{V} is the direct sum of r of its subspaces:

$$\mathcal{V} = \mathcal{U}_1 \oplus \cdots \oplus \mathcal{U}_r = \bigoplus_{i=1}^r \mathcal{U}_i.$$

For any $|v\rangle \in \mathcal{V}$, define \mathbf{P}_j by $\mathbf{P}_j|v\rangle = |v_j\rangle$, where $|v_j\rangle$ is the component of $|v\rangle$ in \mathcal{U}_j . It is easy (and instructive) to prove that \mathbf{P}_j is a linear operator; i.e., that $\mathbf{P}_j \in \text{End}(\mathcal{V})$. Moreover, since $\mathbf{P}_j|v_j\rangle = |v_j\rangle$ for all $|v_j\rangle \in \mathcal{U}_j$, we have

$$\mathbf{P}_j^2|v\rangle = \mathbf{P}_j\mathbf{P}_j|v\rangle = \mathbf{P}_j|v_j\rangle = |v_j\rangle = \mathbf{P}_j|v\rangle$$

for all $|v\rangle \in \mathcal{V}$. It follows that $\mathbf{P}_j^2 = \mathbf{P}_j$, i.e., that \mathbf{P}_j is an idempotent.

Next note that, for $j \neq k$,

$$\mathbf{P}_j\mathbf{P}_k|v\rangle = \mathbf{P}_j|v_k\rangle = |0\rangle,$$

because $|v_k\rangle$ has no component in \mathcal{U}_j . Since this is true for all $j \neq k$ and all $|v\rangle \in \mathcal{V}$, we have

$$\mathbf{P}_j\mathbf{P}_k = \mathbf{P}_k\mathbf{P}_j = \mathbf{0},$$

¹¹We want this operator to preserve the vector-space structure of the plane and the axis.

i.e., that the idempotents are orthogonal. Furthermore, since

$$\mathbf{1}|v\rangle = |v\rangle = \sum_{j=1}^r |v_j\rangle = \sum_{j=1}^r \mathbf{P}_j |v\rangle = \left(\sum_{j=1}^r \mathbf{P}_j \right) |v\rangle$$

for all $|v\rangle \in \mathcal{V}$, we must have $\sum_{j=1}^r \mathbf{P}_j = \mathbf{1}$. We summarize the foregoing observation as

Proposition 4.4.1 *Let \mathcal{V} be the direct sum of $\{\mathcal{U}_i\}_{i=1}^r$ and let $\mathbf{P}_j \in \mathcal{L}(\mathcal{V})$ be defined by $\mathbf{P}_j |v\rangle = |v_j\rangle$ with $|v_j\rangle$ the component of $|v\rangle$ in \mathcal{U}_j . Then $\{\mathbf{P}_i\}_{i=1}^r$ is a complete set of orthogonal idempotents, i.e.,*

$$\mathbf{P}_i \mathbf{P}_j = \delta_{ij} \mathbf{P}_i \text{ (no sum)} \quad \text{and} \quad \sum_{j=1}^r \mathbf{P}_j = \mathbf{1}.$$

If $\mathbf{T} \in \text{End}(\mathcal{V})$ and $\{\mathbf{P}_i\}_{i=1}^r$ is a complete set of orthogonal idempotents corresponding to $\{\mathcal{U}_i\}_{i=1}^r$, then \mathbf{T} can be written as a sum of operators which restrict to the subspaces. More precisely, multiply the sum in Proposition 4.4.1 by \mathbf{T} on the right to get

$$\mathbf{T} = \sum_{j=1}^r \mathbf{P}_j \mathbf{T} \equiv \sum_{j=1}^r \mathbf{T}_j, \quad \mathbf{T}_j = \mathbf{P}_j \mathbf{T} \quad (4.13)$$

and note that $\mathbf{T}_j \in \text{End}(\mathcal{U}_j)$.

4.4.1 Projection Operators

When the vector space carries an inner product, it is useful to demand hermiticity for the idempotents:

projection operators **Definition 4.4.2** A hermitian idempotent of $\text{End}(\mathcal{V})$ is called a **projection operator**.

Consider two projection operators \mathbf{P}_1 and \mathbf{P}_2 . We want to investigate conditions under which $\mathbf{P}_1 + \mathbf{P}_2$ becomes a projection operator. By definition,

$$\mathbf{P}_1 + \mathbf{P}_2 = (\mathbf{P}_1 + \mathbf{P}_2)^2 = \mathbf{P}_1^2 + \mathbf{P}_1 \mathbf{P}_2 + \mathbf{P}_2 \mathbf{P}_1 + \mathbf{P}_2^2 = \mathbf{P}_1 + \mathbf{P}_1 \mathbf{P}_2 + \mathbf{P}_2 \mathbf{P}_1 + \mathbf{P}_2.$$

So $\mathbf{P}_1 + \mathbf{P}_2$ is a projection operator if and only if

$$\mathbf{P}_1 \mathbf{P}_2 + \mathbf{P}_2 \mathbf{P}_1 = 0. \quad (4.14)$$

Multiply this on the left by \mathbf{P}_1 to get

$$\mathbf{P}_1^2 \mathbf{P}_2 + \mathbf{P}_1 \mathbf{P}_2 \mathbf{P}_1 = 0 \quad \Rightarrow \quad \mathbf{P}_1 \mathbf{P}_2 + \mathbf{P}_1 \mathbf{P}_2 \mathbf{P}_1 = 0.$$

Now multiply the same equation on the right by \mathbf{P}_1 to get

$$\mathbf{P}_1 \mathbf{P}_2 \mathbf{P}_1 + \mathbf{P}_2 \mathbf{P}_1^2 = 0 \quad \Rightarrow \quad \mathbf{P}_1 \mathbf{P}_2 \mathbf{P}_1 + \mathbf{P}_2 \mathbf{P}_1 = 0.$$

These last two equations yield

$$\mathbf{P}_1\mathbf{P}_2 - \mathbf{P}_2\mathbf{P}_1 = 0. \quad (4.15)$$

The solution to Eqs. (4.14) and (4.15) is $\mathbf{P}_1\mathbf{P}_2 = \mathbf{P}_2\mathbf{P}_1 = 0$. We therefore have the following result.

Proposition 4.4.3 *Let $\mathbf{P}_1, \mathbf{P}_2 \in \mathcal{L}(\mathcal{V})$ be projection operators. Then $\mathbf{P}_1 + \mathbf{P}_2$ is a projection operator if and only if \mathbf{P}_1 and \mathbf{P}_2 are orthogonal.*

More generally, if there is a set $\{\mathbf{P}_i\}_{i=1}^m$ of projection operators satisfying

$$\mathbf{P}_i\mathbf{P}_j = \begin{cases} \mathbf{P}_i & \text{if } i = j, \\ 0 & \text{if } i \neq j, \end{cases}$$

then $\mathbf{P} = \sum_{i=1}^m \mathbf{P}_i$ is also a projection operator.

Given a normal vector $|e\rangle$, one can show easily that $\mathbf{P} = |e\rangle\langle e|$ is a projection operator:

- \mathbf{P} is hermitian: $\mathbf{P}^\dagger = (|e\rangle\langle e|)^\dagger = (\langle e|)^\dagger(|e\rangle)^\dagger = |e\rangle\langle e|$.
- \mathbf{P} equals its square: $\mathbf{P}^2 = (|e\rangle\langle e|)(|e\rangle\langle e|) = |e\rangle \underbrace{\langle e|e\rangle}_{=1} \langle e| = |e\rangle\langle e|$.

Let $|y\rangle$ be any nonzero vector in an inner product space \mathcal{V} . The normal vector $|e_y\rangle$ along $|y\rangle$ is $|e_y\rangle = |y\rangle/\sqrt{\langle y|y\rangle}$. From this, we construct the projection operator \mathbf{P}_y along $|y\rangle$:

$$\mathbf{P}_y = |e_y\rangle\langle e_y| = \frac{|y\rangle}{\sqrt{\langle y|y\rangle}} \frac{\langle y|}{\sqrt{\langle y|y\rangle}} = \frac{|y\rangle\langle y|}{\langle y|y\rangle}.$$

Given any vector $|x\rangle$, $\mathbf{P}_y|x\rangle$ is the component of $|x\rangle$ along $|y\rangle$. Hence,

$$|x\rangle - \mathbf{P}_y|x\rangle \quad \text{or} \quad (\mathbf{1} - \mathbf{P}_y)|x\rangle$$

is the component of $|x\rangle$ perpendicular to $|y\rangle$. The reflection of $|x\rangle$ in $|y\rangle$ is therefore (see Fig. 4.2)

$$\mathbf{P}_y|x\rangle - (\mathbf{1} - \mathbf{P}_y)|x\rangle = 2\mathbf{P}_y|x\rangle - |x\rangle = (2\mathbf{P}_y - \mathbf{1})|x\rangle = 2\frac{\langle y|x\rangle}{\langle y|y\rangle}|y\rangle - |x\rangle.$$

As shown in Fig. 4.2, from a two- or three-dimensional geometric point of view, it is clear that the negative of this last vector is the reflection in the plane perpendicular to $|y\rangle$.¹² We generalize this to any vector space:

Definition 4.4.4 For any nonzero vector $|y\rangle$ the projection operator \mathbf{P}_y along $|y\rangle$ and the **reflection operator** \mathbf{R}_y in the plane perpendicular to $|y\rangle$ reflection operator

¹²One can note more directly—also shown in Fig. 4.2—that in three-dimensional geometry, if one adds to $|x\rangle$ twice the negative of its projection on $|y\rangle$, one gets the reflection of $|x\rangle$ in the plane perpendicular to $|y\rangle$.

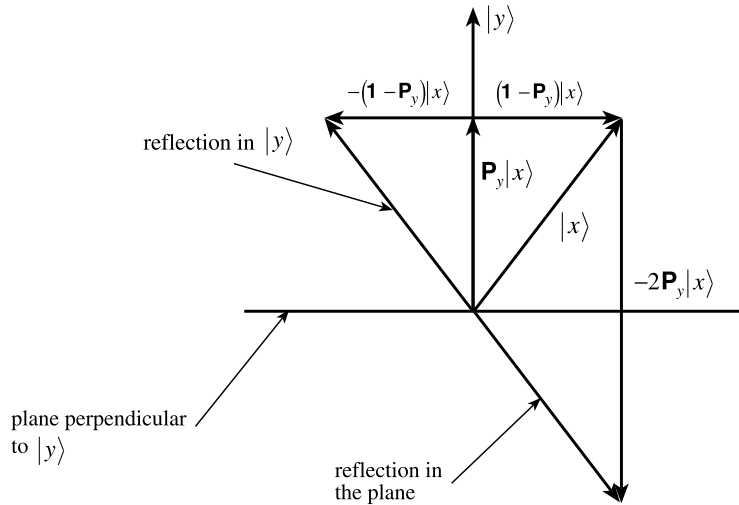

Fig. 4.2 The vectors $|x\rangle$ and $|y\rangle$ and the reflections of $|x\rangle$ in $|y\rangle$ and in the plane perpendicular to $|y\rangle$

are given by

$$\mathbf{P}_y = \frac{|y\rangle\langle y|}{\langle y|y\rangle} \quad \text{and} \quad \mathbf{R}_y = \mathbf{1} - 2\mathbf{P}_y = \mathbf{1} - 2\frac{|y\rangle\langle y|}{\langle y|y\rangle}.$$

For any other vector $|x\rangle$, the component $|x\rangle_y$ of $|x\rangle$ along $|y\rangle$ and its reflection $|x\rangle_{r,y}$ in the plane perpendicular to $|y\rangle$ are given by

$$|x\rangle_y = \mathbf{P}_y|x\rangle = \frac{\langle y|x\rangle}{\langle y|y\rangle}|y\rangle \quad \text{and} \quad |x\rangle_{r,y} = \mathbf{R}_y|x\rangle = |x\rangle - 2\frac{\langle y|x\rangle}{\langle y|y\rangle}|y\rangle.$$

The relations $|y\rangle_y = |y\rangle$ and $|y\rangle_{r,y} = -|y\rangle$ confirm our intuitive geometrical expectation.

Example 4.4.5 Let \mathcal{V} be a one-dimensional vector space. Let $|a\rangle$ be any nonzero vector in \mathcal{V} . Any other vector $|x\rangle$ can be written as $|x\rangle = \alpha|a\rangle$ for some number α . Then

$$\mathbf{P}_a|x\rangle = \frac{|a\rangle\langle a|}{\langle a|a\rangle}|x\rangle = \frac{\langle a|x\rangle}{\langle a|a\rangle}|a\rangle = \frac{\alpha\langle a|a\rangle}{\langle a|a\rangle}|a\rangle = \alpha|a\rangle = |x\rangle.$$

Since this is true for all $|a\rangle$ and $|x\rangle$, we conclude that $\mathbf{P}_y = \mathbf{1}$ for any $|y\rangle$ in a one-dimensional vector space. The reflection operator can also be found. Therefore,

$$\mathbf{P}_y = \mathbf{1} \quad \text{and} \quad \mathbf{R}_y = -\mathbf{1}$$

in a one-dimensional vector space such as the complex vector space \mathbb{C} and the real vector space \mathbb{R} .

We can take an orthonormal basis $B = \{|e_i\rangle\}_{i=1}^N$ and construct a set of projection operators $\{\mathbf{P}_i = |e_i\rangle\langle e_i|\}_{i=1}^N$. The operators \mathbf{P}_i are mutually orthogonal. Thus, their sum $\sum_{i=1}^N \mathbf{P}_i$ is also a projection operator.

Proposition 4.4.6 Let $B = \{|e_i\rangle\}_{i=1}^N$ be an orthonormal basis for \mathcal{V}_N . Then the set $\{\mathbf{P}_i = |e_i\rangle\langle e_i|\}_{i=1}^N$ consists of mutually orthogonal projection operators, and

completeness relation

$$\sum_{i=1}^N \mathbf{P}_i = \sum_{i=1}^N |e_i\rangle\langle e_i| = \mathbf{1}.$$

This relation is called the **completeness relation**.

Proof The proof is left as Problem 4.26. \square

If we choose only the first $m < N$ vectors, then the projection operator $\mathbf{P}^{(m)} \equiv \sum_{i=1}^m |e_i\rangle\langle e_i|$ projects arbitrary vectors into the subspace spanned by the first m basis vectors $\{|e_i\rangle\}_{i=1}^m$. In other words, when $\mathbf{P}^{(m)}$ acts on any vector $|a\rangle \in \mathcal{V}$, the result will be a linear combination of only the first m vectors. The simple proof of this fact is left as an exercise. These points are illustrated in the following example.

Example 4.4.7 Consider three orthonormal vectors $\{|e_i\rangle\}_{i=1}^3 \in \mathbb{R}^3$ given by

$$|e_1\rangle = \frac{1}{\sqrt{2}} \begin{pmatrix} 1 \\ 1 \\ 0 \end{pmatrix}, \quad |e_2\rangle = \frac{1}{\sqrt{6}} \begin{pmatrix} 1 \\ -1 \\ 2 \end{pmatrix}, \quad |e_3\rangle = \frac{1}{\sqrt{3}} \begin{pmatrix} -1 \\ 1 \\ 1 \end{pmatrix}.$$

The projection operators associated with each of these can be obtained by noting that $\langle e_i|$ is a row vector. Therefore,

$$\mathbf{P}_1 = |e_1\rangle\langle e_1| = \frac{1}{2} \begin{pmatrix} 1 \\ 1 \\ 0 \end{pmatrix} (1 \quad 1 \quad 0) = \frac{1}{2} \begin{pmatrix} 1 & 1 & 0 \\ 1 & 1 & 0 \\ 0 & 0 & 0 \end{pmatrix}.$$

Similarly,

$$\mathbf{P}_2 = \frac{1}{6} \begin{pmatrix} 1 \\ -1 \\ 2 \end{pmatrix} (1 \quad -1 \quad 2) = \frac{1}{6} \begin{pmatrix} 1 & -1 & 2 \\ -1 & 1 & -2 \\ 2 & -2 & 4 \end{pmatrix}$$

and

$$\mathbf{P}_3 = \frac{1}{3} \begin{pmatrix} -1 \\ 1 \\ 1 \end{pmatrix} (-1 \quad 1 \quad 1) = \frac{1}{3} \begin{pmatrix} 1 & -1 & -1 \\ -1 & 1 & 1 \\ -1 & 1 & 1 \end{pmatrix}.$$

Note that \mathbf{P}_i projects onto the line along $|e_i\rangle$. This can be tested by letting \mathbf{P}_i act on an arbitrary vector and showing that the resulting vector is perpendicular to the other two vectors. For example, let \mathbf{P}_2 act on an arbitrary column vector:

$$|a\rangle \equiv \mathbf{P}_2 \begin{pmatrix} x \\ y \\ z \end{pmatrix} = \frac{1}{6} \begin{pmatrix} 1 & -1 & 2 \\ -1 & 1 & -2 \\ 2 & -2 & 4 \end{pmatrix} \begin{pmatrix} x \\ y \\ z \end{pmatrix} = \frac{1}{6} \begin{pmatrix} x - y + 2z \\ -x + y - 2z \\ 2x - 2y + 4z \end{pmatrix}.$$

We verify that $|a\rangle$ is perpendicular to both $|e_1\rangle$ and $|e_3\rangle$:

$$\langle e_1|a\rangle = \frac{1}{\sqrt{2}} (1 \quad 1 \quad 0) \frac{1}{6} \begin{pmatrix} x - y + 2z \\ -x + y - 2z \\ 2x - 2y + 4z \end{pmatrix} = 0.$$

Similarly, $\langle e_3|a\rangle = 0$. So indeed, $|a\rangle$ is along $|e_2\rangle$.

We can find the operator that projects onto the plane formed by $|e_1\rangle$ and $|e_2\rangle$. This is

$$\mathbf{P}_1 + \mathbf{P}_2 = \frac{1}{3} \begin{pmatrix} 2 & 1 & 1 \\ 1 & 2 & -1 \\ 1 & -1 & 2 \end{pmatrix}.$$

When this operator acts on an arbitrary column vector, it produces a vector lying in the plane of $|e_1\rangle$ and $|e_2\rangle$, or perpendicular to $|e_3\rangle$:

$$|b\rangle \equiv (\mathbf{P}_1 + \mathbf{P}_2) \begin{pmatrix} x \\ y \\ z \end{pmatrix} = \frac{1}{3} \begin{pmatrix} 2 & 1 & 1 \\ 1 & 2 & -1 \\ 1 & -1 & 2 \end{pmatrix} \begin{pmatrix} x \\ y \\ z \end{pmatrix} = \frac{1}{3} \begin{pmatrix} 2x + y + z \\ x + 2y - z \\ x - y + 2z \end{pmatrix}.$$

It is easy to show that $\langle e_3|b\rangle = 0$. The operators that project onto the other two planes are obtained similarly. Finally, we verify easily that

$$\mathbf{P}_1 + \mathbf{P}_2 + \mathbf{P}_3 = \begin{pmatrix} 1 & 0 & 0 \\ 0 & 1 & 0 \\ 0 & 0 & 1 \end{pmatrix} = \mathbf{1},$$

i.e., that completeness relation holds.

Example 4.4.8 We want to find the most general projection and reflection operators in a real two-dimensional vector space \mathcal{V} . Without loss of generality, we assume that $\mathcal{V} = \mathbb{R}^2$, and consider a vector

$$|y\rangle = \begin{pmatrix} \eta_1 \\ \eta_2 \end{pmatrix}.$$

Then

$$\mathbf{P}_y = \frac{|y\rangle\langle y|}{\langle y|y\rangle} = \frac{1}{\eta_1^2 + \eta_2^2} \begin{pmatrix} \eta_1 \\ \eta_2 \end{pmatrix} (\eta_1 \quad \eta_2) = \frac{1}{\eta_1^2 + \eta_2^2} \begin{pmatrix} \eta_1^2 & \eta_1\eta_2 \\ \eta_1\eta_2 & \eta_2^2 \end{pmatrix}.$$

Let

$$\frac{\eta_1^2}{\eta_1^2 + \eta_2^2} \equiv \cos^2 \alpha \quad \Rightarrow \quad \frac{\eta_1}{\sqrt{\eta_1^2 + \eta_2^2}} = \pm \cos \alpha,$$

and

$$\frac{\eta_2^2}{\eta_1^2 + \eta_2^2} \equiv \sin^2 \alpha \quad \Rightarrow \quad \frac{\eta_2}{\sqrt{\eta_1^2 + \eta_2^2}} = \pm \sin \alpha.$$

If the product $\eta_1\eta_2$ is negative, we can define a new angle which is the negative of the old angle. This will change the sign of $\eta_1\eta_2$ and make it positive without changing the signs of η_1^2 and η_2^2 . Thus the most general projection operator in \mathbb{R}^2 is

$$\mathbf{P}_y = \begin{pmatrix} \cos^2 \alpha & \sin \alpha \cos \alpha \\ \sin \alpha \cos \alpha & \sin^2 \alpha \end{pmatrix}. \quad (4.16)$$

Now that we have the projection operator along $|y\rangle$, we can construct the reflection operator in a plane perpendicular to $|y\rangle$:

$$\begin{aligned} \mathbf{R}_y &= \mathbf{1} - 2\mathbf{P}_y = \begin{pmatrix} 1 & 0 \\ 0 & 1 \end{pmatrix} - 2 \begin{pmatrix} \cos^2 \alpha & \sin \alpha \cos \alpha \\ \sin \alpha \cos \alpha & \sin^2 \alpha \end{pmatrix} \\ &= \begin{pmatrix} 1 - 2\cos^2 \alpha & -2\sin \alpha \cos \alpha \\ -2\sin \alpha \cos \alpha & 1 - 2\sin^2 \alpha \end{pmatrix} = \begin{pmatrix} -\cos 2\alpha & -\sin 2\alpha \\ -\sin 2\alpha & \cos 2\alpha \end{pmatrix}. \end{aligned}$$

Defining $\phi = -2\alpha$, we see that a general reflection is of the form

$$\mathbf{R}_\phi = \begin{pmatrix} -\cos \phi & \sin \phi \\ \sin \phi & \cos \phi \end{pmatrix}.$$

It is interesting to note that

$$\mathbf{R}_{\phi_1} \mathbf{R}_{\phi_2} = \begin{pmatrix} \cos(\phi_2 - \phi_1) & -\sin(\phi_2 - \phi_1) \\ \sin(\phi_2 - \phi_1) & \cos(\phi_2 - \phi_1) \end{pmatrix}.$$

The product of two reflections in \mathbb{R}^2 is a rotation.

This matrix describes a rotation of angle $\phi_2 - \phi_1$ in \mathbb{R}^2 (see Problem 5.9 in Chap. 5), which is clearly an isometry. We have just shown that the product of two reflections is an isometry. It turns out that this is a general property of isometries: they can always be expressed as a product of reflections (see Theorem 26.5.17).

4.5 Representation of Algebras

The operator algebra, i.e., the algebra $\mathcal{L}(\mathcal{V})$ of the endomorphisms of a vector space, plays a significant role in physical applications as demonstrated so far in this chapter. These (abstract) operators take on a concrete (numerical) look once they are identified as matrices, the topic of Chap. 5. This suggests making an identification of any given algebra with a (sub)algebra of $\mathcal{L}(\mathcal{V})$, which subsequently could be identified as a collection of numbers—what physicists are after—constituting the rows and columns of matrices. The vague notion of “identification” is made precise by the concept of homomorphism of algebras.

For the following definition, it is convenient to introduce some notation. Let both \mathbb{F} and \mathbb{K} denote either \mathbb{R} or \mathbb{C} with the condition that $\mathbb{F} \subseteq \mathbb{K}$. So, for instance, when $\mathbb{F} = \mathbb{R}$, then \mathbb{K} can be either \mathbb{R} and \mathbb{C} ; but when $\mathbb{F} = \mathbb{C}$, then \mathbb{K} can be only \mathbb{C} . If \mathcal{V} is a vector space over \mathbb{K} , we denote the algebra

of its endomorphisms by $\mathcal{L}_{\mathbb{K}}(\mathcal{V})$ or $\text{End}_{\mathbb{K}}(\mathcal{V})$. When there is no danger of confusion, we remove the subscript \mathbb{K} .

representation of an algebra in a vector space

Definition 4.5.1 Let \mathcal{A} be an associative algebra over \mathbb{F} with identity $\mathbf{1}_{\mathcal{A}}$. A \mathbb{K} -**representation** of \mathcal{A} in a vector space \mathcal{V} over \mathbb{K} is a homomorphism $\rho : \mathcal{A} \rightarrow \text{End}_{\mathbb{K}}(\mathcal{V})$ such that $\rho(\mathbf{1}_{\mathcal{A}}) = \mathbf{1}$, where $\mathbf{1}$ is the unit operator in $\text{End}_{\mathbb{K}}(\mathcal{V})$. The representation ρ is said to be **faithful** if it is injective.

Proposition 4.5.2 A nontrivial representation of a simple algebra is faithful.

Proof Since any representation is a homomorphism, the proof follows immediately from Proposition 3.2.14. \square

a representation of the algebra of quaternions

Example 4.5.3 Let $\mathcal{A} = \mathbb{H}$, the (real) algebra of the quaternions, i.e., elements of the form

$$q = q_0\mathbf{e}_0 + q_1\mathbf{e}_1 + q_2\mathbf{e}_2 + q_3\mathbf{e}_3, \quad q_i \in \mathbb{R}$$

as given in Example 3.1.16. Let $\mathcal{V} = \mathbb{R}^4$. Consider $\rho : \mathbb{H} \rightarrow \text{End}_{\mathbb{R}}(\mathbb{R}^4)$, the real representation of quaternions given by

$$\begin{aligned} \mathbf{T}_q|x\rangle &\equiv \mathbf{T}_q \begin{pmatrix} x_1 \\ x_2 \\ x_3 \\ x_4 \end{pmatrix} = \begin{pmatrix} q_0x_1 - q_1x_2 - q_2x_3 - q_3x_4 \\ q_1x_1 + q_0x_2 - q_3x_3 + q_2x_4 \\ q_2x_1 + q_3x_2 + q_0x_3 - q_1x_4 \\ q_3x_1 - q_2x_2 + q_1x_3 + q_0x_4 \end{pmatrix} \\ &= \begin{pmatrix} q_0 & -q_1 & -q_2 & -q_3 \\ q_1 & q_0 & -q_3 & q_2 \\ q_2 & q_3 & q_0 & -q_1 \\ q_3 & -q_2 & q_1 & q_0 \end{pmatrix} \begin{pmatrix} x_1 \\ x_2 \\ x_3 \\ x_4 \end{pmatrix} \end{aligned}$$

where $\mathbf{T}_q \equiv \rho(q) \in \mathcal{L}(\mathbb{R}^4)$, and for convenience, we have written the element of \mathbb{R}^4 as a column vector and introduced the matrix of q 's. With this matrix, we can simply write

$$\rho(q) = \begin{pmatrix} q_0 & -q_1 & -q_2 & -q_3 \\ q_1 & q_0 & -q_3 & q_2 \\ q_2 & q_3 & q_0 & -q_1 \\ q_3 & -q_2 & q_1 & q_0 \end{pmatrix}. \quad (4.17)$$

Using this matrix, it is straightforward, but slightly tedious, to show directly that $\rho(qp) = \rho(q)\rho(p)$. Hence, ρ is indeed a representation of \mathbb{H} . However, instead, we calculate the matrices corresponding to the basis vectors of \mathbb{H} . Since $q_0 = 1$ and $q_1 = q_2 = q_3 = 0$ for \mathbf{e}_0 , we get $\rho(\mathbf{e}_0) = \mathbf{1}$, as we should,

and as is evident from (4.17). Similarly, we can calculate the matrices of the other basis vectors. The results are given below

$$\begin{aligned} \rho(\mathbf{e}_0) &= \begin{pmatrix} 1 & 0 & 0 & 0 \\ 0 & 1 & 0 & 0 \\ 0 & 0 & 1 & 0 \\ 0 & 0 & 0 & 1 \end{pmatrix}, & \rho(\mathbf{e}_1) &= \begin{pmatrix} 0 & -1 & 0 & 0 \\ 1 & 0 & 0 & 0 \\ 0 & 0 & 0 & -1 \\ 0 & 0 & 1 & 0 \end{pmatrix}, \\ \rho(\mathbf{e}_2) &= \begin{pmatrix} 0 & 0 & -1 & 0 \\ 0 & 0 & 0 & 1 \\ 1 & 0 & 0 & 0 \\ 0 & -1 & 0 & 0 \end{pmatrix}, & \rho(\mathbf{e}_3) &= \begin{pmatrix} 0 & 0 & -1 \\ 0 & 0 & -1 & 0 \\ 0 & 1 & 0 & 0 \\ 1 & 0 & 0 & 0 \end{pmatrix}. \end{aligned}$$

It is now easier to check that $\rho(\mathbf{e}_i\mathbf{e}_j) = \rho(\mathbf{e}_i)\rho(\mathbf{e}_j)$ for $i, j = 0, 1, 2, 3$, and hence, by Proposition 3.1.19, that ρ is indeed a representation.

Definition 4.5.4 A subspace \mathcal{W} of \mathcal{V} is called **stable** or **invariant** under a representation $\rho : \mathcal{A} \rightarrow \text{End}_{\mathbb{C}}(\mathcal{V}) \cong \text{End}(\mathcal{V})$ if $\rho(\mathbf{a})|w$ is in \mathcal{W} for all $|w\rangle \in \mathcal{W}$ and all $\mathbf{a} \in \mathcal{A}$. A representation ρ is called **irreducible** if the only stable subspaces are $\mathcal{W} = \mathcal{V}$ and $\mathcal{W} = \{|0\rangle_{\mathcal{V}}\}$.

stable, invariant, and irreducible subspaces

Problem 4.34 shows that if ρ is surjective, then it is irreducible.

Proposition 4.5.5 Let $\rho : \mathcal{A} \rightarrow \text{End}(\mathcal{V})$ be a representation and $|v\rangle$ an arbitrary nonzero vector in \mathcal{V} . Then

$$\mathcal{W} \equiv \rho(\mathcal{A})|v\rangle = \{|w\rangle \in \mathcal{V} \mid |w\rangle = \rho(\mathbf{a})|v\rangle \text{ for some } \mathbf{a} \in \mathcal{A}\}$$

is a stable subspace of \mathcal{V} . In particular, ρ is irreducible if and only if $\rho(\mathcal{A})|v\rangle = \mathcal{V}$.

Proof The straightforward but instructive proof is the content of Problem 4.37. □

Isomorphic vector spaces are indistinguishable. So can be their corresponding representations. More precisely,

Definition 4.5.6 Suppose $\mathbf{T} : \mathcal{V}_1 \cong \mathcal{V}_2$ is an isomorphism. Two representations $\rho_1 : \mathcal{A} \rightarrow \text{End}(\mathcal{V}_1)$ and $\rho_2 : \mathcal{A} \rightarrow \text{End}(\mathcal{V}_2)$ are called **equivalent** if

$$\mathbf{T} \circ \rho_1(\mathbf{a}) = \rho_2(\mathbf{a}) \circ \mathbf{T} \quad \text{for all } \mathbf{a} \in \mathcal{A}.$$

We write $\rho_1 \sim \rho_2$ to indicate the equivalence of the two representations.

equivalent representations

Sometimes the condition of equivalence is written as

$$\rho_1(\mathbf{a}) = \mathbf{T}^{-1} \circ \rho_2(\mathbf{a}) \circ \mathbf{T} \quad \text{or} \quad \rho_2(\mathbf{a}) = \mathbf{T} \circ \rho_1(\mathbf{a}) \circ \mathbf{T}^{-1}. \quad (4.18)$$

Just as we can combine two vector spaces to get a new vector space, we can combine two representations to obtain a new representation.

Definition 4.5.7 Let ρ and η be representations of \mathcal{A} in \mathcal{U} and \mathcal{V} , respectively. We define representations $\rho \oplus \eta$, called the **direct sum**, and $\rho \otimes \eta$, called the **tensor product**, of ρ and η , respectively in $\mathcal{U} \oplus \mathcal{V}$ and $\mathcal{U} \otimes \mathcal{V}$ by

$$\begin{aligned}
 (\rho \oplus \eta)(\mathbf{a}) &= \rho(\mathbf{a}) \oplus \eta(\mathbf{a}) \quad \mathbf{a} \in \mathcal{A} \\
 (\rho \otimes \eta)(\mathbf{a}) &= \rho(\mathbf{a}) \otimes \eta(\mathbf{a}) \quad \mathbf{a} \in \mathcal{A}.
 \end{aligned}$$

It should be obvious that if $\rho_1 \sim \rho_2$ and $\eta_1 \sim \eta_2$, then $\rho_1 \oplus \eta_1 \sim \rho_2 \oplus \eta_2$ and $\rho_1 \otimes \eta_1 \sim \rho_2 \otimes \eta_2$.

using $|a\rangle$ and \mathbf{a} in certain representations of an algebra

Since an algebra \mathcal{A} is also a vector space, it is possible to come up with representations of the form $\rho : \mathcal{A} \rightarrow \text{End}(\mathcal{A})$. When there is no danger of confusion, we designate members of \mathcal{A} as a ket when they are considered simply as vectors, but use bold face type when the same member participates in an algebra multiplication. Thus $|a\rangle \in \mathcal{A}$ when the member is considered as a vector and $\mathbf{a} \in \mathcal{A}$ when the same member is one of the factors in a product.

regular representation of an algebra

Definition 4.5.8 The **regular representation** of \mathcal{A} in \mathcal{A} is the representation $\rho_L : \mathcal{A} \rightarrow \text{End}(\mathcal{A})$ given by $\rho_L(\mathbf{a})|b\rangle = \mathbf{a}b$.

It is trivial to show that this is indeed a representation, i.e., that $\rho_L(\mathbf{a}\mathbf{b}) = \rho_L(\mathbf{a})\rho_L(\mathbf{b})$.

If \mathcal{A} is unital, then $\rho_L(\mathbf{a}) = \rho_L(\mathbf{a}')$ implies that $\rho_L(\mathbf{a})|1\rangle = \rho_L(\mathbf{a}')|1\rangle$ or that $\mathbf{a}1 = \mathbf{a}'1$, namely that $\mathbf{a} = \mathbf{a}'$, indicating that ρ_L is injective, and the representation faithful, or $\rho_L(\mathcal{A}) \cong \mathcal{A}$.

ρ_L is simply the left-multiplication of \mathcal{A} . What about the right-multiplication? If we set $\rho_R(\mathbf{a})|b\rangle = \mathbf{b}\mathbf{a}$, then

$$\begin{aligned}
 \rho_R(\mathbf{a}\mathbf{b})|c\rangle &= \mathbf{c}\mathbf{a}\mathbf{b} = (\mathbf{c}\mathbf{a})\mathbf{b} = (\rho_R(\mathbf{a})|c\rangle)\mathbf{b} = \rho_R(\mathbf{b})(\rho_R(\mathbf{a})|c\rangle) \\
 &= (\rho_R(\mathbf{b})\rho_R(\mathbf{a}))|c\rangle.
 \end{aligned}$$

Hence, $\rho_R(\mathbf{a}\mathbf{b}) = \rho_R(\mathbf{b})\rho_R(\mathbf{a})$. Again if \mathcal{A} is unital, then ρ_R is faithful and $\rho_R(\mathcal{A}) \cong \mathcal{A}^{\text{op}}$, where \mathcal{A}^{op} is the algebra opposite to \mathcal{A} given in Definition 3.1.8.

Theorem 4.5.9 Let \mathcal{L} be a minimal left ideal of an algebra \mathcal{A} . Then the representation $\rho^{(\mathcal{L})} : \mathcal{A} \rightarrow \text{End}(\mathcal{L})$, the regular representation of \mathcal{A} in \mathcal{L} , given by

$$\rho^{(\mathcal{L})}(\mathbf{a})|x\rangle \equiv \rho_L(\mathbf{a})|x\rangle = \mathbf{a}\mathbf{x} \quad \text{for } \mathbf{a} \in \mathcal{A} \text{ and } |x\rangle \equiv \mathbf{x} \in \mathcal{L},$$

is irreducible.

Proof We note that $\rho^{(\mathcal{L})}(\mathcal{A})|x\rangle = \mathcal{A}\mathbf{x}$. Since \mathcal{L} is minimal, $\mathcal{A}\mathbf{x} = \mathcal{L}$ by Theorem 3.2.6, and $\rho^{(\mathcal{L})}(\mathcal{A})|x\rangle = \mathcal{L}$. By Proposition 4.5.5, $\rho^{(\mathcal{L})}$ is irreducible. \square

Theorem 4.5.10 *All irreducible representations of a simple algebra \mathcal{A} are faithful and equivalent to $\rho^{(\mathcal{L})}$, the regular representation of \mathcal{A} in the minimal left ideal \mathcal{L} .*

Proof The faithfulness is a consequence of Proposition 4.5.2. Let $\rho : \mathcal{A} \rightarrow \text{End}(\mathcal{V})$ be an irreducible representation. For $\mathbf{x} \in \mathcal{L}$ and a vector $|e\rangle \in \mathcal{V}$, let $\rho(\mathbf{x})|e\rangle = |v\rangle$. Then

$$\rho(\mathcal{L})|e\rangle = \rho(\mathcal{A}\mathbf{x})|e\rangle = \rho(\mathcal{A})\rho(\mathbf{x})|e\rangle = \rho(\mathcal{A})|v\rangle = \mathcal{V}. \quad (4.19)$$

The first equality follows from Theorem 3.2.6, and the last equality from Proposition 4.5.5.

Now consider a linear map $\mathbf{T} : \mathcal{L} \rightarrow \mathcal{V}$ given by $\mathbf{T}(\mathbf{y}) = \rho(\mathbf{y})|e\rangle$, and note that by Eq. (4.19),

$$\mathbf{T}(\mathcal{L}) = \rho(\mathcal{L})|e\rangle = \mathcal{V}.$$

Therefore, \mathbf{T} is surjective. Now let \mathbf{z} be a nonzero member of \mathcal{L} . If $\mathbf{z} \in \ker \mathbf{T}$, then by Theorem 3.2.6, $\mathcal{L} = \mathcal{A}\mathbf{z}$ and

$$\mathbf{T}(\mathcal{L}) = \rho(\mathcal{L})|e\rangle = \rho(\mathcal{A}\mathbf{z})|e\rangle = \rho(\mathcal{A})\rho(\mathbf{z})|e\rangle = \rho(\mathcal{A})\mathbf{T}(\mathbf{z}) = \{\mathbf{0}\}$$

which contradicts the previous equation. Therefore, $\ker \mathbf{T} = \{\mathbf{0}\}$ and \mathbf{T} is injective, hence, bijective.

To complete the proof, we have to show that

$$\mathbf{T} \circ \rho^{(\mathcal{L})}(\mathbf{a}) = \rho(\mathbf{a}) \circ \mathbf{T} \quad \text{for all } \mathbf{a} \in \mathcal{A}.$$

If $\mathbf{y} \in \mathcal{L}$, then the right-hand side gives

$$\rho(\mathbf{a}) \circ \mathbf{T}(\mathbf{y}) = \rho(\mathbf{a})\rho(\mathbf{y})|e\rangle = \rho(\mathbf{a}\mathbf{y})|e\rangle = \mathbf{T}(\mathbf{a}\mathbf{y}),$$

while the left-hand side yields

$$(\mathbf{T} \circ \rho^{(\mathcal{L})}(\mathbf{a}))\mathbf{y} = \mathbf{T}(\rho^{(\mathcal{L})}(\mathbf{a})\mathbf{y}) = \mathbf{T}(\mathbf{a}\mathbf{y}).$$

This completes the proof. \square

A consequence of this theorem is

Corollary 4.5.11 *All minimal left ideals of a simple algebra are isomorphic.*

Proof If \mathcal{L}' is another left ideal of \mathcal{A} , then let $\mathcal{V} = \mathcal{L}'$ in Theorem 4.5.10. Then \mathbf{T} of the theorem establishes an isomorphism between \mathcal{L} and \mathcal{L}' . \square

Theorem 4.5.12 *Two irreducible representations of a semi-simple algebra are equivalent if and only if they have the same kernel.*

Proof Recall from Theorem 3.5.25 that a semi-simple algebra \mathcal{A} is the direct sum of simple algebras, each component being an ideal of \mathcal{A} . Let

$$\mathcal{A} = \mathcal{J}_1 \oplus \mathcal{J}_2 \oplus \cdots \oplus \mathcal{J}_r = \bigoplus_{i=1}^r \mathcal{J}_i$$

and $\rho : \mathcal{A} \rightarrow \text{End}(\mathcal{V})$ be an irreducible representation. Assume there is $\mathbf{0} \neq \mathbf{x}_p \in \mathcal{J}_p$ for some p and $|e\rangle \in \mathcal{V}$ such that $|v\rangle \equiv \rho(\mathbf{x}_p)|e\rangle \neq |0\rangle$. Then since ρ is irreducible, by Proposition 4.5.5

$$\mathcal{V} = \rho(\mathcal{A})|v\rangle = \rho(\mathcal{A})\rho(\mathbf{x}_p)|e\rangle = \rho(\mathcal{A}\mathbf{x}_p)|e\rangle \subseteq \rho(\mathcal{J}_p)|e\rangle.$$

But obviously, $\rho(\mathcal{J}_p)|e\rangle \subseteq \mathcal{V}$. Hence,

$$\rho(\mathcal{J}_p)|e\rangle = \mathcal{V}, \quad (4.20)$$

which also indicates that any $|x\rangle \in \mathcal{V}$ can be written as $|x\rangle = \rho(\mathbf{y}_p)|e\rangle$ for some $\mathbf{y}_p \in \mathcal{J}_p$. Now since, $\mathcal{J}_p\mathcal{J}_k = \mathcal{J}_k\mathcal{J}_p = \{\mathbf{0}\}$ for $k \neq p$, we have

$$\rho(\mathbf{z}_k)|x\rangle = \rho(\mathbf{z}_k)\rho(\mathbf{y}_p)|e\rangle = \rho(\mathbf{z}_k\mathbf{y}_p)|e\rangle = \rho(\mathbf{0})|e\rangle = |0\rangle$$

for all $|x\rangle \in \mathcal{V}$. It follows that $\rho(\mathbf{z}_k)$ is the zero operator, i.e., $\mathbf{z}_k \in \ker \rho$ for all $k \neq p$, or

$$\bigoplus_{\substack{i=1 \\ i \neq p}}^r \mathcal{J}_i \subseteq \ker \rho.$$

Now let $\rho|_{\mathcal{J}_p} : \mathcal{J}_p \rightarrow \text{End}(\mathcal{V})$ be the restriction of ρ to \mathcal{J}_p , i.e., a representation of \mathcal{J}_p in \mathcal{V} . Then $\mathbf{T} : \mathcal{J}_p \rightarrow \mathcal{V}$ given by $\mathbf{T}(\mathbf{z}_p) = \rho(\mathbf{z}_p)|e\rangle$ is an isomorphism by the proof of Theorem 4.5.10. Hence, $\rho(\mathbf{z}_p) = \mathbf{0}$ implies that $\mathbf{z}_p = \mathbf{0}$, i.e., that $\mathcal{J}_p \cap \ker \rho = \{\mathbf{0}\}$. This yields

$$\bigoplus_{\substack{i=1 \\ i \neq p}}^r \mathcal{J}_i = \ker \rho.$$

Let $\rho_1 : \mathcal{A} \rightarrow \text{End}(\mathcal{V}_1)$ and $\rho_2 : \mathcal{A} \rightarrow \text{End}(\mathcal{V}_2)$ be two irreducible representations of a semi-simple algebra \mathcal{A} . Assume further that ρ_1 and ρ_2 have the same kernel; i.e. that for some $1 \leq p \leq r$,

$$\ker \rho_1 = \ker \rho_2 = \bigoplus_{\substack{i=1 \\ i \neq p}}^r \mathcal{J}_i.$$

Then as shown above there are isomorphisms $\mathbf{T}_1 : \mathcal{J}_p \rightarrow \mathcal{V}_1$ and $\mathbf{T}_2 : \mathcal{J}_p \rightarrow \mathcal{V}_2$ given by

$$\mathbf{T}_1(\mathbf{z}_p) = \rho_1(\mathbf{z}_p)|e_1\rangle, \quad \text{and} \quad \mathbf{T}_2(\mathbf{z}_p) = \rho_2(\mathbf{z}_p)|e_2\rangle$$

with

$$\rho_1(\mathcal{J}_p)|e_1\rangle = \mathcal{V}_1 \quad \text{and} \quad \rho_2(\mathcal{J}_p)|e_2\rangle = \mathcal{V}_2 \quad (4.21)$$

as in Eq. (4.20). The composite map $\mathbf{S} \equiv \mathbf{T}_2 \circ \mathbf{T}_1^{-1}$ maps \mathcal{V}_1 isomorphically onto \mathcal{V}_2 . We now show that

$$\mathbf{S} \circ \rho_1(\mathbf{a}) = \rho_2(\mathbf{a}) \circ \mathbf{S} \quad \text{for all } \mathbf{a} \in \mathcal{A},$$

and hence that $\rho_1 \sim \rho_2$. Applying the right-hand side of this equation on a $|v_1\rangle \in \mathcal{V}_1$, and noting that by (4.21) $|v_1\rangle = \rho_1(\mathbf{z}_p)|e_1\rangle$ for some $\mathbf{z}_p \in \mathcal{J}_p$, we get

$$\begin{aligned} \rho_2(\mathbf{a}) \circ \mathbf{S}|v_1\rangle &= \rho_2(\mathbf{a}) \circ (\mathbf{T}_2 \circ \mathbf{T}_1^{-1})\rho_1(\mathbf{z}_p)|e_1\rangle = \rho_2(\mathbf{a}) \circ \mathbf{T}_2(\mathbf{T}_1^{-1}\rho_1(\mathbf{z}_p)|e_1\rangle) \\ &= (\rho_2(\mathbf{a}) \circ \mathbf{T}_2(\mathbf{z}_p)) = \rho_2(\mathbf{a})\rho_2(\mathbf{z}_p)|e_2\rangle = \rho_2(\mathbf{az}_p)|e_2\rangle, \end{aligned}$$

while the left-hand side gives

$$\begin{aligned} \mathbf{S} \circ \rho_1(\mathbf{a})|v_1\rangle &= (\mathbf{T}_2 \circ \mathbf{T}_1^{-1})\rho_1(\mathbf{a})\rho_1(\mathbf{z}_p)|e_1\rangle = (\mathbf{T}_2 \circ \mathbf{T}_1^{-1})\rho_1(\mathbf{az}_p)|e_1\rangle \\ &= \mathbf{T}_2(\mathbf{T}_1^{-1}\rho_1(\mathbf{az}_p)|e_1\rangle) = \mathbf{T}_2(\mathbf{az}_p) = \rho_2(\mathbf{az}_p)|e_2\rangle. \end{aligned}$$

We have shown that if two irreducible representations of a semi-simple algebra have the same kernel, then they are equivalent. The converse is much easier to prove (see Problem 4.36). \square

4.6 Problems

4.1 Consider a linear operator \mathbf{T} on a finite-dimensional vector space \mathcal{V} .

- Show that there exists a polynomial p such that $p(\mathbf{T}) = \mathbf{0}$. Hint: Take a basis $B = \{|a_i\rangle\}_{i=1}^N$ and consider the vectors $\{\mathbf{T}^k|a_1\rangle\}_{k=0}^M$ for large enough M and conclude that there exists a polynomial $p_1(\mathbf{T})$ such that $p_1(\mathbf{T})|a_1\rangle = \mathbf{0}$. Do the same for $|a_2\rangle$, etc. Now take the product of all such polynomials.
- From (a) conclude that for large enough n , \mathbf{T}^n can be written as a linear combination of smaller powers of \mathbf{T} .
- Now conclude that any infinite series in \mathbf{T} collapses to a polynomial in \mathbf{T} .

4.2 Use mathematical induction to show that $[\mathbf{A}, \mathbf{A}^m] = \mathbf{0}$.

4.3 For \mathbf{D} and \mathbf{T} defined in Example 2.3.5:

- Show that $[\mathbf{D}, \mathbf{T}] = \mathbf{1}$.
- Calculate the linear transformations $\mathbf{D}^3\mathbf{T}^3$ and $\mathbf{T}^3\mathbf{D}^3$.

4.4 Consider three linear operators \mathbf{L}_1 , \mathbf{L}_2 , and \mathbf{L}_3 satisfying the commutation relations $[\mathbf{L}_1, \mathbf{L}_2] = i\mathbf{L}_3$, $[\mathbf{L}_3, \mathbf{L}_1] = i\mathbf{L}_2$, $[\mathbf{L}_2, \mathbf{L}_3] = i\mathbf{L}_1$, and define the new operators $\mathbf{L}_\pm = \mathbf{L}_1 \pm i\mathbf{L}_2$.

- (a) Show that the operator $\mathbf{L}^2 \equiv \mathbf{L}_1^2 + \mathbf{L}_2^2 + \mathbf{L}_3^2$ commutes with \mathbf{L}_k , $k = 1, 2, 3$.
- (b) Show that the set $\{\mathbf{L}_+, \mathbf{L}_-, \mathbf{L}_3\}$ is closed under commutation, i.e., the commutator of any two of them can be written as a linear combination of the set. Determine these commutators.
- (c) Write \mathbf{L}^2 in terms of \mathbf{L}_+ , \mathbf{L}_- , and \mathbf{L}_3 .

4.5 Prove the rest of Proposition 4.1.8.

4.6 Show that if $[[\mathbf{A}, \mathbf{B}], \mathbf{A}] = \mathbf{0}$, then for every positive integer k ,

$$[\mathbf{A}^k, \mathbf{B}] = k\mathbf{A}^{k-1}[\mathbf{A}, \mathbf{B}].$$

Hint: First prove the relation for low values of k ; then use mathematical induction.

4.7 Show that for \mathbf{D} and \mathbf{T} defined in Example 2.3.5,

$$[\mathbf{D}^k, \mathbf{T}] = k\mathbf{D}^{k-1} \quad \text{and} \quad [\mathbf{T}^k, \mathbf{D}] = -k\mathbf{T}^{k-1}.$$

4.8 Evaluate the derivative of $\mathbf{H}^{-1}(t)$ in terms of the derivative of $\mathbf{H}(t)$ by differentiating their product.

4.9 Show that for any $\alpha, \beta \in \mathbb{R}$ and any $\mathbf{H} \in \text{End}(\mathcal{V})$, we have

$$e^{\alpha\mathbf{H}}e^{\beta\mathbf{H}} = e^{(\alpha+\beta)\mathbf{H}}.$$

4.10 Show that $(\mathbf{U} + \mathbf{T})(\mathbf{U} - \mathbf{T}) = \mathbf{U}^2 - \mathbf{T}^2$ if and only if $[\mathbf{U}, \mathbf{T}] = \mathbf{0}$.

4.11 Prove that if \mathbf{A} and \mathbf{B} are hermitian, then $i[\mathbf{A}, \mathbf{B}]$ is also hermitian.

4.12 Find the solution to the operator differential equation

$$\frac{d\mathbf{U}}{dt} = t\mathbf{H}\mathbf{U}(t).$$

Hint: Make the change of variable $y = t^2$ and use the result of Example 4.2.3.

4.13 Verify that

$$\frac{d}{dt}\mathbf{H}^3 = \left(\frac{d\mathbf{H}}{dt}\right)\mathbf{H}^2 + \mathbf{H}\left(\frac{d\mathbf{H}}{dt}\right)\mathbf{H} + \mathbf{H}^2\left(\frac{d\mathbf{H}}{dt}\right).$$

4.14 Show that if \mathbf{A} and \mathbf{B} commute, and f and g are arbitrary functions, then $f(\mathbf{A})$ and $g(\mathbf{B})$ also commute.

4.15 Assuming that $[[\mathbf{S}, \mathbf{T}], \mathbf{T}] = \mathbf{0} = [[\mathbf{S}, \mathbf{T}], \mathbf{S}]$, show that

$$[\mathbf{S}, \exp(t\mathbf{T})] = t[\mathbf{S}, \mathbf{T}]\exp(t\mathbf{T}).$$

Hint: Expand the exponential and use Problem 4.6.

4.16 Prove that

$$\exp(\mathbf{H}_1 + \mathbf{H}_2 + \mathbf{H}_3) = \exp(\mathbf{H}_1) \exp(\mathbf{H}_2) \exp(\mathbf{H}_3) \\ \times \exp\left\{-\frac{1}{2}([\mathbf{H}_1, \mathbf{H}_2] + [\mathbf{H}_1, \mathbf{H}_3] + [\mathbf{H}_2, \mathbf{H}_3])\right\}$$

provided that \mathbf{H}_1 , \mathbf{H}_2 , and \mathbf{H}_3 commute with all the commutators. What is the generalization to $\mathbf{H}_1 + \mathbf{H}_2 + \cdots + \mathbf{H}_n$?

4.17 Denoting the derivative of $\mathbf{A}(t)$ by $\dot{\mathbf{A}}$, show that

$$\frac{d}{dt}[\mathbf{A}, \mathbf{B}] = [\dot{\mathbf{A}}, \mathbf{B}] + [\mathbf{A}, \dot{\mathbf{B}}].$$

4.18 Prove Theorem 4.3.2. Hint: Use Eq. (4.11) and Theorem 2.3.7.

4.19 Let $\mathbf{A}(t) \equiv \exp(t\mathbf{H})\mathbf{A}_0 \exp(-t\mathbf{H})$, where \mathbf{H} and \mathbf{A}_0 are constant operators. Show that $d\mathbf{A}/dt = [\mathbf{H}, \mathbf{A}(t)]$. What happens when \mathbf{H} commutes with $\mathbf{A}(t)$?

4.20 Let $|f\rangle, |g\rangle \in \mathbb{C}(a, b)$ with the additional property that

$$f(a) = g(a) = f(b) = g(b) = 0.$$

Show that for such functions, the derivative operator \mathbf{D} is anti-hermitian. The inner product is defined as usual:

$$\langle f|g\rangle \equiv \int_a^b f^*(t)g(t) dt.$$

4.21 In this problem, you will go through the steps of proving the rigorous statement of the **Heisenberg uncertainty principle**. Denote the expectation (average) value of an operator \mathbf{A} in a state $|\Psi\rangle$ by A_{avg} . Thus, $A_{\text{avg}} = \langle A \rangle = \langle \Psi|\mathbf{A}|\Psi\rangle$. The *uncertainty* (deviation from the mean) in the normalized state $|\Psi\rangle$ of the operator \mathbf{A} is given by

$$\Delta A = \sqrt{\langle (A - A_{\text{avg}})^2 \rangle} = \sqrt{\langle \Psi|(\mathbf{A} - A_{\text{avg}}\mathbf{1})^2|\Psi\rangle}.$$

(a) Show that for any two *hermitian* operators \mathbf{A} and \mathbf{B} , we have

$$|\langle \Psi|\mathbf{A}\mathbf{B}|\Psi\rangle|^2 \leq \langle \Psi|\mathbf{A}^2|\Psi\rangle \langle \Psi|\mathbf{B}^2|\Psi\rangle.$$

Hint: Apply the Schwarz inequality to an appropriate pair of vectors.

(b) Using the above and the triangle inequality for complex numbers, show that

$$|\langle \Psi|[\mathbf{A}, \mathbf{B}]|\Psi\rangle|^2 \leq 4\langle \Psi|\mathbf{A}^2|\Psi\rangle \langle \Psi|\mathbf{B}^2|\Psi\rangle.$$

(c) Define the operators $\mathbf{A}' = \mathbf{A} - \alpha\mathbf{1}$, $\mathbf{B}' = \mathbf{B} - \beta\mathbf{1}$, where α and β are *real* numbers. Show that \mathbf{A}' and \mathbf{B}' are hermitian and $[\mathbf{A}', \mathbf{B}'] = [\mathbf{A}, \mathbf{B}]$.

- (d) Now use all the results above to show the celebrated uncertainty relation
- Heisenberg uncertainty principle
- $$(\Delta A)(\Delta B) \geq \frac{1}{2} |\langle \Psi | [\mathbf{A}, \mathbf{B}] | \Psi \rangle|.$$

What does this reduce to for position operator \mathbf{x} and momentum operator \mathbf{p} if $[\mathbf{x}, \mathbf{p}] = i\hbar$?

4.22 Show that $\mathbf{U} = \exp \mathbf{A}$ is unitary if \mathbf{A} is anti-hermitian. Furthermore, if \mathbf{A} commutes with \mathbf{A}^\dagger , then $\exp \mathbf{A}$ is unitary. Hint: Use Proposition 4.2.4 on $\mathbf{U}\mathbf{U}^\dagger = \mathbf{1}$ and $\mathbf{U}^\dagger\mathbf{U} = \mathbf{1}$

4.23 Find \mathbf{T}^\dagger for each of the following linear operators.

- (a) $\mathbf{T}: \mathbb{R}^2 \rightarrow \mathbb{R}^2$ given by

$$\mathbf{T} \begin{pmatrix} x \\ y \end{pmatrix} = \begin{pmatrix} x + y \\ x - y \end{pmatrix}.$$

- (b) $\mathbf{T}: \mathbb{R}^3 \rightarrow \mathbb{R}^3$ given by

$$\mathbf{T} \begin{pmatrix} x \\ y \\ z \end{pmatrix} = \begin{pmatrix} x + 2y - z \\ 3x - y + 2z \\ -x + 2y + 3z \end{pmatrix}.$$

- (c) $\mathbf{T}: \mathbb{R}^2 \rightarrow \mathbb{R}^2$ given by

$$\mathbf{T} \begin{pmatrix} x \\ y \end{pmatrix} = \begin{pmatrix} x \cos \theta - y \sin \theta \\ x \sin \theta + y \cos \theta \end{pmatrix},$$

where θ is a real number. What is $\mathbf{T}^\dagger \mathbf{T}$?

- (d) $\mathbf{T}: \mathbb{C}^2 \rightarrow \mathbb{C}^2$ given by

$$\mathbf{T} \begin{pmatrix} \alpha_1 \\ \alpha_2 \end{pmatrix} = \begin{pmatrix} \alpha_1 - i\alpha_2 \\ i\alpha_1 + \alpha_2 \end{pmatrix}.$$

- (e) $\mathbf{T}: \mathbb{C}^3 \rightarrow \mathbb{C}^3$ given by

$$\mathbf{T} \begin{pmatrix} \alpha_1 \\ \alpha_2 \\ \alpha_3 \end{pmatrix} = \begin{pmatrix} \alpha_1 + i\alpha_2 - 2i\alpha_3 \\ -2i\alpha_1 + \alpha_2 + i\alpha_3 \\ i\alpha_1 - 2i\alpha_2 + \alpha_3 \end{pmatrix}.$$

4.24 Show that if \mathbf{P} is a (hermitian) projection operator, so are $\mathbf{1} - \mathbf{P}$ and $\mathbf{U}^\dagger \mathbf{P} \mathbf{U}$ for any unitary operator \mathbf{U} .

4.25 For the vector

$$|a\rangle = \frac{1}{\sqrt{2}} \begin{pmatrix} 0 \\ 1 \\ -1 \\ 0 \end{pmatrix},$$

- (a) find the associated projection matrix, \mathbf{P}_a .
 (b) Verify that \mathbf{P}_a does project an arbitrary vector in \mathbb{C}^4 along $|a\rangle$.
 (c) Verify directly that the matrix $\mathbf{1} - \mathbf{P}_a$ is also a projection operator.

4.26 Prove Proposition 4.4.6

4.27 Let $|a_1\rangle \equiv \mathbf{a}_1 = (1, 1, -1)$ and $|a_2\rangle \equiv \mathbf{a}_2 = (-2, 1, -1)$.

- (a) Construct (in the form of a matrix) the projection operators \mathbf{P}_1 and \mathbf{P}_2 that project onto the directions of $|a_1\rangle$ and $|a_2\rangle$, respectively. Verify that they are indeed projection operators.
 (b) Construct (in the form of a matrix) the operator $\mathbf{P} = \mathbf{P}_1 + \mathbf{P}_2$ and verify directly that it is a projection operator.
 (c) Let \mathbf{P} act on an arbitrary vector (x, y, z) . What is the dot product of the resulting vector with the vector $\mathbf{a}_1 \times \mathbf{a}_2$? What can you say about \mathbf{P} and your conclusion in (b)?

4.28 Let $\mathbf{P}^{(m)} = \sum_{i=1}^m |e_i\rangle\langle e_i|$ be a projection operator constructed out of the first m orthonormal vectors of the basis $B = \{|e_i\rangle\}_{i=1}^N$ of \mathcal{V} . Show that $\mathbf{P}^{(m)}$ projects into the subspace spanned by the first m vectors in B .

4.29 What is the length of the projection of the vector $(3, 4, -4)$ onto a line whose parametric equation is $x = 2t + 1$, $y = -t + 3$, $z = t - 1$? Hint: Find a unit vector in the direction of the line and construct its projection operator.

4.30 The parametric equation of a line L in a coordinate system with origin O is

$$x = 2t + 1, \quad y = t + 1, \quad z = -2t + 2.$$

A point P has coordinates $(3, -2, 1)$.

- (a) Using the projection operators, find the length of the projection of \overline{OP} on the line L .
 (b) Find the vector whose beginning is P and ends perpendicularly on L .
 (c) From this vector calculate the distance from P to L .

4.31 Let the operator $\mathbf{U} : \mathbb{C}^2 \rightarrow \mathbb{C}^2$ be given by

$$\mathbf{U} \begin{pmatrix} \alpha_1 \\ \alpha_2 \end{pmatrix} = \begin{pmatrix} i \frac{\alpha_1}{\sqrt{2}} - i \frac{\alpha_2}{\sqrt{2}} \\ \frac{\alpha_1}{\sqrt{2}} + \frac{\alpha_2}{\sqrt{2}} \end{pmatrix}.$$

Find \mathbf{U}^\dagger and test if \mathbf{U} is unitary.

4.32 Show that the product of two unitary operators is always unitary, but the product of two hermitian operators is hermitian if and only if they commute.

4.33 Let \mathbf{S} be an operator that is both unitary and hermitian. Show that

- (a) \mathbf{S} is involutive (i.e., $\mathbf{S}^2 = \mathbf{1}$), and

(b) $\mathbf{S} = \mathbf{P}^+ - \mathbf{P}^-$, where \mathbf{P}^+ and \mathbf{P}^- are hermitian projection operators.

4.34 Show that if a representation $\rho : \mathcal{A} \rightarrow \mathcal{L}(\mathcal{V})$ is surjective, then it is irreducible. Hint: The operator $|a\rangle\langle a|$ is in $\mathcal{L}(\mathcal{V})$ for any $|a\rangle \in \mathcal{V}$.

4.35 Show that $\rho(\mathbf{e}_i \mathbf{e}_j) = \rho(\mathbf{e}_i) \rho(\mathbf{e}_j)$ for $i, j = 0, 1, 2, 3$ in Example 4.5.3.

4.36 Show that *any* two equivalent representations of *any* algebra have the same kernel.

4.37 To prove Proposition 4.5.5, first show that $\rho(\mathcal{A})|v\rangle$ is a subspace. Then prove that $\rho(\mathcal{A})\mathcal{W} \subset \mathcal{W}$. For the “only if” part of an irreducible representation, take $|v\rangle$ to be in any subspace of \mathcal{V} .

So far, our theoretical investigation has been dealing mostly with abstract vectors and abstract operators. As we have seen in examples and problems, concrete representations of vectors and operators are necessary in most applications. Such representations are obtained by choosing a basis and expressing all operations in terms of components of vectors and matrix representations of operators.

5.1 Representing Vectors and Operators

Let us choose a basis $B_V = \{|a_i\rangle\}_{i=1}^N$ of a vector space \mathcal{V}_N , and express an arbitrary vector $|x\rangle$ in this basis: $|x\rangle = \sum_{i=1}^N \xi_i |a_i\rangle$. We write

$$\mathbf{x} = \begin{pmatrix} \xi_1 \\ \xi_2 \\ \vdots \\ \xi_N \end{pmatrix} \tag{5.1}$$

and say that the column vector \mathbf{x} **represents** $|x\rangle$ **in** B_V . We can also have a linear transformation $\mathbf{A} \in \mathcal{L}(\mathcal{V}_N, \mathcal{W}_M)$ act on the basis vectors in B_V to give vectors in the M -dimensional vector space \mathcal{W}_M : $|w_k\rangle = \mathbf{A}|a_k\rangle$. The latter can be written as a linear combination of basis vectors $B_W = \{|b_j\rangle\}_{j=1}^M$ in \mathcal{W}_M :

representation of vectors

$$|w_1\rangle = \sum_{j=1}^M \alpha_{j1} |b_j\rangle, \quad |w_2\rangle = \sum_{j=1}^M \alpha_{j2} |b_j\rangle, \quad \dots, \quad |w_N\rangle = \sum_{j=1}^M \alpha_{jN} |b_j\rangle.$$

Note that the components have an extra subscript to denote which of the N vectors $\{|w_i\rangle\}_{i=1}^N$ they are representing. The components can be arranged in a column as before to give a representation of the corresponding vectors:

$$\mathbf{w}_1 = \begin{pmatrix} \alpha_{11} \\ \alpha_{21} \\ \vdots \\ \alpha_{M1} \end{pmatrix}, \quad \mathbf{w}_2 = \begin{pmatrix} \alpha_{12} \\ \alpha_{22} \\ \vdots \\ \alpha_{M2} \end{pmatrix}, \quad \dots, \quad \mathbf{w}_N = \begin{pmatrix} \alpha_{1N} \\ \alpha_{2N} \\ \vdots \\ \alpha_{MN} \end{pmatrix}.$$

The operator itself is determined by the collection of all these vectors, i.e., by a matrix. We write this as

$$\mathbf{A} = \begin{pmatrix} \alpha_{11} & \alpha_{12} & \dots & \alpha_{1N} \\ \alpha_{21} & \alpha_{22} & \dots & \alpha_{2N} \\ \vdots & \vdots & & \vdots \\ \alpha_{M1} & \alpha_{M2} & \dots & \alpha_{MN} \end{pmatrix} \quad (5.2)$$

representation of
operators

and call \mathbf{A} the **matrix representing \mathbf{A} in bases B_V and B_W** . This statement is also summarized symbolically as

$$\mathbf{A}|a_i\rangle = \sum_{j=1}^M \alpha_{ji} |b_j\rangle, \quad i = 1, 2, \dots, N. \quad (5.3)$$

We thus have the following rule:

Box 5.1.1 To find the matrix \mathbf{A} representing \mathbf{A} in bases $B_V = \{|a_i\rangle\}_{i=1}^N$ and $B_W = \{|b_j\rangle\}_{j=1}^M$, express $\mathbf{A}|a_i\rangle$ as a linear combination of the vectors in B_W . The components form the i th column of \mathbf{A} .

Now consider the vector $|y\rangle = \mathbf{A}|x\rangle$ in \mathcal{W}_M . This vector can be written in two ways: On the one hand, $|y\rangle = \sum_{j=1}^M \eta_j |b_j\rangle$. On the other hand,

$$\begin{aligned} |y\rangle = \mathbf{A}|x\rangle &= \mathbf{A} \sum_{i=1}^N \xi_i |a_i\rangle = \sum_{i=1}^N \xi_i \mathbf{A}|a_i\rangle \\ &= \sum_{i=1}^N \xi_i \left(\sum_{j=1}^M \alpha_{ji} |b_j\rangle \right) = \sum_{j=1}^M \left(\sum_{i=1}^N \xi_i \alpha_{ji} \right) |b_j\rangle. \end{aligned}$$

Since $|y\rangle$ has a unique set of components in the basis B_W , we conclude that

$$\eta_j = \sum_{i=1}^N \alpha_{ji} \xi_i, \quad j = 1, 2, \dots, M. \quad (5.4)$$

This is written as

$$\begin{pmatrix} \eta_1 \\ \eta_2 \\ \vdots \\ \eta_M \end{pmatrix} = \begin{pmatrix} \alpha_{11} & \alpha_{12} & \dots & \alpha_{1N} \\ \alpha_{21} & \alpha_{22} & \dots & \alpha_{2N} \\ \vdots & \vdots & & \vdots \\ \alpha_{M1} & \alpha_{M2} & \dots & \alpha_{MN} \end{pmatrix} \begin{pmatrix} \xi_1 \\ \xi_2 \\ \vdots \\ \xi_N \end{pmatrix} \Rightarrow \mathbf{y} = \mathbf{A}\mathbf{x}, \quad (5.5)$$

in which the usual matrix multiplication rule is understood. This matrix equation is the representation of the operator equation $|y\rangle = \mathbf{A}|x\rangle$ in the bases B_V and B_W .

The construction above indicates that—once the bases are fixed in the two vector spaces—to every operator there corresponds a *unique* matrix. This uniqueness is the result of the uniqueness of the components of vectors

in a basis. On the other hand, given an $M \times N$ matrix A with elements α_{ij} , one can construct a unique linear operator \mathbf{T}_A defined by its action on the basis vectors (see Box 2.3.6): $\mathbf{T}_A|a_i\rangle \equiv \sum_{j=1}^M \alpha_{ji}|b_j\rangle$. Thus, there is a one-to-one correspondence between operators and matrices. This correspondence is in fact a linear isomorphism:

The operator \mathbf{T}_A associated with a matrix A

Proposition 5.1.2 *The two vector spaces $\mathcal{L}(\mathcal{V}_N, \mathcal{W}_M)$ and $\mathcal{M}^{M \times N}$ are isomorphic. An explicit isomorphism is established only when a basis is chosen for each vector space, in which case, an operator is identified with its matrix representation.*

Example 5.1.3 In this example, we construct a matrix representation of the complex structure \mathbf{J} on a real vector space \mathcal{V} introduced in Sect. 2.4. There are two common representations, each corresponding to a different ordering of the vectors in the basis $\{|e_i\rangle, \mathbf{J}|e_i\rangle\}_{i=1}^m$ of \mathcal{V} . One ordering is to let $\mathbf{J}|e_i\rangle$ come right after $|e_i\rangle$. The other is to collect all the $\mathbf{J}|e_i\rangle$ after the $|e_i\rangle$ in the same order. We consider the first ordering in this example, and leave the other for the reader to construct.

matrix representation of the complex structure \mathbf{J}

In the first ordering, for each $|e_i\rangle$, we let $|e_{i+1}\rangle = \mathbf{J}|e_i\rangle$. Starting with $|e_1\rangle$, we have

$$\mathbf{J}|e_1\rangle = |e_2\rangle = 0 \cdot |e_1\rangle + 1 \cdot |e_2\rangle + 0 \cdot |e_3\rangle + \dots + 0 \cdot |e_{2m}\rangle,$$

$$\mathbf{J}|e_2\rangle = \mathbf{J}^2|e_1\rangle = -|e_1\rangle = -1 \cdot |e_1\rangle + 0 \cdot |e_2\rangle + 0 \cdot |e_3\rangle + \dots + 0 \cdot |e_{2m}\rangle.$$

These two equations give the first two columns as

$$\begin{pmatrix} 0 & -1 \\ 1 & 0 \\ 0 & 0 \\ \vdots & \vdots \\ 0 & 0 \end{pmatrix}.$$

For the third and fourth basis vectors, we get

$$\mathbf{J}|e_3\rangle = |e_4\rangle = 0 \cdot |e_1\rangle + 0 \cdot |e_2\rangle + 0 \cdot |e_3\rangle + 1 \cdot |e_4\rangle + \dots + 0 \cdot |e_{2m}\rangle$$

$$\mathbf{J}|e_4\rangle = \mathbf{J}^2|e_3\rangle = -|e_3\rangle = 0 \cdot |e_1\rangle + 0 \cdot |e_2\rangle - 1 \cdot |e_3\rangle + \dots + 0 \cdot |e_{2m}\rangle,$$

giving rise to the following third and fourth columns:

$$\begin{pmatrix} 0 & 0 \\ 0 & 0 \\ 0 & -1 \\ 1 & 0 \\ \vdots & \vdots \\ 0 & 0 \end{pmatrix}.$$

It should now be clear that the matrix representation of \mathbf{J} is of the form

$$\mathbf{J} = \begin{pmatrix} \mathbf{R}_1 & 0 & \dots & 0 \\ 0 & \mathbf{R}_2 & \dots & 0 \\ \vdots & \vdots & & \vdots \\ 0 & 0 & \dots & \mathbf{R}_m \end{pmatrix},$$

where the zeros are the 2×2 zero matrices and $\mathbf{R}_k = \begin{pmatrix} 0 & -1 \\ 1 & 0 \end{pmatrix}$ for all k .

Notation 5.1.4 Let $\mathbf{A} \in \mathcal{L}(\mathcal{V}_N, \mathcal{W}_M)$. Choose a bases B_V for \mathcal{V} and B_W for \mathcal{W} . We denote the matrix representing \mathbf{A} in these bases by $\mathbf{M}_{B_V}^{B_W}(\mathbf{A})$, where

$$\mathbf{M}_{B_V}^{B_W} : \mathcal{L}(\mathcal{V}_N, \mathcal{W}_M) \rightarrow \mathcal{M}^{M \times N}$$

is the basis-dependent linear isomorphism. When $\mathcal{V} = \mathcal{W}$, we leave out the subscripts and superscripts of \mathbf{M} , keeping in mind that all matrices are representations in a single basis.

Given the linear transformations $\mathbf{A} : \mathcal{V}_N \rightarrow \mathcal{W}_M$ and $\mathbf{B} : \mathcal{W}_M \rightarrow \mathcal{U}_K$, we can form the composite linear transformation $\mathbf{B} \circ \mathbf{A} : \mathcal{V}_N \rightarrow \mathcal{U}_K$. We can also choose bases $B_V = \{|a_i\rangle\}_{i=1}^N$, $B_W = \{|b_i\rangle\}_{i=1}^M$, $B_U = \{|c_i\rangle\}_{i=1}^K$ for \mathcal{V} , \mathcal{W} , and \mathcal{U} , respectively. Then \mathbf{A} , \mathbf{B} , and $\mathbf{B} \circ \mathbf{A}$ will be represented by an $M \times N$, a $K \times M$, and a $K \times N$ matrix, respectively, and we have

$$\mathbf{M}_{B_V}^{B_U}(\mathbf{B} \circ \mathbf{A}) = \mathbf{M}_{B_W}^{B_U}(\mathbf{B})\mathbf{M}_{B_V}^{B_W}(\mathbf{A}), \quad (5.6)$$

where on the right-hand side the product is defined as the usual product of matrices. If $\mathcal{V} = \mathcal{W} = \mathcal{U}$, we write (5.6) as

$$\mathbf{M}(\mathbf{B} \circ \mathbf{A}) = \mathbf{M}(\mathbf{B})\mathbf{M}(\mathbf{A}) \quad (5.7)$$

Matrices are determined entirely by their elements. For this reason a matrix \mathbf{A} whose elements are $\alpha_{11}, \alpha_{12}, \dots$ is sometimes denoted by (α_{ij}) . Similarly, the elements of this matrix are denoted by $(\mathbf{A})_{ij}$. So, on the one hand, we have $(\alpha_{ij}) = \mathbf{A}$, and on the other hand $(\mathbf{A})_{ij} = \alpha_{ij}$. In the context of this notation, therefore, we can write

$$(\mathbf{A} + \mathbf{B})_{ij} = (\mathbf{A})_{ij} + (\mathbf{B})_{ij} \Rightarrow (\alpha_{ij} + \beta_{ij}) = (\alpha_{ij}) + (\beta_{ij}),$$

$$(\gamma\mathbf{A})_{ij} = \gamma(\mathbf{A})_{ij} \Rightarrow \gamma(\alpha_{ij}) = (\gamma\alpha_{ij}),$$

$$(\mathbf{0})_{ij} = 0,$$

$$(\mathbf{1})_{ij} = \delta_{ij}.$$

A matrix, as a representation of a linear operator, is well-defined only in reference to a specific basis. A collection of rows and columns of numbers by themselves have no operational meaning. When we manipulate matrices and attach meaning to them, we make an unannounced assumption regarding the basis: We have the standard basis of \mathbb{C}^n (or \mathbb{R}^n) in mind. The following example should clarify this subtlety.

Example 5.1.5 Let us find the matrix representation of the linear operator $\mathbf{A} \in \mathcal{L}(\mathbb{R}^3)$, given by

$$\mathbf{A} \begin{pmatrix} x \\ y \\ z \end{pmatrix} = \begin{pmatrix} x - y + 2z \\ 3x - z \\ 2y + z \end{pmatrix} \quad (5.8)$$

in the basis

$$B = \left\{ |a_1\rangle = \begin{pmatrix} 1 \\ 1 \\ 0 \end{pmatrix}, |a_2\rangle = \begin{pmatrix} 1 \\ 0 \\ 1 \end{pmatrix}, |a_3\rangle = \begin{pmatrix} 0 \\ 1 \\ 1 \end{pmatrix} \right\}.$$

There is a tendency to associate the matrix

$$\begin{pmatrix} 1 & -1 & 2 \\ 3 & 0 & -1 \\ 0 & 2 & 1 \end{pmatrix}$$

with the operator \mathbf{A} . The following discussion will show that this is false.

To obtain the first column of the matrix representing \mathbf{A} , we note that

$$\begin{aligned} \mathbf{A}|a_1\rangle &= \mathbf{A} \begin{pmatrix} 1 \\ 1 \\ 0 \end{pmatrix} = \begin{pmatrix} 0 \\ 3 \\ 2 \end{pmatrix} = \frac{1}{2} \begin{pmatrix} 1 \\ 1 \\ 0 \end{pmatrix} - \frac{1}{2} \begin{pmatrix} 1 \\ 0 \\ 1 \end{pmatrix} + \frac{5}{2} \begin{pmatrix} 0 \\ 1 \\ 1 \end{pmatrix} \\ &= \frac{1}{2}|a_1\rangle - \frac{1}{2}|a_2\rangle + \frac{5}{2}|a_3\rangle. \end{aligned}$$

So, by Box 5.1.1, the first column of the matrix is

$$\begin{pmatrix} \frac{1}{2} \\ -\frac{1}{2} \\ \frac{5}{2} \end{pmatrix}.$$

The other two columns are obtained from

$$\begin{aligned} \mathbf{A}|a_2\rangle &= \mathbf{A} \begin{pmatrix} 1 \\ 0 \\ 1 \end{pmatrix} = \begin{pmatrix} 3 \\ 2 \\ 1 \end{pmatrix} = 2 \begin{pmatrix} 1 \\ 1 \\ 0 \end{pmatrix} + \begin{pmatrix} 1 \\ 0 \\ 1 \end{pmatrix} + 0 \begin{pmatrix} 0 \\ 1 \\ 1 \end{pmatrix}, \\ \mathbf{A}|a_3\rangle &= \mathbf{A} \begin{pmatrix} 0 \\ 1 \\ 1 \end{pmatrix} = \begin{pmatrix} 1 \\ -1 \\ 3 \end{pmatrix} = -\frac{3}{2} \begin{pmatrix} 1 \\ 1 \\ 0 \end{pmatrix} + \frac{5}{2} \begin{pmatrix} 1 \\ 0 \\ 1 \end{pmatrix} + \frac{1}{2} \begin{pmatrix} 0 \\ 1 \\ 1 \end{pmatrix}, \end{aligned}$$

giving the second and the third columns, respectively. The whole matrix is then

$$\mathbf{A} = \begin{pmatrix} \frac{1}{2} & 2 & -\frac{3}{2} \\ -\frac{1}{2} & 1 & \frac{5}{2} \\ \frac{5}{2} & 0 & \frac{1}{2} \end{pmatrix}.$$

As long as all vectors are represented by columns whose entries are expansion coefficients of the vectors in B , \mathbf{A} and \mathbf{A} are indistinguishable. However, the action of \mathbf{A} on the column vector $\begin{pmatrix} x \\ y \\ z \end{pmatrix}$ will not yield the RHS of Eq. (5.8)! Although this is not usually emphasized, the column vector on the LHS of Eq. (5.8) is really the vector

$$x \begin{pmatrix} 1 \\ 0 \\ 0 \end{pmatrix} + y \begin{pmatrix} 0 \\ 1 \\ 0 \end{pmatrix} + z \begin{pmatrix} 0 \\ 0 \\ 1 \end{pmatrix},$$

which is an expansion in terms of the *standard basis* of \mathbb{R}^3 rather than in terms of B .

We can expand $\mathbf{A} \begin{pmatrix} x \\ y \\ z \end{pmatrix}$ in terms of B , yielding

$$\begin{aligned} \mathbf{A} \begin{pmatrix} x \\ y \\ z \end{pmatrix} &= \begin{pmatrix} x - y + 2z \\ 3x - z \\ 2y + z \end{pmatrix} \\ &= \left(2x - \frac{3}{2}y\right) \begin{pmatrix} 1 \\ 1 \\ 0 \end{pmatrix} + \left(-x + \frac{1}{2}y + 2z\right) \begin{pmatrix} 1 \\ 0 \\ 1 \end{pmatrix} \\ &\quad + \left(x + \frac{3}{2}y - z\right) \begin{pmatrix} 0 \\ 1 \\ 1 \end{pmatrix}. \end{aligned}$$

This says that in the basis B this vector has the representation

$$\left(\mathbf{A} \begin{pmatrix} x \\ y \\ z \end{pmatrix} \right)_B = \begin{pmatrix} 2x - \frac{3}{2}y \\ -x + \frac{1}{2}y + 2z \\ x + \frac{3}{2}y - z \end{pmatrix}. \quad (5.9)$$

Similarly, $\begin{pmatrix} x \\ y \\ z \end{pmatrix}$ is represented by

$$\left(\begin{pmatrix} x \\ y \\ z \end{pmatrix} \right)_B = \begin{pmatrix} \frac{1}{2}x + \frac{1}{2}y - \frac{1}{2}z \\ \frac{1}{2}x - \frac{1}{2}y + \frac{1}{2}z \\ -\frac{1}{2}x + \frac{1}{2}y + \frac{1}{2}z \end{pmatrix}. \quad (5.10)$$

Applying \mathbf{A} to the RHS of (5.10) yields the RHS of (5.9), as it should.

5.2 Operations on Matrices

There are two basic operations that one can perform on a matrix to obtain a new one; these are transposition and complex conjugation. The **transpose** of a matrix

of an $M \times N$ matrix \mathbf{A} is an $N \times M$ matrix \mathbf{A}^t obtained by interchanging the rows and columns of \mathbf{A} :

$$(\mathbf{A}^t)_{ij} = (\mathbf{A})_{ji}, \quad \text{or} \quad (\alpha_{ij})^t = (\alpha_{ji}). \quad (5.11)$$

The following theorem, whose proof follows immediately from the definition of transpose, summarizes the important properties of the operation of transposition.

Theorem 5.2.1 *Let \mathbf{A} and \mathbf{B} be two matrices for which the operation of addition and/or multiplication are defined. Then*

- (a) $(\mathbf{A} + \mathbf{B})^t = \mathbf{A}^t + \mathbf{B}^t$,
- (b) $(\mathbf{AB})^t = \mathbf{B}^t \mathbf{A}^t$,
- (c) $(\mathbf{A}^t)^t = \mathbf{A}$.

Let $\mathbf{T} \in \mathcal{L}(\mathcal{V}, \mathcal{W})$ and $B_V = \{|a_i\rangle\}_{i=1}^N$ and $B_W = \{|b_j\rangle\}_{j=1}^M$ bases in \mathcal{V} and \mathcal{W} . Then

$$\mathbf{T}|a_i\rangle = \sum_{j=1}^M (\mathbf{T})_{ji} |b_j\rangle,$$

where $\mathbf{T} = \mathbf{M}_{B_V}^{B_W}(\mathbf{T})$. Let $\mathbf{T}^* \in \mathcal{L}(\mathcal{W}^*, \mathcal{V}^*)$ be the pull-back of \mathbf{T} and $B_V^* = \{\theta_k\}_{k=1}^N$ and $B_W^* = \{\phi_l\}_{l=1}^M$ bases dual to B_V and B_W . Then

$$\mathbf{T}^* \phi_l = \sum_{k=1}^N (\mathbf{T}^*)_{kl} \theta_k.$$

Apply both sides of this equation to $|a_i\rangle$ to get

$$\begin{aligned} \text{LHS} &= (\mathbf{T}^* \phi_l) |a_i\rangle \equiv \phi_l (\mathbf{T} |a_i\rangle) \\ &= \phi_l \left(\sum_{j=1}^M (\mathbf{T})_{ji} |b_j\rangle \right) = \sum_{j=1}^M (\mathbf{T})_{ji} \overbrace{\phi_l(|b_j\rangle)}^{=\delta_{lj}} = (\mathbf{T})_{li} \end{aligned}$$

and

$$\text{RHS} = \sum_{k=1}^N (\mathbf{T}^*)_{kl} \theta_k |a_i\rangle = \sum_{k=1}^N (\mathbf{T}^*)_{kl} \delta_{ki} = (\mathbf{T}^*)_{il}.$$

Comparing the last two equations, we have

Matrix of pullback of \mathbf{T} is transpose of matrix of \mathbf{T} .

Proposition 5.2.2 *Let $\mathbf{T} \in \mathcal{L}(\mathcal{V}, \mathcal{W})$ and B_V and B_W be bases in \mathcal{V} and \mathcal{W} . Let \mathbf{T}^* , B_V^* , and B_W^* be duals to \mathbf{T} , B_V , and B_W , respectively. Let $\mathbf{T} = \mathbf{M}_{B_V}^{B_W}(\mathbf{T})$ and $\mathbf{T}^* = \mathbf{M}_{B_W^*}^{B_V^*}(\mathbf{T}^*)$. Then $\mathbf{T}^* = \mathbf{T}^t$.*

Of special interest is a matrix that is equal to either its transpose or the negative of its transpose. Such matrices occur frequently in physics.

symmetric and
antisymmetric matrices

Definition 5.2.3 A matrix S is **symmetric** if $S^t = S$. Similarly, a matrix A is **antisymmetric** if $A^t = -A$.

Any matrix A can be written as $A = \frac{1}{2}(A + A^t) + \frac{1}{2}(A - A^t)$, where the first term is symmetric and the second is antisymmetric.

The elements of a symmetric matrix A satisfy the relation $\alpha_{ji} = (A^t)_{ij} = (A)_{ij} = \alpha_{ij}$; i.e., the matrix is symmetric under reflection through the main diagonal. On the other hand, for an antisymmetric matrix we have $\alpha_{ji} = -\alpha_{ij}$. In particular, the diagonal elements of an antisymmetric matrix are all zero.

orthogonal matrix
complex conjugation

A (real) matrix satisfying $A^t A = A A^t = 1$ is called **orthogonal**.

Complex conjugation is an operation under which all elements of a matrix are complex conjugated. Denoting the complex conjugate of A by A^* , we have $(A^*)_{ij} = (A)_{ij}^*$, or $(\alpha_{ij})^* = (\alpha_{ij}^*)$. A matrix is real if and only if $A^* = A$. Clearly, $(A^*)^* = A$.

hermitian conjugate

Under the combined operation of complex conjugation and transposition, the rows and columns of a matrix are interchanged and all of its elements are complex conjugated. This combined operation is called the **adjoint** operation, or **hermitian conjugation**, and is denoted by \dagger , as with operators. Thus, we have

$$\begin{aligned} A^\dagger &= (A^t)^* = (A^*)^t, \\ (A^\dagger)_{ij} &= (A)_{ji}^* \quad \text{or} \quad (\alpha_{ij})^\dagger = (\alpha_{ji}^*). \end{aligned} \tag{5.12}$$

Two types of matrices are important enough to warrant a separate definition.

hermitian and unitary
matrices

Definition 5.2.4 A **hermitian** matrix H satisfies $H^\dagger = H$, or, in terms of elements, $\eta_{ij}^* = \eta_{ji}$. A **unitary** matrix U satisfies $U^\dagger U = U U^\dagger = 1$, or, in terms of elements, $\sum_{k=1}^N \mu_{ik} \mu_{jk}^* = \sum_{k=1}^N \mu_{ki}^* \mu_{kj} = \delta_{ij}$.

Remarks It follows immediately from this definition that

1. The diagonal elements of a hermitian matrix are real.
2. The k th column of a hermitian matrix is the complex conjugate of its k th row, and vice versa.
3. A real hermitian matrix is symmetric.
4. The rows of an $N \times N$ unitary matrix, when considered as vectors in \mathbb{C}^N , form an orthonormal set, as do the columns.
5. A real unitary matrix is orthogonal.

It is sometimes possible (and desirable) to transform a matrix into a form in which all of its off-diagonal elements are zero. Such a matrix is called a **diagonal** matrix.

diagonal matrices

Box 5.2.5 A diagonal matrix whose diagonal elements are $\{\lambda_k\}_{k=1}^N$ is denoted by $\text{diag}(\lambda_1, \lambda_2, \dots, \lambda_N)$.

Example 5.2.6 In this example, we derive a useful identity for functions of a diagonal matrix. Let $D = \text{diag}(\lambda_1, \lambda_2, \dots, \lambda_n)$ be a diagonal matrix, and $f(x)$ a function that has a Taylor series expansion $f(x) = \sum_{k=0}^{\infty} a_k x^k$. The same function of D can be written as

$$\begin{aligned} f(D) &= \sum_{k=0}^{\infty} a_k D^k = \sum_{k=0}^{\infty} a_k [\text{diag}(\lambda_1, \lambda_2, \dots, \lambda_n)]^k \\ &= \sum_{k=0}^{\infty} a_k \text{diag}(\lambda_1^k, \lambda_2^k, \dots, \lambda_n^k) \\ &= \text{diag}\left(\sum_{k=0}^{\infty} a_k \lambda_1^k, \sum_{k=0}^{\infty} a_k \lambda_2^k, \dots, \sum_{k=0}^{\infty} a_k \lambda_n^k\right) \\ &= \text{diag}(f(\lambda_1), f(\lambda_2), \dots, f(\lambda_n)). \end{aligned}$$

In words, the function of a diagonal matrix is equal to a diagonal matrix whose entries are the same function of the corresponding entries of the original matrix. In the above derivation, we used the following obvious properties of diagonal matrices:

$$\begin{aligned} a \text{diag}(\lambda_1, \lambda_2, \dots, \lambda_n) &= \text{diag}(a\lambda_1, a\lambda_2, \dots, a\lambda_n), \\ \text{diag}(\lambda_1, \lambda_2, \dots, \lambda_n) + \text{diag}(\omega_1, \omega_2, \dots, \omega_n) \\ &= \text{diag}(\lambda_1 + \omega_1, \dots, \lambda_n + \omega_n), \\ \text{diag}(\lambda_1, \lambda_2, \dots, \lambda_n) \cdot \text{diag}(\omega_1, \omega_2, \dots, \omega_n) &= \text{diag}(\lambda_1\omega_1, \dots, \lambda_n\omega_n). \end{aligned}$$

Example 5.2.7 In this example, we list some familiar matrices in physics.

- (a) A prototypical symmetric matrix is that of the moment of inertia encountered in mechanics. The ij th element of this matrix is defined as $I_{ij} \equiv \iiint \rho(x_1, x_2, x_3) x_i x_j dV$, where x_i is the i th Cartesian coordinate of a point in the distribution of mass described by the volume density $\rho(x_1, x_2, x_3)$. It is clear that $I_{ij} = I_{ji}$, or $l = l^t$. The moment of inertia matrix can be represented as

$$l = \begin{pmatrix} I_{11} & I_{12} & I_{13} \\ I_{12} & I_{22} & I_{23} \\ I_{13} & I_{23} & I_{33} \end{pmatrix}.$$

It has six independent elements.

- (b) An example of an antisymmetric matrix is the electromagnetic field tensor given by

$$F = \begin{pmatrix} 0 & -B_3 & B_2 & E_1 \\ B_3 & 0 & -B_1 & E_2 \\ -B_2 & B_1 & 0 & E_3 \\ -E_1 & -E_2 & -E_3 & 0 \end{pmatrix}.$$

- (c) Examples of hermitian matrices are the 2×2 **Pauli spin matrices**:
- Pauli spin matrices
- $$\sigma_1 = \begin{pmatrix} 0 & 1 \\ 1 & 0 \end{pmatrix}, \quad \sigma_2 = \begin{pmatrix} 0 & -i \\ i & 0 \end{pmatrix}, \quad \sigma_3 = \begin{pmatrix} 1 & 0 \\ 0 & -1 \end{pmatrix}.$$
- (d) The most frequently encountered orthogonal matrices are rotations. One such matrix represents the rotation of a 3-dimensional rigid body in terms of **Euler angles** and is used in mechanics. Attaching a coordinate system to the body, a general rotation can be decomposed into a rotation of angle φ about the z -axis, followed by a rotation of angle θ about the *new* x -axis, followed by a rotation of angle ψ about the *new* z -axis. We simply exhibit this matrix in terms of these angles and leave it to the reader to show that it is indeed orthogonal.
- Euler angles
- $$\begin{pmatrix} \cos \psi \cos \varphi - \sin \psi \cos \theta \sin \varphi & -\cos \psi \sin \varphi - \sin \psi \cos \theta \cos \varphi & \sin \psi \sin \theta \\ \sin \psi \cos \varphi + \cos \psi \cos \theta \sin \varphi & -\sin \psi \sin \varphi + \cos \psi \cos \theta \cos \varphi & -\cos \psi \sin \theta \\ \sin \theta \sin \varphi & \sin \theta \cos \varphi & \cos \theta \end{pmatrix}.$$

5.3 Orthonormal Bases

The matrix representation of $\mathbf{A} \in \text{End}(\mathcal{V})$ is facilitated by choosing an *orthonormal* basis $B = \{|e_i\rangle\}_{i=1}^N$. The matrix elements of \mathbf{A} can be found in such a basis by “multiplying” both sides of $\mathbf{A}|e_i\rangle = \sum_{k=1}^N \alpha_{ki}|e_k\rangle$ on the left by $\langle e_j|$:

$$\langle e_j|\mathbf{A}|e_i\rangle = \langle e_j|\left(\sum_{k=1}^N \alpha_{ki}|e_k\rangle\right) = \sum_{k=1}^N \alpha_{ki} \underbrace{\langle e_j|e_k\rangle}_{=\delta_{jk}} = \alpha_{ji},$$

or

$$(\mathbf{A})_{ij} = \alpha_{ij} = \langle e_i|\mathbf{A}|e_j\rangle. \quad (5.13)$$

We can also show that in an orthonormal basis, the i th component ξ_i of a vector is found by multiplying the vector by $\langle e_i|$. This expression for ξ_i allows us to write the expansion of $|x\rangle$ as

$$|x\rangle = \sum_{j=1}^N \underbrace{\langle e_j|x\rangle}_{\xi_j} |e_j\rangle = \sum_{j=1}^N |e_j\rangle \langle e_j|x\rangle \Rightarrow \mathbf{1} = \sum_{j=1}^N |e_j\rangle \langle e_j|, \quad (5.14)$$

which is the same as in Proposition 4.4.6.

Let us now investigate the representation of the special operators discussed in Chap. 4 and find the connection between those operators and the matrices encountered in the last section. We begin by calculating the matrix representing the hermitian conjugate of an operator \mathbf{T} . In an orthonormal basis, the elements of this matrix are given by Eq. (5.13), $\tau_{ij} = \langle e_i|\mathbf{T}|e_j\rangle$. Taking the complex conjugate of this equation and using the definition of \mathbf{T}^\dagger given in Eq. (4.11), we obtain

$$\tau_{ij}^* = \langle e_i|\mathbf{T}|e_j\rangle^* = \langle e_j|\mathbf{T}^\dagger|e_i\rangle, \quad \text{or} \quad (\mathbf{T}^\dagger)_{ij} = \tau_{ji}^*.$$

This is precisely how the adjoint of a matrix was defined. Note how crucially this conclusion depends on the orthonormality of the basis vectors. If the basis were not orthonormal, we could not use Eq. (5.13) on which the conclusion is based. Therefore,

Box 5.3.1 *Only in an orthonormal basis is the adjoint of an operator represented by the adjoint of the matrix representing that operator.*

In particular, a hermitian operator is represented by a hermitian matrix only if an orthonormal basis is used. The following example illustrates this point.

Example 5.3.2 Consider the matrix representation of the hermitian operator \mathbf{H} in a general—not orthonormal—basis $B = \{|a_i\rangle\}_{i=1}^N$. The elements of the matrix corresponding to \mathbf{H} are given by

$$\mathbf{H}|a_k\rangle = \sum_{j=1}^N \eta_{jk}|a_j\rangle, \quad \text{or} \quad \mathbf{H}|a_i\rangle = \sum_{j=1}^N \eta_{ji}|a_j\rangle. \quad (5.15)$$

Taking the product of the first equation with $\langle a_i|$ and complex-conjugating the result gives

$$\langle a_i|\mathbf{H}|a_k\rangle^* = \left(\sum_{j=1}^N \eta_{jk}\langle a_i|a_j\rangle \right)^* = \sum_{j=1}^N \eta_{jk}^* \langle a_j|a_i\rangle.$$

But by the definition of a hermitian operator,

$$\langle a_i|\mathbf{H}|a_k\rangle^* = \langle a_k|\mathbf{H}^\dagger|a_i\rangle = \langle a_k|\mathbf{H}|a_i\rangle.$$

So we have $\langle a_k|\mathbf{H}|a_i\rangle = \sum_{j=1}^N \eta_{jk}^* \langle a_j|a_i\rangle$.

On the other hand, multiplying the second equation in (5.15) by $\langle a_k|$ gives

$$\langle a_k|\mathbf{H}|a_i\rangle = \sum_{j=1}^N \eta_{ji}\langle a_k|a_j\rangle.$$

The only conclusion we can draw from this discussion is

$$\sum_{j=1}^N \eta_{jk}^* \langle a_j|a_i\rangle = \sum_{j=1}^N \eta_{ji}\langle a_k|a_j\rangle.$$

Because this equation does not say anything about each individual η_{ij} , we cannot conclude, in general, that $\eta_{ij}^* = \eta_{ji}$. However, if the $|a_i\rangle$'s are orthonormal, then $\langle a_j|a_i\rangle = \delta_{ji}$ and $\langle a_k|a_j\rangle = \delta_{kj}$, and we obtain $\sum_{j=1}^N \eta_{jk}^* \delta_{ji} = \sum_{j=1}^N \eta_{ji} \delta_{kj}$, or $\eta_{ik}^* = \eta_{ki}$, as expected of a hermitian matrix.

Similarly, we expect the matrices representing unitary operators to be unitary only if the basis is orthonormal. This is an immediate consequence of Eq. (5.12), but we shall prove it in order to provide yet another example of how the completeness relation, Eq. (5.14), is used. Since $\mathbf{U}\mathbf{U}^\dagger = \mathbf{1}$, we have

$$\langle e_i | \mathbf{U}\mathbf{U}^\dagger | e_j \rangle = \langle e_i | \mathbf{1} | e_j \rangle = \langle e_i | e_j \rangle = \delta_{ij}.$$

We insert the completeness relation $\mathbf{1} = \sum_{k=1}^N |e_k\rangle\langle e_k|$ between \mathbf{U} and \mathbf{U}^\dagger on the LHS:

$$\langle e_i | \mathbf{U} \left(\sum_{k=1}^N |e_k\rangle\langle e_k| \right) \mathbf{U}^\dagger | e_j \rangle = \sum_{k=1}^N \underbrace{\langle e_i | \mathbf{U} | e_k \rangle}_{\equiv \mu_{ik}} \underbrace{\langle e_k | \mathbf{U}^\dagger | e_j \rangle}_{\equiv \mu_{jk}^*} = \delta_{ij}.$$

This equation gives the first half of the requirement for a unitary matrix given in Definition 5.2.4. By redoing the calculation for $\mathbf{U}^\dagger\mathbf{U}$, we could obtain the second half of that requirement.

5.4 Change of Basis

It is often advantageous to describe a physical problem in a particular basis because it takes a simpler form there, but the general form of the result may still be of importance. In such cases the problem is solved in one basis, and the result is transformed to other bases. Let us investigate this point in some detail.

Given a basis $B = \{|a_i\rangle\}_{i=1}^N$, we can write an arbitrary vector $|a\rangle$ with components $\{\alpha_i\}_{i=1}^N$ in B as $|a\rangle = \sum_{i=1}^N \alpha_i |a_i\rangle$. Now suppose that we change the basis to $B' = \{|a'_j\rangle\}_{j=1}^N$. How are the components of $|a\rangle$ in B' related to those in B ? To answer this question, we write $|a_i\rangle$ in terms of B' vectors,

$$|a_i\rangle = \sum_{j=1}^N \rho_{ji} |a'_j\rangle, \quad i = 1, 2, \dots, N,$$

which can also be abbreviated as

$$\begin{pmatrix} |a_1\rangle \\ |a_2\rangle \\ \vdots \\ |a_N\rangle \end{pmatrix} = \begin{pmatrix} \rho_{11} & \rho_{21} & \cdots & \rho_{N1} \\ \rho_{12} & \rho_{22} & \cdots & \rho_{N2} \\ \vdots & \vdots & & \vdots \\ \rho_{1N} & \rho_{2N} & \cdots & \rho_{NN} \end{pmatrix} \begin{pmatrix} |a'_1\rangle \\ |a'_2\rangle \\ \vdots \\ |a'_N\rangle \end{pmatrix}. \quad (5.16)$$

In this notation, we also have

$$|a\rangle = (\alpha_1 \quad \alpha_2 \quad \cdots \quad \alpha_N) \begin{pmatrix} |a_1\rangle \\ |a_2\rangle \\ \vdots \\ |a_N\rangle \end{pmatrix} \equiv \mathbf{a}^t \begin{pmatrix} |a_1\rangle \\ |a_2\rangle \\ \vdots \\ |a_N\rangle \end{pmatrix},$$

where \mathbf{a} is the column representation of $|a\rangle$ in B . Now multiply both sides of (5.16) by \mathbf{a}'^t to get

$$|a\rangle = \mathbf{a}'^t \begin{pmatrix} |a_1'\rangle \\ |a_2'\rangle \\ \vdots \\ |a_N'\rangle \end{pmatrix} \equiv \mathbf{a}'^t \mathbf{R}^t \begin{pmatrix} |a_1'\rangle \\ |a_2'\rangle \\ \vdots \\ |a_N'\rangle \end{pmatrix} \equiv \underbrace{(\alpha'_1 \quad \alpha'_2 \quad \dots \quad \alpha'_N)}_{\equiv \mathbf{a}'^t} \begin{pmatrix} |a_1'\rangle \\ |a_2'\rangle \\ \vdots \\ |a_N'\rangle \end{pmatrix}$$

where \mathbf{R} is the transpose of the $N \times N$ matrix of Eq. (5.16), and the last equality expresses $|a\rangle$ in B' . We therefore conclude that

$$\mathbf{a}'^t \equiv \mathbf{a}'^t \mathbf{R}^t,$$

where \mathbf{a}' designates a column vector with elements α'_j , the components of $|a\rangle$ in B' . Taking the transpose of the last equation yields

$$\mathbf{a}' = \mathbf{R}\mathbf{a} \quad \text{or} \quad \begin{pmatrix} \alpha'_1 \\ \alpha'_2 \\ \vdots \\ \alpha'_N \end{pmatrix} = \begin{pmatrix} \rho_{11} & \rho_{12} & \dots & \rho_{1N} \\ \rho_{21} & \rho_{22} & \dots & \rho_{2N} \\ \vdots & \vdots & & \vdots \\ \rho_{N1} & \rho_{N2} & \dots & \rho_{NN} \end{pmatrix} \begin{pmatrix} \alpha_1 \\ \alpha_2 \\ \vdots \\ \alpha_N \end{pmatrix}, \quad (5.17)$$

which in component form can be written as

$$\alpha'_j = \sum_{i=1}^N \rho_{ji} \alpha_i \quad \text{for } j = 1, 2, \dots, N. \quad (5.18)$$

The matrix \mathbf{R} is called the **basis transformation matrix**. It is invertible because it is a linear transformation that maps one basis onto another (see Proposition 4.1.3). basis transformation matrix

What happens to a matrix representation of an operator when we transform the basis? Consider the equation $|b\rangle = \mathbf{A}|a\rangle$, where $|a\rangle$ and $|b\rangle$ have components $\{\alpha_i\}_{i=1}^N$ and $\{\beta_i\}_{i=1}^N$, respectively, in B . This equation has a corresponding matrix equation $\mathbf{b} = \mathbf{A}\mathbf{a}$. Now, if we change the basis, the columns of the components of $|a\rangle$ and $|b\rangle$ will change to those of \mathbf{a}' and \mathbf{b}' , respectively. We seek a matrix \mathbf{A}' such that $\mathbf{b}' = \mathbf{A}'\mathbf{a}'$. This matrix will be the transform of \mathbf{A} . Using Eq. (5.17), we write $\mathbf{R}\mathbf{b} = \mathbf{A}'\mathbf{R}\mathbf{a}$, or $\mathbf{b} = \mathbf{R}^{-1}\mathbf{A}'\mathbf{R}\mathbf{a}$. Comparing this with $\mathbf{b} = \mathbf{A}\mathbf{a}$ and applying the fact that both equations hold for arbitrary \mathbf{a} and \mathbf{b} , we conclude that

$$\mathbf{R}^{-1}\mathbf{A}'\mathbf{R} = \mathbf{A}, \quad \text{or} \quad \mathbf{A}' = \mathbf{R}\mathbf{A}\mathbf{R}^{-1}. \quad (5.19)$$

This is called a **similarity transformation** on \mathbf{A} , and \mathbf{A}' is said to be **similar** to \mathbf{A} . similarity transformation

The transformation matrix \mathbf{R} can easily be found for orthonormal bases $B = \{|e_i\rangle\}_{i=1}^N$ and $B' = \{|e'_i\rangle\}_{i=1}^N$. We have $|e_i\rangle = \sum_{k=1}^N \rho_{ki} |e'_k\rangle$. Multiplying this equation by $\langle e'_j|$, we obtain

$$\langle e'_j | e_i \rangle = \sum_{k=1}^N \rho_{ki} \langle e'_j | e'_k \rangle = \sum_{k=1}^N \rho_{ki} \delta_{jk} = \rho_{ji}. \quad (5.20)$$

That is,

Box 5.4.1 To find the ij th element of the matrix that changes the components of a vector in the orthonormal basis B to those in the orthonormal basis B' , take the j th ket in B and multiply it by the i th bra in B' .

To find the ij th element of the matrix that changes B' into B , we take the j th ket in B' and multiply it by the i th bra in B : $\rho'_{ij} = \langle e_i | e'_j \rangle$. However, the matrix R' must be R^{-1} , as can be seen from Eq. (5.17). On the other hand, $(\rho'_{ij})^* = \langle e_i | e'_j \rangle^* = \langle e'_j | e_i \rangle = \rho_{ji}$, or

$$(R^{-1})_{ij}^* = \rho_{ji}, \quad \text{or} \quad (R^{-1})_{ij} = \rho_{ji}^* = (R^\dagger)_{ij}. \quad (5.21)$$

This shows that R is a unitary matrix and yields an important result.

Theorem 5.4.2 The matrix that transforms one orthonormal basis into another is necessarily unitary.

From Eqs. (5.20) and (5.21) we have $(R^\dagger)_{ij} = \langle e_i | e'_j \rangle$. Thus,

Box 5.4.3 To obtain the j th column of R^\dagger , we take the j th vector in the new basis and successively “multiply” it by $\langle e_i |$ for $i = 1, 2, \dots, N$.

In particular, if the original basis is the standard basis of \mathbb{C}^N and $|e'_j\rangle$ is represented by a column vector in that basis, then the j th column of R^\dagger is simply the vector $|e'_j\rangle$.

Example 5.4.4 In this example, we show that the similarity transform of a function of a matrix is the same function of the similarity transform of the matrix:

$$Rf(A)R^{-1} = f(RAR^{-1}).$$

The proof involves inserting $1 = R^{-1}R$ between factors of A in the Taylor series expansion of $f(A)$:

$$\begin{aligned} Rf(A)R^{-1} &= R \left(\sum_{k=0}^{\infty} a_k A^k \right) R^{-1} = \sum_{k=0}^{\infty} a_k R A^k R^{-1} = \sum_{k=0}^{\infty} a_k \overbrace{R A A \cdots A}^{k \text{ times}} R^{-1} \\ &= \sum_{k=0}^{\infty} a_k \overbrace{R A R^{-1} R A R^{-1} \cdots R A R^{-1}}^{k \text{ times}} = \sum_{k=0}^{\infty} a_k (R A R^{-1})^k \\ &= f(R A R^{-1}). \end{aligned}$$

This completes the proof.

5.5 Determinant of a Matrix

An important concept associated with linear operators is the determinant, which we have already discussed in Sect. 2.6.1. Determinants are also defined for matrices. If \mathbf{A} is representing \mathbf{A} in some basis, then we set $\det \mathbf{A} = \det \mathbf{A}$. That this relation is basis-independent is, of course, obvious from Definition 2.6.10 and the discussion preceding it. However, it can also be shown directly, as we shall do later in this chapter.

Let \mathbf{A} be a linear operator on \mathcal{V} . Let $\{|e_k\rangle\}_{k=1}^N$ be a basis of \mathcal{V} in which \mathbf{A} is represented by \mathbf{A} . Then the left-hand side of Eq. (2.32) becomes

$$\begin{aligned} \text{LHS} &= \Delta(\mathbf{A}|e_1\rangle, \dots, \mathbf{A}|e_N\rangle) = \Delta\left(\sum_{i_1=1}^N \alpha_{i_1 1} |e_{i_1}\rangle, \dots, \sum_{i_N=1}^N \alpha_{i_N N} |e_{i_N}\rangle\right) \\ &= \sum_{i_1 \dots i_N=1}^N \alpha_{i_1 1} \dots \alpha_{i_N N} \Delta(|e_{i_1}\rangle, \dots, |e_{i_N}\rangle) \\ &= \sum_{\pi} \alpha_{\pi(1)1} \dots \alpha_{\pi(N)N} \Delta(|e_{\pi(1)}\rangle, \dots, |e_{\pi(N)}\rangle) \\ &= \sum_{\pi} \alpha_{\pi(1)1} \dots \alpha_{\pi(N)N} \epsilon_{\pi} \cdot \Delta(|e_1\rangle, \dots, |e_N\rangle), \end{aligned}$$

where π is the permutation taking k to i_k . The right-hand side of Eq. (2.32) is just the product of $\det \mathbf{A}$ and $\Delta(|e_1\rangle, \dots, |e_N\rangle)$. Hence,

$$\det \mathbf{A} = \det \mathbf{A} = \sum_{\pi} \epsilon_{\pi} \alpha_{\pi(1)1} \dots \alpha_{\pi(N)N} \equiv \sum_{\pi} \epsilon_{\pi} \prod_{k=1}^N (\mathbf{A})_{\pi(k)k}. \quad (5.22)$$

Since $\pi(k) = i_k$, the product in the sum can be written as

$$\prod_{k=1}^N (\mathbf{A})_{i_k k} = \prod_{k=1}^N (\mathbf{A})_{i_k \pi^{-1}(i_k)} = \prod_{k=1}^N (\mathbf{A})_{k \pi^{-1}(k)} = \prod_{k=1}^N (\mathbf{A}^t)_{\pi^{-1}(k)k},$$

where the second equality follows because we can commute the numbers until $(\mathbf{A})_{1\pi^{-1}(1)}$ becomes the first term of the product, $(\mathbf{A})_{2\pi^{-1}(2)}$, the second term, and so on. Substituting this in (5.22) and noting that $\sum_{\pi} = \sum_{\pi^{-1}}$ and $\epsilon_{\pi^{-1}} = \epsilon_{\pi}$, we have

Theorem 5.5.1 *Let $\mathbf{A} \in \mathcal{L}(\mathcal{V})$ and \mathbf{A} its representation in any basis of \mathcal{V} . Then*

$$\begin{aligned} \det \mathbf{A} &= \det \mathbf{A} = \sum_{\pi} \epsilon_{\pi} \prod_{j=1}^N (\mathbf{A})_{\pi(j)j} = \sum_{i_1 \dots i_N} \epsilon_{i_1 i_2 \dots i_N} (\mathbf{A})_{i_1 1} \dots (\mathbf{A})_{i_N N} \\ \det \mathbf{A} &= \det \mathbf{A}^t = \sum_{\pi} \epsilon_{\pi} \prod_{j=1}^N (\mathbf{A})_{j\pi(j)} = \sum_{i_1 \dots i_N} \epsilon_{i_1 i_2 \dots i_N} (\mathbf{A})_{1i_1} \dots (\mathbf{A})_{Ni_N} \end{aligned}$$

where $\epsilon_{i_1 i_2 \dots i_N}$ is the symbol introduced in (2.29). In particular, $\det \mathbf{A}^t = \det \mathbf{A}$.

Let \mathbf{A} be any $N \times N$ matrix. Let $|v_j\rangle \in \mathbb{R}^N$ be the j th column of \mathbf{A} . Define the linear operator $\mathbf{A} \in \text{End}(\mathbb{R}^N)$ by

$$\mathbf{A}|e_j\rangle = |v_j\rangle, \quad j = 1, \dots, N, \quad (5.23)$$

where $\{|e_j\rangle\}_{j=1}^N$ is the standard basis of \mathbb{R}^N . Then \mathbf{A} is the matrix representing \mathbf{A} in the standard basis. Now let Δ be a determinant function in \mathbb{R}^N whose value is one at the standard basis. Then

$$\begin{aligned} \Delta(|v_1\rangle, \dots, |v_N\rangle) &= \Delta(\mathbf{A}|e_1\rangle, \dots, \mathbf{A}|e_N\rangle) \\ &= \det \mathbf{A} \cdot \Delta(|e_1\rangle, \dots, |e_N\rangle) = \det \mathbf{A} \end{aligned}$$

and, therefore,

$$\det \mathbf{A} = \Delta(|v_1\rangle, \dots, |v_N\rangle). \quad (5.24)$$

If instead of columns, we use rows $|u_j\rangle$, we obtain $\det \mathbf{A}^t = \Delta(|u_1\rangle, \dots, |u_N\rangle)$. Since Δ is a multilinear skew-symmetric function, and $\det \mathbf{A}^t = \det \mathbf{A}$, we have the following familiar theorem.

Theorem 5.5.2 *Let \mathbf{A} be a square matrix. Then*

1. $\det \mathbf{A}$ is linear with respect to any row or column vector of \mathbf{A} .
2. If any two rows or two columns of \mathbf{A} are interchanged, $\det \mathbf{A}$ changes sign.
3. Adding a multiple of one row (column) of \mathbf{A} to another row (column) of \mathbf{A} does not change $\det \mathbf{A}$.
4. $\det \mathbf{A} = 0$ iff the rows (columns) are linearly dependent.

5.5.1 Matrix of the Classical Adjoint

Since by Corollary 2.6.13, the classical adjoint of \mathbf{A} is essentially the inverse of \mathbf{A} , we expect its matrix representation to be essentially the inverse of the matrix of \mathbf{A} . To find this matrix, choose a basis $\{|e_j\rangle\}_{j=1}^N$ which evaluates the determinant function of Eq. (2.33) to 1. Then $\text{ad}(\mathbf{A})|e_i\rangle = c_{ji}|e_j\rangle$, with c_{ji} forming the representation matrix of $\text{ad}(\mathbf{A})$. Thus, substituting $|e_i\rangle$ for $|v\rangle$ on both sides of (2.33) and using the fact that $\{|e_j\rangle\}_{j=1}^N$ are linearly independent, we get

$$(-1)^{j-1} \Delta(|e_i\rangle, \mathbf{A}|e_1\rangle, \dots, \widehat{\mathbf{A}|e_j\rangle}, \dots, \mathbf{A}|e_N\rangle) = c_{ji}$$

or

$$\begin{aligned} c_{ji} &= (-1)^{j-1} \Delta\left(|e_i\rangle, \sum_{k_1=1}^N (\mathbf{A})_{k_1 1} |e_{k_1}\rangle, \dots, \widehat{\mathbf{A}|e_j\rangle}, \dots, \sum_{k_N=1}^N (\mathbf{A})_{k_N N} |e_{k_N}\rangle\right) \\ &= (-1)^{j-1} \sum_{k_1 \dots k_N} (\mathbf{A})_{k_1 1} \dots (\mathbf{A})_{k_N N} \Delta(|e_i\rangle, |e_{k_1}\rangle, \dots, |e_{k_N}\rangle) \\ &= (-1)^{j-1} \sum_{k_1 \dots k_N} (\mathbf{A})_{k_1 1} \dots (\mathbf{A})_{k_N N} \epsilon_{ik_1 \dots k_N}. \end{aligned}$$

The product in the sum does not include $(\mathbf{A})_{k_j j}$. This means that the entire j th column is missing in the product. Furthermore, because of the skew-symmetry of $\epsilon_{ik_1\dots k_N}$, none of the k_m 's can be i , and since k_m 's label the rows, the i th row is also absent in the sum. Now move i from the first location to the i th location. This will introduce a factor of $(-1)^{i-1}$ due to the $i - 1$ exchanges of indices. Inserting all this information in the previous equation, we obtain

$$c_{ji} = (-1)^{i+j} \sum_{k_1\dots k_N} (\mathbf{A})_{k_1 1} \dots (\mathbf{A})_{k_N N} \epsilon_{k_1\dots i\dots k_N}. \tag{5.25}$$

Now note that the sum is a determinant of an $(N - 1) \times (N - 1)$ matrix obtained from \mathbf{A} by eliminating its i th row and j th column. This determinant is called a **minor of order $N - 1$** and denoted by M_{ij} . The product $(-1)^{i+j} M_{ij}$ is called the **cofactor of $(\mathbf{A})_{ij}$** , and denoted by $(\text{cof } \mathbf{A})_{ij}$.

minor of order $N - 1$
cofactor of an element of
a matrix

With this and another obvious notation, (5.25) becomes

$$(\text{ad } \mathbf{A})_{ji} \equiv c_{ji} = (-1)^{i+j} M_{ij} = (\text{cof } \mathbf{A})_{ij}. \tag{5.26}$$

With the matrix of the adjoint at our disposal, we can write Eq. (2.34) in the matrix form. Doing so, and taking the ik th element of all sides, we get

$$\sum_{j=1}^N \text{ad}(\mathbf{A})_{ij} (\mathbf{A})_{jk} = \det \mathbf{A} \cdot \delta_{ik} = \sum_{j=1}^N (\mathbf{A})_{ij} \text{ad}(\mathbf{A})_{jk}.$$

Setting $k = i$ yields

$$\det \mathbf{A} = \sum_{j=1}^N \text{ad}(\mathbf{A})_{ij} (\mathbf{A})_{ji} = \sum_{j=1}^N (\mathbf{A})_{ij} \text{ad}(\mathbf{A})_{ji}$$

or, using (5.26),

$$\det \mathbf{A} = \sum_{j=1}^N (\mathbf{A})_{ji} (\text{cof } \mathbf{A})_{ji} = \sum_{j=1}^N (\mathbf{A})_{ij} (\text{cof } \mathbf{A})_{ij}. \tag{5.27}$$

This is the familiar expansion of a determinant by its i th column or i th row.

Historical Notes

Vandermonde, Alexandre-Thiéophile, also known as Alexis, Abnit, and Charles-Auguste Vandermonde (1735–1796) had a father, a physician who directed his sickly son toward a musical career. An acquaintanceship with Fontaine, however, so stimulated Vandermonde that in 1771 he was elected to the Académie des Sciences, to which he presented four mathematical papers (his total mathematical production) in 1771–1772. Later, Vandermonde wrote several papers on harmony, and it was said at that time that musicians considered Vandermonde to be a mathematician and that mathematicians viewed him as a musician.

Vandermonde’s membership in the Academy led to a paper on experiments with cold, made with Bezout and Lavoisier in 1776, and a paper on the manufacture of steel with Berthollet and Monge in 1786. Vandermonde became an ardent and active revolutionary, being such a close friend of Monge that he was termed “femme de Monge”. He was a member of the Commune of Paris and the club of the Jacobins. In 1782 he was director of

the Conservatoire des Arts et Métiers and in 1792, chief of the Bureau de l'Habillement des Armées. He joined in the design of a course in political economy for the École Normale and in 1795 was named a member of the Institut National.

Vandermonde is best known for the theory of determinants. Lebesgue believed that the attribution of determinant to Vandermonde was due to a misreading of his notation. Nevertheless, Vandermonde's fourth paper was the first to give a connected exposition of determinants, because he (1) defined a contemporary symbolism that was more complete, simple, and appropriate than that of Leibniz; (2) defined determinants as functions apart from the solution of linear equations presented by Cramer but also treated by Vandermonde; and (3) gave a number of properties of these functions, such as the number and signs of the terms and the effect of interchanging two consecutive indices (rows or columns), which he used to show that a determinant is zero if two rows or columns are identical.

Vandermonde's real and unrecognized claim to fame was lodged in his first paper, in which he approached the general problem of the solvability of algebraic equations through a study of functions invariant under permutations of the roots of the equations. Cauchy assigned priority in this to Lagrange and Vandermonde. Vandermonde read his paper in November 1770, but he did not become a member of the Academy until 1771, and the paper was not published until 1774. Although Vandermonde's methods were close to those later developed by Abel and Galois for testing the solvability of equations, and although his treatment of the binomial equation $x^n - 1 = 0$ could easily have led to the anticipation of Gauss's results on constructible polygons, Vandermonde himself did not rigorously or completely establish his results, nor did he see the implications for geometry. Nevertheless, Kronecker dates the modern movement in algebra to Vandermonde's 1770 paper.

Unfortunately, Vandermonde's spurt of enthusiasm and creativity, which in two years produced four insightful mathematical papers at least two of which were of substantial importance, was quickly diverted by the exciting politics of the time and perhaps by poor health.

Example 5.5.3 Let O and U denote, respectively, an orthogonal and a unitary $n \times n$ matrix; that is, $OO^t = O^tO = 1$, and $UU^\dagger = U^\dagger U = 1$. Taking the determinant of the first equation and using Theorems 2.6.11 (with $\lambda = 1$) and 5.5.1, we obtain

$$(\det O)(\det O^t) = (\det O)^2 = \det 1 = 1.$$

Therefore, for an orthogonal matrix, we get $\det O = \pm 1$.

Orthogonal transformations preserve a real inner product. Among such transformations are the so-called inversions, which, in their simplest form, multiply a vector by -1 . In three dimensions this corresponds to a reflection through the origin. The matrix associated with this operation is -1 :

$$\begin{pmatrix} x \\ y \\ z \end{pmatrix} \rightarrow \begin{pmatrix} -x \\ -y \\ -z \end{pmatrix} = \begin{pmatrix} -1 & 0 & 0 \\ 0 & -1 & 0 \\ 0 & 0 & -1 \end{pmatrix} \begin{pmatrix} x \\ y \\ z \end{pmatrix},$$

which has a determinant of -1 . This is a prototype of other, more complicated, orthogonal transformations whose determinants are -1 . The set of orthogonal matrices in n dimensions is denoted by $O(n)$.

The other orthogonal transformations, whose determinants are $+1$, are of special interest because they correspond to rotations in three dimensions. The set of orthogonal matrices in n dimensions having determinant $+1$ is denoted by $SO(n)$. These matrices are special because they have the mathematical structure of a (continuous) group, which finds application in many

areas of advanced physics. We shall come back to the topic of group theory later in the book.

We can obtain a similar result for unitary transformations. We take the determinant of both sides of $U^\dagger U = 1$:

$$\det(U^*)^t \det U = \det U^* \det U = (\det U)^* (\det U) = |\det U|^2 = 1.$$

Thus, we can generally write $\det U = e^{i\alpha}$, with $\alpha \in \mathbb{R}$. The set of unitary matrices in n dimensions is denoted by $U(n)$. The set of those matrices with $\alpha = 0$ forms a group to which 1 belongs and that is denoted by $SU(n)$. This group has found applications in the description of fundamental forces and the dynamics of fundamental particles.

5.5.2 Inverse of a Matrix

Equation (5.26) shows that the matrix of the classical adjoint is the transpose of the cofactor matrix. Using this, and writing (2.34) in matrix form yields

$$(\text{cof } A)^t A = \det A \cdot 1 = A(\text{cof } A)^t.$$

Therefore, we have

Theorem 5.5.4 *The matrix A has an inverse if and only if $\det A \neq 0$. Furthermore,* inverse of a matrix

$$A^{-1} = \frac{(\text{cof } A)^t}{\det A}. \quad (5.28)$$

This is the matrix form of the operator equation in Corollary 2.6.13.

Example 5.5.5 The inverse of a 2×2 matrix is easily found:

$$\begin{pmatrix} a & b \\ c & d \end{pmatrix}^{-1} = \frac{1}{ad - bc} \begin{pmatrix} d & -b \\ -c & a \end{pmatrix} \quad (5.29)$$

if $ad - bc \neq 0$.

We defined the determinant of an operator intrinsically, i.e., independent of a basis. We have also connected this intrinsic property to the determinant of the matrix representing that operator in some basis. We can now show directly that the matrices representing an operator in two arbitrary bases have the same determinant. We leave this as exercise for the reader in Problem 5.23.

Algorithm for Calculating the Inverse of a Matrix

There is a more practical way of calculating the inverse of matrices. In the following discussion of this method, we shall confine ourselves simply to stating a couple of definitions and the main theorem, with no attempt at providing any proofs. The practical utility of the method will be illustrated by a detailed analysis of examples.

elementary row operation **Definition 5.5.6** An **elementary row operation** on a matrix is one of the following:

- (a) interchange of two rows of the matrix,
- (b) multiplication of a row by a nonzero number, and
- (c) addition of a multiple of one row to another.

Elementary column operations are defined analogously.

triangular, or row-echelon form of a matrix **Definition 5.5.7** A matrix is in **triangular**, or row-echelon, form if it satisfies the following three conditions:

1. Any row consisting of only zeros is below any row that contains at least one nonzero element.
2. Going from left to right, the first nonzero entry of any row is to the left of the first nonzero entry of any lower row.
3. The first nonzero entry of each row is 1.

Theorem 5.5.8 For any invertible $n \times n$ matrix A , the $n \times 2n$ matrix $(A|1)$ can be transformed into the $n \times 2n$ matrix $(1|A^{-1})$ by means of a finite number of elementary row operations.¹

A systematic way of transforming $(A|1)$ into $(1|A^{-1})$ is first to bring A into triangular form and then eliminate all nonzero elements of each column by elementary row operations.

Example 5.5.9

Let us evaluate the inverse of

$$A = \begin{pmatrix} 1 & 2 & -1 \\ 0 & 1 & -2 \\ 2 & 1 & -1 \end{pmatrix}.$$

We start with

$$\left(\begin{array}{ccc|ccc} 1 & 2 & -1 & 1 & 0 & 0 \\ 0 & 1 & -2 & 0 & 1 & 0 \\ 2 & 1 & -1 & 0 & 0 & 1 \end{array} \right) \equiv M$$

and apply elementary row operations to M to bring the left half of it into triangular form. If we denote the k th row by (k) and the three operations of Definition 5.5.6, respectively, by $(k) \leftrightarrow (j)$, $\alpha(k)$, and $\alpha(k) + (j)$, we get

$$M \xrightarrow{-2(1)+(3)} \left(\begin{array}{ccc|ccc} 1 & 2 & -1 & 1 & 0 & 0 \\ 0 & 1 & -2 & 0 & 1 & 0 \\ 0 & -3 & 1 & -2 & 0 & 1 \end{array} \right)$$

¹The matrix $(A|1)$ denotes the $n \times 2n$ matrix obtained by juxtaposing the $n \times n$ unit matrix to the right of A . It can easily be shown that if A , B , and C are $n \times n$ matrices, then $A(B|C) = (AB|AC)$.

$$\begin{aligned} &\xrightarrow{3(2)+(3)} \left(\begin{array}{ccc|ccc} 1 & 2 & -1 & 1 & 0 & 0 \\ 0 & 1 & -2 & 0 & 1 & 0 \\ 0 & 0 & -5 & -2 & 3 & 1 \end{array} \right) \\ &\xrightarrow{-\frac{1}{5}(3)} \left(\begin{array}{ccc|ccc} 1 & 2 & -1 & 1 & 0 & 0 \\ 0 & 1 & -2 & 0 & 1 & 0 \\ 0 & 0 & 1 & 2/5 & -3/5 & -1/5 \end{array} \right) \equiv M'. \end{aligned}$$

The left half of M' is in triangular form. However, we want all entries above any 1 in a column to be zero as well, i.e., we want the left-hand matrix to be $\mathbf{1}$. We can do this by appropriate use of type 3 elementary row operations:

$$\begin{aligned} M' &\xrightarrow{-2(2)+(1)} \left(\begin{array}{ccc|ccc} 1 & 0 & 3 & 1 & -2 & 0 \\ 0 & 1 & -2 & 0 & 1 & 0 \\ 0 & 0 & 1 & 2/5 & -3/5 & -1/5 \end{array} \right) \\ &\xrightarrow{-3(3)+(1)} \left(\begin{array}{ccc|ccc} 1 & 0 & 0 & -1/5 & -1/5 & 3/5 \\ 0 & 1 & -2 & 0 & 1 & 0 \\ 0 & 0 & 1 & 2/5 & -3/5 & -1/5 \end{array} \right) \\ &\xrightarrow{2(3)+(2)} \left(\begin{array}{ccc|ccc} 1 & 0 & 0 & -1/5 & -1/5 & 3/5 \\ 0 & 1 & 0 & 4/5 & -1/5 & -2/5 \\ 0 & 0 & 1 & 2/5 & -3/5 & -1/5 \end{array} \right). \end{aligned}$$

The right half of the resulting matrix is \mathbf{A}^{-1} .

Example 5.5.10 It is instructive to start with a matrix that is not invertible and show that it is impossible to turn it into $\mathbf{1}$ by elementary row operations. Consider the matrix

$$\mathbf{B} = \begin{pmatrix} 2 & -1 & 3 \\ 1 & -2 & 1 \\ -1 & 5 & 0 \end{pmatrix}.$$

Let us systematically bring it into triangular form:

$$\begin{aligned} M &= \left(\begin{array}{ccc|ccc} 2 & -1 & 3 & 1 & 0 & 0 \\ 1 & -2 & 1 & 0 & 1 & 0 \\ -1 & 5 & 0 & 0 & 0 & 1 \end{array} \right) \xrightarrow{(1) \leftrightarrow (2)} \left(\begin{array}{ccc|ccc} 1 & -2 & 1 & 0 & 1 & 0 \\ 2 & -1 & 3 & 1 & 0 & 0 \\ -1 & 5 & 0 & 0 & 0 & 1 \end{array} \right) \\ &\xrightarrow{-2(1)+(2)} \left(\begin{array}{ccc|ccc} 1 & -2 & 1 & 0 & 1 & 0 \\ 0 & 3 & 1 & 1 & -2 & 0 \\ -1 & 5 & 0 & 0 & 0 & 1 \end{array} \right) \\ &\xrightarrow{(1)+(3)} \left(\begin{array}{ccc|ccc} 1 & -2 & 1 & 0 & 1 & 0 \\ 0 & 3 & 1 & 1 & -2 & 0 \\ 0 & 3 & 1 & 0 & 1 & 1 \end{array} \right) \end{aligned}$$

$$\begin{aligned} & \xrightarrow{-(2)+(3)} \left(\begin{array}{ccc|cc} 1 & -2 & 1 & 0 & 1 & 0 \\ 0 & 3 & 1 & 1 & -2 & 0 \\ 0 & 0 & 0 & -1 & 3 & 1 \end{array} \right) \\ & \xrightarrow{\frac{1}{3}(2)} \left(\begin{array}{ccc|cc} 1 & -2 & 1 & 0 & 1 & 0 \\ 0 & 1 & 1/3 & 1/3 & -2/3 & 0 \\ 0 & 0 & 0 & -1 & 3 & 1 \end{array} \right). \end{aligned}$$

The matrix \mathbf{B} is now in triangular form, but its third row contains all zeros. There is no way we can bring this into the form of a unit matrix. We therefore conclude that \mathbf{B} is not invertible. This is, of course, obvious, since it can easily be verified that \mathbf{B} has a vanishing determinant.

Rank of a Matrix

Given any $M \times N$ matrix \mathbf{A} , an operator $\mathbf{T}_A \in \mathcal{L}(\mathcal{V}_N, \mathcal{W}_M)$ can be associated with \mathbf{A} , and one can construct the kernel and the range of \mathbf{T}_A . The rank of \mathbf{T}_A is called the **rank of \mathbf{A}** . Since the rank of an operator is basis independent, this definition makes sense.

Now suppose that we choose a basis for the kernel of \mathbf{T}_A and extend it to a basis of \mathcal{V} . Let \mathcal{V}_1 denote the span of the remaining basis vectors. Similarly, we choose a basis for $\mathbf{T}_A(\mathcal{V})$ and extend it to a basis for \mathcal{W} . In these two bases, the $M \times N$ matrix representing \mathbf{T}_A will have all zeros except for an $r \times r$ submatrix, where r is the rank of \mathbf{T}_A . The reader may verify that this submatrix has a nonzero determinant. In fact, the submatrix represents the isomorphism between \mathcal{V}_1 and $\mathbf{T}_A(\mathcal{V})$, and, by its very construction, is the largest such matrix. Since the determinant of an operator is basis-independent, we have the following proposition.

Proposition 5.5.11 *The rank of a matrix is the dimension of the largest (square) submatrix whose determinant is not zero.*

5.5.3 Dual Determinant Function

Let \mathcal{V} and \mathcal{V}^* be N -dimensional dual vector spaces, and let $\Theta : \mathcal{V}^N \times \mathcal{V}^{*N} \rightarrow \mathbb{C}$ be a function defined by

$$\Theta(|v_1\rangle, \dots, |v_N\rangle, \phi_1, \dots, \phi_N) = \det(\phi_i(|v_j\rangle)), \quad \phi_i \in \mathcal{V}^*, |v_j\rangle \in \mathcal{V}. \quad (5.30)$$

By Theorem 5.5.2, Θ is a skew-symmetric linear function in $|v_1\rangle, \dots, |v_N\rangle$ as well as in ϕ_1, \dots, ϕ_N . Considering the first set of arguments and taking a nonzero determinant function Δ in \mathcal{V} , we can write

$$\Theta(|v_1\rangle, \dots, |v_N\rangle, \phi_1, \dots, \phi_N) = \Delta \cdot \underbrace{\Omega(\phi_1, \dots, \phi_N)}_{\in \mathbb{C}}$$

by Corollary 2.6.8. We note that Ω is a determinant function in \mathcal{V}^* . Thus, again by Corollary 2.6.8,

$$\Omega(\phi_1, \dots, \phi_N) = \beta \cdot \Delta^*(\phi_1, \dots, \phi_N),$$

for some nonzero determinant function Δ^* in \mathcal{V}^* and some $\beta \in \mathbb{C}$. Combining the last two equations, we obtain

$$\Theta(|v_1\rangle, \dots, |v_N\rangle, \phi_1, \dots, \phi_N) = \beta \Delta(|v_1\rangle, \dots, |v_N\rangle) \Delta^*(\phi_1, \dots, \phi_N). \quad (5.31)$$

Now let $\{\epsilon_i\}_{i=1}^N$ and $\{|e_j\rangle\}_{j=1}^N$ be dual bases. Then Eq. (5.30) gives

$$\Theta(|e_1\rangle, \dots, |e_N\rangle, \epsilon_1, \dots, \epsilon_N) = \det(\delta_{ij}) = 1,$$

and Eq. (5.31) yields

$$1 = \beta \Delta(|e_1\rangle, \dots, |e_N\rangle) \Delta^*(\epsilon_1, \dots, \epsilon_N).$$

This implies that $\beta \neq 0$. Multiplying both sides of (5.30) by $\alpha \equiv \beta^{-1}$ and using (5.31), we obtain

Proposition 5.5.12 *For any pair of nonzero determinant functions Δ and Δ^* in \mathcal{V} and \mathcal{V}^* , respectively, there is a nonzero constant $\alpha \in \mathbb{C}$ such that*

$$\Delta(|v_1\rangle, \dots, |v_N\rangle) \Delta^*(\phi_1, \dots, \phi_N) = \alpha \det(\phi_i(|v_j\rangle))$$

for $|v_j\rangle \in \mathcal{V}$ and $\phi_i \in \mathcal{V}^*$.

Definition 5.5.13 Two nonzero determinant function Δ and Δ^* in \mathcal{V} and \mathcal{V}^* , respectively, are called **dual** if

$$\Delta(|v_1\rangle, \dots, |v_N\rangle) \Delta^*(\phi_1, \dots, \phi_N) = \det(\phi_i(|v_j\rangle)).$$

dual determinant
functions

It is clear that if Δ and Δ^* are any two determinant functions, then Δ and $\alpha^{-1} \Delta^*$ are dual. Furthermore, if Δ_1^* and Δ_2^* are dual to Δ , then $\Delta_1^* = \Delta_2^*$, because they both satisfy the equation of Definition 5.5.13 and Δ is nonzero. We thus have

Proposition 5.5.14 *Every nonzero determinant function in \mathcal{V} has a unique dual determinant function.*

Here is another way of proving the equality of the determinants of a matrix and its transpose:

Proposition 5.5.15 *Let $\mathbf{T}^* \in \text{End}(\mathcal{V}^*)$ be the dual of $\mathbf{T} \in \text{End}(\mathcal{V})$. Then $\det \mathbf{T}^* = \det \mathbf{T}$. In particular, $\det \mathbf{T}^t = \det \mathbf{T}$.*

Proof Use Definition 5.5.13 to get

$$\Delta(|v_1\rangle, \dots, |v_N\rangle) \Delta^*(\mathbf{T}^* \phi_1, \dots, \mathbf{T}^* \phi_N) = \det(\mathbf{T}^* \phi_i(|v_j\rangle))$$

or

$$\det \mathbf{T}^* \cdot \Delta(|v_1\rangle, \dots, |v_N\rangle) \Delta^*(\phi_1, \dots, \phi_N) = \det(\mathbf{T}^* \phi_i(|v_j\rangle)).$$

Furthermore,

$$\Delta(\mathbf{T}|v_1, \dots, \mathbf{T}|v_N) \Delta^*(\phi_1, \dots, \phi_N) = \det(\phi_i(\mathbf{T}|v_j))$$

or

$$\det \mathbf{T} \cdot \Delta(|v_1\rangle, \dots, |v_N\rangle) \Delta^*(\phi_1, \dots, \phi_N) = \det(\phi_i(\mathbf{T}|v_j)).$$

Now noting that $\mathbf{T}^* \phi_i(|v_j\rangle) \equiv \phi_i(\mathbf{T}|v_j)$, we obtain the equality of the determinant of \mathbf{T} and \mathbf{T}^* , and by Proposition 5.2.2, the equality of the determinant of \mathbf{T} and \mathbf{T}^t . \square

5.6 The Trace

Another intrinsic quantity associated with an operator that is usually defined in terms of matrices is given in the following definition.

Definition 5.6.1 Let \mathbf{A} be an $N \times N$ matrix. The mapping $\text{tr} : \mathcal{M}^{N \times N} \rightarrow \mathbb{C}$ (or \mathbb{R}) given by $\text{tr} \mathbf{A} = \sum_{i=1}^N \alpha_{ii}$ is called the **trace** of \mathbf{A} .

Theorem 5.6.2 *The trace is a linear mapping. Furthermore,*

$$\text{tr}(\mathbf{AB}) = \text{tr}(\mathbf{BA}) \quad \text{and} \quad \text{tr} \mathbf{A}^t = \text{tr} \mathbf{A}.$$

Proof To prove the first identity, we use the definitions of the trace and the matrix product:

$$\begin{aligned} \text{tr}(\mathbf{AB}) &= \sum_{i=1}^N (\mathbf{AB})_{ii} = \sum_{i=1}^N \sum_{j=1}^N (\mathbf{A})_{ij} (\mathbf{B})_{ji} = \sum_{i=1}^N \sum_{j=1}^N (\mathbf{B})_{ji} (\mathbf{A})_{ij} \\ &= \sum_{j=1}^N \left(\sum_{i=1}^N (\mathbf{B})_{ji} (\mathbf{A})_{ij} \right) = \sum_{j=1}^N (\mathbf{BA})_{jj} = \text{tr}(\mathbf{BA}). \end{aligned}$$

The linearity of the trace and the second identity follow directly from the definition. \square

connection between
trace and determinant

Example 5.6.3 In this example, we show a very useful connection between the trace and the determinant that holds when a matrix is only infinitesimally different from the unit matrix. Let us calculate the determinant of $\mathbf{1} + \epsilon \mathbf{A}$ to first order in ϵ . Using the definition of determinant, we write

$$\begin{aligned} \det(\mathbf{1} + \epsilon \mathbf{A}) &= \sum_{i_1, \dots, i_n=1}^n \epsilon_{i_1 \dots i_n} (\delta_{1i_1} + \epsilon \alpha_{1i_1}) \dots (\delta_{ni_n} + \epsilon \alpha_{ni_n}) \\ &= \sum_{i_1, \dots, i_n=1}^n \epsilon_{i_1 \dots i_n} \delta_{1i_1} \dots \delta_{ni_n} \\ &\quad + \epsilon \sum_{k=1}^n \sum_{i_1, \dots, i_n=1}^n \epsilon_{i_1 \dots i_n} \delta_{1i_1} \dots \hat{\delta}_{ki_k} \dots \delta_{ni_n} \alpha_{ki_k}. \end{aligned}$$

The first sum is just the product of all the Kronecker deltas. In the second sum, $\hat{\delta}_{ki_k}$ means that in the product of the deltas, δ_{ki_k} is absent. This term is obtained by multiplying the second term of the k th parentheses by the first term of all the rest. Since we are interested only in the first power of ϵ , we stop at this term. Now, the first sum is reduced to $\epsilon_{12\dots n} = 1$ after all the Kronecker deltas are summed over. For the second sum, we get

$$\begin{aligned} & \epsilon \sum_{k=1}^n \sum_{i_1, \dots, i_n=1}^n \epsilon_{i_1 \dots i_n} \delta_{1i_1} \dots \hat{\delta}_{ki_k} \dots \delta_{ni_n} \alpha_{ki_k} \\ &= \epsilon \sum_{k=1}^n \sum_{i_k=1}^n \epsilon_{12\dots i_k \dots n} \alpha_{ki_k} \\ &= \epsilon \sum_{k=1}^n \epsilon_{12\dots k \dots n} \alpha_{kk} = \epsilon \sum_{k=1}^n \alpha_{kk} = \epsilon \operatorname{tr} \mathbf{A}, \end{aligned} \quad (5.32)$$

where the last line follows from the fact that the only nonzero value for $\epsilon_{12\dots i_k \dots n}$ is obtained when i_k is equal to the missing index, i.e., k , in which case it will be 1. Thus $\det(\mathbf{1} + \epsilon \mathbf{A}) = 1 + \epsilon \operatorname{tr} \mathbf{A}$.

Similar matrices have the same trace: If $\mathbf{A}' = \mathbf{R} \mathbf{A} \mathbf{R}^{-1}$, then

$$\begin{aligned} \operatorname{tr} \mathbf{A}' &= \operatorname{tr}(\mathbf{R} \mathbf{A} \mathbf{R}^{-1}) = \operatorname{tr}[\mathbf{R}(\mathbf{A} \mathbf{R}^{-1})] = \operatorname{tr}[(\mathbf{A} \mathbf{R}^{-1}) \mathbf{R}] \\ &= \operatorname{tr}[\mathbf{A}(\mathbf{R}^{-1} \mathbf{R})] = \operatorname{tr}(\mathbf{A} \mathbf{1}) = \operatorname{tr} \mathbf{A}. \end{aligned}$$

The preceding discussion is summarized in the following proposition.

Proposition 5.6.4 *To every operator $\mathbf{A} \in \mathcal{L}(\mathcal{V})$ are associated two intrinsic numbers, $\det \mathbf{A}$ and $\operatorname{tr} \mathbf{A}$, which are the determinant and trace of the matrix representation of the operator in any basis of \mathcal{V} .*

It follows from this proposition that the result of Example 5.6.3 can be written in terms of operators:

$$\det(\mathbf{1} + \epsilon \mathbf{A}) = 1 + \epsilon \operatorname{tr} \mathbf{A}. \quad (5.33)$$

A particularly useful formula that can be derived from this equation is the derivative at $t = 0$ of an operator $\mathbf{A}(t)$ depending on a single variable with the property that $\mathbf{A}(0) = \mathbf{1}$. To first order in t , we can write $\mathbf{A}(t) = \mathbf{1} + t \dot{\mathbf{A}}(0)$ where a dot represents differentiating with respect to t . Substituting this in Eq. (5.33) and differentiating with respect to t , we obtain the important result

$$\left. \frac{d}{dt} \det(\mathbf{A}(t)) \right|_{t=0} = \operatorname{tr} \dot{\mathbf{A}}(0). \quad (5.34)$$

Example 5.6.5 We have seen that the determinant of a *product* of matrices is the product of the determinants. On the other hand, the trace of a *sum* of matrices is the sum of traces. When dealing with numbers, products and

relation between
determinant and trace

sums are related via the logarithm and exponential: $\alpha\beta = \exp\{\ln\alpha + \ln\beta\}$. A generalization of this relation exists for diagonalizable matrices, i.e., matrices which can be transformed into diagonal form by a suitable similarity transformation. Let \mathbf{A} be such a matrix, i.e., let $\mathbf{D} = \mathbf{R}\mathbf{A}\mathbf{R}^{-1}$ for some similarity transformation \mathbf{R} and some diagonal matrix $\mathbf{D} = \text{diag}(\lambda_1, \lambda_2, \dots, \lambda_n)$. The determinant of a diagonal matrix is simply the product of its elements:

$$\det \mathbf{D} = \lambda_1 \lambda_2 \dots \lambda_n.$$

Taking the natural log of both sides and using the result of Example 5.2.6, we have

$$\ln(\det \mathbf{D}) = \ln \lambda_1 + \ln \lambda_2 + \dots + \ln \lambda_n = \text{tr}(\ln \mathbf{D}),$$

which can also be written as $\det \mathbf{D} = \exp\{\text{tr}(\ln \mathbf{D})\}$.

In terms of \mathbf{A} , this reads $\det(\mathbf{R}\mathbf{A}\mathbf{R}^{-1}) = \exp\{\text{tr}(\ln(\mathbf{R}\mathbf{A}\mathbf{R}^{-1}))\}$. Now invoke the invariance of determinant and trace under similarity transformation and the result of Example 5.4.4 to obtain

$$\det \mathbf{A} = \exp\{\text{tr}(\mathbf{R}(\ln \mathbf{A})\mathbf{R}^{-1})\} = \exp\{\text{tr}(\ln \mathbf{A})\}. \quad (5.35)$$

This is an important equation, which is sometimes used to define the determinant of operators in infinite-dimensional vector spaces.

Both the determinant and the trace are mappings from $\mathcal{M}^{N \times N}$ to \mathbb{C} . The determinant is not a linear mapping, but the trace is; and this opens up the possibility of defining an inner product in the vector space of $N \times N$ matrices in terms of the trace:

Proposition 5.6.6 *For any two matrices $\mathbf{A}, \mathbf{B} \in \mathcal{M}^{N \times N}$, the mapping*

$$g : \mathcal{M}^{N \times N} \times \mathcal{M}^{N \times N} \rightarrow \mathbb{C}$$

defined by $g(\mathbf{A}, \mathbf{B}) = \text{tr}(\mathbf{A}^\dagger \mathbf{B})$ is a sesquilinear inner product.

Proof The proof follows directly from the linearity of trace and the definition of hermitian conjugate. \square

Just as determinant of an operator was defined in terms of the operator itself (see Definition 2.6.10), the trace of an operator can be defined similarly as follows. Let Δ be a nonzero determinant function in \mathcal{V} , and $\mathbf{T} \in \mathcal{L}(\mathcal{V})$. Define $\text{tr } \mathbf{T}$ by

$$\sum_{i=1}^N \Delta(|a_1\rangle, \dots, \mathbf{T}|a_i\rangle, \dots, |a_N\rangle) = (\text{tr } \mathbf{T}) \cdot \Delta(|a_1\rangle, \dots, |a_N\rangle). \quad (5.36)$$

Then one can show that $\text{tr } \mathbf{T} = \text{tr } \mathbf{T}$, for any matrix \mathbf{T} representing \mathbf{T} in some basis of \mathcal{V} . The details are left as an exercise for the reader.

5.7 Problems

5.1 Show that if $|c\rangle = |a\rangle + |b\rangle$, then in any basis the components of $|c\rangle$ are equal to the sums of the corresponding components of $|a\rangle$ and $|b\rangle$. Also show that the elements of the matrix representing the sum of two operators are the sums of the elements of the matrices representing those two operators.

5.2 Show that the unit operator $\mathbf{1}$ is represented by the unit matrix in any basis.

5.3 The linear operator $\mathbf{A} : \mathbb{R}^3 \rightarrow \mathbb{R}^2$ is given by

$$\mathbf{A} \begin{pmatrix} x \\ y \\ z \end{pmatrix} = \begin{pmatrix} 2x + y - 3z \\ x + y - z \end{pmatrix}.$$

Construct the matrix representing \mathbf{A} in the standard bases of \mathbb{R}^3 and \mathbb{R}^2 .

5.4 Find the matrix representation of the complex structure \mathbf{J} on a real vector space \mathcal{V} introduced in Sect. 2.4 in the basis

$$\{|e_1\rangle, |e_2\rangle, \dots, |e_m\rangle, \mathbf{J}|e_1\rangle, \mathbf{J}|e_2\rangle, \dots, \mathbf{J}|e_m\rangle\}.$$

5.5 The linear transformation $\mathbf{T} : \mathbb{R}^3 \rightarrow \mathbb{R}^3$ is defined as

$$\mathbf{T}(x_1, x_2, x_3) = (x_1 + x_2 - x_3, 2x_1 - x_3, x_1 + 2x_2).$$

Find the matrix representation of \mathbf{T} in

- the standard basis of \mathbb{R}^3 ,
- the basis consisting of $|a_1\rangle = (1, 1, 0)$, $|a_2\rangle = (1, 0, -1)$, and $|a_3\rangle = (0, 2, 3)$.

5.6 Prove that for Eq. (5.6) to hold, we must have

$$(\mathbf{M}_{B_V}^{B_U}(\mathbf{B} \circ \mathbf{A}))_{kj} = \sum_{i=1}^M (\mathbf{M}_{B_W}^{B_U}(\mathbf{B}))_{ki} (\mathbf{M}_{B_V}^{B_W}(\mathbf{A}))_{ij}$$

5.7 Show that the diagonal elements of an antisymmetric matrix are all zero.

5.8 Show that the number of independent *real* parameters for an $N \times N$

- (real) symmetric matrix is $N(N + 1)/2$,
- (real) antisymmetric matrix is $N(N - 1)/2$,
- (real) orthogonal matrix is $N(N - 1)/2$,
- (complex) unitary matrix is N^2 ,
- (complex) hermitian matrix is N^2 .

5.9 Show that an arbitrary orthogonal 2×2 matrix can be written in one of the following two forms:

$$\begin{pmatrix} \cos \theta & -\sin \theta \\ \sin \theta & \cos \theta \end{pmatrix} \quad \text{or} \quad \begin{pmatrix} \cos \theta & \sin \theta \\ \sin \theta & -\cos \theta \end{pmatrix}.$$

The first is a pure rotation (its determinant is $+1$), and the second has determinant -1 . The form of the choices is dictated by the assumption that the first entry of the matrix reduces to 1 when $\theta = 0$.

5.10 Derive the formulas

$$\cos(\theta_1 + \theta_2) = \cos \theta_1 \cos \theta_2 - \sin \theta_1 \sin \theta_2,$$

$$\sin(\theta_1 + \theta_2) = \sin \theta_1 \cos \theta_2 + \cos \theta_1 \sin \theta_2$$

by noting that the rotation of the angle $\theta_1 + \theta_2$ in the xy -plane is the product of two rotations. (See Problem 5.9.)

5.11 Prove that if a matrix M satisfies $MM^\dagger = 0$, then $M = 0$. Note that in general, $M^2 = 0$ does not imply that M is zero. Find a nonzero 2×2 matrix whose square is zero.

5.12 Construct the matrix representations of

$$\mathbf{D}: \mathcal{P}_4^c[t] \rightarrow \mathcal{P}_4^c[t] \quad \text{and} \quad \mathbf{T}: \mathcal{P}_3^c[t] \rightarrow \mathcal{P}_4^c[t],$$

the derivative and multiplication-by- t operators. Choose $\{1, t, t^2, t^3\}$ as your basis of $\mathcal{P}_3^c[t]$ and $\{1, t, t^2, t^3, t^4\}$ as your basis of $\mathcal{P}_4^c[t]$. Use the matrix of \mathbf{D} so obtained to find the first, second, third, fourth, and fifth derivatives of a general polynomial of degree 4.

5.13 Find the transformation matrix R that relates the (orthonormal) standard basis of \mathbb{C}^3 to the orthonormal basis obtained from the following vectors via the Gram-Schmidt process:

$$|a_1\rangle = \begin{pmatrix} 1 \\ i \\ 0 \end{pmatrix}, \quad |a_2\rangle = \begin{pmatrix} 0 \\ 1 \\ -i \end{pmatrix}, \quad |a_3\rangle = \begin{pmatrix} i \\ 0 \\ -1 \end{pmatrix}.$$

Verify that R is unitary, as expected from Theorem 5.4.2.

5.14 If the matrix representation of an endomorphism \mathbf{T} of \mathbb{C}^2 with respect to the standard basis is $\begin{pmatrix} 1 & 1 \\ 1 & 1 \end{pmatrix}$, what is its matrix representation with respect to the basis $\left\{ \begin{pmatrix} 1 \\ 1 \end{pmatrix}, \begin{pmatrix} 1 \\ -1 \end{pmatrix} \right\}$?

5.15 If the matrix representation of an endomorphism \mathbf{T} of \mathbb{C}^3 with respect to the standard basis is

$$\begin{pmatrix} 0 & 1 & 1 \\ 1 & 0 & -1 \\ -1 & -1 & 0 \end{pmatrix}$$

what is the representation of \mathbf{T} with respect to the basis

$$\left\{ \begin{pmatrix} 0 \\ 1 \\ -1 \end{pmatrix}, \begin{pmatrix} 1 \\ -1 \\ 1 \end{pmatrix}, \begin{pmatrix} -1 \\ 1 \\ 0 \end{pmatrix} \right\}?$$

5.16 Using Theorem 5.5.1, calculate the determinant of a general 3×3 matrix and obtain the familiar expansion of such a determinant in terms of the first row of the matrix.

5.17 Using Theorem 5.5.1, show that if two rows (two columns) of a matrix are equal, then its determinant is zero.

5.18 Show that $\det(\alpha A) = \alpha^N \det A$ for an $N \times N$ matrix A and a complex number α .

5.19 Show that $\det \mathbf{1} = 1$ for any unit matrix.

5.20 Find a specific pair of matrices A and B such that $\det(A + B) \neq \det A + \det B$. Therefore, the determinant is *not* a linear mapping. Hint: *Any* pair of matrices will most likely work. In fact, the challenge is to find a pair such that $\det(A + B) = \det A + \det B$.

5.21 Let A be any $N \times N$ matrix. Replace its i th row (column) with any one of its other rows (columns), leaving the latter unchanged. Now expand the determinant of the new matrix by its i th row (column) to show that

$$\sum_{j=1}^N (A)_{ji} (\text{cof } A)_{jk} = \sum_{j=1}^N (A)_{ij} (\text{cof } A)_{kj} = 0, \quad k \neq i.$$

5.22 Demonstrate the result of Problem 5.21 using an arbitrary 4×4 matrix and evaluating the sum explicitly.

5.23 Suppose that \mathbf{A} is represented by A in one basis and by A' in another, related to the first by a similarity transformation R . Show directly that $\det A' = \det A$.

5.24 Show explicitly that $\det(AB) = \det A \det B$ for 2×2 matrices.

5.25 Given three $N \times N$ matrices A , B , and C such that $AB = C$ with C invertible, show that both A and B must be invertible. Thus, any two operators \mathbf{A} and \mathbf{B} on a *finite*-dimensional vector space satisfying $\mathbf{AB} = \mathbf{1}$ are invertible and each is the inverse of the other. Note: This is not true for infinite-dimensional vector spaces.

5.26 Show directly that the similarity transformation induced by R does not change the determinant or the trace of A where

$$R = \begin{pmatrix} 1 & 2 & -1 \\ 0 & 1 & -2 \\ 2 & 1 & -1 \end{pmatrix} \quad \text{and} \quad A = \begin{pmatrix} 3 & -1 & 2 \\ 0 & 1 & -2 \\ 1 & -3 & -1 \end{pmatrix}.$$

5.27 Find the matrix that transforms the standard basis of \mathbb{C}^3 to the vectors

$$|a_1\rangle = \begin{pmatrix} \frac{1}{\sqrt{2}} \\ \frac{1}{\sqrt{6}} \\ \frac{1+i}{\sqrt{6}} \end{pmatrix}, \quad |a_2\rangle = \begin{pmatrix} \frac{-i}{\sqrt{2}} \\ \frac{i}{\sqrt{6}} \\ \frac{-1+i}{\sqrt{6}} \end{pmatrix}, \quad |a_3\rangle = \begin{pmatrix} 0 \\ \frac{-2}{\sqrt{6}} \\ \frac{1+i}{\sqrt{6}} \end{pmatrix}.$$

Show that this matrix is unitary.

5.28 Consider the three operators \mathbf{L}_1 , \mathbf{L}_2 , and \mathbf{L}_3 satisfying

$$[\mathbf{L}_1, \mathbf{L}_2] = i\mathbf{L}_3, \quad [\mathbf{L}_3, \mathbf{L}_1] = i\mathbf{L}_2, \quad [\mathbf{L}_2, \mathbf{L}_3] = i\mathbf{L}_1.$$

Show that the trace of each of these operators is necessarily zero.

5.29 Show that in the expansion of the determinant given in Theorem 5.5.1, no two elements of the same row or the same column can appear in each term of the sum.

5.30 Find the inverse of the following matrices if they exist:

$$A = \begin{pmatrix} 3 & -1 & 2 \\ 1 & 0 & -3 \\ -2 & 1 & -1 \end{pmatrix}, \quad B = \begin{pmatrix} 0 & 1 & -1 \\ 1 & 2 & 0 \\ -1 & -2 & 1 \end{pmatrix},$$

$$C = \begin{pmatrix} 1 & 0 & 1 \\ 0 & 1 & 0 \\ 1 & 0 & -1 \end{pmatrix}.$$

5.31 Find inverses for the following matrices using both methods discussed in this chapter.

$$A = \begin{pmatrix} 2 & 1 & -1 \\ 2 & 1 & 2 \\ -1 & -2 & -2 \end{pmatrix}, \quad B = \begin{pmatrix} 1 & 2 & -1 \\ 0 & 1 & -2 \\ 2 & 1 & -1 \end{pmatrix},$$

$$C = \begin{pmatrix} 1 & -1 & 1 \\ -1 & 1 & 1 \\ 1 & -1 & -2 \end{pmatrix},$$

$$D = \begin{pmatrix} 1/\sqrt{2} & 0 & (1-i)/(2\sqrt{2}) & (1+i)/(2\sqrt{2}) \\ 0 & 1/\sqrt{2} & (1-i)/(2\sqrt{2}) & -(1+i)/(2\sqrt{2}) \\ 1/\sqrt{2} & 0 & -(1-i)/(2\sqrt{2}) & -(1+i)/(2\sqrt{2}) \\ 0 & 1/\sqrt{2} & -(1-i)/(2\sqrt{2}) & (1+i)/(2\sqrt{2}) \end{pmatrix}.$$

5.32 Let \mathbf{A} be an operator on \mathcal{V} . Show that if $\det \mathbf{A} = 0$, then there exists a nonzero vector $|x\rangle \in \mathcal{V}$ such that $\mathbf{A}|x\rangle = 0$.

5.33 For which values of α are the following matrices invertible? Find the inverses whenever they exist.

$$\mathbf{A} = \begin{pmatrix} 1 & \alpha & 0 \\ \alpha & 1 & \alpha \\ 0 & \alpha & 1 \end{pmatrix}, \quad \mathbf{B} = \begin{pmatrix} \alpha & 1 & 0 \\ 1 & \alpha & 1 \\ 0 & 1 & \alpha \end{pmatrix},$$

$$\mathbf{C} = \begin{pmatrix} 0 & 1 & \alpha \\ 1 & \alpha & 0 \\ \alpha & 0 & 1 \end{pmatrix}, \quad \mathbf{D} = \begin{pmatrix} 1 & 1 & 1 \\ 1 & 1 & \alpha \\ 1 & \alpha & 1 \end{pmatrix}.$$

5.34 Let $\{\mathbf{a}_i\}_{i=1}^N$ be the set consisting of the N rows of an $N \times N$ matrix \mathbf{A} and assume that the \mathbf{a}_i are orthogonal to each other. Show that

$$|\det \mathbf{A}| = \|\mathbf{a}_1\| \|\mathbf{a}_2\| \cdots \|\mathbf{a}_N\|.$$

Hint: Consider $\mathbf{A}\mathbf{A}^\dagger$. What would the result be if \mathbf{A} were a unitary matrix?

5.35 Prove that a set of n homogeneous linear equations in n unknowns has a nontrivial solution if and only if the determinant of the matrix of coefficients is zero.

5.36 Use determinants to show that an antisymmetric matrix whose dimension is odd cannot have an inverse.

5.37 Let \mathcal{V} be a real inner product space. Let $\Theta : \mathcal{V}^N \times \mathcal{V}^N \rightarrow \mathbb{R}$ be a function defined by

$$\Theta(|v_1\rangle, \dots, |v_N\rangle, |u_1\rangle, \dots, |u_N\rangle) = \det(\langle u_i | v_j \rangle).$$

Follow the same procedure as in Sect. 5.5.3 to show that for any determinant function Δ in \mathcal{V} there is a nonzero constant $\alpha \in \mathbb{R}$ such that

$$\Delta(|v_1\rangle, \dots, |v_N\rangle)\Delta(|u_1\rangle, \dots, |u_N\rangle) = \alpha \det(\langle u_i | v_j \rangle)$$

for $|u_i\rangle, |v_j\rangle \in \mathcal{V}$.

5.38 Show that $\text{tr}(|a\rangle\langle b|) = \langle b|a\rangle$. Hint: Evaluate the trace in an orthonormal basis.

5.39 Show that if two invertible $N \times N$ matrices \mathbf{A} and \mathbf{B} anticommute (that is, $\mathbf{A}\mathbf{B} + \mathbf{B}\mathbf{A} = 0$), then (a) N must be even, and (b) $\text{tr} \mathbf{A} = \text{tr} \mathbf{B} = 0$.

5.40 Show that for a spatial rotation $R_{\hat{n}}(\theta)$ of an angle θ about an arbitrary axis \hat{n} , $\text{tr} R_{\hat{n}}(\theta) = 1 + 2 \cos \theta$.

5.41 Express the sum of the squares of elements of a matrix as a trace. Show that this sum is invariant under an orthogonal transformation of the matrix.

5.42 Let S and A be a symmetric and an antisymmetric matrix, respectively, and let M be a general matrix. Show that

- (a) $\text{tr } M = \text{tr } M^t$,
- (b) $\text{tr}(SA) = 0$; in particular, $\text{tr } A = 0$,
- (c) SA is antisymmetric if and only if $[S, A] = 0$,
- (d) MSM^t is symmetric and MAM^t is antisymmetric,
- (e) MHM^\dagger is hermitian if H is.

5.43 Find the trace of each of the following linear operators:

- (a) $\mathbf{T}: \mathbb{R}^3 \rightarrow \mathbb{R}^3$ given by

$$\mathbf{T}(x, y, z) = (x + y - z, 2x + 3y - 2z, x - y).$$

- (b) $\mathbf{T}: \mathbb{R}^3 \rightarrow \mathbb{R}^3$ given by

$$\mathbf{T}(x, y, z) = (y - z, x + 2y + z, z - y).$$

- (c) $\mathbf{T}: \mathbb{C}^4 \rightarrow \mathbb{C}^4$ given by

$$\mathbf{T}(x, y, z, w) = (x + iy - z + iw, 2ix + 3y - 2iz - w, x - iy, z + iw).$$

5.44 Use Eq. (5.35) to derive Eq. (5.33).

5.45 Suppose that there are two operators \mathbf{A} and \mathbf{B} such that $[\mathbf{A}, \mathbf{B}] = c\mathbf{1}$, where c is a constant. Show that the vector space in which such operators are defined cannot be finite-dimensional. Conclude that the position and momentum operators of quantum mechanics can be defined only in infinite dimensions.

5.46 Use Eq. (5.36) to show that $\text{tr } \mathbf{T} = \text{tr } T$, for any matrix T representing \mathbf{T} in some basis of \mathcal{V} .

The last chapter discussed matrix representation of operators. It was pointed out there that such a representation is basis-dependent. In some bases, the operator may “look” quite complicated, while in others it may take a simple form. In a “special” basis, the operator may look the simplest: It may be a diagonal matrix. This chapter investigates conditions under which a basis exists in which the operator is represented by a diagonal matrix.

6.1 Invariant Subspaces

We start by recalling the notion of the direct sum of more than two subspaces and assume that

$$\mathcal{V} = \mathcal{U}_1 \oplus \mathcal{U}_2 \oplus \cdots \oplus \mathcal{U}_r \equiv \bigoplus_{j=1}^r \mathcal{U}_j. \tag{6.1}$$

Then by Proposition 4.4.1, there exist idempotents $\{\mathbf{P}_j\}_{j=1}^r$ such that

$$\mathbf{P}_i \mathbf{P}_j = \delta_{ij} \mathbf{P}_i \text{ (no sum)} \quad \text{and} \quad \sum_{j=1}^r \mathbf{P}_j = \mathbf{1}. \tag{6.2}$$

Definition 6.1.1 Let \mathcal{V} be an inner product space. Let \mathcal{M} be any subspace of \mathcal{V} . Denote by \mathcal{M}^\perp the set of all vectors in \mathcal{V} orthogonal to all the vectors in \mathcal{M} . \mathcal{M}^\perp (pronounced “em perp”) is called the **orthogonal complement** of \mathcal{M} .

orthogonal complement
of a subspace

Proposition 6.1.2 \mathcal{M}^\perp is a subspace of \mathcal{V} .

Proof The straightforward proof is left as an exercise for the reader. □

If \mathcal{V} of Eq. (6.1) is an *inner product* space, and the subspaces are mutually orthogonal, then for arbitrary $|u\rangle, |v\rangle \in \mathcal{V}$,

when projection
operators become
hermitian

$$\langle u | \mathbf{P}_j | v \rangle = \langle u | v_j \rangle = \langle u_j | v_j \rangle = \langle v_j | u_j \rangle^* = \langle v | u_j \rangle^* = \langle v | \mathbf{P}_j | u \rangle^*$$

which shows that \mathbf{P}_j is hermitian.

Consider an orthonormal basis $B_M = \{|e_i\rangle\}_{i=1}^m$ for \mathcal{M} , and extend it to a basis $B = \{|e_i\rangle\}_{i=1}^N$ for \mathcal{V} . Now construct a (hermitian) projection operator $\mathbf{P} = \sum_{i=1}^m |e_i\rangle\langle e_i|$. This is the operator that projects an arbitrary vector in \mathcal{V} onto the subspace \mathcal{M} . It is straightforward to show that $\mathbf{1} - \mathbf{P}$ is the projection operator that projects onto \mathcal{M}^\perp (see Problem 6.1).

An arbitrary vector $|a\rangle \in \mathcal{V}$ can be written as

$$|a\rangle = (\mathbf{P} + \mathbf{1} - \mathbf{P})|a\rangle = \underbrace{\mathbf{P}|a\rangle}_{\text{in } \mathcal{M}} + \underbrace{(\mathbf{1} - \mathbf{P})|a\rangle}_{\text{in } \mathcal{M}^\perp}.$$

Furthermore, the only vector that can be in both \mathcal{M} and \mathcal{M}^\perp is the zero vector, because it is the only vector orthogonal to itself. We thus have

Proposition 6.1.3 *If \mathcal{V} is an inner product space, then $\mathcal{V} = \mathcal{M} \oplus \mathcal{M}^\perp$ for any subspace \mathcal{M} . Furthermore, the projection operators corresponding to \mathcal{M} and \mathcal{M}^\perp are hermitian.*

This section explores the possibility of obtaining subspaces by means of the action of a linear operator on vectors of an N -dimensional vector space \mathcal{V} . Let $|a\rangle$ be any vector in \mathcal{V} , and \mathbf{A} a linear operator on \mathcal{V} . The vectors

$$|a\rangle, \mathbf{A}|a\rangle, \mathbf{A}^2|a\rangle, \dots, \mathbf{A}^N|a\rangle$$

are linearly dependent (there are $N + 1$ of them). Let $\mathcal{M} \equiv \text{Span}\{\mathbf{A}^k|a\rangle\}_{k=0}^N$. It follows that, $m \equiv \dim \mathcal{M} \leq \dim \mathcal{V}$, and \mathcal{M} has the property that for any vector $|x\rangle \in \mathcal{M}$ the vector $\mathbf{A}|x\rangle$ also belongs to \mathcal{M} (show this!). In other words, no vector in \mathcal{M} “leaves” the subspace when acted on by \mathbf{A} .

invariant subspace;
reduction of an operator

Definition 6.1.4 A subspace \mathcal{M} is an **invariant subspace** of the operator \mathbf{A} if \mathbf{A} transforms vectors of \mathcal{M} into vectors of \mathcal{M} . This is written succinctly as $\mathbf{A}(\mathcal{M}) \subset \mathcal{M}$. We say that \mathcal{M} **reduces** \mathbf{A} if both \mathcal{M} and \mathcal{M}^\perp are invariant subspaces of \mathbf{A} .

Starting with a basis of \mathcal{M} , we can extend it to a basis $B = \{|a_i\rangle\}_{i=1}^N$ of \mathcal{V} whose first m vectors span \mathcal{M} . The matrix representation of \mathbf{A} in such a basis is given by the relation $\mathbf{A}|a_i\rangle = \sum_{j=1}^N \alpha_{ji} |a_j\rangle$, $i = 1, 2, \dots, N$. If $i \leq m$, then $\alpha_{ji} = 0$ for $j > m$, because $\mathbf{A}|a_i\rangle$ belongs to \mathcal{M} when $i \leq m$ and therefore can be written as a linear combination of only $\{|a_1\rangle, |a_2\rangle, \dots, |a_m\rangle\}$. Thus, the matrix representation of \mathbf{A} in B will have the form

$$\mathbf{A} = \begin{pmatrix} \mathbf{A}_{11} & \mathbf{A}_{12} \\ \mathbf{0}_{21} & \mathbf{A}_{22} \end{pmatrix},$$

matrix representation of
an operator in a
subspace

where \mathbf{A}_{11} is an $m \times m$ matrix, \mathbf{A}_{12} an $m \times (N - m)$ matrix, $\mathbf{0}_{21}$ the $(N - m) \times m$ zero matrix, and \mathbf{A}_{22} an $(N - m) \times (N - m)$ matrix. We say that \mathbf{A}_{11} **represents** the operator \mathbf{A} in the m -dimensional subspace \mathcal{M} .

It may also happen that the subspace spanned by the remaining basis vectors in B , namely $|a_{m+1}\rangle, |a_{m+2}\rangle, \dots, |a_N\rangle$, is also an invariant subspace

of \mathbf{A} . Then A_{12} will be zero, and \mathbf{A} will take a **block diagonal** form:¹

$$\mathbf{A} = \begin{pmatrix} A_{11} & 0 \\ 0 & A_{22} \end{pmatrix}.$$

block diagonal matrix defined

If a matrix representing an operator can be brought into this form by a suitable choice of basis, it is called **reducible**; otherwise, it is called **irreducible**. A reducible matrix \mathbf{A} is denoted in two different ways:²

reducible and irreducible matrices

$$\mathbf{A} = \begin{pmatrix} A_1 & 0 \\ 0 & A_2 \end{pmatrix} \Leftrightarrow \mathbf{A} = A_1 \oplus A_2. \tag{6.3}$$

For example, when \mathcal{M} reduces \mathbf{A} and one chooses a basis the first m vectors of which are in \mathcal{M} and the remaining ones in \mathcal{M}^\perp , then \mathbf{A} is reducible.

We have seen on a number of occasions the significance of the hermitian conjugate of an operator (e.g., in relation to hermitian and unitary operators). The importance of this operator will be borne out further when we study the spectral theorem later in this chapter. Let us now investigate some properties of the adjoint of an operator in the context of invariant subspaces.

Lemma 6.1.5 *A subspace \mathcal{M} of an inner product space \mathcal{V} is invariant under the linear operator \mathbf{A} if and only if \mathcal{M}^\perp is invariant under \mathbf{A}^\dagger .*

condition for invariance

Proof The proof is left as a problem. □

An immediate consequence of the above lemma and the two identities $(\mathbf{A}^\dagger)^\dagger = \mathbf{A}$ and $(\mathcal{M}^\perp)^\perp = \mathcal{M}$ is contained in the following theorem.

Theorem 6.1.6 *A subspace of \mathcal{V} reduces \mathbf{A} if and only if it is invariant under both \mathbf{A} and \mathbf{A}^\dagger .*

Lemma 6.1.7 *Let \mathcal{M} be a subspace of \mathcal{V} and \mathbf{P} the hermitian projection operator onto \mathcal{M} . Then \mathcal{M} is invariant under the linear operator \mathbf{A} if and only if $\mathbf{AP} = \mathbf{PAP}$.*

Proof Suppose \mathcal{M} is invariant. Then for any $|x\rangle$ in \mathcal{V} , we have

$$\mathbf{P}|x\rangle \in \mathcal{M} \Rightarrow \mathbf{AP}|x\rangle \in \mathcal{M} \Rightarrow \mathbf{PAP}|x\rangle = \mathbf{AP}|x\rangle.$$

Since the last equality holds for arbitrary $|x\rangle$, we have $\mathbf{AP} = \mathbf{PAP}$.

Conversely, suppose $\mathbf{AP} = \mathbf{PAP}$. For any $|y\rangle \in \mathcal{M}$, we have

$$\mathbf{P}|y\rangle = |y\rangle \Rightarrow \underbrace{\mathbf{AP}}_{=\mathbf{PAP}}|y\rangle = \mathbf{A}|y\rangle = \mathbf{P}(\mathbf{AP}|y\rangle) \in \mathcal{M}.$$

Therefore, \mathcal{M} is invariant under \mathbf{A} . □

¹From now on, we shall denote all zero matrices by the same symbol regardless of their dimensionality.

²It is common to use a single subscript for submatrices of a block diagonal matrix, just as it is common to use a single subscript for entries of a diagonal matrix.

Theorem 6.1.8 Let \mathcal{M} be a subspace of \mathcal{V} , \mathbf{P} the hermitian projection operator of \mathcal{V} onto \mathcal{M} , and \mathbf{A} a linear operator on \mathcal{V} . Then \mathcal{M} reduces \mathbf{A} if and only if \mathbf{A} and \mathbf{P} commute.

Proof Suppose \mathcal{M} reduces \mathbf{A} . Then by Theorem 6.1.6, \mathcal{M} is invariant under both \mathbf{A} and \mathbf{A}^\dagger . Lemma 6.1.7 then implies

$$\mathbf{A}\mathbf{P} = \mathbf{P}\mathbf{A}\mathbf{P} \quad \text{and} \quad \mathbf{A}^\dagger\mathbf{P} = \mathbf{P}\mathbf{A}^\dagger\mathbf{P}. \quad (6.4)$$

Taking the adjoint of the second equation yields $(\mathbf{A}^\dagger\mathbf{P})^\dagger = (\mathbf{P}\mathbf{A}^\dagger\mathbf{P})^\dagger$, or $\mathbf{P}\mathbf{A} = \mathbf{P}\mathbf{A}\mathbf{P}$. This equation together with the first equation of (6.4) yields $\mathbf{P}\mathbf{A} = \mathbf{A}\mathbf{P}$.

Conversely, suppose that $\mathbf{P}\mathbf{A} = \mathbf{A}\mathbf{P}$. Then $\mathbf{P}^2\mathbf{A} = \mathbf{P}\mathbf{A}\mathbf{P}$, whence $\mathbf{P}\mathbf{A} = \mathbf{P}\mathbf{A}\mathbf{P}$. Taking adjoints gives $\mathbf{A}^\dagger\mathbf{P} = \mathbf{P}\mathbf{A}^\dagger\mathbf{P}$, because \mathbf{P} is hermitian. By Lemma 6.1.7, \mathcal{M} is invariant under \mathbf{A}^\dagger . Similarly, from $\mathbf{P}\mathbf{A} = \mathbf{A}\mathbf{P}$, we get $\mathbf{P}\mathbf{A}\mathbf{P} = \mathbf{A}\mathbf{P}^2$, whence $\mathbf{P}\mathbf{A}\mathbf{P} = \mathbf{A}\mathbf{P}$. Once again by Lemma 6.1.7, \mathcal{M} is invariant under \mathbf{A} . By Theorem 6.1.6, \mathcal{M} reduces \mathbf{A} . \square

6.2 Eigenvalues and Eigenvectors

The main goal of the remaining part of this chapter is to prove that certain kinds of operators, for example a hermitian operator, is diagonalizable, that is, that we can always find an (orthonormal) basis in which it is represented by a diagonal matrix.

Let us begin by considering eigenvalues and eigenvectors, which are generalizations of familiar concepts in two and three dimensions. Consider the operation of rotation about the z -axis by an angle θ denoted by $\mathbf{R}_z(\theta)$. Such a rotation takes any vector (x, y) in the xy -plane to a new vector $(x \cos \theta - y \sin \theta, x \sin \theta + y \cos \theta)$. Thus, unless $(x, y) = (0, 0)$ or θ is an integer multiple of 2π , the vector will change. Is there a nonzero vector that is so special (*eigen*, in German) that it does not change when acted on by $\mathbf{R}_z(\theta)$? As long as we confine ourselves to two dimensions, the answer is no. But if we lift ourselves up from the two-dimensional xy -plane, we encounter many such vectors, all of which lie along the z -axis.

The foregoing example can be generalized to any rotation (normally specified by Euler angles). In fact, the methods developed in this section can be used to show that a general rotation, given by Euler angles, always has an unchanged vector lying along the axis around which the rotation takes place. This concept is further generalized in the following definition.

Definition 6.2.1 Let $\mathbf{A} \in \text{End}(\mathcal{V})$ be a linear transformation, and $|a\rangle$ a nonzero vector such that

eigenvector and
eigenvalue

$$\mathbf{A}|a\rangle = \lambda|a\rangle, \quad (6.5)$$

with $\lambda \in \mathbb{C}$. We then say that $|a\rangle$ is an **eigenvector** of \mathbf{A} with **eigenvalue** λ .

Proposition 6.2.2 Add the zero vector to the set of all eigenvectors of \mathbf{A} belonging to the same eigenvalue λ , and denote the span of the resulting set by \mathcal{M}_λ . Then \mathcal{M}_λ is a subspace of \mathcal{V} , and every (nonzero) vector in \mathcal{M}_λ is an eigenvector of \mathbf{A} with eigenvalue λ .

Proof The proof follows immediately from the above definition and the definition of a subspace. \square

Definition 6.2.3 The subspace \mathcal{M}_λ is referred to as the **eigenspace** of \mathbf{A} corresponding to the eigenvalue λ . Its dimension is called the **geometric multiplicity** of λ . An eigenvalue is called **simple** if its geometric multiplicity is 1. The set of eigenvalues of \mathbf{A} is called the **spectrum** of \mathbf{A} .

By their very construction, eigenspaces corresponding to different eigenvalues have no vectors in common except the zero vector. This can be demonstrated by noting that if $|v\rangle \in \mathcal{M}_\lambda \cap \mathcal{M}_\mu$ for $\lambda \neq \mu$, then

$$0 = (\mathbf{A} - \lambda\mathbf{1})|v\rangle = \mathbf{A}|v\rangle - \lambda|v\rangle = \mu|v\rangle - \lambda|v\rangle = \underbrace{(\mu - \lambda)}_{\neq 0}|v\rangle \Rightarrow |v\rangle = 0.$$

An immediate consequence of this fact is

$$\mathcal{M}_\lambda + \mathcal{M}_\mu = \mathcal{M}_\lambda \oplus \mathcal{M}_\mu$$

if $\lambda \neq \mu$.

More generally,

Proposition 6.2.4 If $\{\lambda_i\}_{i=1}^r$ are distinct eigenvalues of an operator \mathbf{A} and \mathcal{M}_i is the eigenspace corresponding to λ_i , then

$$\mathcal{M}_1 + \cdots + \mathcal{M}_r = \mathcal{M}_1 \oplus \cdots \oplus \mathcal{M}_r \equiv \bigoplus_{i=1}^r \mathcal{M}_i. \quad (6.6)$$

In particular, by Proposition 2.1.15, the eigenvectors of \mathbf{A} corresponding to distinct eigenvalues are linearly independent.

Let us rewrite Eq. (6.5) as $(\mathbf{A} - \lambda\mathbf{1})|a\rangle = 0$. This equation says that $|a\rangle$ is an eigenvector of \mathbf{A} if and only if $|a\rangle$ belongs to the kernel of $\mathbf{A} - \lambda\mathbf{1}$. If the latter is invertible, then its kernel will consist of only the zero vector, which is not acceptable as a solution of Eq. (6.5). Thus, if we are to obtain nontrivial solutions, $\mathbf{A} - \lambda\mathbf{1}$ must have no inverse. This is true if and only if

$$\det(\mathbf{A} - \lambda\mathbf{1}) = 0. \quad (6.7)$$

The determinant in Eq. (6.7) is a polynomial in λ , called the **characteristic polynomial** of \mathbf{A} . The roots of this polynomial are called **characteristic roots** and are simply the eigenvalues of \mathbf{A} . Now, any polynomial of degree greater than or equal to 1 has at least one (complex) root. This yields the following theorem.

eigenspace
spectrum

characteristic
polynomial and
characteristic roots of an
operator

Theorem 6.2.5 Every operator on a finite-dimensional vector space over \mathbb{C} has at least one eigenvalue and therefore at least one eigenvector.

Let $\lambda_1, \lambda_2, \dots, \lambda_p$ be the distinct roots of the characteristic polynomial of \mathbf{A} , and let λ_j occur m_j times. Then m_j is called the **algebraic multiplicity** of λ_j , and

$$\det(\mathbf{A} - \lambda \mathbf{1}) = (\lambda_1 - \lambda)^{m_1} \cdots (\lambda_p - \lambda)^{m_p} = \prod_{j=1}^p (\lambda_j - \lambda)^{m_j}. \quad (6.8)$$

For $\lambda = 0$, this gives

$$\det \mathbf{A} = \lambda_1^{m_1} \lambda_2^{m_2} \cdots \lambda_p^{m_p} = \prod_{j=1}^p \lambda_j^{m_j}. \quad (6.9)$$

determinant and eigenvalues Equation (6.9) states that the determinant of an operator is the product of all its eigenvalues. In particular,

Proposition 6.2.6 An operator is invertible iff none of its eigenvalues is zero.

eigenvalues of a projection operator **Example 6.2.7** Let us find the eigenvalues of a projection operator \mathbf{P} . If $|a\rangle$ is an eigenvector, then $\mathbf{P}|a\rangle = \lambda|a\rangle$. Applying \mathbf{P} on both sides again, we obtain

$$\mathbf{P}^2|a\rangle = \lambda\mathbf{P}|a\rangle = \lambda(\lambda|a\rangle) = \lambda^2|a\rangle.$$

But $\mathbf{P}^2 = \mathbf{P}$; thus, $\mathbf{P}|a\rangle = \lambda^2|a\rangle$. It follows that $\lambda^2|a\rangle = \lambda|a\rangle$, or $(\lambda^2 - \lambda)|a\rangle = 0$. Since $|a\rangle \neq 0$, we must have $\lambda(\lambda - 1) = 0$, or $\lambda = 0, 1$. Thus, the only eigenvalues of a projection operator are 0 and 1. The presence of zero as an eigenvalue of \mathbf{P} is an indication that \mathbf{P} is not invertible.

Example 6.2.8 To be able to see the difference between algebraic and geometric multiplicities, consider the matrix $\mathbf{A} = \begin{pmatrix} 1 & 1 \\ 0 & 1 \end{pmatrix}$, whose characteristic polynomial is $(1 - \lambda)^2$. Thus, the matrix has only one eigenvalue, $\lambda = 1$, with algebraic multiplicity $m_1 = 2$. However, the most general vector $|a\rangle$ satisfying $(\mathbf{A} - \mathbf{1})|a\rangle = 0$ is easily shown to be of the form $\begin{pmatrix} \alpha \\ 0 \end{pmatrix}$. This shows that $\mathcal{M}_{\lambda=1}$ is one-dimensional, i.e., the geometric multiplicity of λ is 1.

As mentioned at the beginning of this chapter, it is useful to represent an operator by a diagonal matrix. This motivates the following definition:

diagonalizable operators **Definition 6.2.9** A linear operator \mathbf{A} on a vector space \mathcal{V} is said to be **diagonalizable** if there is a basis for \mathcal{V} all of whose vectors are eigenvectors of \mathbf{A} .

Theorem 6.2.10 Let \mathbf{A} be a diagonalizable operator on a vector space \mathcal{V} with distinct eigenvalues $\{\lambda_j\}_{j=1}^r$. Then there are idempotents \mathbf{P}_j on \mathcal{V} such that

$$(1) \quad \mathbf{1} = \sum_{j=1}^r \mathbf{P}_j, \quad (2) \quad \mathbf{P}_i \mathbf{P}_j = 0 \quad \text{for } i \neq j, \quad (3) \quad \mathbf{A} = \sum_{j=1}^r \lambda_j \mathbf{P}_j.$$

Proof Let \mathcal{M}_j denote the eigenspace corresponding to the eigenvalue λ_j . Since the eigenvectors span \mathcal{V} , by Proposition 6.2.4 we have

$$\mathcal{V} = \mathcal{M}_1 \oplus \mathcal{M}_2 \oplus \cdots \oplus \mathcal{M}_r.$$

This immediately gives (1) and (2) if we use Eqs. (6.1) and (6.2) where \mathbf{P}_j is the projection operator onto \mathcal{M}_j .

To prove (3), let $|v\rangle$ be an arbitrary vector in \mathcal{V} . Then $|v\rangle$ can be written uniquely as a sum of vectors each coming from one eigenspace. Therefore,

$$\mathbf{A}|v\rangle = \sum_{j=1}^r \mathbf{A}|v_j\rangle = \sum_{j=1}^r \lambda_j |v_j\rangle = \left(\sum_{j=1}^r \lambda_j \mathbf{P}_j \right) |v\rangle.$$

Since this equality holds for all vectors $|v\rangle$, (3) follows. \square

6.3 Upper-Triangular Representations

Let $\mathbf{T} \in \text{End}(\mathcal{V})$ and $\{|a_i\rangle\}_{i=1}^N$ a basis of \mathcal{V} . Suppose that $\text{Span}\{|a_i\rangle\}_{i=1}^m$ is invariant under \mathbf{T} for $m = 1, \dots, N$, i.e.,

$$\mathbf{T}(\text{Span}\{|a_i\rangle\}_{i=1}^m) \subseteq \text{Span}\{|a_i\rangle\}_{i=1}^m \quad \text{for each } m = 1, 2, \dots, N. \quad (6.10)$$

Consider the $N \times N$ matrix representing \mathbf{T} in this basis. Since $\mathbf{T}|a_1\rangle \in \text{Span}\{|a_1\rangle\}$, all the elements of the first column of this matrix except possibly the first are zero. Since $\mathbf{T}|a_2\rangle \in \text{Span}\{|a_1\rangle, |a_2\rangle\}$, all the elements of the second column except possibly the first two are zero. And in general all the elements of the i th column except possibly the first i elements are zero. Thus the matrix representing \mathbf{T} is upper-triangular. upper-triangular
representation

Expanding the determinant of the upper-triangular matrix above by its first column and continuing the same process for the cofactors, we see that $\det \mathbf{T}$ is simply the product of the elements on the main diagonal. Furthermore, $\mathbf{T} - \lambda \mathbf{1}$ is also an upper-triangular matrix whose diagonal elements are of the form $\lambda_i - \lambda$, where λ_i are the diagonal elements of \mathbf{T} . Hence,

$$\det(\mathbf{T} - \lambda \mathbf{1}) = (\lambda_1 - \lambda) \cdots (\lambda_N - \lambda),$$

and we have the following:

Proposition 6.3.1 The operator \mathbf{T} is invertible iff its upper-triangular matrix representation has no zero on its main diagonal. The entries on the main diagonal are simply the eigenvalues of \mathbf{T} .

As the foregoing discussion shows, upper-triangular representations of an operator seem to be convenient. But do they exist? In other words, can we find a basis of \mathcal{V} in which an operator \mathbf{T} is represented by an upper-triangular matrix? For the case of a complex vector space the answer is ‘yes,’ as the following theorem demonstrates.

Theorem 6.3.2 *Let \mathcal{V} be a complex vector space of dimension N and $\mathbf{T} \in \text{End}(\mathcal{V})$. Then there exists a basis of \mathcal{V} in which \mathbf{T} is represented by an upper-triangular matrix.*

Proof We prove the theorem by induction on the dimension of subspaces of \mathcal{V} . For a one-dimensional subspace \mathcal{U} , Theorem 6.2.5 guarantees the existence of a vector $|u\rangle$ —the eigenvector of \mathbf{T} —for which Eq. (6.10) holds. Let $\mathcal{U} = \text{Span}\{|u\rangle\}$ and write

$$\mathcal{V} = \mathcal{U} \oplus \mathcal{W},$$

which is possible by Proposition 2.1.16. Let \mathbf{T}_U and \mathbf{T}_W be as in Eq. (4.13). Since $\mathbf{T}_W \in \text{End}(\mathcal{W})$ and $\dim \mathcal{W} = N - 1$, we can use the induction hypothesis on \mathbf{T}_W and assume that there exists a basis $B_W = \{|a_i\rangle\}_{i=1}^{N-1}$ of \mathcal{W} , such that

$$\mathbf{T}_W |a_i\rangle \in \text{Span}\{|a_1\rangle, |a_2\rangle, \dots, |a_i\rangle\} \quad \text{for each } i = 1, 2, \dots, N - 1.$$

Now consider the basis $B_V = \{|u\rangle, |a_1\rangle, \dots, |a_{N-1}\rangle\}$. Then

$$\begin{aligned} \mathbf{T}|u\rangle &= \mathbf{T}_U |u\rangle + \mathbf{T}_W |u\rangle = \mathbf{P}_U \mathbf{T}|u\rangle + \mathbf{P}_W \mathbf{T}|u\rangle \\ &= \mathbf{P}_U (\lambda|u\rangle) + \underbrace{\mathbf{P}_W (\lambda|u\rangle)}_{=|0\rangle} = \lambda|u\rangle \in \text{Span}\{|u\rangle\} \end{aligned}$$

and

$$\begin{aligned} \mathbf{T}|a_i\rangle &= \mathbf{T}_U |a_i\rangle + \mathbf{T}_W |a_i\rangle = \underbrace{\mathbf{P}_U (\mathbf{T}|a_i\rangle)}_{\in \mathcal{U}} + \mathbf{T}_W |a_i\rangle \\ &= \alpha|u\rangle + \sum_{k=1}^i \alpha_k |a_k\rangle \in \text{Span}\{|u\rangle, |a_1\rangle, \dots, |a_i\rangle\}, \end{aligned}$$

where we used the fact that $\mathbf{T}_W |a_i\rangle \in \text{Span}\{|a_k\rangle\}_{k=1}^i$. We thus have found a basis B_V for which Eq. (6.10) holds. This completes the proof. \square

The ideal goal of the representation of an operator is to have it in diagonal form with its eigenvalues along the diagonal. Theorem 6.3.2 partially accomplished this for complex vector spaces: it made the lower half of the representing matrix all zeros. In doing so, it used the algebraic closure of \mathbb{C} , i.e., the fact that any polynomial with coefficients in \mathbb{C} has all its roots in \mathbb{C} . To make the upper half also zero, additional properties will be required for the operator, as we’ll see in Sect. 6.4. Thus, for a general operator on a complex vector space, upper-triangular representation is the best we can accomplish. The case of the real vector spaces is even more restrictive as we shall see in Sect. 6.6.

6.4 Complex Spectral Decomposition

This section derives one of the most powerful theorems in the theory of linear operators, the spectral decomposition theorem. We shall derive the theorem for operators that generalize hermitian and unitary operators.

Definition 6.4.1 A **normal operator** is an operator on an inner product space that commutes with its adjoint. normal operator defined

An important consequence of this definition is

Proposition 6.4.2 *The operator $\mathbf{A} \in \text{End}(\mathcal{V})$ satisfies*

$$\|\mathbf{A}x\| = \|\mathbf{A}^\dagger x\| \quad \text{for all } |x\rangle \in \mathcal{V} \quad (6.11)$$

if and only if \mathbf{A} is normal.

Theorem 6.4.3 *Let \mathbf{A} be a normal operator on \mathcal{V} and \mathcal{U} a subspace of \mathcal{V} invariant under \mathbf{A} . Then \mathcal{U} is invariant under \mathbf{A}^\dagger . Therefore by Theorem 6.1.6, any invariant subspace of a normal operator reduces it.*

Proof Let $\{|e_i\rangle\}_{i=1}^m$ be an orthonormal basis of \mathcal{U} , and extend it to get $\{|e_i\rangle\}_{i=1}^N$, an orthonormal basis of \mathcal{V} . Since \mathcal{U} is invariant under \mathbf{A} , we can write

$$\mathbf{A}|e_i\rangle = \sum_{j=1}^m \alpha_{ji} |e_j\rangle, \quad \alpha_{ji} = \langle e_j | \mathbf{A} | e_i \rangle$$

and

$$\mathbf{A}^\dagger |e_i\rangle = \sum_{j=1}^m \eta_{ji} |e_j\rangle + \sum_{j=m+1}^N \xi_{ji} |e_j\rangle,$$

where for $j = 1, 2, \dots, m$, we have

$$\eta_{ji} = \langle e_j | \mathbf{A}^\dagger | e_i \rangle = \langle e_i | \mathbf{A} | e_j \rangle^* = \alpha_{ij}^*.$$

Now note that

$$\langle e_i | \mathbf{A}^\dagger \mathbf{A} | e_i \rangle = \sum_{j=1}^m |\alpha_{ij}|^2$$

while

$$\langle e_i | \mathbf{A} \mathbf{A}^\dagger | e_i \rangle = \sum_{j=1}^m |\eta_{ji}|^2 + \sum_{j=m+1}^N |\xi_{ji}|^2 = \sum_{j=1}^m |\alpha_{ij}|^2 + \sum_{j=m+1}^N |\xi_{ij}|^2.$$

Since $\mathbf{A}^\dagger \mathbf{A} = \mathbf{A} \mathbf{A}^\dagger$, we must have

$$\sum_{j=1}^m |\alpha_{ij}|^2 = \sum_{j=1}^m |\alpha_{ij}|^2 + \sum_{j=m+1}^N |\xi_{ij}|^2$$

or

$$\sum_{j=m+1}^N |\xi_{ij}|^2 = 0 \Rightarrow \xi_{ij} = 0 \quad \text{for all } i, j = m+1, \dots, N.$$

This implies that \mathbf{A}^\dagger sends every basis vector of \mathcal{U} back to \mathcal{U} , and therefore it does the same for every vector of \mathcal{U} . \square

Proposition 6.4.4 *Let \mathbf{A} be a normal operator on \mathcal{V} . Then $|x\rangle$ is an eigenvector of \mathbf{A} with eigenvalue λ if and only if $|x\rangle$ is an eigenvector of \mathbf{A}^\dagger with eigenvalue λ^* .*

Proof By Proposition 6.4.2, the fact that $(\mathbf{A} - \lambda\mathbf{1})^\dagger = \mathbf{A}^\dagger - \lambda^*\mathbf{1}$, and the fact that $\mathbf{A} - \lambda\mathbf{1}$ is normal (reader, verify), we have $\|(\mathbf{A} - \lambda\mathbf{1})x\| = 0$ if and only if $\|(\mathbf{A}^\dagger - \lambda^*\mathbf{1})x\| = 0$. Since it is only the zero vector that has the zero norm, we get

$$(\mathbf{A} - \lambda\mathbf{1})|x\rangle = 0 \quad \text{if and only if} \quad (\mathbf{A}^\dagger - \lambda^*\mathbf{1})|x\rangle = 0.$$

This proves the proposition. \square

We obtain a useful consequence of this proposition by applying it to a hermitian operator \mathbf{H} and a unitary operator³ \mathbf{U} . In the first case, we get

$$\mathbf{H}|x\rangle = \lambda|x\rangle = \mathbf{H}^\dagger|x\rangle = \lambda^*|x\rangle \Rightarrow (\lambda - \lambda^*)|x\rangle = 0 \Rightarrow \lambda = \lambda^*.$$

Therefore, λ is real. In the second case, we write

$$|x\rangle = \mathbf{1}|x\rangle = \mathbf{U}\mathbf{U}^\dagger|x\rangle = \mathbf{U}(\lambda^*|x\rangle) = \lambda^*\mathbf{U}|x\rangle = \lambda^*\lambda|x\rangle \Rightarrow \lambda^*\lambda = 1.$$

Therefore, λ is unimodular (has absolute value equal to 1). We summarize the foregoing discussion:

Corollary 6.4.5 *The eigenvalues of a hermitian operator are real. A unitary operator has eigenvalues whose absolute values are 1.*

Example 6.4.6 Let us find the eigenvalues and eigenvectors of the hermitian matrix $\mathbf{H} = \begin{pmatrix} 0 & -i \\ i & 0 \end{pmatrix}$. We have

$$\det(\mathbf{H} - \lambda\mathbf{1}) = \det \begin{pmatrix} -\lambda & -i \\ i & -\lambda \end{pmatrix} = \lambda^2 - 1.$$

Thus, the eigenvalues, $\lambda_1 = 1$ and $\lambda_2 = -1$, are real, as expected.

³Obviously, both are normal operators.

To find the eigenvectors, we write

$$0 = (\mathbf{H} - \lambda_1 \mathbf{1})|a_1\rangle = (\mathbf{H} - \mathbf{1})|a_1\rangle = \begin{pmatrix} -1 & -i \\ i & -1 \end{pmatrix} \begin{pmatrix} \alpha_1 \\ \alpha_2 \end{pmatrix} = \begin{pmatrix} -\alpha_1 - i\alpha_2 \\ i\alpha_1 - \alpha_2 \end{pmatrix},$$

or $\alpha_2 = i\alpha_1$, which gives $|a_1\rangle = \begin{pmatrix} \alpha_1 \\ i\alpha_1 \end{pmatrix} = \alpha_1 \begin{pmatrix} 1 \\ i \end{pmatrix}$, where α_1 is an arbitrary complex number. Also,

$$0 = (\mathbf{H} - \lambda_2 \mathbf{1})|a_2\rangle = (\mathbf{H} + \mathbf{1})|a_2\rangle = \begin{pmatrix} 1 & -i \\ i & 1 \end{pmatrix} \begin{pmatrix} \beta_1 \\ \beta_2 \end{pmatrix} = \begin{pmatrix} \beta_1 - i\beta_2 \\ i\beta_1 + \beta_2 \end{pmatrix},$$

or $\beta_2 = -i\beta_1$, which gives $|a_2\rangle = \begin{pmatrix} \beta_1 \\ -i\beta_1 \end{pmatrix} = \beta_1 \begin{pmatrix} 1 \\ -i \end{pmatrix}$, where β_1 is an arbitrary complex number.

It is desirable, in most situations, to orthonormalize the eigenvectors. In the present case, they are already orthogonal. This is a property shared by all eigenvectors of a hermitian (in fact, normal) operator stated in the next theorem. We therefore need to merely normalize the eigenvectors:

Always normalize the eigenvectors!

$$1 = \langle a_1 | a_1 \rangle = \alpha_1^* (1 \quad -i) \alpha_1 \begin{pmatrix} 1 \\ i \end{pmatrix} = 2|\alpha_1|^2,$$

or $|\alpha_1| = 1/\sqrt{2}$ and $\alpha_1 = e^{i\varphi}/\sqrt{2}$ for some $\varphi \in \mathbb{R}$. A similar result is obtained for β_1 . The choice $\varphi = 0$ yields

$$|e_1\rangle = \frac{1}{\sqrt{2}} \begin{pmatrix} 1 \\ i \end{pmatrix} \quad \text{and} \quad |e_2\rangle = \frac{1}{\sqrt{2}} \begin{pmatrix} 1 \\ -i \end{pmatrix}.$$

The following theorem proves for all normal operators the orthogonality property of their eigenvectors illustrated in the example above for a simple hermitian operator.

Theorem 6.4.7 *An eigenspace of a normal operator reduces that operator. Moreover, eigenspaces of a normal operator are mutually orthogonal.*

Proof The first part of the theorem is a trivial consequence of Theorem 6.4.3. To prove the second part, let $|u\rangle \in \mathcal{M}_\lambda$ and $|v\rangle \in \mathcal{M}_\mu$ with $\lambda \neq \mu$. Then, using Theorem 6.1.6 once more, we obtain

$$\lambda \langle v | u \rangle = \langle v | \lambda u \rangle = \langle v | \mathbf{A}u \rangle = \langle \mathbf{A}^\dagger v | u \rangle = \langle \mu^* v | u \rangle = \mu \langle v | u \rangle.$$

It follows that $(\lambda - \mu) \langle v | u \rangle = 0$ and since $\lambda \neq \mu$, $\langle v | u \rangle = 0$. \square

Theorem 6.4.8 (Complex Spectral Decomposition) *Let \mathbf{A} be a normal operator on a finite-dimensional complex inner product space \mathcal{V} . Let $\lambda_1, \lambda_2, \dots, \lambda_r$ be its distinct eigenvalues. Then*

$$\mathcal{V} = \mathcal{M}_1 \oplus \mathcal{M}_2 \oplus \dots \oplus \mathcal{M}_r,$$

and the nonzero (hermitian) projection operators $\mathbf{P}_1, \mathbf{P}_2, \dots, \mathbf{P}_r$, where \mathbf{P}_j projects onto \mathcal{M}_j , satisfy

$$(1) \quad \mathbf{1} = \sum_{j=1}^r \mathbf{P}_j, \quad (2) \quad \mathbf{P}_i \mathbf{P}_j = 0 \quad \text{for } i \neq j,$$

$$(3) \quad \mathbf{A} = \sum_{j=1}^r \lambda_j \mathbf{P}_j.$$

Proof Let \mathbf{P}_i be the operator that projects onto the eigenspace \mathcal{M}_i corresponding to eigenvalue λ_i . The fact that at least one such eigenspace exists is guaranteed by Theorem 6.2.5. By Proposition 6.1.3, these projection operators are hermitian. Because of Theorem 6.4.7 [see also Eq. (6.6)], the only vector common to any two distinct eigenspaces is the zero vector. So, it makes sense to talk about the direct sum of these eigenspaces. Let

$$\mathcal{M} = \mathcal{M}_1 \oplus \mathcal{M}_2 \oplus \dots \oplus \mathcal{M}_r$$

and $\mathbf{P} = \sum_{i=1}^r \mathbf{P}_i$, where \mathbf{P} is the orthogonal projection operator onto \mathcal{M} . Since \mathbf{A} commutes with every \mathbf{P}_i (Theorem 6.1.8), it commutes with \mathbf{P} . Hence, by Theorem 6.1.8, \mathcal{M} reduces \mathbf{A} , i.e., \mathcal{M}^\perp is also invariant under \mathbf{A} . Now regard the restriction of \mathbf{A} to \mathcal{M}^\perp as an operator in its own right on the finite-dimensional vector space \mathcal{M}^\perp . Theorem 6.2.5 now forces \mathbf{A} to have at least one eigenvector in \mathcal{M}^\perp . But this is impossible because all eigenvectors of \mathbf{A} have been accounted for in its eigenspaces. The only resolution is for \mathcal{M}^\perp to be zero. This gives

$$\mathcal{V} = \mathcal{M}_1 \oplus \mathcal{M}_2 \oplus \dots \oplus \mathcal{M}_r \quad \text{and} \quad \mathbf{1} = \sum_{i=1}^r \mathbf{P}_i.$$

The second equation follows from the first and Eqs. (6.1) and (6.2). The remaining part of the theorem follows from arguments similar to those used in the proof of Theorem 6.2.10. \square

We can now establish the connection between the diagonalizability of a normal operator and the spectral theorem. In each subspace \mathcal{M}_i , we choose an orthonormal basis. The union of all these bases is clearly a basis for the whole space \mathcal{V} . Let us label these basis vectors $|e_j^s\rangle$, where the subscript indicates the subspace and the superscript indicates the particular vector in that subspace. Clearly, $\langle e_j^s | e_{j'}^{s'} \rangle = \delta_{ss'} \delta_{jj'}$ and $\mathbf{P}_j = \sum_{s=1}^{m_j} |e_j^s\rangle \langle e_j^s|$. Noting that $\mathbf{P}_k |e_{j'}^{s'}\rangle = \delta_{kj'} |e_{j'}^{s'}\rangle$, we can obtain the matrix elements of \mathbf{A} in such a basis:

$$\langle e_j^s | \mathbf{A} | e_{j'}^{s'} \rangle = \sum_{i=1}^r \lambda_i \langle e_j^s | \mathbf{P}_i | e_{j'}^{s'} \rangle = \sum_{i=1}^r \lambda_i \delta_{ij'} \langle e_j^s | e_{j'}^{s'} \rangle = \lambda_{j'} \langle e_j^s | e_{j'}^{s'} \rangle.$$

Only the diagonal elements are nonzero. We note that for each subscript j we have m_j orthonormal vectors $|e_j^\alpha\rangle$, where m_j is the dimension of \mathcal{M}_j . Thus, λ_j occurs m_j times as a diagonal element. Therefore, in such an orthonormal basis, \mathbf{A} will be represented by

$$\text{diag}(\underbrace{\lambda_1, \dots, \lambda_1}_{m_1 \text{ times}}, \underbrace{\lambda_2, \dots, \lambda_2}_{m_2 \text{ times}}, \dots, \underbrace{\lambda_r, \dots, \lambda_r}_{m_r \text{ times}}).$$

Let us summarize the preceding discussion:

Corollary 6.4.9 *If $\mathbf{A} \in \text{End}(\mathcal{V})$ is normal, then \mathcal{V} has an orthonormal basis consisting of eigenvectors of \mathbf{A} . Therefore, a normal operator on a complex inner product space is diagonalizable.*

Using this corollary, the reader may show the following:

Corollary 6.4.10 *A hermitian operator is positive if and only if all its eigenvalues are positive.*

In light of Corollary 6.4.9, Theorems 6.2.10 and 6.4.8 are converses of one another. In fact, it is straightforward to show that diagonalizability implies normality. Hence, we have

Proposition 6.4.11 *An operator on a complex inner product space is normal iff it is diagonalizable.*

Example 6.4.12 (Computation of largest and smallest eigenvalues) There is an elegant technique that yields the largest and the smallest (in absolute value) eigenvalues of a normal operator \mathbf{A} in a straightforward way if the eigenspaces of these eigenvalues are one dimensional. For convenience, assume that the eigenvalues are labeled in order of decreasing absolute values:

$$|\lambda_1| > |\lambda_2| > \dots > |\lambda_r| \neq 0.$$

Let $\{|a_k\rangle\}_{k=1}^N$ be a basis of \mathcal{V} consisting of eigenvectors of \mathbf{A} , and $|x\rangle = \sum_{k=1}^N \xi_k |a_k\rangle$ an arbitrary vector in \mathcal{V} . Then

$$\mathbf{A}^m |x\rangle = \sum_{k=1}^N \xi_k \mathbf{A}^m |a_k\rangle = \sum_{k=1}^N \xi_k \lambda_k^m |a_k\rangle = \lambda_1^m \left[\xi_1 |a_1\rangle + \sum_{k=2}^N \xi_k \left(\frac{\lambda_k}{\lambda_1}\right)^m |a_k\rangle \right].$$

In the limit $m \rightarrow \infty$, the summation in the brackets vanishes. Therefore,

$$\mathbf{A}^m |x\rangle \approx \lambda_1^m \xi_1 |a_1\rangle \quad \text{and} \quad \langle y | \mathbf{A}^m |x\rangle \approx \lambda_1^m \xi_1 \langle y | a_1\rangle$$

for any $|y\rangle \in \mathcal{V}$. Taking the ratio of this equation and the corresponding one for $m + 1$, we obtain

$$\lim_{m \rightarrow \infty} \frac{\langle y | \mathbf{A}^{m+1} |x\rangle}{\langle y | \mathbf{A}^m |x\rangle} = \lambda_1.$$

Computation of the largest and the smallest eigenvalues of a normal operator

Note how crucially this relation depends on the fact that λ_1 is nondegenerate, i.e., that \mathcal{M}_1 is one-dimensional. By taking larger and larger values for m , we can obtain a better and better approximation to the largest eigenvalue.

Assuming that zero is not the smallest eigenvalue λ_r —and therefore not an eigenvalue—of \mathbf{A} , we can find the smallest eigenvalue by replacing \mathbf{A} with \mathbf{A}^{-1} and λ_1 with $1/\lambda_r$. The details are left as an exercise for the reader.

A hermitian matrix can be diagonalized by a unitary matrix.

Any given hermitian matrix \mathbf{H} can be thought of as the representation of a hermitian operator in the standard orthonormal basis. We can find a unitary matrix \mathbf{U} that can transform the standard basis to the orthonormal basis consisting of $|e_j^s\rangle$, the eigenvectors of the hermitian operator. The representation of the hermitian operator in the new basis is $\mathbf{U}\mathbf{H}\mathbf{U}^\dagger$, as discussed in Sect. 5.3. However, the above argument showed that the new matrix is diagonal. We therefore have the following result.

Corollary 6.4.13 *A hermitian matrix can always be brought to diagonal form by means of a unitary transformation matrix.*

Example 6.4.14 Let us consider the diagonalization of the hermitian matrix

$$\mathbf{H} = \begin{pmatrix} 0 & 0 & -1+i & -1-i \\ 0 & 0 & -1+i & 1+i \\ -1-i & -1-i & 0 & 0 \\ -1+i & 1-i & 0 & 0 \end{pmatrix}.$$

The characteristic polynomial is $\det(\mathbf{H} - \lambda\mathbf{1}) = (\lambda + 2)^2(\lambda - 2)^2$. Thus, $\lambda_1 = -2$ with multiplicity $m_1 = 2$, and $\lambda_2 = 2$ with multiplicity $m_2 = 2$. To find the eigenvectors, we first look at the matrix equation $(\mathbf{H} + 2\mathbf{1})|a\rangle = 0$, or

$$\begin{pmatrix} 2 & 0 & -1+i & -1-i \\ 0 & 2 & -1+i & 1+i \\ -1-i & -1-i & 2 & 0 \\ -1+i & 1-i & 0 & 2 \end{pmatrix} \begin{pmatrix} \alpha_1 \\ \alpha_2 \\ \alpha_3 \\ \alpha_4 \end{pmatrix} = 0.$$

This is a system of linear equations whose “solution” is

$$\alpha_3 = \frac{1}{2}(1+i)(\alpha_1 + \alpha_2), \quad \alpha_4 = \frac{1}{2}(1-i)(\alpha_1 - \alpha_2).$$

We have two arbitrary parameters, so we expect two linearly independent solutions. For the two choices $\alpha_1 = 2, \alpha_2 = 0$ and $\alpha_1 = 0, \alpha_2 = 2$, we obtain, respectively,

$$|a_1\rangle = \begin{pmatrix} 2 \\ 0 \\ 1+i \\ 1-i \end{pmatrix} \quad \text{and} \quad |a_2\rangle = \begin{pmatrix} 0 \\ 2 \\ 1+i \\ -1+i \end{pmatrix},$$

which happen to be orthogonal. We simply normalize them to obtain

$$|e_1\rangle = \frac{1}{2\sqrt{2}} \begin{pmatrix} 2 \\ 0 \\ 1+i \\ 1-i \end{pmatrix} \quad \text{and} \quad |e_2\rangle = \frac{1}{2\sqrt{2}} \begin{pmatrix} 0 \\ 2 \\ 1+i \\ -1+i \end{pmatrix}.$$

Similarly, the second eigenvalue equation, $(H - 21)|a\rangle = 0$, gives rise to the conditions $\alpha_3 = -\frac{1}{2}(1+i)(\alpha_1 + \alpha_2)$ and $\alpha_4 = -\frac{1}{2}(1-i)(\alpha_1 - \alpha_2)$, which produce the orthonormal vectors

$$|e_3\rangle = \frac{1}{2\sqrt{2}} \begin{pmatrix} 2 \\ 0 \\ -1-i \\ -1+i \end{pmatrix} \quad \text{and} \quad |e_4\rangle = \frac{1}{2\sqrt{2}} \begin{pmatrix} 0 \\ 2 \\ -1-i \\ 1-i \end{pmatrix}.$$

The unitary matrix that diagonalizes H can be constructed from these column vectors using the remarks before Example 5.4.4, which imply that if we simply put the vectors $|e_i\rangle$ together as columns, the resulting matrix is U^\dagger :

$$U^\dagger = \frac{1}{2\sqrt{2}} \begin{pmatrix} 2 & 0 & 2 & 0 \\ 0 & 2 & 0 & 2 \\ 1+i & 1+i & -1-i & -1-i \\ 1-i & -1+i & -1+i & 1-i \end{pmatrix},$$

and the unitary matrix will be

$$U = (U^\dagger)^\dagger = \frac{1}{2\sqrt{2}} \begin{pmatrix} 2 & 0 & 1-i & 1+i \\ 0 & 2 & 1-i & -1-i \\ 2 & 0 & -1+i & -1-i \\ 0 & 2 & -1+i & 1+i \end{pmatrix}.$$

We can easily check that U diagonalizes H , i.e., that UHU^\dagger is diagonal.

Example 6.4.15 In some physical applications the ability to diagonalize matrices can be very useful. As a simple but illustrative example, let us consider the motion of a charged particle in a constant magnetic field pointing in the z direction. The equation of motion for such a particle is

application of
diagonalization in
electromagnetism

$$m \frac{d\mathbf{v}}{dt} = q\mathbf{v} \times \mathbf{B} = q \det \begin{pmatrix} \hat{\mathbf{e}}_x & \hat{\mathbf{e}}_y & \hat{\mathbf{e}}_z \\ v_x & v_y & v_z \\ 0 & 0 & B \end{pmatrix},$$

which in component form becomes

$$\frac{dv_x}{dt} = \frac{qB}{m}v_y, \quad \frac{dv_y}{dt} = -\frac{qB}{m}v_x, \quad \frac{dv_z}{dt} = 0.$$

Ignoring the uniform motion in the z direction, we need to solve the first two coupled equations, which in matrix form becomes

$$\frac{d}{dt} \begin{pmatrix} v_x \\ v_y \end{pmatrix} = \frac{qB}{m} \begin{pmatrix} 0 & 1 \\ -1 & 0 \end{pmatrix} \begin{pmatrix} v_x \\ v_y \end{pmatrix} = -i\omega \begin{pmatrix} 0 & i \\ -i & 0 \end{pmatrix} \begin{pmatrix} v_x \\ v_y \end{pmatrix}, \quad (6.12)$$

where we have introduced a factor of i to render the matrix hermitian, and defined $\omega = qB/m$. If the 2×2 matrix were diagonal, we would get two *uncoupled* equations, which we could solve easily. Diagonalizing the matrix involves finding a matrix R such that

$$D = R \begin{pmatrix} 0 & i \\ -i & 0 \end{pmatrix} R^{-1} = \begin{pmatrix} \mu_1 & 0 \\ 0 & \mu_2 \end{pmatrix}.$$

If we could do such a diagonalization, we would multiply (6.12) by R to get⁴

$$\frac{d}{dt} R \begin{pmatrix} v_x \\ v_y \end{pmatrix} = -i\omega R \begin{pmatrix} 0 & i \\ -i & 0 \end{pmatrix} R^{-1} R \begin{pmatrix} v_x \\ v_y \end{pmatrix},$$

which can be written as

$$\frac{d}{dt} \begin{pmatrix} v'_x \\ v'_y \end{pmatrix} = -i\omega \begin{pmatrix} \mu_1 & 0 \\ 0 & \mu_2 \end{pmatrix} \begin{pmatrix} v'_x \\ v'_y \end{pmatrix} = \begin{pmatrix} -i\omega\mu_1 v'_x \\ -i\omega\mu_2 v'_y \end{pmatrix}, \quad \text{where}$$

$$\begin{pmatrix} v'_x \\ v'_y \end{pmatrix} \equiv R \begin{pmatrix} v_x \\ v_y \end{pmatrix}.$$

We then would have a pair of uncoupled equations

$$\frac{dv'_x}{dt} = -i\omega\mu_1 v'_x, \quad \frac{dv'_y}{dt} = -i\omega\mu_2 v'_y$$

that have $v'_x = v'_{0x} e^{-i\omega\mu_1 t}$ and $v'_y = v'_{0y} e^{-i\omega\mu_2 t}$ as a solution set, in which v'_{0x} and v'_{0y} are integration constants.

To find R , we need the normalized eigenvectors of $\begin{pmatrix} 0 & i \\ -i & 0 \end{pmatrix}$. But these are obtained in precisely the same fashion as in Example 6.4.6. There is, however, an arbitrariness in the solutions due to the choice in numbering the eigenvalues. If we choose the normalized eigenvectors

$$|e_1\rangle = \frac{1}{\sqrt{2}} \begin{pmatrix} i \\ 1 \end{pmatrix}, \quad |e_2\rangle = \frac{1}{\sqrt{2}} \begin{pmatrix} -i \\ 1 \end{pmatrix},$$

⁴The fact that R is independent of t is crucial in this step. This fact, in turn, is a consequence of the independence from t of the original 2×2 matrix.

then from comments at the end of Sect. 5.3, we get

$$\mathbf{R}^{-1} = \mathbf{R}^\dagger = \frac{1}{\sqrt{2}} \begin{pmatrix} i & -i \\ 1 & 1 \end{pmatrix} \Rightarrow \mathbf{R} = (\mathbf{R}^\dagger)^\dagger = \frac{1}{\sqrt{2}} \begin{pmatrix} -i & 1 \\ i & 1 \end{pmatrix}.$$

With this choice of \mathbf{R} , we have

$$\mathbf{R} \begin{pmatrix} 0 & i \\ -i & 0 \end{pmatrix} \mathbf{R}^{-1} = \begin{pmatrix} 1 & 0 \\ 0 & -1 \end{pmatrix},$$

so that $\mu_1 = 1 = -\mu_2$. Having found \mathbf{R}^\dagger , we can write

$$\begin{pmatrix} v_x \\ v_y \end{pmatrix} = \mathbf{R}^\dagger \begin{pmatrix} v'_x \\ v'_y \end{pmatrix} = \frac{1}{\sqrt{2}} \begin{pmatrix} i & -i \\ 1 & 1 \end{pmatrix} \begin{pmatrix} v'_{0x} e^{-i\omega t} \\ v'_{0y} e^{i\omega t} \end{pmatrix}. \quad (6.13)$$

If the x and y components of velocity at $t = 0$ are v_{0x} and v_{0y} , respectively, then

$$\begin{pmatrix} v_{0x} \\ v_{0y} \end{pmatrix} = \mathbf{R}^\dagger \begin{pmatrix} v'_{0x} \\ v'_{0y} \end{pmatrix}, \quad \text{or} \quad \begin{pmatrix} v'_{0x} \\ v'_{0y} \end{pmatrix} = \mathbf{R} \begin{pmatrix} v_{0x} \\ v_{0y} \end{pmatrix} = \frac{1}{\sqrt{2}} \begin{pmatrix} -i v_{0x} + v_{0y} \\ i v_{0x} + v_{0y} \end{pmatrix}.$$

Substituting in (6.13), we obtain

$$\begin{aligned} \begin{pmatrix} v_x \\ v_y \end{pmatrix} &= \frac{1}{2} \begin{pmatrix} i & -i \\ 1 & 1 \end{pmatrix} \begin{pmatrix} (-i v_{0x} + v_{0y}) e^{-i\omega t} \\ (i v_{0x} + v_{0y}) e^{i\omega t} \end{pmatrix} \\ &= \begin{pmatrix} v_{0x} \cos \omega t + v_{0y} \sin \omega t \\ -v_{0x} \sin \omega t + v_{0y} \cos \omega t \end{pmatrix}. \end{aligned}$$

This gives the velocity as a function of time. Antidifferentiating once with respect to time yields the position vector.

6.4.1 Simultaneous Diagonalization

In many situations of physical interest, it is desirable to know whether two operators are simultaneously diagonalizable. For instance, if there exists a basis of a Hilbert space of a quantum-mechanical system consisting of simultaneous eigenvectors of two operators, then one can measure those two operators at the same time. In particular, they are not restricted by an uncertainty relation.

Definition 6.4.16 Two operators are said to be **simultaneously diagonalizable** if they can be written in terms of the same set of projection operators, as in Theorem 6.4.8.

simultaneous
diagonalization defined

This definition is consistent with the matrix representation of the two operators, because if we take the orthonormal basis $B = \{|e_j^s\rangle\}$ discussed right after Theorem 6.4.8, we obtain diagonal matrices for both operators. What are the conditions under which two operators can be simultaneously diagonalized? Clearly, a necessary condition is that the two operators commute.

This is an immediate consequence of the orthogonality of the projection operators, which trivially implies $\mathbf{P}_i \mathbf{P}_j = \mathbf{P}_j \mathbf{P}_i$ for all i and j . It is also apparent in the matrix representation of the operators: Any two diagonal matrices commute. What about sufficiency? Is the commutativity of the two operators sufficient for them to be simultaneously diagonalizable? To answer this question, we need the following lemma:

Lemma 6.4.17 *An operator \mathbf{T} commutes with a normal operator \mathbf{A} if and only if \mathbf{T} commutes with all the projection operators of \mathbf{A} .*

Proof The “if” part is trivial. To prove the “only if” part, suppose $\mathbf{AT} = \mathbf{TA}$, and let $|x\rangle$ be any vector in one of the eigenspaces of \mathbf{A} , say \mathcal{M}_j . Then we have $\mathbf{A}(\mathbf{T}|x\rangle) = \mathbf{T}(\mathbf{A}|x\rangle) = \mathbf{T}(\lambda_j|x\rangle) = \lambda_j(\mathbf{T}|x\rangle)$; i.e., $\mathbf{T}|x\rangle$ is in \mathcal{M}_j , or \mathcal{M}_j is invariant under \mathbf{T} . Since \mathcal{M}_j is arbitrary, \mathbf{T} leaves all eigenspaces invariant. In particular, it leaves \mathcal{M}_j^\perp , the orthogonal complement of \mathcal{M}_j (the direct sum of all the remaining eigenspaces), invariant. By Theorems 6.1.6 and 6.1.8, $\mathbf{TP}_j = \mathbf{P}_j\mathbf{T}$; and this holds for all j . \square

necessary and sufficient
condition for
simultaneous
diagonalizability

Theorem 6.4.18 *Two normal operators \mathbf{A} and \mathbf{B} are simultaneously diagonalizable iff $[\mathbf{A}, \mathbf{B}] = \mathbf{0}$.*

Proof As claimed above, the “necessity” is trivial. To prove the “sufficiency”, let

$$\mathbf{A} = \sum_{j=1}^r \lambda_j \mathbf{P}_j \quad \text{and} \quad \mathbf{B} = \sum_{\alpha=1}^s \mu_\alpha \mathbf{Q}_\alpha,$$

where $\{\lambda_j\}$ and $\{\mathbf{P}_j\}$ are eigenvalues and projections of \mathbf{A} , and $\{\mu_\alpha\}$ and $\{\mathbf{Q}_\alpha\}$ are those of \mathbf{B} . Assume $[\mathbf{A}, \mathbf{B}] = \mathbf{0}$. Then by Lemma 6.4.17, $\mathbf{A}\mathbf{Q}_\alpha = \mathbf{Q}_\alpha\mathbf{A}$. Since \mathbf{Q}_α commutes with \mathbf{A} , it must commute with the latter’s projection operators: $\mathbf{P}_j\mathbf{Q}_\alpha = \mathbf{Q}_\alpha\mathbf{P}_j$. Now define $\mathbf{R}_{j\alpha} \equiv \mathbf{P}_j\mathbf{Q}_\alpha$, and note that

$$\begin{aligned} \mathbf{R}_{j\alpha}^\dagger &= (\mathbf{P}_j\mathbf{Q}_\alpha)^\dagger = \mathbf{Q}_\alpha^\dagger\mathbf{P}_j^\dagger = \mathbf{Q}_\alpha\mathbf{P}_j = \mathbf{P}_j\mathbf{Q}_\alpha = \mathbf{R}_{j\alpha}, \\ (\mathbf{R}_{j\alpha})^2 &= (\mathbf{P}_j\mathbf{Q}_\alpha)^2 = \mathbf{P}_j\mathbf{Q}_\alpha\mathbf{P}_j\mathbf{Q}_\alpha = \mathbf{P}_j\mathbf{P}_j\mathbf{Q}_\alpha\mathbf{Q}_\alpha = \mathbf{P}_j\mathbf{Q}_\alpha = \mathbf{R}_{j\alpha}. \end{aligned}$$

Therefore, $\mathbf{R}_{j\alpha}$ are hermitian projection operators. In fact, they are the projection operators that project onto the intersection of the eigenspaces of \mathbf{A} and \mathbf{B} . Furthermore,

$$\sum_{j=1}^r \mathbf{R}_{j\alpha} = \sum_{j=1}^r \underbrace{\mathbf{P}_j}_{=\mathbf{1}} \mathbf{Q}_\alpha = \mathbf{Q}_\alpha,$$

and similarly, $\sum_{\alpha=1}^s \mathbf{R}_{j\alpha} = \mathbf{P}_j$. Since,

$$\sum_{j,\alpha} \mathbf{R}_{j\alpha} = \sum_{\alpha} \mathbf{Q}_\alpha = \mathbf{1},$$

not all $\mathbf{R}_{j\alpha}$ can be zero. In fact, because of this identity, we must have

$$\mathcal{V} = \bigoplus_{j,\alpha} \mathcal{M}_j \cap \mathcal{N}_\alpha$$

where \mathcal{M}_j and \mathcal{N}_α are the eigenspaces of \mathbf{A} and \mathbf{B} , respectively. We can now write \mathbf{A} and \mathbf{B} as

$$\mathbf{A} = \sum_j \lambda_j \mathbf{P}_j = \sum_{j,\alpha} \lambda_j \mathbf{R}_{j\alpha}, \quad \mathbf{B} = \sum_\alpha \mu_\alpha \mathbf{Q}_\alpha = \sum_{j,\alpha} \mu_\alpha \mathbf{R}_{j\alpha}.$$

By definition, they are simultaneously diagonalizable. \square

Example 6.4.19 Let us find the spectral decomposition of the Pauli spin matrix spectral decomposition
of a Pauli spin matrix

$$\sigma_2 = \begin{pmatrix} 0 & -i \\ i & 0 \end{pmatrix}.$$

The eigenvalues and eigenvectors have been found in Example 6.4.6. These are

$$\lambda_1 = 1, \quad |e_1\rangle = \frac{1}{\sqrt{2}} \begin{pmatrix} 1 \\ i \end{pmatrix} \quad \text{and} \quad \lambda_2 = -1, \quad |e_2\rangle = \frac{1}{\sqrt{2}} \begin{pmatrix} 1 \\ -i \end{pmatrix}.$$

The subspaces \mathcal{M}_{λ_j} are one-dimensional; therefore,

$$\mathbf{P}_1 = |e_1\rangle\langle e_1| = \frac{1}{\sqrt{2}} \begin{pmatrix} 1 \\ i \end{pmatrix} \frac{1}{\sqrt{2}} (1 \quad -i) = \frac{1}{2} \begin{pmatrix} 1 & -i \\ i & 1 \end{pmatrix},$$

$$\mathbf{P}_2 = |e_2\rangle\langle e_2| = \frac{1}{2} \begin{pmatrix} 1 \\ -i \end{pmatrix} (1 \quad i) = \frac{1}{2} \begin{pmatrix} 1 & i \\ -i & 1 \end{pmatrix}.$$

We can check that $\mathbf{P}_1 + \mathbf{P}_2 = \begin{pmatrix} 1 & 0 \\ 0 & 1 \end{pmatrix}$ and

$$\lambda_1 \mathbf{P}_1 + \lambda_2 \mathbf{P}_2 = \frac{1}{2} \begin{pmatrix} 1 & -i \\ i & 1 \end{pmatrix} - \frac{1}{2} \begin{pmatrix} 1 & i \\ -i & 1 \end{pmatrix} = \begin{pmatrix} 0 & -i \\ i & 0 \end{pmatrix} = \sigma_2.$$

Example 6.4.20 In this example, we provide another proof that if \mathbf{T} is diagonalizable, then it must be normal. We saw in Chap. 4 that \mathbf{T} can be written in terms of its so-called Cartesian components as $\mathbf{T} = \mathbf{X} + i\mathbf{Y}$ where both \mathbf{X} and \mathbf{Y} are hermitian and can therefore be decomposed according to Theorem 6.4.8. Can we conclude that \mathbf{T} is also decomposable? No. Because the projection operators used in the decomposition of \mathbf{X} may not be the same as those used for \mathbf{Y} . However, if \mathbf{X} and \mathbf{Y} are simultaneously diagonalizable such that⁵

$$\mathbf{X} = \sum_{k=1}^r \lambda_k \mathbf{P}_k \quad \text{and} \quad \mathbf{Y} = \sum_{k=1}^r \lambda'_k \mathbf{P}_k, \quad (6.14)$$

⁵Note that \mathbf{X} and \mathbf{Y} may not have equal number of projection operators. Therefore one of the sums may contain zeros as part of their summands.

then $\mathbf{T} = \sum_{k=1}^r (\lambda_k + i\lambda'_k) \mathbf{P}_k$. It follows that \mathbf{T} has a spectral decomposition, and therefore is diagonalizable. Theorem 6.4.18 now implies that \mathbf{X} and \mathbf{Y} must commute. Since, $\mathbf{X} = \frac{1}{2}(\mathbf{T} + \mathbf{T}^\dagger)$ and $\mathbf{Y} = \frac{1}{2i}(\mathbf{T} - \mathbf{T}^\dagger)$, we have $[\mathbf{X}, \mathbf{Y}] = \mathbf{0}$ if and only if $[\mathbf{T}, \mathbf{T}^\dagger] = \mathbf{0}$; i.e., \mathbf{T} is normal.

6.5 Functions of Operators

Functions of transformations were discussed in Chap. 4. With the power of spectral decomposition at our disposal, we can draw many important conclusions about them.

First, we note that if $\mathbf{T} = \sum_{i=1}^r \lambda_i \mathbf{P}_i$, then, because of orthogonality of the \mathbf{P}_i 's

$$\mathbf{T}^2 = \sum_{i=1}^r \lambda_i^2 \mathbf{P}_i, \quad \mathbf{T}^3 = \sum_{i=1}^r \lambda_i^3 \mathbf{P}_i, \quad \dots, \quad \mathbf{T}^n = \sum_{i=1}^r \lambda_i^n \mathbf{P}_i.$$

Thus, any polynomial p in \mathbf{T} has a spectral decomposition given by $p(\mathbf{T}) = \sum_{i=1}^r p(\lambda_i) \mathbf{P}_i$. Generalizing this to functions expandable in power series gives

$$f(\mathbf{T}) = \sum_{i=1}^{\infty} f(\lambda_i) \mathbf{P}_i. \quad (6.15)$$

Example 6.5.1 Let us investigate the spectral decomposition of the following unitary (actually orthogonal) matrix:

$$\mathbf{U} = \begin{pmatrix} \cos \theta & -\sin \theta \\ \sin \theta & \cos \theta \end{pmatrix}.$$

We find the eigenvalues

$$\det \begin{pmatrix} \cos \theta - \lambda & -\sin \theta \\ \sin \theta & \cos \theta - \lambda \end{pmatrix} = \lambda^2 - 2 \cos \theta \lambda + 1 = 0,$$

yielding $\lambda_1 = e^{-i\theta}$ and $\lambda_2 = e^{i\theta}$. For λ_1 we have (reader, provide the missing steps)

$$\begin{aligned} \begin{pmatrix} \cos \theta - e^{i\theta} & -\sin \theta \\ \sin \theta & \cos \theta - e^{i\theta} \end{pmatrix} \begin{pmatrix} \alpha_1 \\ \alpha_2 \end{pmatrix} &= 0 \\ \Rightarrow \alpha_2 = i\alpha_1 &\Rightarrow |e_1\rangle = \frac{1}{\sqrt{2}} \begin{pmatrix} 1 \\ i \end{pmatrix}, \end{aligned}$$

and for λ_2 ,

$$\begin{aligned} \begin{pmatrix} \cos \theta - e^{-i\theta} & -\sin \theta \\ \sin \theta & \cos \theta - e^{-i\theta} \end{pmatrix} \begin{pmatrix} \alpha_1 \\ \alpha_2 \end{pmatrix} &= 0 \\ \Rightarrow \alpha_2 = -i\alpha_1 &\Rightarrow |e_2\rangle = \frac{1}{\sqrt{2}} \begin{pmatrix} 1 \\ -i \end{pmatrix}. \end{aligned}$$

We note that the \mathcal{M}_{λ_j} are one-dimensional and spanned by $|e_j\rangle$. Thus,

$$P_1 = |e_1\rangle\langle e_1| = \frac{1}{2} \begin{pmatrix} 1 \\ i \end{pmatrix} \begin{pmatrix} 1 & -i \end{pmatrix} = \frac{1}{2} \begin{pmatrix} 1 & -i \\ i & 1 \end{pmatrix},$$

$$P_2 = |e_2\rangle\langle e_2| = \frac{1}{2} \begin{pmatrix} 1 \\ -i \end{pmatrix} \begin{pmatrix} 1 & i \end{pmatrix} = \frac{1}{2} \begin{pmatrix} 1 & i \\ -i & 1 \end{pmatrix}.$$

Clearly, $P_1 + P_2 = 1$, and

$$e^{-i\theta}P_1 + e^{i\theta}P_2 = \frac{1}{2} \begin{pmatrix} e^{-i\theta} & -ie^{-i\theta} \\ ie^{-i\theta} & e^{-i\theta} \end{pmatrix} + \frac{1}{2} \begin{pmatrix} e^{i\theta} & ie^{i\theta} \\ -ie^{i\theta} & e^{i\theta} \end{pmatrix} = U.$$

If we take the natural log of this equation and use Eq. (6.15), we obtain

$$\begin{aligned} \ln U &= \ln(e^{-i\theta})P_1 + \ln(e^{i\theta})P_2 = -i\theta P_1 + i\theta P_2 \\ &= i(-\theta P_1 + \theta P_2) \equiv iH, \end{aligned} \quad (6.16)$$

where $H \equiv -\theta P_1 + \theta P_2$ is a hermitian operator because θ is real and P_1 and P_2 are hermitian. Inverting Eq. (6.16) gives $U = e^{iH}$, where

$$H = \theta(-P_1 + P_2) = \theta \begin{pmatrix} 0 & i \\ -i & 0 \end{pmatrix}.$$

Using this matrix in the power series expansion of the exponential, the reader is urged to verify directly that $U = e^{iH}$.

The example above shows that the unitary 2×2 matrix U can be written as an exponential of an anti-hermitian operator. This is a general result. In fact, we have the following theorem, whose proof is left as an exercise for the reader (see Problem 6.23).

Theorem 6.5.2 *A unitary operator \mathbf{U} on a finite-dimensional complex inner product space can be written as $\mathbf{U} = e^{i\mathbf{H}}$ where \mathbf{H} is hermitian. Furthermore, a unitary matrix can be brought to diagonal form by a unitary transformation matrix.*

The last statement follows from Corollary 6.4.13 and the fact that

$$f(\mathbf{RHR}^{-1}) = \mathbf{R}f(\mathbf{H})\mathbf{R}^{-1}$$

for any function f that can be expanded in a Taylor series.

A useful function of an operator is its square root. A natural way to define the square root of a normal operator \mathbf{A} is $\sqrt{\mathbf{A}} = \sum_{i=1}^r (\pm\sqrt{\lambda_i})\mathbf{P}_i$. This clearly gives many candidates (2^r , to be exact) for the root.

Definition 6.5.3 The **positive square root** of a positive (thus hermitian, thus normal) operator $\mathbf{A} = \sum_{i=1}^r \lambda_i \mathbf{P}_i$ is $\sqrt{\mathbf{A}} = \sum_{i=1}^r \sqrt{\lambda_i} \mathbf{P}_i$.

The square root of a normal operator is plagued by multivaluedness. In the real numbers, we have only two-valuedness!

The uniqueness of the spectral decomposition implies that the positive square root of a positive operator is unique.

Example 6.5.4 Let us evaluate \sqrt{A} where

$$A = \begin{pmatrix} 5 & 3i \\ -3i & 5 \end{pmatrix}.$$

First, we have to spectrally decompose A . Its characteristic equation is

$$\lambda^2 - 10\lambda + 16 = 0,$$

with roots $\lambda_1 = 8$ and $\lambda_2 = 2$. Since both eigenvalues are positive and A is hermitian, we conclude that A is indeed positive (Corollary 6.4.10). We can also easily find its normalized eigenvectors:

$$|e_1\rangle = \frac{1}{\sqrt{2}} \begin{pmatrix} i \\ 1 \end{pmatrix} \quad \text{and} \quad |e_2\rangle = \frac{1}{\sqrt{2}} \begin{pmatrix} -i \\ 1 \end{pmatrix}.$$

Thus,

$$P_1 = |e_1\rangle\langle e_1| = \frac{1}{2} \begin{pmatrix} 1 & i \\ -i & 1 \end{pmatrix}, \quad P_2 = |e_2\rangle\langle e_2| = \frac{1}{2} \begin{pmatrix} 1 & -i \\ i & 1 \end{pmatrix},$$

and

$$\begin{aligned} \sqrt{A} &= \sqrt{\lambda_1}P_1 + \sqrt{\lambda_2}P_2 \\ &= \sqrt{8}\frac{1}{2} \begin{pmatrix} 1 & i \\ -i & 1 \end{pmatrix} + \sqrt{2}\frac{1}{2} \begin{pmatrix} 1 & -i \\ i & 1 \end{pmatrix} = \frac{1}{\sqrt{2}} \begin{pmatrix} 3 & i \\ -i & 3 \end{pmatrix}. \end{aligned}$$

We can easily check that $(\sqrt{A})^2 = A$.

Intuitively, higher and higher powers of \mathbf{T} , when acting on a few vectors of the space, eventually exhaust all vectors, and further increase in power will be a repetition of lower powers. This intuitive idea can be made more precise by looking at the projection operators. We have already seen that

$$\mathbf{T}^n = \sum_{j=1}^r \lambda_j^n \mathbf{P}_j, \quad n = 1, 2, \dots$$

For various n 's one can "solve" for \mathbf{P}_j in terms of powers of \mathbf{T} . Since there are only a finite number of \mathbf{P}_j 's, only a finite number of powers of \mathbf{T} will suffice. In fact, we can explicitly construct the polynomial in \mathbf{T} for \mathbf{P}_j . If there is such a polynomial, by Eq. (6.15) it must satisfy

$$\mathbf{P}_j = p_j(\mathbf{T}) = \sum_{k=1}^r p_j(\lambda_k) \mathbf{P}_k,$$

where p_j is some polynomial to be determined. By orthogonality of the projection operators, $p_j(\lambda_k)$ must be zero unless $k = j$, in which case it must be 1. In other words, $p_j(\lambda_k) = \delta_{kj}$. Such a polynomial can be explicitly

constructed:

$$p_j(x) = \left(\frac{x - \lambda_1}{\lambda_j - \lambda_1} \right) \left(\frac{x - \lambda_2}{\lambda_j - \lambda_2} \right) \cdots \left(\frac{x - \lambda_r}{\lambda_j - \lambda_r} \right) \equiv \prod_{k \neq j}^r \frac{x - \lambda_k}{\lambda_j - \lambda_k}.$$

Therefore,

$$\mathbf{P}_j = p_j(\mathbf{T}) \equiv \prod_{k \neq j}^r \frac{\mathbf{T} - \lambda_k \mathbf{1}}{\lambda_j - \lambda_k}, \quad (6.17)$$

and we have the following result.

Proposition 6.5.5 *Let \mathcal{V} be a finite-dimensional vector space and $\mathbf{T} \in \text{End}(\mathcal{V})$ a normal operator. Then*

$$f(\mathbf{T}) = \sum_{j=1}^r f(\lambda_j) \mathbf{P}_j = \sum_{j=1}^r f(\lambda_j) \prod_{k \neq j}^r \frac{\mathbf{T} - \lambda_k \mathbf{1}}{\lambda_j - \lambda_k}, \quad (6.18)$$

i.e., every function of \mathbf{T} is a polynomial.

Example 6.5.6 Let us write $\sqrt{\mathbf{A}}$ of the last example as a polynomial in \mathbf{A} . We have

$$p_1(\mathbf{A}) = \prod_{k \neq 1}^r \frac{\mathbf{A} - \lambda_k \mathbf{1}}{\lambda_1 - \lambda_k} = \frac{\mathbf{A} - \lambda_2 \mathbf{1}}{\lambda_1 - \lambda_2} = \frac{1}{6}(\mathbf{A} - 2),$$

$$p_2(\mathbf{A}) = \prod_{k \neq 2}^r \frac{\mathbf{A} - \lambda_k \mathbf{1}}{\lambda_2 - \lambda_k} = \frac{\mathbf{A} - \lambda_1 \mathbf{1}}{\lambda_2 - \lambda_1} = -\frac{1}{6}(\mathbf{A} - 8).$$

Substituting in Eq. (6.18), we obtain

$$\sqrt{\mathbf{A}} = \sqrt{\lambda_1} p_1(\mathbf{A}) + \sqrt{\lambda_2} p_2(\mathbf{A}) = \frac{\sqrt{8}}{6}(\mathbf{A} - 2) - \frac{\sqrt{2}}{6}(\mathbf{A} - 8) = \frac{\sqrt{2}}{6} \mathbf{A} + \frac{\sqrt{8}}{3} \mathbf{1}.$$

The RHS is clearly a (first-degree) polynomial in \mathbf{A} , and it is easy to verify that it is the matrix of $\sqrt{\mathbf{A}}$ obtained in the previous example.

6.6 Real Spectral Decomposition

The treatment so far in this chapter has focused on complex inner product spaces. The complex number system is “more complete” than the real numbers. For example, in preparation for the proof of the spectral decomposition theorem, we used the existence of roots of a polynomial over the complex field (this is the fundamental theorem of algebra). A polynomial over the reals, on the other hand, does not necessarily have all its roots in the real number system. Since the existence of roots was necessary for the proof of Theorem 6.3.2, real operators cannot, in general, even be represented by upper-triangular matrices. It may therefore seem that vector spaces over the

reals will not satisfy the useful theorems and results developed for complex spaces. However, as we shall see in this section, some of the useful results carry over to the real case.

Theorem 6.6.1 *An operator on a real vector space has invariant subspaces of dimension 1 or 2.*

Proof Let \mathcal{V} be a real vector space of dimension N and $\mathbf{T} \in \mathcal{L}(\mathcal{V})$. Take a nonzero vector $|v\rangle \in \mathcal{V}$ and consider the $N + 1$ vectors $\{\mathbf{T}^k|v\rangle\}_{k=0}^N$. These vectors are linearly dependent. Hence, there exist a set of real numbers $\{\eta_k\}_{k=0}^N$, not all equal to zero, such that

$$\eta_0|v\rangle + \eta_1\mathbf{T}|v\rangle + \cdots + \eta_N\mathbf{T}^N|v\rangle = |0\rangle \quad \text{or} \quad p(\mathbf{T})|v\rangle = |0\rangle, \quad (6.19)$$

where $p(\mathbf{T}) = \sum_{k=0}^N \eta_k \mathbf{T}^k$ is a polynomial in \mathbf{T} . By Theorem 3.6.5, we have

$$p(\mathbf{T}) = \gamma \prod_{i=1}^r (\mathbf{T} - \lambda_i \mathbf{1})^{k_i} \prod_{j=1}^R (\mathbf{T}^2 + \alpha_j \mathbf{T} + \beta_j \mathbf{1})^{K_j}, \quad (6.20)$$

for some nonzero constant γ .⁶ If all the factors in the two products are injective, then they are all invertible (why?). It follows that $p(\mathbf{T})$ is invertible, and Eq. (6.19) yields $|v\rangle = |0\rangle$, which contradicts our assumption. Hence, at least one of the factors in the product is not injective, i.e., its kernel contains a nonzero vector. If this factor is one of the terms in the first product, say $\mathbf{T} - \lambda_m \mathbf{1}$, and $|u\rangle \neq |0\rangle$ is in its kernel, then

$$(\mathbf{T} - \lambda_m \mathbf{1})|u\rangle = |0\rangle \quad \text{or} \quad \mathbf{T}|u\rangle = \lambda_m|u\rangle,$$

and $\text{Span}\{|u\rangle\}$ is a one-dimensional invariant subspace.

Now suppose that the non-injective factor is in the second product of Eq. (6.20), say $\mathbf{T}^2 + \alpha_n \mathbf{T} + \beta_n \mathbf{1}$ and $|v\rangle \neq |0\rangle$ is in its kernel, then

$$(\mathbf{T}^2 + \alpha_n \mathbf{T} + \beta_n \mathbf{1})|v\rangle = |0\rangle.$$

It is straightforward to show that $\text{Span}\{|v\rangle, \mathbf{T}|v\rangle\}$ is an invariant subspace, whose dimension is 1 if $|v\rangle$ happens to be an eigenvector of \mathbf{T} , and 2 if not. \square

Example 6.6.2 Consider the operator $\mathbf{T} : \mathbb{R}^2 \rightarrow \mathbb{R}^2$ given by

$$\mathbf{T} \begin{pmatrix} \alpha_1 \\ \alpha_2 \end{pmatrix} = \begin{pmatrix} \alpha_2 \\ -\alpha_1 \end{pmatrix}.$$

Suppose $|x\rangle \in \mathbb{R}^2$ is an eigenvector of \mathbf{T} . Then

$$\mathbf{T}|x\rangle = \lambda|x\rangle \quad \Rightarrow \quad \mathbf{T}^2|x\rangle = \lambda\mathbf{T}|x\rangle = \lambda^2|x\rangle.$$

But $\mathbf{T}^2 = -\mathbf{1}$, as can be easily verified. Therefore, $\lambda^2 = -1$, and \mathbf{T} has no real eigenvalue. It follows that \mathbf{T} has no eigenvectors in \mathbb{R}^2 .

⁶We are not assuming that $\eta_N \neq 0$.

The preceding example showed that there exist operators on \mathbb{R}^2 which have no eigenvectors. The fact that the dimension of the vector space was even played an important role in the absence of the eigenvectors. This is not generally true for odd-dimensional vector spaces. In fact, we have the following:

Theorem 6.6.3 *Every operator on an odd-dimensional real vector space has a real eigenvalue and an associated eigenvector.*

Proof Let \mathcal{V} be a real vector space of odd dimension N and $\mathbf{T} \in \mathcal{L}(\mathcal{V})$. We prove the theorem by induction on N . Obviously, the theorem holds for $N = 1$. If \mathbf{T} has no eigenvalue, then by Theorem 6.6.1, there is a two-dimensional invariant subspace \mathcal{U} . Write

$$\mathcal{V} = \mathcal{U} \oplus \mathcal{W},$$

where \mathcal{W} has odd dimension $N - 2$. With \mathbf{T}_U and \mathbf{T}_W as in Eq. (4.13), and the fact that $\mathbf{T}_W \in \mathcal{L}(\mathcal{W})$, we can assume that the induction hypothesis holds for \mathbf{T}_W , i.e., that it has a real eigenvalue λ and an eigenvector $|w\rangle$ in \mathcal{W} .

Now consider the 3-dimensional subspace \mathcal{V}_3 of \mathcal{V} and an operator \mathbf{T}_λ defined by

$$\mathcal{V}_3 = \mathcal{U} \oplus \text{Span}\{|w\rangle\}, \quad \text{and} \quad \mathbf{T}_\lambda = \mathbf{T} - \lambda \mathbf{1},$$

respectively, and note that $\mathbf{T}_\lambda \mathcal{U} \subseteq \mathcal{U}$ because \mathcal{U} is invariant under \mathbf{T} . Furthermore,

$$\begin{aligned} \mathbf{T}_\lambda |w\rangle &= \mathbf{T}|w\rangle - \lambda|w\rangle = \mathbf{T}_U |w\rangle + \underbrace{\mathbf{T}_W |w\rangle - \lambda|w\rangle}_{=|0\rangle} \\ &= \mathbf{T}_U |w\rangle = \mathbf{P}_U(\mathbf{T}_U |w\rangle) \in \mathcal{U}. \end{aligned}$$

Thus, $\mathbf{T}_\lambda : \mathcal{V}_3 \rightarrow \mathcal{U}$. Invoking the dimension theorem, we see that $\ker \mathbf{T}_\lambda$ has dimension at least one. Thus, there is $|v_3\rangle \in \mathcal{V}_3$ such that

$$\mathbf{T}_\lambda |v_3\rangle \equiv (\mathbf{T} - \lambda \mathbf{1})|v_3\rangle = |0\rangle,$$

i.e., that \mathbf{T} has a real eigenvalue and a corresponding eigenvector. \square

6.6.1 The Case of Symmetric Operators

The existence of at least one eigenvalue was crucial in proving the complex spectral theorem. A normal operator on a real vector space does not have a real eigenvalue in general. However, if the operator is self-adjoint (hermitian, symmetric), then it will have a real eigenvalue. To establish this, we start with the following

Lemma 6.6.4 *Let \mathbf{T} be a self-adjoint (hermitian) operator on a vector space \mathcal{V} . Then*

$$\mathbf{H} \equiv \mathbf{T}^2 + \alpha \mathbf{T} + \beta \mathbf{1}, \quad \alpha, \beta \in \mathbb{R}, \quad \alpha^2 < 4\beta,$$

is invertible.

Proof By Theorem 4.3.10, it is sufficient to prove that \mathbf{H} is strictly positive. Factor out the polynomial into its linear factors and note that, since α and β are real, the two roots are complex conjugate of one another. Furthermore, since $\alpha^2 < 4\beta$, the imaginary parts of the roots are not zero. Let λ be one of the roots and let $\mathbf{S} = \mathbf{T} - \lambda\mathbf{1}$. Since \mathbf{T} is self-adjoint, $\mathbf{H} = \mathbf{S}^\dagger\mathbf{S}$. Therefore,

$$\langle a|\mathbf{H}|a\rangle = \langle a|\mathbf{S}^\dagger\mathbf{S}|a\rangle = \langle \mathbf{S}a|\mathbf{S}a\rangle \geq 0.$$

The case of 0 is excluded because it corresponds to

$$\mathbf{S}|a\rangle = |0\rangle \quad \text{or} \quad (\mathbf{T} - \lambda\mathbf{1})|a\rangle = |0\rangle,$$

implying that $|a\rangle$ is an eigenvector of \mathbf{T} with a non-real eigenvalue. This contradicts Theorem 4.3.7. Therefore, $\langle a|\mathbf{H}|a\rangle > 0$. \square

Note that the lemma holds for complex as well as real vector spaces. Problem 6.24 shows how to prove the lemma without resort to complex roots.

Proposition 6.6.5 *A self-adjoint (symmetric) real operator has a real eigenvalue.*

Proof As in the proof of Theorem 6.6.1, we have a nonzero vector $|v\rangle$ and a polynomial $p(\mathbf{T})$ such that $p(\mathbf{T})|v\rangle = |0\rangle$, i.e.,

$$\prod_{i=1}^r (\mathbf{T} - \lambda_i\mathbf{1})^{k_i} \prod_{j=1}^R (\mathbf{T}^2 + \alpha_j\mathbf{T} + \beta_j\mathbf{1})^{K_j} |v\rangle = |0\rangle,$$

with $\lambda_i, \alpha_j, \beta_j \in \mathbb{R}$ and $\alpha_j^2 < 4\beta_j$. By Lemma 6.6.4, all the quadratic factors are invertible. Multiplying by their inverses, we get

$$\prod_{i=1}^r (\mathbf{T} - \lambda_i\mathbf{1})^{k_i} |v\rangle = |0\rangle.$$

At least one of these factors, say $i = m$, must be non-injective (why?). Hence,

$$(\mathbf{T} - \lambda_m\mathbf{1})^{k_m} |v\rangle = |0\rangle.$$

If $|a\rangle \equiv (\mathbf{T} - \lambda_m\mathbf{1})^{k_m-1} |v\rangle \neq |0\rangle$, then $|a\rangle$ is an eigenvector of \mathbf{T} with real eigenvalue λ_m . Otherwise, we have

$$(\mathbf{T} - \lambda_m\mathbf{1})^{k_m-1} |v\rangle = |0\rangle.$$

If $|b\rangle \equiv (\mathbf{T} - \lambda_m\mathbf{1})^{k_m-2} |v\rangle \neq |0\rangle$, then $|b\rangle$ is an eigenvector of \mathbf{T} with real eigenvalue λ_m . It is clear that this process has to stop at some point. It follows that there exists a nonzero vector $|c\rangle$ such that $(\mathbf{T} - \lambda_m\mathbf{1})|c\rangle = |0\rangle$. \square

Now that we have established the existence of at least one real eigenvalue for a self-adjoint real operator, we can follow the same steps taken in the proof of Theorem 6.4.8 and prove the following:

Theorem 6.6.6 Let \mathcal{V} be a real inner product space and \mathbf{T} a self-adjoint operator on \mathcal{V} . Then there exists an orthonormal basis in \mathcal{V} with respect to which \mathbf{T} is represented by a diagonal matrix.

This theorem is especially useful in applications of classical physics, which deal mostly with real vector spaces. A typical situation involves a vector that is related to another vector by a symmetric matrix. It is then convenient to find a coordinate system in which the two vectors are related in a simple manner. This involves diagonalizing the symmetric matrix by a rotation (a real orthogonal matrix). Theorem 6.6.6 reassures us that such a diagonalization is possible.

Example 6.6.7 For a system of N point particles constituting a rigid body, the total angular momentum $\mathbf{L} = \sum_{i=1}^N m_i (\mathbf{r}_i \times \mathbf{v}_i)$ is related to the angular frequency via

$$\mathbf{L} = \sum_{i=1}^N m_i [\mathbf{r}_i \times (\boldsymbol{\omega} \times \mathbf{r}_i)] = \sum_{i=1}^N m_i [\boldsymbol{\omega} \mathbf{r}_i \cdot \mathbf{r}_i - \mathbf{r}_i (\mathbf{r}_i \cdot \boldsymbol{\omega})],$$

moment of inertia matrix

or

$$\begin{pmatrix} L_x \\ L_y \\ L_z \end{pmatrix} = \begin{pmatrix} I_{xx} & I_{xy} & I_{xz} \\ I_{yx} & I_{yy} & I_{yz} \\ I_{zx} & I_{zy} & I_{zz} \end{pmatrix} \begin{pmatrix} \omega_x \\ \omega_y \\ \omega_z \end{pmatrix},$$

where

$$\begin{aligned} I_{xx} &= \sum_{i=1}^N m_i (r_i^2 - x_i^2), & I_{yy} &= \sum_{i=1}^N m_i (r_i^2 - y_i^2), \\ I_{zz} &= \sum_{i=1}^N m_i (r_i^2 - z_i^2), & I_{xy} &= - \sum_{i=1}^N m_i x_i y_i, \\ I_{xz} &= - \sum_{i=1}^N m_i x_i z_i, & I_{yz} &= - \sum_{i=1}^N m_i y_i z_i, \end{aligned}$$

with $I_{xy} = I_{yx}$, $I_{xz} = I_{zx}$, and $I_{yz} = I_{zy}$.

The 3×3 matrix is denoted by \mathbf{I} and is called the *moment of inertia* matrix. It is symmetric, and Theorem 6.6.6 permits its diagonalization by an orthogonal transformation (the counterpart of a unitary transformation in a real vector space). But an orthogonal transformation in three dimensions is merely a rotation of coordinates.⁷ Thus, Theorem 6.6.6 says that it is always possible to choose coordinate systems in which the moment of inertia matrix is diagonal. In such a coordinate system we have $L_x = I_{xx}\omega_x$, $L_y = I_{yy}\omega_y$, and $L_z = I_{zz}\omega_z$, simplifying the equations considerably.

⁷This is not entirely true! There are orthogonal transformations that are composed of a rotation followed by a reflection about the origin. See Example 5.5.3.

Similarly, the kinetic energy of the rigid rotating body,

$$\begin{aligned} T &= \sum_{i=1}^N \frac{1}{2} m_i v_i^2 = \sum_{i=1}^N \frac{1}{2} m_i \mathbf{v}_i \cdot (\boldsymbol{\omega} \times \mathbf{r}_i) \\ &= \sum_{i=1}^N \frac{1}{2} m_i \boldsymbol{\omega} \cdot (\mathbf{r}_i \times \mathbf{v}_i) = \frac{1}{2} \boldsymbol{\omega} \cdot \mathbf{L} = \frac{1}{2} \omega^t I \boldsymbol{\omega}, \end{aligned}$$

which in general has off-diagonal terms involving I_{xy} and so forth, reduces to a simple form: $T = \frac{1}{2} I_{xx} \omega_x^2 + \frac{1}{2} I_{yy} \omega_y^2 + \frac{1}{2} I_{zz} \omega_z^2$.

Example 6.6.8 Another application of Theorem 6.6.6 is in the study of conic sections. The most general form of the equation of a conic section is

$$a_1 x^2 + a_2 y^2 + a_3 xy + a_4 x + a_5 y + a_6 = 0,$$

where a_1, \dots, a_6 are constants. If the coordinate axes coincide with the principal axes of the conic section, the xy term will be absent, and the equation of the conic section takes the familiar form. On geometrical grounds we have to be able to rotate xy -coordinates to coincide with the principal axes. We shall do this using the ideas discussed in this chapter.

First, we note that the general equation for a conic section can be written in matrix form as

$$\begin{pmatrix} x & y \end{pmatrix} \begin{pmatrix} a_1 & a_3/2 \\ a_3/2 & a_2 \end{pmatrix} \begin{pmatrix} x \\ y \end{pmatrix} + \begin{pmatrix} a_4 & a_5 \end{pmatrix} \begin{pmatrix} x \\ y \end{pmatrix} + a_6 = 0.$$

The 2×2 matrix is symmetric and can therefore be diagonalized by means of an orthogonal matrix \mathbf{R} . Then $\mathbf{R}^t \mathbf{R} = 1$, and we can write

$$\begin{pmatrix} x & y \end{pmatrix} \mathbf{R}^t \mathbf{R} \begin{pmatrix} a_1 & a_3/2 \\ a_3/2 & a_2 \end{pmatrix} \mathbf{R}^t \mathbf{R} \begin{pmatrix} x \\ y \end{pmatrix} + \begin{pmatrix} a_4 & a_5 \end{pmatrix} \mathbf{R}^t \mathbf{R} \begin{pmatrix} x \\ y \end{pmatrix} + a_6 = 0.$$

Let

$$\begin{aligned} \mathbf{R} \begin{pmatrix} x \\ y \end{pmatrix} &= \begin{pmatrix} x' \\ y' \end{pmatrix}, & \mathbf{R} \begin{pmatrix} a_1 & a_3/2 \\ a_3/2 & a_2 \end{pmatrix} \mathbf{R}^t &= \begin{pmatrix} a'_1 & 0 \\ 0 & a'_2 \end{pmatrix}, \\ \mathbf{R} \begin{pmatrix} a_4 \\ a_5 \end{pmatrix} &= \begin{pmatrix} a'_4 \\ a'_5 \end{pmatrix}. \end{aligned}$$

Then we get

$$\begin{pmatrix} x' & y' \end{pmatrix} \begin{pmatrix} a'_1 & 0 \\ 0 & a'_2 \end{pmatrix} \begin{pmatrix} x' \\ y' \end{pmatrix} + \begin{pmatrix} a'_4 & a'_5 \end{pmatrix} \begin{pmatrix} x' \\ y' \end{pmatrix} + a_6 = 0;$$

or

$$a'_1 x'^2 + a'_2 y'^2 + a'_4 x' + a'_5 y' + a_6 = 0.$$

The cross term has disappeared. The orthogonal matrix \mathbf{R} is simply a rotation. In fact, it rotates the original coordinate system to coincide with the principal axes of the conic section.

Example 6.6.9 In this example we investigate conditions under which a multivariable function has a maximum or a minimum.

A point $\mathbf{a} = (a_1, a_2, \dots, a_n) \in \mathbb{R}^n$ is a maximum (minimum) of a function

$$f(x_1, x_2, \dots, x_n) \equiv f(\mathbf{r})$$

if

$$\nabla f|_{x_i=a_i} = \left(\frac{\partial f}{\partial x_1}, \frac{\partial f}{\partial x_2}, \dots, \frac{\partial f}{\partial x_n} \right)_{x_i=a_i} = 0.$$

For small $x_i - a_i$, the difference $f(\mathbf{r}) - f(\mathbf{a})$ is negative (positive). To relate this difference to the topics of this section, write the Taylor expansion of the function around \mathbf{a} keeping terms up to the second order:

$$\begin{aligned} f(\mathbf{r}) &= f(\mathbf{a}) + \sum_{i=1}^n (x_i - a_i) \left(\frac{\partial f}{\partial x_i} \right)_{\mathbf{r}=\mathbf{a}} \\ &\quad + \frac{1}{2} \sum_{i,j}^n (x_i - a_i)(x_j - a_j) \left(\frac{\partial^2 f}{\partial x_i \partial x_j} \right)_{\mathbf{r}=\mathbf{a}} + \dots, \end{aligned}$$

or, constructing a column vector out of $\delta_i \equiv x_i - a_i$ and a *symmetric* matrix D_{ij} out of the second derivatives, we can write

$$f(\mathbf{r}) = f(\mathbf{a}) + \frac{1}{2} \sum_{i,j}^n \delta_i \delta_j D_{ij} + \dots \Rightarrow f(\mathbf{r}) - f(\mathbf{a}) = \frac{1}{2} \delta^t \mathbf{D} \delta + \dots$$

because the first derivatives vanish. For \mathbf{a} to be a minimum point of f , the RHS of the last equation must be positive for *arbitrary* δ . This means that \mathbf{D} must be a positive matrix.⁸ Thus, all its eigenvalues must be positive (Corollary 6.4.10). Similarly, we can show that for \mathbf{a} to be a maximum point of f , $-\mathbf{D}$ must be positive definite. This means that \mathbf{D} must have negative eigenvalues.

When we specialize the foregoing discussion to two dimensions, we obtain results that are familiar from calculus. For the function $f(x, y)$ to have a minimum, the eigenvalues of the matrix

$$\begin{pmatrix} f_{xx} & f_{xy} \\ f_{yx} & f_{yy} \end{pmatrix}$$

must be positive. The characteristic polynomial

$$\det \begin{pmatrix} f_{xx} - \lambda & f_{xy} \\ f_{yx} & f_{yy} - \lambda \end{pmatrix} = 0 \Rightarrow \lambda^2 - (f_{xx} + f_{yy})\lambda + f_{xx}f_{yy} - f_{xy}^2 = 0$$

yields two eigenvalues:

$$\lambda_1 = \frac{f_{xx} + f_{yy} + \sqrt{(f_{xx} - f_{yy})^2 + 4f_{xy}^2}}{2},$$

extrema of a
multivariable function

⁸Note that \mathbf{D} is already symmetric—the real analogue of hermitian.

$$\lambda_2 = \frac{f_{xx} + f_{yy} - \sqrt{(f_{xx} - f_{yy})^2 + 4f_{xy}^2}}{2}.$$

These eigenvalues will be both positive if

$$f_{xx} + f_{yy} > \sqrt{(f_{xx} - f_{yy})^2 + 4f_{xy}^2},$$

and both negative if

$$f_{xx} + f_{yy} < -\sqrt{(f_{xx} - f_{yy})^2 + 4f_{xy}^2}.$$

Squaring these inequalities and simplifying yields

$$f_{xx}f_{yy} > f_{xy}^2,$$

which shows that f_{xx} and f_{yy} must have *the same sign*. If they are both positive (negative), we have a minimum (maximum). This is the familiar condition for the attainment of extrema by a function of two variables.

6.6.2 The Case of Real Normal Operators

The establishment of spectral decomposition for symmetric (self-adjoint) operators and its diagonalization was fairly straightforward, requiring only the assurance that the operator had a real eigenvalue, i.e., a one-dimensional invariant subspace. The general case of a normal operator does not embody this assurance. Hence, we do not expect a full diagonalization. Nevertheless, we can explore the minimal invariant subspaces of a normal operator on a real vector space.

Let's start with Theorem 6.6.1 and first note that the one dimensional invariant subspaces of an operator \mathbf{T} consist of vectors belonging to the kernel of a polynomial of first degree in \mathbf{T} ; i.e., these subspaces consist of vectors $|u\rangle$ such that

$$p_\lambda(\mathbf{T})|u\rangle \equiv (\mathbf{T} - \lambda\mathbf{1})|u\rangle = |0\rangle. \quad (6.21)$$

Since $\mathbf{T}\mathbf{T}^\dagger = \mathbf{T}^\dagger\mathbf{T}$, a subspace labeled by λ is invariant under both \mathbf{T} and \mathbf{T}^\dagger .

Next we note that the same applies to two-dimensional case. The vectors $|v\rangle$ in the two-dimensional invariant subspaces satisfy

$$p_{\alpha,\beta}(\mathbf{T})|v\rangle \equiv (\mathbf{T}^2 + \alpha\mathbf{T} + \beta\mathbf{1})|v\rangle = |0\rangle. \quad (6.22)$$

Again because of the commutativity of \mathbf{T} and \mathbf{T}^\dagger , if $|v\rangle$ is in a subspace, so is $\mathbf{T}^\dagger|v\rangle$, and the subspace is invariant under both \mathbf{T} and \mathbf{T}^\dagger .

Denote the subspace consisting of all vectors $|u\rangle$ satisfying Eq. (6.21) by \mathcal{M}_λ , and the subspace consisting of all vectors $|v\rangle$ satisfying Eq. (6.22) by $\mathcal{M}_{\alpha,\beta}$. We have already seen that $\mathcal{M}_\lambda \cap \mathcal{M}_{\lambda'} = \{|0\rangle\}$ if $\lambda \neq \lambda'$. We further

assume that there is no overlap between \mathcal{M}_{λ} s and $\mathcal{M}_{\alpha,\beta}$ s, i.e., the latter contain no eigenvectors. Now we show the same for two different $\mathcal{M}_{\alpha,\beta}$ s. Let $|v\rangle \in \mathcal{M}_{\alpha,\beta} \cap \mathcal{M}_{\alpha',\beta'}$. Then

$$\begin{aligned}(\mathbf{T}^2 + \alpha\mathbf{T} + \beta\mathbf{1})|v\rangle &= |0\rangle \\ (\mathbf{T}^2 + \alpha'\mathbf{T} + \beta'\mathbf{1})|v\rangle &= |0\rangle.\end{aligned}$$

Subtract the two equations to get

$$[(\alpha - \alpha')\mathbf{T} + (\beta - \beta')\mathbf{1}]|v\rangle = |0\rangle.$$

If $\alpha \neq \alpha'$, then dividing by $\alpha - \alpha'$ leads to an eigenvalue equation implying that $|v\rangle$ must belong to one of the \mathcal{M}_{λ} s, which is a contradiction. Therefore, $\alpha = \alpha'$, and if $\beta \neq \beta'$, then $|v\rangle = |0\rangle$.

Now consider the subspace

$$\mathcal{M} = \left(\bigoplus_{i=1}^r \mathcal{M}_{\lambda_i} \right) \oplus \left(\bigoplus_{j=1}^s \mathcal{M}_{\alpha_j, \beta_j} \right),$$

where $\{\lambda_i\}_{i=1}^r$ exhausts all the distinct eigenvalues and $\{(\alpha_j, \beta_j)\}_{j=1}^s$ exhausts all the distinct pairs corresponding to Eq. (6.22). Both \mathbf{T} and \mathbf{T}^\dagger leave \mathcal{M} invariant. Therefore, \mathcal{M}^\perp is also invariant under \mathbf{T} . If $\mathcal{M}^\perp \neq \{|0\rangle\}$, then it can be considered as a vector space on its own, and \mathbf{T} can find either a one-dimensional or a two-dimensional invariant subspace. This contradicts the assumption that both of these are accounted for in the direct sums above. Hence, we have

Theorem 6.6.10 *Let \mathcal{V} be a real vector space and \mathbf{T} a normal operator on \mathcal{V} . Let $\{\lambda_i\}_{i=1}^r$ be complete set of the distinct eigenvalues of \mathbf{T} and $\{(\alpha_j, \beta_j)\}_{j=1}^s$ all the distinct pairs labeling the second degree polynomials of Eq. (6.22). Let $\mathcal{M}_{\lambda_i} = \ker p_{\lambda_i}(\mathbf{T})$ and $\mathcal{M}_{\alpha_j, \beta_j} = \ker p_{\alpha_j, \beta_j}(\mathbf{T})$ as in (6.21) and (6.22). Then*

$$\mathcal{V} = \left(\bigoplus_{i=1}^r \mathcal{M}_{\lambda_i} \right) \oplus \left(\bigoplus_{j=1}^s \mathcal{M}_{\alpha_j, \beta_j} \right),$$

where $\lambda_i, \alpha_j, \beta_j \in \mathbb{R}$ and $\alpha_j^2 < 4\beta_j$.

We now seek bases of \mathcal{V} with respect to which \mathbf{T} has as simple a representation as possible. Let m_i denote the dimension of \mathcal{M}_{λ_i} and $\{|a_k^{(i)}\}_{k=1}^{m_i}$ a basis of \mathcal{M}_{λ_i} . To construct a basis for $\mathcal{M}_{\alpha_j, \beta_j}$, let $|b_1^{(\alpha_j, \beta_j)}\rangle$ be a vector linearly independent from $|a_k^{(i)}\rangle$ for all i and k . Let $|b_2^{(\alpha_j, \beta_j)}\rangle = \mathbf{T}|b_1^{(\alpha_j, \beta_j)}\rangle$, and note that $|b_1^{(\alpha_j, \beta_j)}\rangle$ and $|b_2^{(\alpha_j, \beta_j)}\rangle$ are linearly independent from each other and all the $|a_k^{(i)}\rangle$ s (why?). Pick $|b_3^{(\alpha_j, \beta_j)}\rangle$ to be linearly independent from all the previously constructed vectors and let $|b_4^{(\alpha_j, \beta_j)}\rangle = \mathbf{T}|b_3^{(\alpha_j, \beta_j)}\rangle$. Continue

this process until a basis for $\mathcal{M}_{\alpha_j, \beta_j}$ is constructed. Do this for all j . If we denote the dimension of $\mathcal{M}_{\alpha_j, \beta_j}$ by n_j , then

$$B_V \equiv \left(\bigcup_{i=1}^r \{ |a_k^{(i)}\rangle \}_{k=1}^{m_i} \right) \cup \left(\bigcup_{j=1}^s \{ |b_k^{(\alpha_j, \beta_j)}\rangle \}_{k=1}^{n_j} \right)$$

is a basis for \mathcal{V} .

How does the matrix M_T of \mathbf{T} look like in this basis? We leave it to the reader to verify that

$$M_T = \text{diag}(\lambda_1 \mathbf{1}_{m_1}, \dots, \lambda_r \mathbf{1}_{m_r}, M_{\alpha_1, \beta_1}, \dots, M_{\alpha_s, \beta_s}), \quad (6.23)$$

where diag means a block diagonal matrix, $\mathbf{1}_k$ is a $k \times k$ identity matrix, and

$$M_{\alpha_j, \beta_j} = \text{diag}(J_1, \dots, J_{n_j}), \quad J_k = \begin{pmatrix} 0 & -\beta_j \\ 1 & -\alpha_j \end{pmatrix}, \quad k = 1, \dots, n_j. \quad (6.24)$$

In other words, M_T has the eigenvalues of \mathbf{T} on the main diagonal up to $m_1 + \dots + m_r$ and then 2×2 matrices similar to J_k (possibly with different α_j and β_j) for the rest of the diagonal positions.

Consider any eigenvector $|x_1\rangle$ of \mathbf{T} (if it exists). Obviously, $\text{Span}\{|x_1\rangle\}$ is a subspace of \mathcal{V} invariant under \mathbf{T} . By Theorem 6.4.3, $\text{Span}\{|x_1\rangle\}$ reduces \mathbf{T} . Thus, we can write

$$\mathcal{V} = \text{Span}\{|x_1\rangle\} \oplus \text{Span}\{|x_1\rangle\}^\perp.$$

Now pick a new eigenvector $|x_2\rangle$ in $\text{Span}\{|x_1\rangle\}^\perp$ (if it exists) and write

$$\mathcal{V} = \text{Span}\{|x_1\rangle\} \oplus \text{Span}\{|x_2\rangle\} \oplus \text{Span}\{|x_2\rangle\}^\perp.$$

Continue this until all the eigenvectors are exhausted (there may be none). Then, we have

$$\begin{aligned} \mathcal{V} &= \left(\bigoplus_{i=1}^M \text{Span}\{|x_i\rangle\} \right) \oplus \left(\bigoplus_{i=1}^M \text{Span}\{|x_i\rangle\} \right)^\perp \\ &\equiv \left(\bigoplus_{i=1}^M \text{Span}\{|x_i\rangle\} \right) \oplus \mathcal{W}. \end{aligned}$$

Since a real vector space has minimal invariant subspaces of dimensions one and two, \mathcal{W} contains only two-dimensional subspaces (if any). Let $|y_1\rangle$ be a nonzero vector in \mathcal{W} . Then there is a second degree polynomial of the type given in Eq. (6.22) whose kernel is the two-dimensional subspace $\text{Span}\{|y_1\rangle, \mathbf{T}|y_1\rangle\}$ of \mathcal{W} . This subspace is invariant under \mathbf{T} , and by Theorem 6.4.3, it reduces \mathbf{T} in \mathcal{W} . Thus,

$$\mathcal{W} = \text{Span}\{|y_1\rangle, \mathbf{T}|y_1\rangle\} \oplus \text{Span}\{|y_1\rangle, \mathbf{T}|y_1\rangle\}^\perp.$$

Continuing this process and noting that \mathcal{W} does not contain any one-dimensional invariant subspace, we obtain

$$\mathcal{W} = \bigoplus_{j=1}^K \text{Span}\{|y_j\rangle, \mathbf{T}|y_j\rangle\}$$

and hence,

Theorem 6.6.11 (Real Spectral Decomposition) *Let \mathcal{V} be a real vector space and \mathbf{T} a normal operator on \mathcal{V} . Let $|x_i\rangle$ and $|y_j\rangle$ satisfy Eqs. (6.21) and (6.22), respectively. Then,*

$$\mathcal{V} = \left(\bigoplus_{i=1}^M \text{Span}\{|x_i\rangle\} \right) \oplus \left(\bigoplus_{j=1}^K \text{Span}\{|y_j\rangle, \mathbf{T}|y_j\rangle\} \right) \quad (6.25)$$

with $\dim \mathcal{V} = 2K + M$.

Real Spectral
Decomposition Theorem

We have thus written \mathcal{V} as a direct sum of one- and two-dimensional subspaces. Either K (e.g., in the case of a real self-adjoint operator) or M (e.g., in the case of the operator of Example 6.5.1) could be zero.

An important application of Theorem 6.6.11 is the spectral decomposition of an orthogonal (isometric) operator. This operator has the property that $\mathbf{O}\mathbf{O}^t = \mathbf{1}$. Taking the determinants of both sides, we obtain $(\det \mathbf{O})^2 = 1$. Using Theorem 6.6.11 (or 6.6.10), we see that the representation of \mathbf{O} consists of some 1×1 and some 2×2 matrices placed along the diagonal. Furthermore, these matrices are orthogonal (why?). Since the eigenvalues of an orthogonal operator have absolute value 1 (this is the real version of the second part of Corollary 6.4.5), a 1×1 orthogonal matrix can be only ± 1 . An orthogonal 2×2 matrix is of the forms given in Problem 5.9, i.e.,

$$\mathbf{R}_2(\theta_j) \equiv \begin{pmatrix} \cos \theta_j & -\sin \theta_j \\ \sin \theta_j & \cos \theta_j \end{pmatrix} \quad \text{or} \quad \begin{pmatrix} \cos \theta_j & \sin \theta_j \\ \sin \theta_j & -\cos \theta_j \end{pmatrix}, \quad (6.26)$$

in which the first has a determinant $+1$ and the second -1 . We thus have the following:

Theorem 6.6.12 *A real orthogonal operator on a real inner product space \mathcal{V} cannot, in general, be completely diagonalized. The closest it can get to a diagonal form is*

$$\mathbf{O}_{\text{diag}} = \text{diag}\left(\underbrace{1, 1, \dots, 1}_{N_+}, \underbrace{-1, -1, \dots, -1}_{N_-}, \mathbf{R}_2(\theta_1), \mathbf{R}_2(\theta_2), \dots, \mathbf{R}_2(\theta_m)\right),$$

where $N_+ + N_- + 2m = \dim \mathcal{V}$ and $\mathbf{R}_2(\theta_j)$ is as given in (6.26). Furthermore, the matrix that transforms an orthogonal matrix into the form above is itself an orthogonal matrix.

The last statement follows from Theorem 6.5.2 and the fact that an orthogonal matrix is the real analogue of a unitary matrix.

Example 6.6.13 In this example, we illustrate an intuitive (and non-rigorous) “proof” of the diagonalization of an orthonormal operator, which in some sense involves the complexification of a real vector space.

Think of the orthogonal operator \mathbf{O} as a unitary operator.⁹ Since the absolute value of the eigenvalues of a unitary operator is 1, the only real possibilities are ± 1 . To find the other eigenvalues we note that as a unitary operator, \mathbf{O} can be written as $e^{\mathbf{A}}$, where \mathbf{A} is anti-hermitian (see Problem 6.23). Since hermitian conjugation and transposition coincide for real vector spaces, we conclude that $\mathbf{A} = -\mathbf{A}^t$, and \mathbf{A} is antisymmetric. It is also real, because \mathbf{O} is.

Let us now consider the eigenvalues of \mathbf{A} . If λ is an eigenvalue of \mathbf{A} corresponding to the eigenvector $|a\rangle$, then $\langle a|\mathbf{A}|a\rangle = \lambda\langle a|a\rangle$. Taking the complex conjugate of both sides gives $\langle a|\mathbf{A}^\dagger|a\rangle = \lambda^*\langle a|a\rangle$; but $\mathbf{A}^\dagger = \mathbf{A}^t = -\mathbf{A}$, because \mathbf{A} is real and antisymmetric. We therefore have $\langle a|\mathbf{A}|a\rangle = -\lambda^*\langle a|a\rangle$, which gives $\lambda^* = -\lambda$. It follows that if we restrict λ to be real, then it can only be zero; otherwise, it must be *purely imaginary*. Furthermore, the reader may verify that if λ is an eigenvalue of \mathbf{A} , so is $-\lambda$. Therefore, the diagonal form of \mathbf{A} looks like this:

$$\mathbf{A}_{\text{diag}} = \text{diag}(0, 0, \dots, 0, i\theta_1, -i\theta_1, i\theta_2, -i\theta_2, \dots, i\theta_k, -i\theta_k),$$

which gives \mathbf{O} the following diagonal form:

$$\mathbf{O}_{\text{diag}} = e^{\mathbf{A}_{\text{diag}}} = \text{diag}(e^0, e^0, \dots, e^0, e^{i\theta_1}, e^{-i\theta_1}, e^{i\theta_2}, e^{-i\theta_2}, \dots, e^{i\theta_k}, e^{-i\theta_k})$$

with $\theta_1, \theta_2, \dots, \theta_k$ all real. It is clear that if \mathbf{O} has -1 as an eigenvalue, then some of the θ 's must equal $\pm\pi$. Separating the π 's from the rest of θ 's and putting all of the above arguments together, we get

$$\mathbf{O}_{\text{diag}} = \text{diag}\left(\underbrace{1, 1, \dots, 1}_{N_+}, \underbrace{-1, -1, \dots, -1}_{N_-}, e^{i\theta_1}, e^{-i\theta_1}, e^{i\theta_2}, e^{-i\theta_2}, \dots, e^{i\theta_m}, e^{-i\theta_m}\right)$$

where $N_+ + N_- + 2m = \dim \mathbf{O}$.

Getting insight from Example 6.5.1, we can argue, admittedly in a non-rigorous way, that corresponding to each pair $e^{\pm i\theta_j}$ is a 2×2 matrix of the form given in Eq. (6.26).

We can add more rigor to the preceding example by the process of complexification and the notion of a complex structure. Recall from Eq. (2.22) that a real $2m$ -dimensional vector space can be reduced to an m -dimensional complex space. Now consider the restriction of the orthogonal operator \mathbf{O} on the $2K$ -dimensional vector subspace \mathcal{W} of Eq. (6.25), and let \mathbf{J} be a

⁹This can always be done by formally identifying transposition with hermitian conjugation, an identification that holds when the underlying field of numbers is real.

complex structure on that subspace. Let $\{|f_i\rangle, \mathbf{J}|f_i\rangle\}_{i=1}^K$ be an orthonormal basis of \mathcal{W} and $\mathcal{W}_1^{\mathbb{C}}$, the complexification of $\mathcal{W}_1 \equiv \text{Span}\{|f_i\rangle\}_{i=1}^K$. Define the unitary operator \mathbf{U} on \mathcal{W}_1 by

$$\mathbf{U}|f_j\rangle = \mathbf{O}|f_j\rangle,$$

and extend it by linearity and Eq. (2.22), which requires that \mathbf{O} and \mathbf{J} commute. This replaces the *orthogonal* operator \mathbf{O} on the $2K$ -dimensional vector space \mathcal{W} with a *unitary* operator \mathbf{U} on the K -dimensional vector space \mathcal{W}_1 . Thus, we can apply the *complex* spectral decomposition and replace the $|f_i\rangle$ with $|e_i\rangle$, the eigenvectors of \mathbf{U} .

We now find the matrix representation of \mathbf{O} in this new orthonormal basis from that of \mathbf{U} . For $j = 1, \dots, K$, we have

$$\begin{aligned} \mathbf{O}|e_j\rangle &= \mathbf{U}|e_j\rangle = e^{i\theta_j}|e_j\rangle = (\cos\theta_j + i\sin\theta_j)|e_j\rangle \\ &= (\cos\theta_j\mathbf{1} + \sin\theta_j\mathbf{J})|e_j\rangle = \cos\theta_j|e_j\rangle + \sin\theta_j|e_{j+1}\rangle \\ \mathbf{O}|e_{j+1}\rangle &= \mathbf{O}\mathbf{J}|e_j\rangle = \mathbf{J}\mathbf{O}|e_j\rangle = i\mathbf{U}|e_j\rangle = ie^{i\theta_j}|e_j\rangle \\ &= (i\cos\theta_j - \sin\theta_j)|e_j\rangle = (\cos\theta_j\mathbf{J} - \sin\theta_j\mathbf{1})|e_j\rangle \\ &= -\sin\theta_j|e_j\rangle + \cos\theta_j|e_{j+1}\rangle. \end{aligned}$$

Thus the j th and $j + 1$ st columns will be of the form

$$\begin{pmatrix} 0 & 0 \\ \vdots & \vdots \\ 0 & 0 \\ \cos\theta_j & -\sin\theta_j \\ \sin\theta_j & \cos\theta_j \\ 0 & 0 \\ \vdots & \vdots \\ 0 & 0 \end{pmatrix}.$$

Putting all the columns together reproduces the result of Theorem 6.6.12.

Example 6.6.14 An interesting application of Theorem 6.6.12 occurs in classical mechanics, where it is shown that the motion of a rigid body consists of a translation and a rotation. The rotation is represented by a 3×3 orthogonal matrix. Theorem 6.6.12 states that by an appropriate choice of coordinate systems (i.e., by applying the same orthogonal transformation that diagonalizes the rotation matrix of the rigid body), one can “diagonalize” the 3×3 orthogonal matrix. The “diagonal” form is

$$\begin{pmatrix} \pm 1 & 0 & 0 \\ 0 & \pm 1 & 0 \\ 0 & 0 & \pm 1 \end{pmatrix} \quad \text{or} \quad \begin{pmatrix} \pm 1 & 0 & 0 \\ 0 & \cos\theta & -\sin\theta \\ 0 & \sin\theta & \cos\theta \end{pmatrix}.$$

Excluding the reflections (corresponding to -1 's) and the trivial identity rotation, we conclude that any rotation of a rigid body can be written as

$$\begin{pmatrix} 1 & 0 & 0 \\ 0 & \cos \theta & -\sin \theta \\ 0 & \sin \theta & \cos \theta \end{pmatrix},$$

which is a rotation through the angle θ about the (new) x -axis.

Combining the rotation of the example above with the translations, we obtain the following theorem.

Euler Theorem **Theorem 6.6.15** (Euler) *The general motion of a rigid body consists of the translation of one point of that body and a rotation about a single axis through that point.*

Example 6.6.16 As a final example of the application of the results of this section, let us evaluate the n -fold integral

$$I_n = \int_{-\infty}^{\infty} dx_1 \int_{-\infty}^{\infty} dx_2 \dots \int_{-\infty}^{\infty} dx_n e^{-\sum_{i,j=1}^n m_{ij} x_i x_j}, \quad (6.27)$$

where the m_{ij} are elements of a real, symmetric, positive definite matrix, say M . Because it is symmetric, M can be diagonalized by an orthogonal matrix R so that $RMR^t = D$ is a diagonal matrix whose diagonal entries are the eigenvalues, $\lambda_1, \lambda_2, \dots, \lambda_n$, of M , whose positive definiteness ensures that none of these eigenvalues is zero or negative.

The exponent in (6.27) can be written as

$$\sum_{i,j=1}^n m_{ij} x_i x_j = \mathbf{x}^t M \mathbf{x} = \mathbf{x}^t R^t R M R^t R \mathbf{x} = \mathbf{x}'^t D \mathbf{x}' = \lambda_1 x_1'^2 + \dots + \lambda_n x_n'^2,$$

where

$$\mathbf{x}' = \begin{pmatrix} x_1' \\ x_2' \\ \vdots \\ x_n' \end{pmatrix} = R \mathbf{x} = R \begin{pmatrix} x_1 \\ x_2 \\ \vdots \\ x_n \end{pmatrix},$$

or, in component form, $x_i' = \sum_{j=1}^n r_{ij} x_j$ for $i = 1, 2, \dots, n$. Similarly, since $\mathbf{x} = R^t \mathbf{x}'$, it follows that $x_i = \sum_{j=1}^n r_{ji} x_j'$ for $i = 1, 2, \dots, n$.

The “volume element” $dx_1 \dots dx_n$ is related to the primed volume element as follows:

$$dx_1 \dots dx_n = \left| \frac{\partial(x_1, x_2, \dots, x_n)}{\partial(x_1', x_2', \dots, x_n')} \right| dx_1' \dots dx_n' \equiv |\det J| dx_1' \dots dx_n',$$

where J is the Jacobian *matrix* whose ij th element is $\partial x_i / \partial x_j'$. But

$$\frac{\partial x_i}{\partial x_j'} = r_{ji} \Rightarrow J = R^t \Rightarrow |\det J| = |\det R^t| = 1.$$

Therefore, in terms of x' , the integral I_n becomes

$$\begin{aligned} I_n &= \int_{-\infty}^{\infty} dx'_1 \int_{-\infty}^{\infty} dx'_2 \cdots \int_{-\infty}^{\infty} dx'_n e^{-\lambda_1 x_1'^2 - \lambda_2 x_2'^2 - \cdots - \lambda_n x_n'^2} \\ &= \left(\int_{-\infty}^{\infty} dx'_1 e^{-\lambda_1 x_1'^2} \right) \left(\int_{-\infty}^{\infty} dx'_2 e^{-\lambda_2 x_2'^2} \right) \cdots \left(\int_{-\infty}^{\infty} dx'_n e^{-\lambda_n x_n'^2} \right) \\ &= \sqrt{\frac{\pi}{\lambda_1}} \sqrt{\frac{\pi}{\lambda_2}} \cdots \sqrt{\frac{\pi}{\lambda_n}} = \pi^{n/2} \frac{1}{\sqrt{\lambda_1 \lambda_2 \cdots \lambda_n}} = \pi^{n/2} (\det \mathbf{M})^{-1/2}, \end{aligned}$$

because the determinant of a matrix is the product of its eigenvalues. This result can be written as

$$\int_{-\infty}^{\infty} d^n x e^{-x' \mathbf{M} x} = \pi^{n/2} (\det \mathbf{M})^{-1/2},$$

which gives an *analytic* definition of the determinant.

analytic definition of the determinant of a matrix

Proposition 6.6.17 *The determinant of a positive definite matrix \mathbf{M} is given by*

$$\det \mathbf{M} = \frac{\pi^n}{\left(\int_{-\infty}^{\infty} d^n x e^{-x' \mathbf{M} x} \right)^2}.$$

6.7 Polar Decomposition

We have seen many similarities between operators and complex numbers. For instance, hermitian operators behave very much like the real numbers: they have real eigenvalues; their squares are positive; every operator can be written as $\mathbf{X} + i\mathbf{Y}$, where both \mathbf{X} and \mathbf{Y} are hermitian; and so forth. Also, unitary operators can be written as $\exp(i\mathbf{H})$, where \mathbf{H} is hermitian. So unitary operators are the analogue of complex numbers of unit magnitude such as $e^{i\theta}$.

A general complex number z can be written as $re^{i\theta}$, where $r = \sqrt{z^* z}$. Can we write an arbitrary operator \mathbf{T} in an analogous way? Perhaps as $\sqrt{\mathbf{T}^\dagger \mathbf{T}} \exp(i\mathbf{H})$, with \mathbf{H} hermitian? The following theorem provides the answer.

Theorem 6.7.1 (Polar Decomposition) *An operator \mathbf{T} on a (real or complex) finite-dimensional inner product space can be written as $\mathbf{T} = \mathbf{U}\mathbf{R}$ where \mathbf{R} is a positive operator and \mathbf{U} an isometry (a unitary or orthogonal operator).*

polar decomposition theorem

Proof With insight from the complex number theory, let $\mathbf{R} = \sqrt{\mathbf{T}^\dagger \mathbf{T}}$, where the right-hand side is understood as the positive square root. Now note that

$$\langle \mathbf{T}a | \mathbf{T}a \rangle = \langle a | \mathbf{T}^\dagger \mathbf{T} a \rangle = \langle a | \mathbf{R}^2 a \rangle = \langle a | \mathbf{R}^\dagger \mathbf{R} a \rangle = \langle \mathbf{R}a | \mathbf{R}a \rangle$$

because \mathbf{R} is positive, and therefore self-adjoint. This shows that $\mathbf{T}|a\rangle$ and $\mathbf{R}|a\rangle$ are connected by an isometry. Since $\mathbf{T}|a\rangle$ and $\mathbf{R}|a\rangle$ belong to the ranges of the two operators, this isometry can be defined only on those ranges.

Define the linear (reader, verify!) isometry $\mathbf{U} : \mathbf{R}(\mathcal{V}) \rightarrow \mathbf{T}(\mathcal{V})$ by $\mathbf{U}\mathbf{R}|x\rangle = \mathbf{T}|x\rangle$ for $|x\rangle \in \mathcal{V}$, and note that by its very definition, \mathbf{U} is surjective. First we have to make sure that \mathbf{U} is well defined, i.e., it does not map the same vector onto two different vectors. This is a legitimate concern, because \mathbf{R} may not be injective, and two different vectors of \mathcal{V} may be mapped by \mathbf{R} onto the same vector. So, assume that $\mathbf{R}|a_1\rangle = \mathbf{R}|a_2\rangle$. Then

$$\mathbf{U}\mathbf{R}|a_1\rangle = \mathbf{U}\mathbf{R}|a_2\rangle \Rightarrow \mathbf{T}|a_1\rangle = \mathbf{T}|a_2\rangle.$$

Hence, \mathbf{U} is well defined.

Next note that any linear isometry is injective (Theorem 2.3.12). Therefore, \mathbf{U} is invertible and $\mathbf{R}(\mathcal{V})^\perp \cong \mathbf{T}(\mathcal{V})^\perp$. To complete the proof, let $\{|e_i\rangle\}_{i=1}^m$ be an orthonormal basis of $\mathbf{R}(\mathcal{V})^\perp$ and $\{|f_i\rangle\}_{i=1}^m$ an orthonormal basis of $\mathbf{T}(\mathcal{V})^\perp$ and extend \mathbf{U} by setting $\mathbf{U}|e_i\rangle = |f_i\rangle$. \square

We note that if \mathbf{T} is injective, then \mathbf{R} is invertible, and therefore, unique. However, \mathbf{U} is not unique, because for any isometry $\mathbf{S} : \mathbf{T}(\mathcal{V}) \rightarrow \mathbf{T}(\mathcal{V})$, the operator $\mathbf{S} \circ \mathbf{U}$ works just as well in the proof.

It is interesting to note that the positivity of \mathbf{R} and the nonuniqueness of \mathbf{U} are the analogue of the positivity of r and the nonuniqueness of $e^{i\theta}$ in the polar representation of complex numbers:

$$z = re^{i\theta} = re^{i(\theta+2n\pi)} \quad \forall n \in \mathbb{Z}.$$

In practice, \mathbf{R} is found by spectrally decomposing $\mathbf{T}^\dagger\mathbf{T}$ and taking its positive square root.¹⁰ Once \mathbf{R} is found, \mathbf{U} can be calculated from the definition $\mathbf{T} = \mathbf{U}\mathbf{R}$. This last step is especially simple if \mathbf{T} is injective.

Example 6.7.2 Let us find the polar decomposition of

$$\mathbf{A} = \begin{pmatrix} -2i & \sqrt{7} \\ 0 & 3 \end{pmatrix}.$$

We have

$$\mathbf{R}^2 = \mathbf{A}^\dagger\mathbf{A} = \begin{pmatrix} 2i & 0 \\ \sqrt{7} & 3 \end{pmatrix} \begin{pmatrix} -2i & \sqrt{7} \\ 0 & 3 \end{pmatrix} = \begin{pmatrix} 4 & 2i\sqrt{7} \\ -2i\sqrt{7} & 16 \end{pmatrix}.$$

The eigenvalues and eigenvectors of \mathbf{R}^2 are routinely found to be

$$\lambda_1 = 18, \quad \lambda_2 = 2, \quad |e_1\rangle = \frac{1}{2\sqrt{2}} \begin{pmatrix} i \\ \sqrt{7} \end{pmatrix}, \quad |e_2\rangle = \frac{1}{2\sqrt{2}} \begin{pmatrix} \sqrt{7} \\ i \end{pmatrix}.$$

¹⁰It is important to pay attention to the order of the two operators: One decomposes $\mathbf{T}^\dagger\mathbf{T}$, not $\mathbf{T}\mathbf{T}^\dagger$.

The projection matrices are

$$P_1 = |e_1\rangle\langle e_1| = \frac{1}{8} \begin{pmatrix} 1 & i\sqrt{7} \\ -i\sqrt{7} & 7 \end{pmatrix},$$

$$P_2 = |e_2\rangle\langle e_2| = \frac{1}{8} \begin{pmatrix} 7 & -i\sqrt{7} \\ i\sqrt{7} & 1 \end{pmatrix}.$$

Thus,

$$R = \sqrt{\lambda_1}P_1 + \sqrt{\lambda_2}P_2 = \frac{1}{4} \begin{pmatrix} 5\sqrt{2} & i\sqrt{14} \\ -i\sqrt{14} & 11\sqrt{2} \end{pmatrix}.$$

To find U , we note that $\det A$ is nonzero. Hence, A is invertible, which implies that R is also invertible. The inverse of R is

$$R^{-1} = \frac{1}{24} \begin{pmatrix} 11\sqrt{2} & -i\sqrt{14} \\ i\sqrt{14} & 5\sqrt{2} \end{pmatrix}.$$

The unitary matrix is simply

$$U = AR^{-1} = \frac{1}{24} \begin{pmatrix} -i15\sqrt{2} & 3\sqrt{14} \\ 3i\sqrt{14} & 15\sqrt{2} \end{pmatrix}.$$

It is left for the reader to verify that U is indeed unitary.

Example 6.7.3 Let us decompose the following real matrix into its polar form:

$$A = \begin{pmatrix} 2 & 0 \\ 3 & -2 \end{pmatrix}.$$

The procedure is the same as in the complex case. We have

$$R^2 = A^t A = \begin{pmatrix} 2 & 3 \\ 0 & -2 \end{pmatrix} \begin{pmatrix} 2 & 0 \\ 3 & -2 \end{pmatrix} = \begin{pmatrix} 13 & -6 \\ -6 & 4 \end{pmatrix}$$

with eigenvalues $\lambda_1 = 1$ and $\lambda_2 = 16$ and normalized eigenvectors

$$|e_1\rangle = \frac{1}{\sqrt{5}} \begin{pmatrix} 1 \\ 2 \end{pmatrix} \quad \text{and} \quad |e_2\rangle = \frac{1}{\sqrt{5}} \begin{pmatrix} 2 \\ -1 \end{pmatrix}.$$

The projection operators are

$$P_1 = |e_1\rangle\langle e_1| = \frac{1}{5} \begin{pmatrix} 1 & 2 \\ 2 & 4 \end{pmatrix}, \quad P_2 = |e_2\rangle\langle e_2| = \frac{1}{5} \begin{pmatrix} 4 & -2 \\ -2 & 1 \end{pmatrix}.$$

Thus, we have

$$R = \sqrt{R^2} = \sqrt{\lambda_1}P_1 + \sqrt{\lambda_2}P_2$$

$$= \frac{1}{5} \begin{pmatrix} 1 & 2 \\ 2 & 4 \end{pmatrix} + \frac{4}{5} \begin{pmatrix} 4 & -2 \\ -2 & 1 \end{pmatrix} = \frac{1}{5} \begin{pmatrix} 17 & -6 \\ -6 & 8 \end{pmatrix}.$$

We note that \mathbf{A} is invertible. Thus, \mathbf{R} is also invertible, and

$$\mathbf{R}^{-1} = \frac{1}{20} \begin{pmatrix} 8 & 6 \\ 6 & 17 \end{pmatrix}.$$

This gives $\mathbf{O} = \mathbf{A}\mathbf{R}^{-1}$, or

$$\mathbf{O} = \frac{1}{5} \begin{pmatrix} 4 & 3 \\ 3 & -4 \end{pmatrix}.$$

It is readily verified that \mathbf{O} is indeed orthogonal.

6.8 Problems

6.1 Let \mathbf{P} be the (hermitian) projection operator onto a subspace \mathcal{M} . Show that $\mathbf{1} - \mathbf{P}$ projects onto \mathcal{M}^\perp . Hint: You need to show that $\langle m|\mathbf{P}|a\rangle = \langle m|a\rangle$ for arbitrary $|a\rangle \in \mathcal{V}$ and $|m\rangle \in \mathcal{M}$; therefore, consider $\langle m|\mathbf{P}|a\rangle^*$, and use the hermiticity of \mathbf{P} .

6.2 Show that a subspace \mathcal{M} of an inner product space \mathcal{V} is invariant under the linear operator \mathbf{A} if and only if \mathcal{M}^\perp is invariant under \mathbf{A}^\dagger .

6.3 Show that the intersection of two invariant subspaces of an operator is also an invariant subspace.

6.4 Let π be a permutation of the integers $\{1, 2, \dots, n\}$. Find the spectrum of \mathbf{A}_π , if for $|x\rangle = (\alpha_1, \alpha_2, \dots, \alpha_n) \in \mathbb{C}^n$, we define

$$\mathbf{A}_\pi|x\rangle = (\alpha_{\pi(1)}, \dots, \alpha_{\pi(n)}).$$

6.5 Let $|a_1\rangle \equiv \mathbf{a}_1 = (1, 1, -1)$ and $|a_2\rangle \equiv \mathbf{a}_2 = (-2, 1, -1)$.

- Construct (in the form of a matrix) the projection operators \mathbf{P}_1 and \mathbf{P}_2 that project onto the directions of $|a_1\rangle$ and $|a_2\rangle$, respectively. Verify that they are indeed projection operators.
- Construct (in the form of a matrix) the operator $\mathbf{P} = \mathbf{P}_1 + \mathbf{P}_2$ and verify directly that it is a projection operator.
- Let \mathbf{P} act on an arbitrary vector (x, y, z) . What is the dot product of the resulting vector with the vector $\mathbf{a}_1 \times \mathbf{a}_2$? Is that what you expect?

6.6 Show that

- the coefficient of λ^N in the characteristic polynomial of any linear operator is $(-1)^N$, where $N = \dim \mathcal{V}$, and
- the constant in the characteristic polynomial of an operator is its determinant.

6.7 Operators \mathbf{A} and \mathbf{B} satisfy the commutation relation $[\mathbf{A}, \mathbf{B}] = \mathbf{1}$. Let $|b\rangle$ be an eigenvector of \mathbf{B} with eigenvalue λ . Show that $e^{-\tau\mathbf{A}}|b\rangle$ is also an eigenvector of \mathbf{B} , but with eigenvalue $\lambda + \tau$. This is why $e^{-\tau\mathbf{A}}$ is called the **translation operator** for \mathbf{B} . Hint: First find $[\mathbf{B}, e^{-\tau\mathbf{A}}]$.

translation operator

6.8 Find the eigenvalues of an *involutive* operator, that is, an operator \mathbf{A} with the property $\mathbf{A}^2 = \mathbf{1}$.

6.9 Assume that \mathbf{A} and \mathbf{A}' are similar matrices. Show that they have the same eigenvalues.

6.10 In each of the following cases, determine the counterclockwise rotation of the xy -axes that brings the conic section into the standard form and determine the conic section.

$$(a) \quad 11x^2 + 3y^2 + 6xy - 12 = 0,$$

$$(b) \quad 5x^2 - 3y^2 + 6xy + 6 = 0,$$

$$(c) \quad 2x^2 - y^2 - 4xy - 3 = 0,$$

$$(d) \quad 6x^2 + 3y^2 - 4xy - 7 = 0,$$

$$(e) \quad 2x^2 + 5y^2 - 4xy - 36 = 0.$$

6.11 Show that if \mathbf{A} is invertible, then the eigenvectors of \mathbf{A}^{-1} are the same as those of \mathbf{A} and the eigenvalues of \mathbf{A}^{-1} are the reciprocals of those of \mathbf{A} .

6.12 Find all eigenvalues and eigenvectors of the following matrices:

$$\begin{aligned} \mathbf{A}_1 &= \begin{pmatrix} 1 & 1 \\ 0 & i \end{pmatrix} & \mathbf{B}_1 &= \begin{pmatrix} 0 & 1 \\ 0 & 0 \end{pmatrix} & \mathbf{C}_1 &= \begin{pmatrix} 2 & -2 & -1 \\ -1 & 3 & 1 \\ 2 & -4 & -1 \end{pmatrix} \\ \mathbf{A}_2 &= \begin{pmatrix} 1 & 0 & 1 \\ 0 & 1 & 0 \\ 1 & 0 & 1 \end{pmatrix} & \mathbf{B}_2 &= \begin{pmatrix} 1 & 1 & 0 \\ 1 & 0 & 1 \\ 0 & 1 & 1 \end{pmatrix} & \mathbf{C}_2 &= \begin{pmatrix} -1 & 1 & 1 \\ 1 & -1 & 1 \\ 1 & 1 & -1 \end{pmatrix} \\ \mathbf{A}_3 &= \begin{pmatrix} 1 & 1 & 1 \\ 0 & 1 & 1 \\ 0 & 0 & 1 \end{pmatrix} & \mathbf{B}_3 &= \begin{pmatrix} 1 & 1 & 1 \\ 1 & 1 & 1 \\ 1 & 1 & 1 \end{pmatrix} & \mathbf{C}_3 &= \begin{pmatrix} 0 & 1 & 1 \\ 1 & 0 & 1 \\ 1 & 1 & 0 \end{pmatrix} \end{aligned}$$

6.13 Show that a 2×2 rotation matrix does not have a real eigenvalue (and, therefore, eigenvector) when the rotation angle is not an integer multiple of π . What is the physical interpretation of this?

6.14 Three equal point masses are located at $(a, a, 0)$, $(a, 0, a)$, and $(0, a, a)$. Find the moment of inertia matrix as well as its eigenvalues and the corresponding eigenvectors.

6.15 Consider $(\alpha_1, \alpha_2, \dots, \alpha_n) \in \mathbb{C}^n$ and define \mathbf{E}_{ij} as the operator that interchanges α_i and α_j . Find the eigenvalues of this operator.

6.16 Find the eigenvalues and eigenvectors of the operator $-id/dx$ acting in the vector space of differentiable functions $\mathcal{C}^1(-\infty, \infty)$.

6.17 Show that a hermitian operator is positive iff its eigenvalues are positive.

6.18 Show that $\|\mathbf{A}x\| = \|\mathbf{A}^\dagger x\|$ if and only if \mathbf{A} is normal.

6.19 What are the spectral decompositions of \mathbf{A}^\dagger , \mathbf{A}^{-1} , and $\mathbf{A}\mathbf{A}^\dagger$ for an invertible normal operator \mathbf{A} ?

6.20 Consider the matrix

$$\mathbf{A} = \begin{pmatrix} 2 & 1+i \\ 1-i & 3 \end{pmatrix}.$$

- Find the eigenvalues and the orthonormal eigenvectors of \mathbf{A} .
- Calculate the projection operators (matrices) \mathbf{P}_1 and \mathbf{P}_2 and verify that $\sum_i \mathbf{P}_i = \mathbf{1}$ and $\sum_i \lambda_i \mathbf{P}_i = \mathbf{A}$.
- Find the matrices $\sqrt{\mathbf{A}}$, $\sin(\theta\mathbf{A})$, and $\cos(\theta\mathbf{A})$ and show directly that

$$\sin^2(\theta\mathbf{A}) + \cos^2(\theta\mathbf{A}) = \mathbf{1}.$$

- Is \mathbf{A} invertible? If so, find \mathbf{A}^{-1} using spectral decomposition of \mathbf{A} .

6.21 Consider the matrix

$$\mathbf{A} = \begin{pmatrix} 4 & i & 1 \\ -i & 4 & -i \\ 1 & i & 4 \end{pmatrix}.$$

- Find the eigenvalues of \mathbf{A} . Hint: Try $\lambda = 3$ in the characteristic polynomial of \mathbf{A} .
- For each λ , find a basis for \mathcal{M}_λ the eigenspace associated with the eigenvalue λ .
- Use the Gram-Schmidt process to orthonormalize the above basis vectors.
- Calculate the projection operators (matrices) \mathbf{P}_i for each subspace and verify that $\sum_i \mathbf{P}_i = \mathbf{1}$ and $\sum_i \lambda_i \mathbf{P}_i = \mathbf{A}$.
- Find the matrices $\sqrt{\mathbf{A}}$, $\sin(\pi\mathbf{A}/2)$, and $\cos(\pi\mathbf{A}/2)$.
- Is \mathbf{A} invertible? If so, find the eigenvalues and eigenvectors of \mathbf{A}^{-1} .

6.22 Show that if two hermitian matrices have the same set of eigenvalues, then they are unitarily related.

6.23 Prove that corresponding to every unitary operator \mathbf{U} acting on a finite-dimensional vector space, there is a hermitian operator \mathbf{H} such that $\mathbf{U} = \exp(i\mathbf{H})$.

6.24 Prove Lemma 6.6.4 by showing that

$$\langle a | \mathbf{T}^2 + \alpha \mathbf{T} + \beta \mathbf{1} | a \rangle \geq \| \mathbf{T}a \|^2 - |\alpha| \| \mathbf{T}a \| \| a \| + \beta \langle a | a \rangle,$$

which can be obtained from the Schwarz inequality in the form $|\langle a | b \rangle| \geq -\|a\| \|b\|$. Now complete the square on the right-hand side.

6.25 Show that a normal operator \mathbf{T} on a real vector space can be diagonalized as in Eqs. (6.23) and (6.24).

6.26 Show that an arbitrary matrix A can be “diagonalized” as $D = UAV$, where U is unitary and D is a real diagonal matrix with only nonnegative eigenvalues. Hint: There exists a unitary matrix that diagonalizes AA^\dagger .

6.27 Find the polar decomposition of the following matrices:

$$A = \begin{pmatrix} 2i & 0 \\ \sqrt{7} & 3 \end{pmatrix}, \quad B = \begin{pmatrix} 41 & -12i \\ 12i & 34 \end{pmatrix}, \quad C = \begin{pmatrix} 1 & 0 & 1 \\ 0 & 1 & -i \\ 1 & i & 0 \end{pmatrix}.$$

6.28 Show that for an arbitrary matrix A , both AA^\dagger and $A^\dagger A$ have the same set of eigenvalues. Hint: Use the polar decomposition theorem.

6.29 Show that

- (a) if λ is an eigenvalue of an antisymmetric operator, then so is $-\lambda$, and
- (b) antisymmetric operators (matrices) of odd dimension cannot be invertible.

6.30 Find the unitary matrices that diagonalize the following hermitian matrices:

$$A_1 = \begin{pmatrix} 2 & -1+i \\ -1-i & -1 \end{pmatrix}, \quad A_2 = \begin{pmatrix} 3 & i \\ -i & 3 \end{pmatrix}, \quad A_3 = \begin{pmatrix} 1 & -i \\ i & 0 \end{pmatrix},$$

$$B_1 = \begin{pmatrix} 1 & -1 & -i \\ -1 & 0 & i \\ i & -i & -1 \end{pmatrix}, \quad B_2 = \begin{pmatrix} 2 & 0 & i \\ 0 & -1 & -i \\ -i & i & 0 \end{pmatrix}.$$

Warning! You may have to resort to numerical approximations for some of these.

6.31 Let $A = \begin{pmatrix} 1 & \alpha \\ 0 & 1 \end{pmatrix}$, where $\alpha \in \mathbb{C}$ and $\alpha \neq 0$. Show that it is impossible to find an invertible 2×2 matrix R such that RAR^{-1} is diagonal. Now show that A is not normal as expected from Proposition 6.4.11.

Part II
Infinite-Dimensional Vector Spaces

The basic concepts of finite-dimensional vector spaces introduced in Chap. 2 can readily be generalized to infinite dimensions. The definition of a vector space and concepts of linear combination, linear independence, subspace, span, and so forth all carry over to infinite dimensions. However, one thing is crucially different in the new situation, and this difference makes the study of infinite-dimensional vector spaces both richer and more nontrivial: In a finite-dimensional vector space we dealt with finite sums; in infinite dimensions we encounter infinite sums. Thus, we have to investigate the convergence of such sums.

7.1 The Question of Convergence

The intuitive notion of convergence acquired in calculus makes use of the idea of closeness. This, in turn, requires the notion of distance.¹ We considered such a notion in Chap. 2 in the context of a norm, and saw that the inner product had an associated norm. However, it is possible to introduce a norm on a vector space without an inner product.

One such norm, applicable to \mathbb{C}^n and \mathbb{R}^n , was

$$\|a\|_p \equiv \left(\sum_{i=1}^n |\alpha_i|^p \right)^{1/p},$$

where p is an integer. The “natural” norm, i.e., that induced on \mathbb{C}^n (or \mathbb{R}^n) by the usual inner product, corresponds to $p = 2$. The distance between two points depends on the particular norm used. For example, consider the “point” (or vector) $|b\rangle = (0.1, 0.1, \dots, 0.1)$ in a 1000-dimensional space ($n = 1000$). One can easily check that the distance of this vector from the origin varies considerably with p : $\|b\|_1 = 100$, $\|b\|_2 = 3.16$, $\|b\|_{10} = 0.2$. This variation may give the impression that there is no such thing as “closeness”, and it all depends on how one defines the norm. This is not true,

Closeness is a relative concept!

¹It is possible to introduce the idea of closeness abstractly, without resort to the notion of distance, as is done in topology. However, distance, as applied in vector spaces, is as abstract as we want to get.

because closeness is a relative concept: One always *compares* distances. A norm with large p shrinks *all* distances of a space, and a norm with small p stretches them. Thus, although it is impossible (and meaningless) to say that “ $|a|$ is close to $|b|$ ” because of the dependence of distance on p , one can always say “ $|a|$ is closer to $|b|$ than $|c|$ is to $|d|$ ”, regardless of the value of p .

Now that we have a way of telling whether vectors are close together or far apart, we can talk about limits and the convergence of sequences of vectors. Let us begin by recalling the definition of a Cauchy sequence (see Definition 1.3.4):

Cauchy sequence defined **Definition 7.1.1** An infinite sequence of vectors $\{|a_i|\}_{i=1}^{\infty}$ in a normed linear space \mathcal{V} is called a **Cauchy sequence** if $\lim_{\substack{i \rightarrow \infty \\ j \rightarrow \infty}} \|a_i - a_j\| = 0$.

A convergent sequence is necessarily Cauchy. This can be shown using the triangle inequality (see Problem 7.2). However, there may be Cauchy sequences in a given vector space that do not converge to any vector in that space (see the example below). Such a convergence requires additional properties of a vector space summarized in the following definition.

complete vector space defined **Definition 7.1.2** A **complete vector space** \mathcal{V} is a normed linear space for which every Cauchy sequence of vectors in \mathcal{V} has a limit vector in \mathcal{V} . In other words, if $\{|a_i|\}_{i=1}^{\infty}$ is a Cauchy sequence, then there exists a vector $|a\rangle \in \mathcal{V}$ such that $\lim_{i \rightarrow \infty} \|a_i - a\rangle = 0$.

Example 7.1.3 (1) \mathbb{R} is complete with respect to the absolute-value norm $\|\alpha\| = |\alpha|$. In other words, every Cauchy sequence of real numbers has a limit in \mathbb{R} . This is proved in real analysis.

(2) \mathbb{C} is complete with respect to the norm $\|\alpha\| = |\alpha| = \sqrt{(\operatorname{Re} \alpha)^2 + (\operatorname{Im} \alpha)^2}$. Using $|\alpha| \leq |\operatorname{Re} \alpha| + |\operatorname{Im} \alpha|$, one can show that the completeness of \mathbb{C} follows from that of \mathbb{R} . Details are left as an exercise for the reader.

(3) The set of rational numbers \mathbb{Q} is *not* complete with respect to the absolute-value norm. In fact, $\{(1 + 1/k)^k\}_{k=1}^{\infty}$ is a sequence of rational numbers that is Cauchy but does not converge to a rational number; it converges to e , the base of the natural logarithm, which is known to be an irrational number. (See also the discussion after Definition 1.3.4.)

Let $\{|a_i|\}_{i=1}^{\infty}$ be a Cauchy sequence of vectors in a finite-dimensional vector space \mathcal{V}_N . Choose an orthonormal basis $\{|e_k\rangle\}_{k=1}^N$ in \mathcal{V}_N such that² $|a_i\rangle = \sum_{k=1}^N \alpha_k^{(i)} |e_k\rangle$ and $|a_j\rangle = \sum_{k=1}^N \alpha_k^{(j)} |e_k\rangle$. Then

²Recall that one can always define an inner product on a finite-dimensional vector space. So, the existence of orthonormal bases is guaranteed.

$$\begin{aligned}\|a_i - a_j\|^2 &= \langle a_i - a_j | a_i - a_j \rangle = \left\| \sum_{k=1}^N (\alpha_k^{(i)} - \alpha_k^{(j)}) |e_k\rangle \right\|^2 \\ &= \sum_{k,l=1}^N (\alpha_k^{(i)} - \alpha_k^{(j)})^* (\alpha_l^{(i)} - \alpha_l^{(j)}) \langle e_k | e_l \rangle = \sum_{k=1}^N |\alpha_k^{(i)} - \alpha_k^{(j)}|^2.\end{aligned}$$

The LHS goes to zero, because the sequence is assumed Cauchy. Furthermore, all terms on the RHS are positive. Thus, they too must go to zero as $i, j \rightarrow \infty$. By the completeness of \mathbb{C} , there must exist $\alpha_k \in \mathbb{C}$ such that $\lim_{n \rightarrow \infty} \alpha_k^{(n)} = \alpha_k$ for $k = 1, 2, \dots, N$. Now consider $|a\rangle \in \mathcal{V}_N$ given by $|a\rangle = \sum_{k=1}^N \alpha_k |e_k\rangle$. We claim that $|a\rangle$ is the limit of the above sequence of vectors in \mathcal{V}_N . Indeed,

$$\lim_{i \rightarrow \infty} \|a_i - a\|^2 = \lim_{i \rightarrow \infty} \sum_{k=1}^N |\alpha_k^{(i)} - \alpha_k|^2 = \sum_{k=1}^N \lim_{i \rightarrow \infty} |\alpha_k^{(i)} - \alpha_k|^2 = 0.$$

We have proved the following:

Proposition 7.1.4 *Every Cauchy sequence in a finite-dimensional inner product space over \mathbb{C} (or \mathbb{R}) is convergent. In other words, every finite-dimensional complex (or real) inner product space is complete with respect to the norm induced by its inner product.*

all finite-dimensional vector spaces are complete

The next example shows how important the word “finite” is.

Example 7.1.5 Consider $\{f_k\}_{k=1}^\infty$, the infinite sequence of *continuous* functions defined in the interval $[-1, +1]$ by

$$f_k(x) = \begin{cases} 1 & \text{if } 1/k \leq x \leq 1, \\ (kx + 1)/2 & \text{if } -1/k \leq x \leq 1/k, \\ 0 & \text{if } -1 \leq x \leq -1/k. \end{cases}$$

This sequence belongs to $\mathcal{C}^0(-1, 1)$, the inner product space of continuous functions with its usual inner product: $\langle f | g \rangle = \int_{-1}^1 f^*(x)g(x) dx$. It is straightforward to verify that $\|f_k - f_j\|^2 = \int_{-1}^1 |f_k(x) - f_j(x)|^2 dx \xrightarrow[k, j \rightarrow \infty]{} 0$. Therefore, the sequence is Cauchy. However, the limit of this sequence is (see Fig. 7.1)

$$f(x) = \begin{cases} 1 & \text{if } 0 < x \leq 1, \\ 0 & \text{if } -1 \leq x < 0, \end{cases}$$

which is discontinuous at $x = 0$ and therefore does not belong to the space in which the original sequence lies.

We see that infinite-dimensional vector spaces are not generally complete. It is a nontrivial task to show whether or not a given infinite-dimensional vector space is complete.

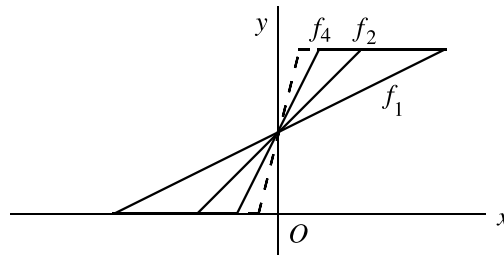

Fig. 7.1 The limit of the sequence of the *continuous* functions f_k is a discontinuous function that is 1 for $x > 0$ and 0 for $x < 0$

Any vector space (finite- or infinite-dimensional) contains all finite linear combinations of the form $\sum_{i=1}^n \alpha_i |a_i\rangle$ when it contains all the $|a_i\rangle$'s. This follows from the very definition of a vector space. However, the situation is different when n goes to infinity. For the vector space to contain the infinite sum, firstly, the meaning of such a sum has to be clarified, i.e., a norm and an associated convergence criterion needs to be put in place. Secondly, the vector space has to be complete with respect to that norm. A complete normed vector space is called a **Banach space**. We shall not deal with a general Banach space, but only with those spaces whose norms arise naturally from an inner product. This leads to the following definition:

Banach space

Definition 7.1.6 A complete inner product space, commonly denoted by \mathcal{H} , is called a **Hilbert space**.

Hilbert space defined

Thus, all finite-dimensional real or complex vector spaces are Hilbert spaces. However, when we speak of a Hilbert space, we shall usually assume that it is infinite-dimensional.

It is convenient to use orthonormal vectors in studying Hilbert spaces. So, let us consider an infinite sequence $\{|e_i\rangle\}_{i=1}^\infty$ of orthonormal vectors all belonging to a Hilbert space \mathcal{H} . Next, take any vector $|f\rangle \in \mathcal{H}$, construct the complex numbers $f_i = \langle e_i | f \rangle$, and form the sequence of vectors³

$$|f_n\rangle = \sum_{i=1}^n f_i |e_i\rangle \quad \text{for } n = 1, 2, \dots \tag{7.1}$$

For the pair of vectors $|f\rangle$ and $|f_n\rangle$, the Schwarz inequality gives

$$|\langle f | f_n \rangle|^2 \leq \langle f | f \rangle \langle f_n | f_n \rangle = \langle f | f \rangle \left(\sum_{i=1}^n |f_i|^2 \right), \tag{7.2}$$

³We can consider $|f_n\rangle$ as an “approximation” to $|f\rangle$, because both share the same components along the same set of orthonormal vectors. The sequence of orthonormal vectors acts very much as a basis. However, to be a basis, an extra condition must be met. We shall discuss this condition shortly.

where Eq. (7.1) has been used to evaluate $\langle f_n | f_n \rangle$. On the other hand, taking the inner product of (7.1) with $\langle f |$ yields

$$\langle f | f_n \rangle = \sum_{i=1}^n f_i \langle f | e_i \rangle = \sum_{i=1}^n f_i f_i^* = \sum_{i=1}^n |f_i|^2.$$

Substitution of this in Eq. (7.2) yields the **Parseval inequality**:

Parseval inequality

$$\sum_{i=1}^n |f_i|^2 \leq \langle f | f \rangle. \quad (7.3)$$

This conclusion is true for arbitrarily large n and can be stated as follows:

Proposition 7.1.7 *Let $\{|e_i\rangle\}_{i=1}^{\infty}$ be an infinite set of orthonormal vectors in a Hilbert space, \mathcal{H} . Let $|f\rangle \in \mathcal{H}$ and define complex numbers $f_i = \langle e_i | f \rangle$. Then the **Bessel inequality** holds: $\sum_{i=1}^{\infty} |f_i|^2 \leq \langle f | f \rangle$.*

Bessel inequality

The Bessel inequality shows that the vector

$$\sum_{i=1}^{\infty} f_i |e_i\rangle \equiv \lim_{n \rightarrow \infty} \sum_{i=1}^n f_i |e_i\rangle$$

converges; that is, it has a finite norm. However, the inequality does not say whether the vector converges to $|f\rangle$. To make such a statement we need completeness:

Definition 7.1.8 A sequence of orthonormal vectors $\{|e_i\rangle\}_{i=1}^{\infty}$ in a Hilbert space \mathcal{H} is called **complete** if the only vector in \mathcal{H} that is orthogonal to all the $|e_i\rangle$ is the zero vector, in which case $\{|e_i\rangle\}_{i=1}^{\infty}$ is called a **basis** for \mathcal{H} .

complete orthonormal
sequence of vectors;
basis for \mathcal{H}

The notion of completeness does not enter the discussion of an N -dimensional vector space, because any N orthonormal vectors form a basis. If you take away some of the vectors, you don't have a basis, because you have less than N vectors. The situation is different in infinite dimensions. If you start with a basis and take away some of the vectors, you still have an *infinite* number of orthonormal vectors. The notion of completeness ensures that no orthonormal vector is taken out of a basis. This completeness property is the extra condition alluded to (in the footnote) above, and is what is required to make a basis.

In mathematics literature, one distinguishes between a general and a *separable* Hilbert space. The latter is characterized by having a *countable* basis. Thus, in the definition above, the Hilbert space is actually a separable one, and from now on, by Hilbert space we shall mean a separable Hilbert space.

Proposition 7.1.9 *Let $\{|e_i\rangle\}_{i=1}^{\infty}$ be an orthonormal sequence in \mathcal{H} . Then the following statements are equivalent:*

1. $\{|e_i\rangle\}_{i=1}^{\infty}$ is complete.
2. $|f\rangle = \sum_{i=1}^{\infty} |e_i\rangle \langle e_i | f \rangle \quad \forall |f\rangle \in \mathcal{H}$.

3. $\sum_{i=1}^{\infty} |e_i\rangle\langle e_i| = \mathbf{1}$.
4. $\langle f|g\rangle = \sum_{i=1}^{\infty} \langle f|e_i\rangle\langle e_i|g\rangle \forall |f\rangle, |g\rangle \in \mathcal{H}$.
5. $\|f\|^2 = \sum_{i=1}^{\infty} |\langle e_i|f\rangle|^2 \forall |f\rangle \in \mathcal{H}$.

Proof We shall prove the implications $1 \Rightarrow 2 \Rightarrow 3 \Rightarrow 4 \Rightarrow 5 \Rightarrow 1$.

$1 \Rightarrow 2$: It is sufficient to show that the vector $|\psi\rangle \equiv |f\rangle - \sum_{i=1}^{\infty} |e_i\rangle\langle e_i|f\rangle$ is orthogonal to all the $|e_j\rangle$:

$$\langle e_j|\psi\rangle = \langle e_j|f\rangle - \sum_{i=1}^{\infty} \overbrace{\langle e_j|e_i\rangle}^{\delta_{ij}} \langle e_i|f\rangle = 0.$$

$2 \Rightarrow 3$: Since $|f\rangle = \mathbf{1}|f\rangle = \sum_{i=1}^{\infty} (|e_i\rangle\langle e_i|)|f\rangle$ is true for all $|f\rangle \in \mathcal{H}$, we must have $\mathbf{1} = \sum_{i=1}^{\infty} |e_i\rangle\langle e_i|$.

$3 \Rightarrow 4$: $\langle f|g\rangle = \langle f|\mathbf{1}|g\rangle = \langle f|(\sum_{i=1}^{\infty} |e_i\rangle\langle e_i|)|g\rangle = \sum_{i=1}^{\infty} \langle f|e_i\rangle\langle e_i|g\rangle$.

$4 \Rightarrow 5$: Let $|g\rangle = |f\rangle$ in statement 4 and recall that $\langle f|e_i\rangle = \langle e_i|f\rangle^*$.

$5 \Rightarrow 1$: Let $|f\rangle$ be orthogonal to all the $|e_i\rangle$. Then all the terms in the sum are zero implying that $\|f\|^2 = 0$, which in turn gives $|f\rangle = 0$, because only the zero vector has a zero norm. \square

Parseval equality;
generalized Fourier
coefficients

The equality

$$\|f\|^2 = \langle f|f\rangle = \sum_{i=1}^{\infty} |\langle e_i|f\rangle|^2 = \sum_{i=1}^{\infty} |f_i|^2, \quad f_i = \langle e_i|f\rangle, \quad (7.4)$$

is called the **Parseval equality**, and the complex numbers f_i are called **generalized Fourier coefficients**. The relation

$$\mathbf{1} = \sum_{i=1}^{\infty} |e_i\rangle\langle e_i| \quad (7.5)$$

completeness relation is called the **completeness relation**.



David Hilbert 1862–1943

Historical Notes

David Hilbert (1862–1943), the greatest mathematician of the twentieth century, received his Ph.D. from the University of Königsberg and was a member of the staff there from 1886 to 1895. In 1895 he was appointed to the chair of mathematics at the University of Göttingen, where he continued to teach for the rest of his life.

Hilbert is one of that rare breed of late 19th-century mathematicians whose spectrum of expertise covered a wide range, with formal set theory at one end and mathematical physics at the other. He did superb work in geometry, algebraic geometry, algebraic number theory, integral equations, and operator theory. The seminal two-volume book *Methoden der mathematische Physik* by R. Courant, still one of the best books on the subject, was greatly influenced by Hilbert.

Hilbert's work in geometry had the greatest influence in that area since Euclid. A systematic study of the axioms of Euclidean geometry led Hilbert to propose 21 such axioms, and he analyzed their significance. He published *Grundlagen der Geometrie* in 1899, putting geometry on a formal axiomatic foundation. His famous 23 Paris problems challenged (and still today challenge) mathematicians to solve fundamental questions.

It was late in his career that Hilbert turned to the subject for which he is most famous among physicists. A lecture by Erik Holmgren in 1901 on Fredholm's work on integral equations, which had already been published in Sweden, aroused Hilbert's interest in

the subject. David Hilbert, having established himself as the leading mathematician of his time by his work on algebraic numbers, algebraic invariants, and the foundations of geometry, now turned his attention to **integral equations**. He says that an investigation of the subject showed him that it was important for the theory of definite integrals, for the development of arbitrary functions in series (of special functions or trigonometric functions), for the theory of linear differential equations, for potential theory, and for the calculus of variations. He wrote a series of six papers from 1904 to 1910 and reproduced them in his book *Grundzüge einer allgemeinen Theorie der linearen Integralgleichungen* (1912). During the latter part of this work he applied integral equations to problems of mathematical physics.

It is said that Hilbert discovered the correct field equation for general relativity in 1915 (one year before Einstein) using the variational principle, but never claimed priority.

Hilbert claimed that he worked best out-of-doors. He accordingly attached an 18-foot blackboard to his neighbor's wall and built a covered walkway there so that he could work outside in any weather. He would intermittently interrupt his pacing and his blackboard computations with a few turns around the rest of the yard on his bicycle, or he would pull some weeds, or do some garden trimming. Once, when a visitor called, the maid sent him to the backyard and advised that if the master wasn't readily visible at the blackboard to look for him up in one of the trees.

Highly gifted and highly versatile, David Hilbert radiated over mathematics a catching optimism and a stimulating vitality that can only be called "the spirit of Hilbert." Engraved on a stone marker set over Hilbert's grave in Göttingen are the master's own optimistic words: "Wir müssen wissen. Wir werden wissen." ("We must know. We shall know.")

"Wir müssen wissen. Wir werden wissen."

7.2 The Space of Square-Integrable Functions

Chapter 2 showed that the collection of all continuous functions defined on an interval $[a, b]$ forms a linear vector space. Example 7.1.5 showed that this space is not complete. Can we enlarge this space to make it complete? Since we are interested in an inner product as well, and since a natural inner product for functions is defined in terms of integrals, we want to make sure that our functions are integrable. However, integrability does not require continuity, it only requires *piecewise* continuity. In this section we shall discuss conditions under which the space of functions becomes complete. An important class of functions has already been mentioned in Chap. 2. These functions satisfy the inner product given by

$$\langle g|f \rangle = \int_a^b g^*(x)f(x)w(x) dx.$$

If $g(x) = f(x)$, we obtain

$$\langle f|f \rangle = \int_a^b |f(x)|^2 w(x) dx. \quad (7.6)$$

Functions for which such an integral is defined are said to be **square-integrable**.

square-integrable functions

The space of square-integrable functions over the interval $[a, b]$ is denoted by $\mathcal{L}_w^2(a, b)$. In this notation \mathcal{L} stands for *Lebesgue*, who generalized the notion of the ordinary Riemann integral to cases for which the integrand could be highly discontinuous; 2 stands for the power of $f(x)$ in the integral; a and b denote the limits of integration; and w refers to the weight function

(a strictly positive real-valued function). When $w(x) = 1$, we use the notation $\mathcal{L}^2(a, b)$. The significance of $\mathcal{L}_w^2(a, b)$ lies in the following theorem (for a proof, see [Reed 80, Chap. III]):

$\mathcal{L}_w^2(a, b)$ is complete **Theorem 7.2.1** (Riesz-Fischer theorem) *The space $\mathcal{L}_w^2(a, b)$ is complete.*

A complete infinite-dimensional inner product space was earlier defined to be a Hilbert space. The following theorem shows that the number of all Hilbert spaces are alike (separable) Hilbert spaces is severely restricted. (For a proof, see [Frie 82, p. 216].)

Theorem 7.2.2 *All complete inner product spaces with countable bases are isomorphic to $\mathcal{L}_w^2(a, b)$.*

$\mathcal{L}_w^2(a, b)$ is defined in terms of functions that satisfy Eq. (7.6). Yet an inner product involves integrals of the form $\int_a^b g^*(x)f(x)w(x)dx$. Are such integrals well-defined and finite? Using the Schwarz inequality, which holds for any inner product space, finite or infinite, one can show that the integral is defined.

The isomorphism of Theorem 7.2.2 makes the Hilbert space more tangible, because it identifies the space with a space of functions, objects that are more familiar than abstract vectors. Nonetheless, a faceless function is very little improvement over an abstract vector. What is desirable is a set of concrete functions with which we can calculate. The following theorem provides such functions (for a proof, see [Simm 83, pp. 154–161]).

Theorem 7.2.3 (Stone-Weierstrass approximation theorem) *The sequence of monomials $\{x^k\}_{k=0}^\infty$ forms a basis of $\mathcal{L}_w^2(a, b)$.*

Thus, any square-integrable function f can be written as $f(x) = \sum_{k=0}^\infty \alpha_k x^k$. This theorem shows that $\mathcal{L}_w^2(a, b)$ is indeed a *separable* Hilbert space as expected in Theorem 7.2.2.

7.2.1 Orthogonal Polynomials

The monomials $\{x^k\}_{k=0}^\infty$ are not orthonormal but are linearly independent. If we wish to obtain an orthonormal—or simply orthogonal—linear combination of these vectors, we can use the Gram-Schmidt process. The result will be certain polynomials, denoted by $C_n(x)$, that are orthogonal to one another and span $\mathcal{L}_w^2(a, b)$.

the polynomials $\{C_n(x)\}_{n=0}^\infty$ are orthogonal to each other

Such orthogonal polynomials satisfy very useful **recurrence relations**, which we now derive. In the following discussion $p_{\leq k}(x)$ denotes a generic polynomial of degree less than or equal to k . For example, $3x^5 - 4x^2 + 5$, $2x + 1$, $-2.4x^4 + 3x^3 - x^2 + 6$, and 2 are all denoted by $p_{\leq 5}(x)$ or $p_{\leq 8}(x)$ or $p_{\leq 59}(x)$ because they all have degrees less than or equal to 5 , 8 ,

and 59. Since a polynomial of degree less than n can be written as a linear combination of $C_k(x)$ with $k < n$, we have the obvious property

$$\int_a^b C_n(x) p_{\leq n-1}(x) w(x) dx = 0. \quad (7.7)$$

Let $k_m^{(m)}$ and $k_m^{(m-1)}$ denote, respectively, the coefficients of x^m and x^{m-1} in $C_m(x)$, and let

$$h_m = \int_a^b [C_m(x)]^2 w(x) dx. \quad (7.8)$$

The polynomial $C_{n+1}(x) - (k_{n+1}^{(n+1)}/k_n^{(n)})x C_n(x)$ has degree less than or equal to n , and therefore can be expanded as a linear combination of the $C_j(x)$:

$$C_{n+1}(x) - \frac{k_{n+1}^{(n+1)}}{k_n^{(n)}} x C_n(x) = \sum_{j=0}^n a_j C_j(x). \quad (7.9)$$

Take the inner product of both sides of this equation with $C_m(x)$:

$$\begin{aligned} \int_a^b C_{n+1}(x) C_m(x) w(x) dx - \frac{k_{n+1}^{(n+1)}}{k_n^{(n)}} \int_a^b x C_n(x) C_m(x) w(x) dx \\ = \sum_{j=0}^n a_j \int_a^b C_j(x) C_m(x) w(x) dx. \end{aligned}$$

The first integral on the LHS vanishes as long as $m \leq n$; the second integral vanishes if $m \leq n - 2$ [if $m \leq n - 2$, then $x C_m(x)$ is a polynomial of degree $n - 1$]. Thus, we have

$$\sum_{j=0}^n a_j \int_a^b C_j(x) C_m(x) w(x) dx = 0 \quad \text{for } m \leq n - 2.$$

The integral in the sum is zero unless $j = m$, by orthogonality. Therefore, the sum reduces to

$$a_m \int_a^b [C_m(x)]^2 w(x) dx = 0 \quad \text{for } m \leq n - 2.$$

Since the integral is nonzero, we conclude that $a_m = 0$ for $m = 0, 1, 2, \dots, n - 2$, and Eq. (7.9) reduces to

$$C_{n+1}(x) - \frac{k_{n+1}^{(n+1)}}{k_n^{(n)}} x C_n(x) = a_{n-1} C_{n-1}(x) + a_n C_n(x). \quad (7.10)$$

It can be shown that if we define

$$\alpha_n = \frac{k_{n+1}^{(n+1)}}{k_n^{(n)}}, \quad \beta_n = \alpha_n \left(\frac{k_{n+1}^{(n)}}{k_{n+1}^{(n+1)}} - \frac{k_n^{(n-1)}}{k_n^{(n)}} \right), \quad \gamma_n = -\frac{h_n}{h_{n-1}} \frac{\alpha_n}{\alpha_{n-1}}, \quad (7.11)$$

then Eq. (7.10) can be expressed as

$$C_{n+1}(x) = (\alpha_n x + \beta_n)C_n(x) + \gamma_n C_{n-1}(x), \quad (7.12)$$

or

$$xC_n(x) = \frac{1}{\alpha_n} C_{n+1}(x) - \frac{\beta_n}{\alpha_n} C_n(x) - \frac{\gamma_n}{\alpha_n} C_{n-1}(x). \quad (7.13)$$

a recurrence relation for orthogonal polynomials

Other recurrence relations, involving higher powers of x , can be obtained from the one above. For example, a recurrence relation involving x^2 can be obtained by multiplying both sides of Eq. (7.13) by x and expanding each term of the RHS using that same equation. The result will be

$$\begin{aligned} x^2 C_n(x) &= \frac{1}{\alpha_n \alpha_{n+1}} C_{n+2}(x) - \left(\frac{\beta_{n+1}}{\alpha_n \alpha_{n+1}} + \frac{\beta_n}{\alpha_n^2} \right) C_{n+1}(x) \\ &\quad - \left(\frac{\gamma_{n+1}}{\alpha_n \alpha_{n+1}} - \frac{\beta_n^2}{\alpha_n^2} + \frac{\gamma_n}{\alpha_n \alpha_{n-1}} \right) C_n(x) \\ &\quad + \left(\frac{\beta_n \gamma_n}{\alpha_n^2} + \frac{\beta_{n-1} \gamma_n}{\alpha_n \alpha_{n-1}} \right) C_{n-1}(x) + \frac{\gamma_{n-1} \gamma_n}{\alpha_n \alpha_{n-1}} C_{n-2}(x). \end{aligned} \quad (7.14)$$

Example 7.2.4 As an application of the recurrence relations above, let us evaluate

$$I_1 \equiv \int_a^b x C_m(x) C_n(x) w(x) dx.$$

Substituting (7.13) in the integral gives

$$\begin{aligned} I_1 &= \frac{1}{\alpha_n} \int_a^b C_m(x) C_{n+1}(x) w(x) dx - \frac{\beta_n}{\alpha_n} \int_a^b C_m(x) C_n(x) w(x) dx \\ &\quad - \frac{\gamma_n}{\alpha_n} \int_a^b C_m(x) C_{n-1}(x) w(x) dx. \end{aligned}$$

We now use the orthogonality relations among the $C_k(x)$ to obtain

$$\begin{aligned} I_1 &= \frac{1}{\alpha_n} \delta_{m,n+1} \overbrace{\int_a^b C_m^2(x) w(x) dx}^{=h_m} - \frac{\beta_n}{\alpha_n} \delta_{mn} \int_a^b C_m^2(x) w(x) dx \\ &\quad - \frac{\gamma_n}{\alpha_n} \delta_{m,n-1} \int_a^b C_m^2(x) w(x) dx \\ &= \left(\frac{1}{\alpha_{m-1}} \delta_{m,n+1} - \frac{\beta_m}{\alpha_m} \delta_{mn} - \frac{\gamma_{m+1}}{\alpha_{m+1}} \delta_{m,n-1} \right) h_m, \end{aligned}$$

or

$$I_1 = \begin{cases} h_m / \alpha_{m-1} & \text{if } m = n + 1, \\ -\beta_m h_m / \alpha_m & \text{if } m = n, \\ -\gamma_{m+1} h_m / \alpha_{m+1} & \text{if } m = n - 1, \\ 0 & \text{otherwise.} \end{cases}$$

Example 7.2.5 Let us find the orthogonal polynomials forming a basis of $\mathcal{L}^2(-1, +1)$, which we denote by $P_n(x)$, where n is the degree of the polynomial. Let $P_0(x) = 1$. To find $P_1(x)$, write $P_1(x) = ax + b$, and determine a and b in such a way that $P_1(x)$ is orthogonal to $P_0(x)$:

$$0 = \int_{-1}^1 P_1(x)P_0(x) dx = \int_{-1}^1 (ax + b) dx = \frac{1}{2}ax^2 \Big|_{-1}^1 + 2b = 2b.$$

So one of the coefficients, b , is zero. To find the other one, we need some standardization procedure. We “standardize” $P_n(x)$ by requiring that $P_n(1) = 1 \forall n$. For $n = 1$ this yields $a \times 1 = 1$, or $a = 1$, so that $P_1(x) = x$.

We can calculate $P_2(x)$ similarly: Write $P_2(x) = ax^2 + bx + c$, impose the condition that it be orthogonal to both $P_1(x)$ and $P_0(x)$, and enforce the standardization procedure. All this will yield

$$0 = \int_{-1}^1 P_2(x)P_0(x) dx = \frac{2}{3}a + 2c, \quad 0 = \int_{-1}^1 P_2(x)P_1(x) dx = \frac{2}{3}b,$$

and $P_2(1) = a + b + c = 1$. These three equations have the unique solution $a = 3/2$, $b = 0$, $c = -1/2$. Thus, $P_2(x) = \frac{1}{2}(3x^2 - 1)$. These are the first three Legendre polynomials, which are part of a larger group of polynomials to be discussed in Chap. 8.

7.2.2 Orthogonal Polynomials and Least Squares

The method of least squares is no doubt familiar to the reader. In the simplest procedure, one tries to find a *linear function* that most closely fits a set of data. By definition, “most closely” means that the sum of the squares of the differences between the data points and the corresponding values of the linear function is minimum. More generally, one seeks the best *polynomial* fit to the data.

We shall consider a related topic, namely least-square fitting of a given *function* with polynomials. Suppose $f(x)$ is a function defined on (a, b) . We want to find a polynomial that most closely approximates f . Write such a polynomial as $p(x) = \sum_{k=0}^n a_k x^k$, where the a_k 's are to be determined such that

$$S(a_0, a_1, \dots, a_n) \equiv \int_a^b [f(x) - a_0 - a_1x - \dots - a_nx^n]^2 dx$$

is a minimum. Differentiating S with respect to the a_k 's and setting the result equal to zero gives

$$0 = \frac{\partial S}{\partial a_j} = \int_a^b 2(-x^j) \left[f(x) - \sum_{k=0}^n a_k x^k \right] dx,$$

or

$$\sum_{k=0}^n a_k \int_a^b x^{j+k} dx = \int_a^b f(x)x^j dx.$$

One can rewrite this in matrix form as $\mathbf{B}\mathbf{a} = \mathbf{c}$, where \mathbf{a} is a column vector with components a_k , and \mathbf{B} and \mathbf{c} are a matrix and a column vector whose components are

$$B_{kj} = \frac{b^{j+k+1} - a^{j+k+1}}{j+k+1} \quad \text{and} \quad c_j = \int_a^b f(x)x^j dx. \quad (7.15)$$

By solving this matrix equation, one finds the a_k 's, which in turn give the best fit.

A drawback of the procedure above is that the desire for a higher-degree polynomial fit entails the implementation of the procedure from scratch and the solution of a completely new matrix equation. One way to overcome this difficulty is to use orthogonal polynomials. Then we would have

$$S(a_0, a_1, \dots, a_n) \equiv \int_a^b \left[f(x) - \sum_{k=0}^n a_k C_k(x) \right]^2 w(x) dx,$$

where we have introduced a weight function $w(x)$ for convenience. The derivative equation becomes

$$0 = \frac{\partial S}{\partial a_j} = \int_a^b 2[-C_j(x)] \left[f(x) - \sum_{k=0}^n a_k C_k(x) \right] w(x) dx,$$

or

$$\sum_{k=0}^n a_k \underbrace{\int_a^b C_j(x) C_k(x) w(x) dx}_{=0 \text{ unless } j=k} = \int_a^b C_j(x) f(x) w(x) dx.$$

It follows that

$$a_j = \frac{\int_a^b C_j(x) f(x) w(x) dx}{\int_a^b [C_j(x)]^2 w(x) dx}, \quad j = 0, 1, \dots, n, \quad (7.16)$$

which is true regardless of the number of polynomials in the sum. Hence, once we find $\{a_j\}_{j=0}^m$, we can add the $(m+1)$ st polynomial and determine a_{m+1} from Eq. (7.16) without altering the previous coefficients.

Example 7.2.6 Let us find the least-square fit to $f(x) = \cos(\frac{1}{2}\pi x)$ in the interval $(-1, +1)$ using polynomials of second degree. First we use a single polynomial whose coefficients are determined by Eq. (7.15). We can easily calculate the column vector \mathbf{c} :

$$\begin{aligned} c_0 &= \int_{-1}^1 \cos\left(\frac{1}{2}\pi x\right) dx = \frac{4}{\pi}, \\ c_1 &= \int_{-1}^1 x \cos\left(\frac{1}{2}\pi x\right) dx = 0, \\ c_2 &= \int_{-1}^1 x^2 \cos\left(\frac{1}{2}\pi x\right) dx = -\frac{32}{\pi^3} + \frac{4}{\pi}. \end{aligned}$$

The elements of the matrix \mathbf{B} can also be calculated easily. To find the unknown a_k 's, we need to solve

$$\begin{pmatrix} 2 & 0 & \frac{2}{3} \\ 0 & \frac{2}{3} & 0 \\ \frac{2}{3} & 0 & \frac{2}{3} \end{pmatrix} \begin{pmatrix} a_0 \\ a_1 \\ a_2 \end{pmatrix} = \begin{pmatrix} \frac{4}{\pi} \\ 0 \\ -\frac{32}{\pi^3} + \frac{4}{\pi} \end{pmatrix}.$$

The solution is

$$a_0 = \frac{24}{\pi^3}, \quad a_1 = 0, \quad a_2 = \frac{6}{\pi} - \frac{72}{\pi^3}.$$

Therefore,

$$\cos\left(\frac{1}{2}\pi x\right) \approx \frac{24}{\pi^3} + \left(\frac{6}{\pi} - \frac{72}{\pi^3}\right)x^2.$$

If we wish to use orthogonal polynomials with $w(x) = 1$, we can employ the polynomials found in Example 7.2.5. Then

$$a_j = \frac{\int_{-1}^1 P_j(x) \cos\left(\frac{1}{2}\pi x\right) dx}{\int_{-1}^1 [P_j(x)]^2 dx}, \quad j = 0, 1, 2,$$

which yields

$$a_0 = \frac{2}{\pi}, \quad a_1 = 0, \quad a_2 = -\frac{120}{\pi^3} + \frac{20}{\pi}.$$

We can therefore write

$$\cos\left(\frac{1}{2}\pi x\right) \approx \frac{2}{\pi}P_0 + \left(-\frac{120}{\pi^3} + \frac{20}{\pi}\right)P_2.$$

7.3 Continuous Index

Once we allow the number of dimensions to be infinite, we open the door for numerous possibilities that are not present in the finite case. One such possibility arises because of the variety of infinities. We have encountered two types of infinity in Chap. 1, the countable infinity and the uncountable infinity. The paradigm of the former is the “number” of integers, and that of the latter is the “number” of real numbers. The nature of dimensionality of the vector space is reflected in the components of a general vector, which has a finite number of components in a finite-dimensional vector space, a countably infinite number of components in an infinite-dimensional vector space with a *countable basis*, and an uncountably infinite number of components in an infinite-dimensional vector space with no countable basis.

To gain an understanding of the nature of, and differences between, the three types of vector spaces mentioned above, it is convenient to think of components as functions of a “counting set”. Thus, the components f_i of

a vector $|f\rangle$ in an N -dimensional vector space can be thought of as values of a function f defined on the finite set $\{1, 2, \dots, N\}$, and to emphasize such functional dependence, we write $f(i)$ instead of f_i . Similarly, the components f_i of a vector $|f\rangle$ in a Hilbert space with the countable basis $B = \{|e_i\rangle\}_{i=1}^{\infty}$ can be thought of as values of a function $f : \mathbb{N} \rightarrow \mathbb{C}$, where \mathbb{N} is the (infinite) set of natural numbers. The next step is to allow the counting set to be uncountable, i.e., a continuum such as the real numbers or an interval thereof. This leads to a “component” of the form $f(x)$ corresponding to a function $f : \mathbb{R} \rightarrow \mathbb{C}$. What about the vectors themselves? What sort of a basis gives rise to such components?

Because of the isomorphism of Theorem 7.2.2, we shall concentrate on $\mathcal{L}_w^2(a, b)$. In keeping with our earlier notation, let $\{|e_x\rangle\}_{x \in \mathbb{R}}$ be a set of vectors and interpret $f(x)$ as $\langle e_x | f \rangle$. The inner product of $\mathcal{L}_w^2(a, b)$ can now be written as

$$\begin{aligned} \langle g | f \rangle &= \int_a^b g^*(x) f(x) w(x) dx = \int_a^b \langle g | e_x \rangle \langle e_x | f \rangle w(x) dx \\ &= \langle g | \left(\int_a^b |e_x\rangle w(x) \langle e_x| dx \right) | f \rangle. \end{aligned}$$

The last line suggests writing

$$\int_a^b |e_x\rangle w(x) \langle e_x| dx = \mathbf{1}.$$

completeness relation for a continuous index In the physics literature the “ e ” is ignored, and one writes $|x\rangle$ for $|e_x\rangle$. Hence, we obtain the completeness relation for a continuous index:

$$\int_a^b |x\rangle w(x) \langle x| dx = \mathbf{1}, \quad \text{or} \quad \int_a^b |x\rangle \langle x| dx = \mathbf{1}, \quad (7.17)$$

where in the second integral, $w(x)$ is set equal to unity. We also have

$$|f\rangle = \left(\int_a^b |x\rangle w(x) \langle x| dx \right) |f\rangle = \int_a^b f(x) w(x) |x\rangle dx, \quad (7.18)$$

which shows how to expand a vector $|f\rangle$ in terms of the $|x\rangle$'s.

Take the inner product of (7.18) with $\langle x'|$ to obtain

$$\langle x' | f \rangle = f(x') = \int_a^b f(x) w(x) \langle x' | x \rangle dx,$$

where x' is assumed to lie in the interval (a, b) , otherwise $f(x') = 0$ by definition. This equation, which holds for arbitrary f , tells us immediately that $w(x) \langle x' | x \rangle$ is no ordinary function of x and x' . For instance, suppose $f(x') = 0$. Then, the result of integration is always zero, regardless of the behavior of f at other points. Clearly, there is an infinitude of functions that vanish at x' , yet all of them give the same integral! Pursuing this line of argument more quantitatively, one can show that $w(x) \langle x' | x \rangle = 0$ if $x \neq x'$, $w(x) \langle x | x \rangle = \infty$, $w(x) \langle x' | x \rangle$ is an even function of $x - x'$, and

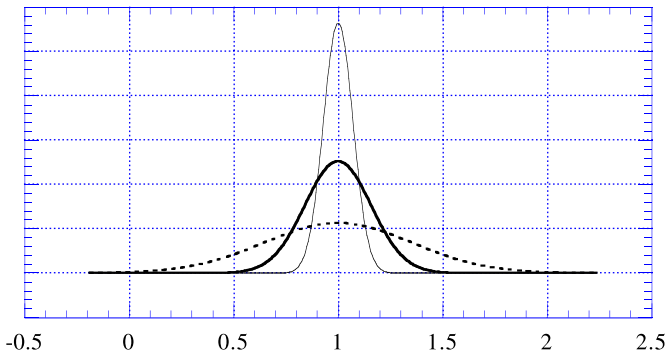

Fig. 7.2 The Gaussian bell-shaped curve approaches the Dirac delta function as the width of the curve approaches zero. The value of ϵ is 1 for the *dashed curve*, 0.25 for the *heavy curve* and 0.05 for the *light curve*

$\int_a^b w(x)\langle x'|x \rangle dx = 1$. The proof is left as a problem. The reader may recognize this as the **Dirac delta function**

$$\delta(x - x') = w(x)\langle x'|x \rangle, \quad (7.19)$$

which, for a function f defined on the interval (a, b) , has the following property:⁴

$$\int_a^b f(x)\delta(x - x') dx = \begin{cases} f(x') & \text{if } x' \in (a, b), \\ 0 & \text{if } x' \notin (a, b). \end{cases} \quad (7.20)$$

Written in the form $\langle x'|x \rangle = \delta(x - x')/w(x)$, Eq. (7.19) is the generalization of the orthonormality relation of vectors to the case of a continuous index.

The Dirac delta function is anything but a “function”. Nevertheless, there is a well-developed branch of mathematics, called generalized function theory or functional analysis, studying it and many other functions like it in a highly rigorous fashion. We shall only briefly explore this territory of mathematics in the next section. At this point we simply mention the fact that the Dirac delta function can be represented as the limit of certain sequences of ordinary functions. The following three examples illustrate some of these representations.

Example 7.3.1 Consider a Gaussian curve whose width approaches zero at the same time that its height approaches infinity in such a way that its area remains constant. In the infinite limit, we obtain the Dirac delta function. In fact, we have

$$\delta(x - x') = \lim_{\epsilon \rightarrow 0} \frac{1}{\sqrt{\epsilon\pi}} e^{-(x-x')^2/\epsilon}.$$

In the limit of $\epsilon \rightarrow 0$, the height of this Gaussian goes to infinity while its width goes to zero (see Fig. 7.2). Furthermore, for any nonzero value of ϵ ,

⁴For an elementary discussion of the Dirac delta function with many examples of its application, see [Hass 08].

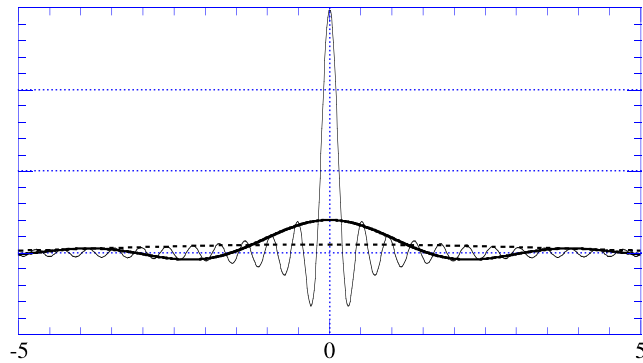

Fig. 7.3 The function $\sin Tx/x$ also approaches the Dirac delta function as the width of the curve approaches zero. The value of T is 0.5 for the *dashed curve*, 2 for the *heavy curve*, and 15 for the *light curve*

we can easily verify that

$$\int_{-\infty}^{\infty} \frac{1}{\sqrt{\epsilon\pi}} e^{-(x-x')^2/\epsilon} dx = 1.$$

This relation is independent of ϵ and therefore still holds in the limit $\epsilon \rightarrow 0$. The limit of the Gaussian behaves like the Dirac delta function.

Example 7.3.2 Consider the function $D_T(x - x')$ defined as

$$D_T(x - x') \equiv \frac{1}{2\pi} \int_{-T}^T e^{i(x-x')t} dt.$$

The integral is easily evaluated, with the result

$$D_T(x - x') = \frac{1}{2\pi} \frac{e^{i(x-x')t}}{i(x-x')} \Big|_{-T}^T = \frac{1}{\pi} \frac{\sin T(x-x')}{x-x'}.$$

The graph of $D_T(x - 0)$ as a function of x for various values of T is shown in Fig. 7.3. Note that the width of the curve decreases as T increases. The area under the curve can be calculated:

$$\int_{-\infty}^{\infty} D_T(x - x') dx = \frac{1}{\pi} \int_{-\infty}^{\infty} \frac{\sin T(x-x')}{x-x'} dx = \frac{1}{\pi} \underbrace{\int_{-\infty}^{\infty} \frac{\sin y}{y} dy}_{=\pi} = 1.$$

Figure 7.3 shows that $D_T(x - x')$ becomes more and more like the Dirac delta function as T gets larger and larger. In fact, we have

$$\delta(x - x') = \lim_{T \rightarrow \infty} \frac{1}{\pi} \frac{\sin T(x - x')}{x - x'}. \quad (7.21)$$

To see this, we note that for any finite T we can write

$$D_T(x - x') = \frac{T}{\pi} \frac{\sin T(x - x')}{T(x - x')}.$$

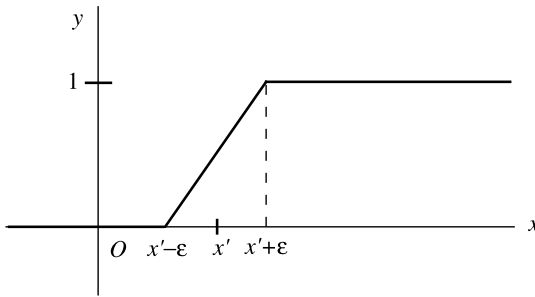

Fig. 7.4 The step function, or θ -function, shown in the figure has the Dirac delta function as its derivative

Furthermore, for values of x that are very close to x' ,

$$T(x - x') \rightarrow 0 \quad \text{and} \quad \frac{\sin T(x - x')}{T(x - x')} \rightarrow 1.$$

Thus, for such values of x and x' , we have $D_T(x - x') \approx (T/\pi)$, which is large when T is large. This is as expected of a delta function: $\delta(0) = \infty$. On the other hand, the width of $D_T(x - x')$ around x' is given, roughly, by the distance between the points at which $D_T(x - x')$ drops to zero: $T(x - x') = \pm\pi$, or $x - x' = \pm\pi/T$. This width is roughly $\Delta x = 2\pi/T$, which goes to zero as T grows. Again, this is as expected of the delta function.

The preceding example suggests another representation of the Dirac delta function:

$$\delta(x - x') = \frac{1}{2\pi} \int_{-\infty}^{\infty} e^{i(x-x')t} dt. \tag{7.22}$$

Example 7.3.3 A third representation of the Dirac delta function involves the **step function** $\theta(x - x')$, which is defined as step function or θ function

$$\theta(x - x') \equiv \begin{cases} 0 & \text{if } x < x', \\ 1 & \text{if } x > x' \end{cases}$$

and is discontinuous at $x = x'$. We can approximate this step function by a variety of continuous functions. One such function is $T_\epsilon(x - x')$ defined by

$$T_\epsilon(x - x') \equiv \begin{cases} 0 & \text{if } x \leq x' - \epsilon, \\ \frac{1}{2\epsilon}(x - x' + \epsilon) & \text{if } x' - \epsilon \leq x \leq x' + \epsilon, \\ 1 & \text{if } x \geq x' + \epsilon, \end{cases}$$

where ϵ is a small positive number as shown in Fig. 7.4. It is clear that

$$\theta(x - x') = \lim_{\epsilon \rightarrow 0} T_\epsilon(x - x').$$

Now let us consider the derivative of $T_\epsilon(x - x')$ with respect to x :

$$\frac{dT_\epsilon}{dx}(x - x') = \begin{cases} 0 & \text{if } x < x' - \epsilon, \\ \frac{1}{2\epsilon} & \text{if } x' - \epsilon < x < x' + \epsilon, \\ 0 & \text{if } x > x' + \epsilon. \end{cases}$$

We note that the derivative is not defined at $x = x' - \epsilon$ and $x = x' + \epsilon$, and that dT_ϵ/dx is zero everywhere except when x lies in the interval $(x' - \epsilon, x' + \epsilon)$, where it is equal to $1/(2\epsilon)$ and goes to infinity as $\epsilon \rightarrow 0$. Here again we see signs of the delta function. In fact, we also note that

$$\int_{-\infty}^{\infty} \left(\frac{dT_\epsilon}{dx} \right) dx = \int_{x' - \epsilon}^{x' + \epsilon} \left(\frac{dT_\epsilon}{dx} \right) dx = \int_{x' - \epsilon}^{x' + \epsilon} \frac{1}{2\epsilon} dx = 1.$$

It is not surprising, then, to find that $\lim_{\epsilon \rightarrow 0} \frac{dT_\epsilon}{dx}(x - x') = \delta(x - x')$. Assuming that the interchange of the order of differentiation and the limiting process is justified, we obtain the important identity

δ function as derivative
of θ function

$$\frac{d}{dx}\theta(x - x') = \delta(x - x'). \quad (7.23)$$

Now that we have some understanding of one continuous index, we can generalize the results to several continuous indices. In the earlier discussion we looked at $f(x)$ as the x th component of some abstract vector $|f\rangle$. For functions of n variables, we can think of $f(x_1, \dots, x_n)$ as the component of an abstract vector $|f\rangle$ along a basis vector $|x_1, \dots, x_n\rangle$.⁵ This basis is a direct generalization of one continuous index to n . Then $f(x_1, \dots, x_n)$ is defined as $f(x_1, \dots, x_n) = \langle x_1, \dots, x_n | f \rangle$. If the region of integration is denoted by Ω , and we use the abbreviations

$$\mathbf{r} \equiv (x_1, x_2, \dots, x_n), \quad d^n x = dx_1 dx_2 \dots dx_n,$$

$$|x_1, x_2, \dots, x_n\rangle = |\mathbf{r}\rangle, \quad \delta(x_1 - x'_1) \dots \delta(x_n - x'_n) = \delta(\mathbf{r} - \mathbf{r}'),$$

then we can write

$$\begin{aligned} |f\rangle &= \int_{\Omega} d^n x f(\mathbf{r}) w(\mathbf{r}) |\mathbf{r}\rangle, & \int_{\Omega} d^n x |\mathbf{r}\rangle w(\mathbf{r}) \langle \mathbf{r} | &= \mathbf{1}, \\ f(\mathbf{r}') &= \int_{\Omega} d^n x f(\mathbf{r}) w(\mathbf{r}) \langle \mathbf{r}' | \mathbf{r} \rangle, & \langle \mathbf{r}' | \mathbf{r} \rangle w(\mathbf{r}) &= \delta(\mathbf{r} - \mathbf{r}'), \end{aligned} \quad (7.24)$$

where $d^n x$ is the “volume” element and Ω is the region of integration of interest.

For instance, if the region of definition of the functions under consideration is the surface of the unit sphere, then [with $w(\mathbf{r}) = 1$], one gets

$$\int_0^{2\pi} d\phi \int_0^\pi \sin\theta d\theta |\theta, \phi\rangle \langle \theta, \phi | = \mathbf{1}. \quad (7.25)$$

⁵Do not confuse this with an n -dimensional vector. In fact, the dimension is n -fold infinite: each x_i counts one infinite set of numbers!

This will be used in our discussion of spherical harmonics in Chap. 13.

An important identity using the three-dimensional Dirac delta function comes from potential theory. This is (see [Hass 08] for a discussion of this equation)

$$\nabla^2 \left(\frac{1}{|\mathbf{r} - \mathbf{r}'|} \right) = -4\pi \delta(\mathbf{r} - \mathbf{r}'). \quad (7.26)$$

7.4 Generalized Functions

Paul Adrian Maurice Dirac discovered the delta function in the late 1920s while investigating scattering problems in quantum mechanics. This “function” seemed to violate most properties of other functions known to mathematicians at the time. However, later, when mathematicians found a rigorous way of studying this and other functions similar to it, a new vista in higher mathematics opened up.

The derivative of the delta function, $\delta'(x - x')$ is such that for any ordinary function $f(x)$,

$$\int_{-\infty}^{\infty} f(x) \delta'(x - a) dx = - \int_{-\infty}^{\infty} f'(x) \delta(x - a) dx = -f'(a).$$

We can *define* $\delta'(x - a)$ by this relation. In addition, we can define the derivative of any function, including discontinuous functions, at any point (including points of discontinuity, where the usual definition of derivative fails) by this relation. That is, if $\varphi(x)$ is a “bad” function whose derivative is not defined at some point(s), and $f(x)$ is a “good” function, we can define the derivative of $\varphi(x)$ by

$$\int_{-\infty}^{\infty} f(x) \varphi'(x) dx \equiv - \int_{-\infty}^{\infty} f'(x) \varphi(x) dx.$$

The integral on the RHS is well-defined.

Functions such as the Dirac delta function and its derivatives of all orders are not functions in the traditional sense. What is common among all of them is that in most applications they appear inside an integral, and we saw in Chap. 2 that integration can be considered as a linear functional on the space of continuous functions. It is therefore natural to describe such functions in terms of linear functionals. This idea was picked up by Laurent Schwartz in the 1950s who developed it into a new branch of mathematics called **generalized functions**, or **distributions**.

A distribution is a mathematical entity that appears inside an integral in conjunction with a well-behaved **test function**—which we assume to depend on n variables—such that the result of integration is a well-defined number. Depending on the type of test function used, different kinds of distributions can be defined. If we want to include the Dirac delta function and its derivatives of all orders, then the test functions must be infinitely differentiable, that is, they must be \mathcal{C}^∞ functions on \mathbb{R}^n (or \mathbb{C}^n). Moreover, in

test function

order for the theory of distributions to be mathematically feasible, all the test functions must be of **compact support**, i.e., they must vanish outside a finite “volume” of \mathbb{R}^n (or \mathbb{C}^n). One common notation for such functions is $\mathcal{C}_F^\infty(\mathbb{R}^n)$ or $\mathcal{C}_F^\infty(\mathbb{C}^n)$ (F stands for “finite”). The definitive property of distributions concerns the way they combine with test functions to give a number. The test functions used clearly form a vector space over \mathbb{R} or \mathbb{C} . In this vector-space language, distributions are linear functionals. The linearity is a simple consequence of the properties of the integral. We therefore have the following definition of a distribution.

generalized functions and distributions defined **Definition 7.4.1** A **distribution**, or **generalized function**, is a continuous⁶ linear functional on the space $\mathcal{C}_F^\infty(\mathbb{R}^n)$ or $\mathcal{C}_F^\infty(\mathbb{C}^n)$. If $f \in \mathcal{C}_F^\infty$ and φ is a distribution, then $\varphi[f] = \int_{-\infty}^{\infty} \varphi(\mathbf{r}) f(\mathbf{r}) d^n x$.

Another notation used in place of $\varphi[f]$ is $\langle \varphi, f \rangle$. This is more appealing not only because φ is linear, in the sense that $\varphi[\alpha f + \beta g] = \alpha \varphi[f] + \beta \varphi[g]$, but also because the set of all such linear functionals forms a vector space; that is, the linear combination of the φ 's is also defined. Thus, $\langle \varphi, f \rangle$ suggests a mutual “democracy” for both f 's and φ 's.

We now have a shorthand way of writing integrals. For instance, if δ_a represents the Dirac delta function $\delta(x - a)$, with an integration over x understood, then $\langle \delta_a, f \rangle = f(a)$. Similarly, $\langle \delta'_a, f \rangle = -f'(a)$, and for linear combinations, $\langle \alpha \delta_a + \beta \delta'_a, f \rangle = \alpha f(a) - \beta f'(a)$.

Example 7.4.2 An ordinary (continuous) function g can be thought of as a special case of a distribution. The linear functional $g : \mathcal{C}_F^\infty(\mathbb{R}) \rightarrow \mathbb{R}$ is simply defined by $\langle g, f \rangle \equiv g[f] = \int_{-\infty}^{\infty} g(x) f(x) dx$.

Example 7.4.3 An interesting application of distributions (generalized functions) occurs when the notion of density is generalized to include not only (smooth) volume densities, but also point-like, linear, and surface densities.

A point charge q located at \mathbf{r}_0 can be thought of as having a charge density $\rho(\mathbf{r}) = q \delta(\mathbf{r} - \mathbf{r}_0)$. In the language of linear functionals, we interpret ρ as a distribution, $\rho : \mathcal{C}_F^\infty(\mathbb{R}^3) \rightarrow \mathbb{R}$, which for an arbitrary function f gives

$$\rho[f] = \langle \rho, f \rangle = q f(\mathbf{r}_0). \quad (7.27)$$

The delta function character of ρ can be detected from this equation by recalling that the LHS is

$$\int \rho(\mathbf{r}) f(\mathbf{r}) d^3 x = \lim_{\substack{N \rightarrow \infty \\ \Delta V_i \rightarrow 0}} \sum_{i=1}^N \rho(\mathbf{r}_i) f(\mathbf{r}_i) \Delta V_i.$$

⁶See [Zeid 95, pp. 27, 156–160] for a formal definition of continuity for linear functionals.

On the RHS of this equation, the only volume element that contributes is the one that contains the point \mathbf{r}_0 ; all the rest contribute zero. As $\Delta V_i \rightarrow 0$, the only way that the RHS can give a nonzero number is for $\rho(\mathbf{r}_0)f(\mathbf{r}_0)$ to be infinite. Since f is a well-behaved function, $\rho(\mathbf{r}_0)$ must be infinite, implying that $\rho(\mathbf{r})$ acts as a delta function. This shows that the definition of Eq. (7.27) leads to a delta-function behavior for ρ . Similarly for linear and surface densities.

The example above and Problems 7.12 and 7.13 suggest that a distribution that confines an integral to a lower-dimensional space must have a delta function in its definition.

We have seen that the delta function can be thought of as the limit of an ordinary function. This idea can be generalized.

Definition 7.4.4 Let $\{\varphi_n(x)\}$ be a sequence of functions such that

$$\lim_{n \rightarrow \infty} \int_{-\infty}^{\infty} \varphi_n(x) f(x) dx$$

exists for all $f \in \mathcal{C}_F^\infty(\mathbb{R})$. Then the sequence is said to converge to the distribution φ , defined by

$$\langle \varphi, f \rangle = \lim_{n \rightarrow \infty} \int_{-\infty}^{\infty} \varphi_n(x) f(x) dx \quad \forall f.$$

This convergence is denoted by $\varphi_n \rightarrow \varphi$.

For example, it can be verified that

$$\frac{n}{\sqrt{\pi}} e^{-n^2 x^2} \rightarrow \delta(x) \quad \text{and} \quad \frac{1 - \cos nx}{n\pi x^2} \rightarrow \delta(x)$$

and so on. The proofs are left as exercises.

Historical Notes

“Physical Laws should have mathematical beauty.” This statement was Dirac’s response to the question of his philosophy of physics, posed to him in Moscow in 1955. He wrote it on a blackboard that is still preserved today.

Paul Adrien Maurice Dirac (1902–1984), was born in 1902 in Bristol, England, of a Swiss, French-speaking father and an English mother. His father, a taciturn man who refused to receive friends at home, enforced young Paul’s silence by requiring that only French be spoken at the dinner table. Perhaps this explains Dirac’s later disinclination toward collaboration and his general tendency to be a loner in most aspects of his life. The fundamental nature of his work made the involvement of students difficult, so perhaps Dirac’s personality was well-suited to his extraordinary accomplishments.

Dirac went to Merchant Venturer’s School, the public school where his father taught French, and while there displayed great mathematical abilities. Upon graduation, he followed in his older brother’s footsteps and went to Bristol University to study electrical engineering. He was 19 when he graduated Bristol University in 1921. Unable to find a suitable engineering position due to the economic recession that gripped post-World War I England, Dirac accepted a fellowship to study mathematics at Bristol University. This fellowship, together with a grant from the Department of Scientific and Industrial Research, made it possible for Dirac to go to Cambridge as a research student in 1923. At Cambridge Dirac was exposed to the experimental activities of the Cavendish Laboratory, and he became a member of the intellectual circle over which Rutherford and Fowler



Paul Adrien Maurice
Dirac 1902–1984

“The amount of theoretical ground one has to cover before being able to solve problems of real practical value is rather large, but this circumstance is an inevitable consequence of the fundamental part played by transformation theory and is likely to become more pronounced in the theoretical physics of the future.” P.A.M. Dirac (1930)

presided. He took his Ph.D. in 1926 and was elected in 1927 as a fellow. His appointment as university lecturer came in 1929. He assumed the Lucasian professorship following Joseph Larmor in 1932 and retired from it in 1969. Two years later he accepted a position at Florida State University where he lived out his remaining years. The FSU library now carries his name.

In the late 1920s the relentless march of ideas and discoveries had carried physics to a generally accepted relativistic theory of the electron. Dirac, however, was dissatisfied with the prevailing ideas and, somewhat in isolation, sought for a better formulation. By 1928 he succeeded in finding an equation, the *Dirac equation*, that accorded with his own ideas and also fit most of the established principles of the time. Ultimately, this equation, and the physical theory behind it, proved to be one of the great intellectual achievements of the period. It was particularly remarkable for the internal beauty of its mathematical structure, which not only clarified previously mysterious phenomena such as **spin** and the **Fermi-Dirac** statistics associated with it, but also predicted the existence of an electron-like particle of negative energy, the antielectron, or *positron*, and, more recently, it has come to play a role of great importance in modern mathematics, particularly in the interrelations between topology, geometry, and analysis. Heisenberg characterized the discovery of antimatter by Dirac as “the most decisive discovery in connection with the properties or the nature of elementary particles. . . . This discovery of particles and antiparticles by Dirac . . . changed our whole outlook on atomic physics completely.” One of the interesting implications of his work that predicted the positron was the prediction of a *magnetic monopole*. Dirac won the Nobel Prize in 1933 for this work.

Dirac is not only one of the chief authors of quantum mechanics, but he is also the creator of *quantum electrodynamics* and one of the principal architects of *quantum field theory*. While studying the scattering theory of quantum particles, he invented the (Dirac) *delta function*; in his attempt at quantizing the general theory of relativity, he founded *constrained Hamiltonian dynamics*, which is one of the most active areas of theoretical physics research today. One of his greatest contributions is the invention of *bra* $\langle |$ and *ket* $| \rangle$.

While at Cambridge, Dirac did not accept many research students. Those who worked with him generally thought that he was a good supervisor, but one who did not spend much time with his students. A student needed to be extremely independent to work under Dirac. One such student was Dennis Sciama, who later became the supervisor of Stephen Hawking, the current holder of the Lucasian chair. Salam and Wigner, in their preface to the Festschrift that honors Dirac on his seventieth birthday and commemorates his contributions to quantum mechanics succinctly assessed the man:

Dirac is one of the chief creators of quantum mechanics. . . . Posterity will rate Dirac as one of the greatest physicists of all time. The present generation values him as one of its greatest teachers. . . . On those privileged to know him, Dirac has left his mark . . . by his human greatness. He is modest, affectionate, and sets the highest possible standards of personal and scientific integrity. He is a legend in his own lifetime and rightly so.

(Taken from Schweber, S.S. “Some chapters for a history of quantum field theory: 1938-1952”, in *Relativity, Groups, and Topology II* vol. 2, B.S. DeWitt and R. Stora, eds., North-Holland, Amsterdam, 1984.)

derivative of a distribution **Definition 7.4.5** The **derivative** of a distribution φ is another distribution φ' defined by $\langle \varphi', f \rangle = -\langle \varphi, f' \rangle \forall f \in \mathcal{C}_F^\infty$.

Example 7.4.6 We can combine the last two definitions to show that if the functions θ_n are defined as

$$\theta_n(x) \equiv \begin{cases} 0 & \text{if } x \leq -\frac{1}{n}, \\ (nx + 1)/2 & \text{if } -\frac{1}{n} \leq x \leq \frac{1}{n}, \\ 1 & \text{if } x \geq \frac{1}{n}, \end{cases}$$

then $\theta'_n(x) \rightarrow \delta(x)$.

We write the definition of the derivative, $\langle \theta'_n, f \rangle = -\langle \theta_n, f' \rangle$, in terms of integrals:

$$\begin{aligned}
 & \int_{-\infty}^{\infty} \theta'_n(x) f(x) dx \\
 &= - \int_{-\infty}^{\infty} \theta_n(x) \frac{df}{dx} dx = - \int_{-\infty}^{\infty} \theta_n(x) df \\
 &= - \left(\int_{-\infty}^{-1/n} \theta_n(x) df + \int_{-1/n}^{1/n} \theta_n(x) df + \int_{1/n}^{\infty} \theta_n(x) df \right) \\
 &= - \left(0 + \int_{-1/n}^{1/n} \frac{nx+1}{2} df + \int_{1/n}^{\infty} df \right) \\
 &= - \frac{n}{2} \int_{-1/n}^{1/n} x df - \frac{1}{2} \int_{-1/n}^{1/n} df - \int_{1/n}^{\infty} df \\
 &= - \frac{n}{2} \left(x f(x) \Big|_{-1/n}^{1/n} - \int_{-1/n}^{1/n} f(x) dx \right) \\
 &\quad - \frac{1}{2} (f(1/n) - f(-1/n)) - f(\infty) + f(1/n).
 \end{aligned}$$

For large n , we have $1/n \approx 0$ and $f(\pm 1/n) \approx f(0)$. Thus,

$$\begin{aligned}
 \int_{-\infty}^{\infty} \theta'_n(x) f(x) dx &\approx - \frac{n}{2} \left(\frac{1}{n} f\left(\frac{1}{n}\right) + \frac{1}{n} f\left(-\frac{1}{n}\right) - \frac{2}{n} f(0) \right) + f(0) \\
 &\approx f(0).
 \end{aligned}$$

The approximation becomes equality in the limit $n \rightarrow \infty$. Thus,

$$\lim_{n \rightarrow \infty} \int_{-\infty}^{\infty} \theta'_n(x) f(x) dx = f(0) = \langle \delta_0, f \rangle \Rightarrow \theta'_n \rightarrow \delta.$$

Note that $f(\infty) = 0$ because of the assumption that all functions must vanish outside a finite volume.

7.5 Problems

7.1 Show that $\| \|a\| - \|b\| \| \leq \|a \pm b\| \leq \|a\| + \|b\|$.

7.2 Show that a convergent sequence is necessarily Cauchy.

7.3 Verify that the sequence of functions $\{f_k(x)\}$ defined in Example 7.1.5 is a Cauchy sequence.

7.4 Prove the completeness of \mathbb{C} , using the completeness of \mathbb{R} .

7.5 Let $\mathcal{L}^1(\mathbb{R})$ be the set of all functions f such that $\|f\| \equiv \int_{-\infty}^{\infty} |f(x)| dx$ is finite. This is clearly a normed vector space. Let f and g be nonzero functions such that at no x are $f(x)$ and $g(x)$ both nonzero. Verify that

- (a) $\|f \pm g\| = \|f\| + \|g\|$.
- (b) $\|f + g\|^2 + \|f - g\|^2 = 2(\|f\| + \|g\|)^2$.
- (c) Using parts (a), (b), and Theorem 2.2.9, show that $\mathcal{L}^1(\mathbb{R})$ is not an inner product space.

This construction shows that not all norms arise from an inner product.

7.6 Use Eq. (7.10) to derive Eq. (7.12). Hint: To find a_n , equate the coefficients of x^n on both sides of Eq. (7.10). To find a_{n-1} , multiply both sides of Eq. (7.10) by $C_{n-1}w(x)$ and integrate, using the definitions of $k_n^{(n)}$, $k_n^{(n-1)}$, and h_n .

7.7 Evaluate the integral $\int_a^b x^2 C_m(x) C_n(x) w(x) dx$.

7.8 Write a density function for two point charges q_1 and q_2 located at $\mathbf{r} = \mathbf{r}_1$ and $\mathbf{r} = \mathbf{r}_2$, respectively.

7.9 Write a density function for four point charges $q_1 = q$, $q_2 = -q$, $q_3 = q$ and $q_4 = -q$, located at the corners of a square of side $2a$, lying in the xy -plane, whose center is at the origin and whose first corner is at (a, a) .

7.10 Show that $\delta(f(x)) = \frac{1}{|f'(x_0)|} \delta(x - x_0)$, where x_0 is a root of f and x is confined to values close to x_0 . Hint: Make a change of variable to $y = f(x)$.

7.11 Show that

$$\delta(f(x)) = \sum_{k=1}^m \frac{1}{|f'(x_k)|} \delta(x - x_k),$$

where the x_k 's are all the roots of f in the interval on which f is defined.

7.12 Define the distribution $\rho : \mathcal{C}^\infty(\mathbb{R}^3) \rightarrow \mathbb{R}$ by

$$\langle \rho, f \rangle = \iint_S \sigma(\mathbf{r}) f(\mathbf{r}) da(\mathbf{r}),$$

where $\sigma(\mathbf{r})$ is a smooth function on a smooth surface S in \mathbb{R}^3 . Show that $\rho(\mathbf{r})$ is zero if \mathbf{r} is not on S and infinite if \mathbf{r} is on S .

7.13 Define the distribution $\rho : \mathcal{C}^\infty(\mathbb{R}^3) \rightarrow \mathbb{R}$ by

$$\langle \rho, f \rangle = \int_C \lambda(\mathbf{r}) f(\mathbf{r}) d\ell(\mathbf{r}),$$

where $\lambda(\mathbf{r})$ is a smooth function on a smooth curve C in \mathbb{R}^3 . Show that $\rho(\mathbf{r})$ is zero if \mathbf{r} is not on C and infinite if \mathbf{r} is on C .

7.14 Express the three-dimensional Dirac delta function as a product of three one-dimensional delta functions involving the coordinates in

- (a) cylindrical coordinates,
- (b) spherical coordinates,
- (c) general curvilinear coordinates.

Hint: The Dirac delta function in \mathbb{R}^3 satisfies $\iiint \delta(\mathbf{r}) d^3x = 1$.

7.15 Show that $\int_{-\infty}^{\infty} \delta'(x) f(x) dx = -f'(0)$ where $\delta'(x) \equiv \frac{d}{dx} \delta(x)$.

7.16 Evaluate the following integrals:

- (a) $\int_{-\infty}^{\infty} \delta(x^2 - 5x + 6)(3x^2 - 7x + 2) dx.$
- (b) $\int_{-\infty}^{\infty} \delta(x^2 - \pi^2) \cos x dx.$
- (c) $\int_{0.5}^{\infty} \delta(\sin \pi x) \left(\frac{2}{3}\right)^x dx.$
- (d) $\int_{-\infty}^{\infty} \delta(e^{-x^2}) \ln x dx.$

Hint: Use the result of Problem 7.11.

7.17 Consider $|x|$ as a generalized function and find its derivative.

7.18 Let $\eta \in \mathcal{C}^\infty(\mathbb{R}^n)$ be a smooth function on \mathbb{R}^n , and let φ be a distribution. Show that $\eta\varphi$ is also a distribution. What is the natural definition for $\eta\varphi$? What is $(\eta\varphi)'$, the derivative of $\eta\varphi$?

7.19 Show that each of the following sequences of functions approaches $\delta(x)$ in the sense of Definition 7.4.4.

- (a) $\frac{n}{\sqrt{\pi}} e^{-n^2 x^2}.$
- (b) $\frac{1 - \cos nx}{\pi n x^2}.$
- (c) $\frac{n}{\pi} \frac{1}{1 + n^2 x^2}.$
- (d) $\frac{\sin nx}{\pi x}.$

Hint: Approximate $\varphi_n(x)$ for large n and $x \approx 0$, and then evaluate the appropriate integral.

7.20 Show that $\frac{1}{2}(1 + \tanh nx) \rightarrow \theta(x)$ as $n \rightarrow \infty$.

7.21 Show that $x\delta'(x) = -\delta(x)$.

Example 7.2.5 discussed only one of the many types of the so-called classical orthogonal polynomials. Historically, these polynomials were discovered as solutions to differential equations arising in various physical problems. Such polynomials can be produced by starting with $1, x, x^2, \dots$ and employing the Gram-Schmidt process. However, there is a more elegant, albeit less general, approach that simultaneously studies most polynomials of interest to physicists. We will employ this approach.¹

8.1 General Properties

Most relevant properties of the polynomials of interest are contained in

Theorem 8.1.1 *Consider the functions*

$$F_n(x) = \frac{1}{w(x)} \frac{d^n}{dx^n} (ws^n) \quad \text{for } n = 0, 1, 2, \dots, \quad (8.1)$$

where

1. $F_1(x)$ is a first-degree polynomial in x ,
2. $s(x)$ is a polynomial in x of degree less than or equal to 2 with only real roots,
3. $w(x)$ is a strictly positive function, integrable in the interval (a, b) , that satisfies the boundary conditions $w(a)s(a) = 0 = w(b)s(b)$.

Then $F_n(x)$ is a polynomial of degree n in x and is orthogonal—on the interval (a, b) , with weight $w(x)$ —to any polynomial $p_k(x)$ of degree $k < n$, i.e.,

$$\int_a^b p_k(x) F_n(x) w(x) dx = 0 \quad \text{for } k < n.$$

These polynomials are collectively called **classical orthogonal polynomials**.

¹This approach is due to F.G. Tricomi [Tric 55]. See also [Denn 67].

Before proving the theorem, we need two lemmas:²

Lemma 8.1.2 *The following identity holds:*

$$\frac{d^m}{dx^m}(ws^n p_{\leq k}) = ws^{n-m} p_{\leq k+m}, \quad m \leq n.$$

Proof See Problem 8.1. □

Lemma 8.1.3 *All the derivatives $d^m/dx^m(ws^n)$ vanish at $x = a$ and $x = b$, for all values of $m < n$.*

Proof Set $k = 0$ in the identity of the previous lemma and let $p_{\leq 0} = 1$. Then we have $\frac{d^m}{dx^m}(ws^n) = ws^{n-m} p_{\leq m}$. The RHS vanishes at $x = a$ and $x = b$ due to the third condition stated in the theorem. □

Proof of the theorem We prove the orthogonality first. The proof involves multiple use of integration by parts:

$$\begin{aligned} \int_a^b p_k(x) F_n(x) w(x) dx &= \int_a^b p_k(x) \frac{1}{w} \left[\frac{d^n}{dx^n}(ws^n) \right] w dx \\ &= \int_a^b p_k(x) \frac{d}{dx} \left[\frac{d^{n-1}}{dx^{n-1}}(ws^n) \right] dx \\ &= p_k(x) \underbrace{\frac{d^{n-1}}{dx^{n-1}}(ws^n)}_{=0 \text{ by Lemma 8.1.3}} \Big|_a^b \\ &\quad - \int_a^b \frac{dp_k}{dx} \frac{d^{n-1}}{dx^{n-1}}(ws^n) dx. \end{aligned}$$

This shows that each integration by parts transfers one differentiation from ws^n to p_k and introduces a minus sign. Thus, after k integrations by parts, we get

$$\begin{aligned} \int_a^b p_k(x) F_n(x) w(x) dx &= (-1)^k \int_a^b \frac{d^k p_k}{dx^k} \frac{d^{n-k}}{dx^{n-k}}(ws^n) dx \\ &= C \int_a^b \frac{d}{dx} \left[\frac{d^{n-k-1}}{dx^{n-k-1}}(ws^n) \right] dx \\ &= C \frac{d^{n-k-1}}{dx^{n-k-1}}(ws^n) \Big|_a^b = 0, \end{aligned}$$

where we have used the fact that the k th derivative of a polynomial of degree k is a constant. Note that $n - k - 1 \geq 0$ because $k < n$, so that the last line of the equation is well-defined. The last equality follows from Lemma 8.1.3.

²Recall that $p_{\leq k}$ is a generic polynomial with degree less than or equal to k .

To prove the first part of the theorem, we use Lemma 8.1.2 with $k = 0$, $p_{\leq 0} \equiv p_0 = 1$, and $m = n$ to get

$$\frac{d^n}{dx^n}(ws^n) = wp_{\leq n}, \quad \text{or} \quad F_n(x) = \frac{1}{w} \frac{d^n}{dx^n}(ws^n) = p_{\leq n}.$$

To prove that $F_n(x)$ is a polynomial of degree precisely equal to n , we write $F_n(x) = p_{\leq n-1}(x) + k_n^{(n)}x^n$, multiply both sides by $w(x)F_n(x)$, and integrate over (a, b) :

$$\begin{aligned} & \int_a^b [F_n(x)]^2 w(x) dx \\ &= \int_a^b p_{\leq n-1} F_n(x) w(x) dx + k_n^{(n)} \int_a^b x^n F_n(x) w(x) dx. \end{aligned}$$

The LHS is a positive quantity because both $w(x)$ and $[F_n(x)]^2$ are positive, and the first integral on the RHS vanishes by the first part of the proof. Therefore, the second term on the RHS cannot be zero. In particular, $k_n^{(n)} \neq 0$, and $F_n(x)$ is of degree n . □

It is customary to introduce a normalization constant in the definition of $F_n(x)$, and write

$$F_n(x) = \frac{1}{K_n w} \frac{d^n}{dx^n}(ws^n). \tag{8.2}$$

This equation is called the **generalized Rodriguez formula**. For historical reasons, different polynomial functions are normalized differently, which is why K_n is introduced here.

generalized Rodriguez formula

From Theorem 8.1.1 it is clear that the sequence $\{F_n(x)\}_{n=0}^\infty$ forms an orthogonal set of polynomials on $[a, b]$ with weight function $w(x)$.

All the varieties of classical orthogonal polynomials were discovered as solutions of differential equations. Here, we give a single generic differential equation satisfied by all the F_n 's. The proof is outlined in Problem 8.4.

differential equation for classical orthogonal polynomials

Proposition 8.1.4 *Let $k_1^{(1)}$ be the coefficient of x in $F_1(x)$ and σ_2 the coefficient of x^2 in $s(x)$. Then the orthogonal polynomials F_n satisfy the differential equation*

$$\frac{d}{dx} \left(ws \frac{dF_n}{dx} \right) = w \lambda_n F_n(x) \quad \text{where} \quad \lambda_n = K_1 k_1^{(1)} n + \sigma_2 n(n-1).$$

We shall study the differential equation above in the context of the Sturm-Liouville problem (see Chap. 19), which is an eigenvalue problem involving differential operators.

8.2 Classification

Let us now investigate the consequences of various choices of $s(x)$. We start with $F_1(x)$, and note that it satisfies Eq. (8.2) with $n = 1$:

$$F_1(x) = \frac{1}{K_1 w} \frac{d}{dx}(ws), \quad \text{or} \quad \frac{1}{ws} \frac{d}{dx}(ws) = \frac{K_1 F_1(x)}{s},$$

which can be integrated to yield $ws = A \exp(\int K_1 F_1(x) dx/s)$ where A is a constant. On the other hand, being a polynomial of degree 1, $F_1(x)$ can be written as $F_1(x) = k_1^{(1)}x + k_1^{(0)}$. It follows that

$$w(x)s(x) = A \exp\left(\int \frac{K_1(k_1^{(1)}x + k_1^{(0)})}{s} dx\right), \quad (8.3)$$

$$w(a)s(a) = 0 = w(b)s(b).$$

Next we look at the three choices for $s(x)$: a constant, a polynomial of degree 1, and a polynomial of degree 2. For a constant $s(x)$, Eq. (8.3) can be easily integrated:

$$w(x)s(x) = A \exp\left(\int \frac{K_1(k_1^{(1)}x + k_1^{(0)})}{s} dx\right) \equiv A \exp\left(\int (2\alpha x + \beta) dx\right)$$

$$= A e^{\alpha x^2 + \beta x + C} = B e^{\alpha x^2 + \beta x},$$

$$2\alpha \equiv K_1 k_1^{(1)}/s, \quad \beta \equiv K_1 k_1^{(0)}/s, \quad B \equiv A e^C.$$

The interval (a, b) is determined by $w(a)s(a) = 0 = w(b)s(b)$, which yields

$$B e^{\alpha a^2 + \beta a} = 0 = B e^{\alpha b^2 + \beta b}.$$

For nonzero B , the only way that this equality can hold is for α to be negative and for a and b to be infinite. Since $a < b$, we must take $a = -\infty$ and $b = +\infty$. With $y = \sqrt{|\alpha|}(x + \beta/(2\alpha))$ and choosing $B = s \exp(\beta^2/(4\alpha))$, we obtain $w(y) = \exp(-y^2)$. We also take the constant s to be 1. This is always possible by a proper choice of constants such as B .

If the degree of s is 1, then $s(x) = \sigma_1 x + \sigma_0$ and

$$w(x)(\sigma_1 x + \sigma_0) = A \exp\left(\int \frac{K_1(k_1^{(1)}x + k_1^{(0)})}{\sigma_1 x + \sigma_0} dx\right)$$

$$= A \exp\left[\int \left(\frac{K_1 k_1^{(1)}}{\sigma_1} + \frac{K_1 k_1^{(0)} - K_1 k_1^{(1)} \sigma_0 / \sigma_1}{\sigma_1 x + \sigma_0}\right) dx\right]$$

$$\equiv B(\sigma_1 x + \sigma_0)^\rho e^{\gamma x},$$

where $\gamma = K_1 k_1^{(1)}/\sigma_1$, $\rho = K_1 k_1^{(0)}/\sigma_1 - K_1 k_1^{(1)} \sigma_0 / \sigma_1^2$, and B is A modified by the constant of integration. The last equation above must satisfy the boundary conditions at a and b :

$$B(\sigma_1 a + \sigma_0)^\rho e^{\gamma a} = 0 = B(\sigma_1 b + \sigma_0)^\rho e^{\gamma b},$$

Table 8.1 Special cases of Jacobi polynomials

| μ | ν | $w(x)$ | Polynomial |
|-------------------------|-------------------------|---------------------------|---|
| 0 | 0 | 1 | Legendre, $P_n(x)$ |
| $\lambda - \frac{1}{2}$ | $\lambda - \frac{1}{2}$ | $(1 - x^2)^{\lambda-1/2}$ | Gegenbauer, $C_n^\lambda(x)$, $\lambda > -\frac{1}{2}$ |
| $-\frac{1}{2}$ | $-\frac{1}{2}$ | $(1 - x^2)^{-1/2}$ | Chebyshev of the first kind, $T_n(x)$ |
| $\frac{1}{2}$ | $\frac{1}{2}$ | $(1 - x^2)^{1/2}$ | Chebyshev of the second kind, $U_n(x)$ |

which give $a = -\sigma_0/\sigma_1$, $\rho > 0$, $\gamma < 0$, and $b = +\infty$. With appropriate re-definition of variables and parameters, we can write

$$w(y) = y^\nu e^{-y}, \quad \nu > -1, \quad s(x) = x, \quad a = 0, \quad b = +\infty.$$

Similarly, we can obtain the weight function and the interval of integration for the case when $s(x)$ is of degree 2. This result, as well as the results obtained above, are collected in the following proposition.

Proposition 8.2.1 *If the conditions of Theorem 8.1.1 prevail, then*

Hermite, Laguerre, and Jacobi polynomials

- (a) *For $s(x)$ of degree zero we get $w(x) = e^{-x^2}$ with $s(x) = 1$, $a = -\infty$, and $b = +\infty$. The resulting polynomials are called **Hermite polynomials** and are denoted by $H_n(x)$.*
- (b) *For $s(x)$ of degree 1, we obtain $w(x) = x^\nu e^{-x}$ with $\nu > -1$, $s(x) = x$, $a = 0$, and $b = +\infty$. The resulting polynomials are called **Laguerre polynomials** and are denoted by $L_n^\nu(x)$.*
- (c) *For $s(x)$ of degree 2, we get $w(x) = (1 + x)^\mu(1 - x)^\nu$ with $\mu, \nu > -1$, $s(x) = 1 - x^2$, $a = -1$, and $b = +1$. The resulting polynomials are called **Jacobi polynomials** and are denoted by $P_n^{\mu,\nu}(x)$.*

Jacobi polynomials are themselves divided into other subcategories depending on the values of μ and ν . The most common and widely used of these are collected in Table 8.1. Note that the definition of each of the preceding polynomials involves a “standardization,” which boils down to a particular choice of K_n in the generalized Rodriguez formula.

8.3 Recurrence Relations

Besides the recurrence relations obtained in Sect. 7.2, we can use the differential equation of Proposition 8.1.4 to construct new recurrence relations involving derivatives. These relations apply only to *classical* orthogonal polynomials, and not to general ones. We start with Eq. (7.12)

$$F_{n+1}(x) = (\alpha_n x + \beta_n)F_n(x) + \gamma_n F_{n-1}(x), \tag{8.4}$$

differentiate both sides twice, and substitute for the second derivative from the differential equation of Proposition 8.1.4. This will yield

$$2ws\alpha_n F_n' + \left[\alpha_n \frac{d}{dx}(ws) + w\lambda_n(\alpha_n x + \beta_n) \right] F_n - w\lambda_{n+1} F_{n+1} + w\gamma_n \lambda_{n-1} F_{n-1} = 0. \quad (8.5)$$

Historical Notes



Karl Gustav Jacob Jacobi
1804–1851

Karl Gustav Jacob Jacobi (1804–1851) was the second son born to a well-to-do Jewish banking family in Potsdam. An obviously bright young man, Jacobi was soon moved to the highest class in spite of his youth and remained at the gymnasium for four years only because he could not enter the university until he was sixteen. He excelled at the University of Berlin in all the classical subjects as well as mathematical studies, the topic he soon chose as his career. He passed the examination to become a secondary school teacher, then later the examination that allowed university teaching, and joined the faculty at Berlin at the age of twenty. Since promotion there appeared unlikely, he moved in 1826 to the University of Königsberg in search of a more permanent position. He was known as a lively and creative lecturer who often injected his latest research topics into the lectures. He began what is now a common practice at most universities—the research seminar—for the most advanced students and his faculty collaborators. The Jacobi “school”, together with the influence of Bessel and Neumann (also at Königsberg), sparked a renewal of mathematical excellence in Germany.

In 1843 Jacobi fell gravely ill with diabetes. After seeing his condition, Dirichlet, with the help of von Humboldt, secured a donation to enable Jacobi to spend several months in Italy, a therapy recommended by his doctor. The friendly atmosphere and healthful climate there soon improved his condition. Jacobi was later given royal permission to move from Königsberg to Berlin so that his health would not be affected by the harsh winters in the former location. A salary bonus given to Jacobi to offset the higher cost of living in the capital was revoked after he made some politically sensitive remarks in an impromptu speech. A permanent position at Berlin was also refused, and the reduced salary and lack of security caused considerable hardship for Jacobi and his family. Only after he accepted a position in Vienna did the Prussian government recognize the desirability of keeping the distinguished mathematician within its borders, offering him special concessions that together with his love for his homeland convinced Jacobi to stay. In 1851 Jacobi died after contracting both influenza and smallpox.

Jacobi’s mathematical reputation began largely with his heated competition with Abel in the study of elliptic functions. Legendre, formerly the star of such studies, wrote Jacobi of his happiness at having “lived long enough to witness these magnanimous contests between two young athletes equally strong”. Although Jacobi and Abel could reasonably be considered contemporary researchers who arrived at many of the same results independently, Jacobi suggested the names “Abelian functions” and “Abelian theorem” in a review he wrote for Crelle’s Journal. Jacobi also extended his discoveries in elliptic functions to number theory and the theory of integration. He also worked in other areas of number theory, such as the theory of quadratic forms and the representation of integers as sums of squares and cubes. He presented the well-known *Jacobian*, or functional determinant, in 1841. To physicists, Jacobi is probably best known for his work in dynamics with the form introduced by Hamilton. Although elegant and quite general, Hamiltonian dynamics did not lend itself to easy solution of many practical problems in mechanics. In the spirit of Lagrange, Poisson, and others, Jacobi investigated transformations of Hamilton’s equations that preserved their canonical nature (loosely speaking, that preserved the Poisson brackets in each representation). After much work and a little simplification, the resulting equations of motion, now known as *Hamilton-Jacobi equations*, allowed Jacobi to solve several important problems in ordinary and celestial mechanics. Clebsch and later Helmholtz amplified their use in other areas of physics.

We can get another recurrence relation involving derivatives by substituting (8.4) in (8.5) and simplifying:

$$2ws\alpha_n F'_n + \left[\alpha_n \frac{d}{dx}(ws) + w(\lambda_n - \lambda_{n+1})(\alpha_n x + \beta_n) \right] F_n + w\gamma_n(\lambda_{n-1} - \lambda_{n+1})F_{n-1} = 0. \quad (8.6)$$

Two other recurrence relations can be obtained by differentiating equations (8.6) and (8.5), respectively, and using the differential equation for F_n . Now solve the first equation so obtained for $\gamma_n(d/dx)(wF_{n-1})$ and substitute the result in the second equation. After simplification, the result will be

$$2w\alpha_n\lambda_n F_n + \frac{d}{dx} \left\{ \left[\alpha_n \frac{d}{dx}(ws) + w(\lambda_n - \lambda_{n-1})(\alpha_n x + \beta_n) \right] F_n \right\} + (\lambda_{n-1} - \lambda_{n+1}) \frac{d}{dx}(wF_{n+1}) = 0. \quad (8.7)$$

Finally, we record one more useful recurrence relation:

$$A_n(x)F_n - \lambda_{n+1}(\alpha_n x + \beta_n) \frac{dw}{dx} F_{n+1} + \gamma_n \lambda_{n-1}(\alpha_n x + \beta_n) \frac{dw}{dx} F_{n-1} + B_n(x)F'_{n+1} + \gamma_n D_n(x)F'_{n-1} = 0, \quad (8.8)$$

where

$$A_n(x) = (\alpha_n x + \beta_n) \left[2w\alpha_n\lambda_n + \alpha_n \frac{d^2}{dx^2}(ws) + \lambda_n(\alpha_n x + \beta_n) \frac{dw}{dx} \right] - \alpha_n^2 \frac{d}{dx}(ws),$$

$$B_n(x) = \alpha_n \frac{d}{dx}(ws) - w(\alpha_n x + \beta_n)(\lambda_{n+1} - \lambda_n),$$

$$D_n(x) = w(\alpha_n x + \beta_n)(\lambda_{n-1} - \lambda_n) - \alpha_n \frac{d}{dx}(ws).$$

Details of the derivation of this relation are left for the reader. All these recurrence relations seem to be very complicated. However, complexity is the price we pay for generality. When we work with specific orthogonal polynomials, the equations simplify considerably. For instance, for Hermite and Legendre polynomials Eq. (8.6) yields, respectively,

useful recurrence relations for Hermite and Legendre polynomials

$$H'_n = 2nH_{n-1}, \quad \text{and} \quad (1-x^2)P'_n + nxP_n - nP_{n-1} = 0. \quad (8.9)$$

Also, applying Eq. (8.7) to Legendre polynomials gives

$$P'_{n+1} - xP'_n - (n+1)P_n = 0, \quad (8.10)$$

and Eq. (8.8) yields

$$P'_{n+1} - P'_{n-1} - (2n+1)P_n = 0. \quad (8.11)$$

It is possible to find many more recurrence relations by manipulating the existing recurrence relations.

Before studying specific orthogonal polynomials, let us pause for a moment to appreciate the generality and elegance of the preceding discussion. With a few assumptions and a single defining equation we have severely restricted the choice of the weight function and with it the choice of the interval (a, b) . We have nevertheless exhausted the list of the so-called classical orthogonal polynomials.

8.4 Details of Specific Examples

We now construct the specific polynomials used frequently in physics. We have seen that the four parameters $K_n, k_n^{(n)}, k_n^{(n-1)}$, and h_n determine all the properties of the polynomials. Once K_n is fixed by some standardization, we can determine all the other parameters: $k_n^{(n)}$ and $k_n^{(n-1)}$ will be given by the generalized Rodriguez formula, and h_n can be calculated as follows:

$$\begin{aligned} h_n &= \int_a^b F_n^2(x)w(x) dx = \int_a^b (k_n^{(n)}x^n + \dots)F_n(x)w(x) dx \\ &= k_n^{(n)} \int_a^b wx^n \frac{1}{K_n w} \frac{d^n}{dx^n}(ws^n) dx = \frac{k_n^{(n)}}{K_n} \int_a^b x^n \frac{d}{dx} \left[\frac{d^{n-1}}{dx^{n-1}}(ws^n) \right] dx \\ &= \frac{k_n^{(n)}}{K_n} x^n \frac{d^{n-1}}{dx^{n-1}}(ws^n) \Big|_a^b - \frac{k_n^{(n)}}{K_n} \int_a^b \frac{d}{dx}(x^n) \frac{d^{n-1}}{dx^{n-1}}(ws^n) dx. \end{aligned}$$

The first term of the last line is zero by Lemma 8.1.3. It is clear that each integration by parts introduces a minus sign and shifts one differentiation from ws^n to x^n . Thus, after n integrations by parts and noting that $d^0/dx^0(ws^n) = ws^n$ and $d^n/dx^n(x^n) = n!$, we obtain

$$h_n = \frac{(-1)^n k_n^{(n)} n!}{K_n} \int_a^b ws^n dx. \tag{8.12}$$

8.4.1 Hermite Polynomials

summary of properties of Hermite polynomials

The Hermite polynomials are standardized such that $K_n = (-1)^n$. Thus, the generalized Rodriguez formula (8.2) and Proposition 8.2.1 give

$$H_n(x) = (-1)^n e^{x^2} \frac{d^n}{dx^n}(e^{-x^2}). \tag{8.13}$$

It is clear that each time e^{-x^2} is differentiated, a factor of $-2x$ is introduced. The highest power of x is obtained when we differentiate e^{-x^2} n times. This yields $(-1)^n e^{x^2} (-2x)^n e^{-x^2} = 2^n x^n \Rightarrow k_n^{(n)} = 2^n$.

To obtain $k_n^{(n-1)}$, we find it helpful to see whether the polynomial is even or odd. We substitute $-x$ for x in Eq. (8.13) and get $H_n(-x) = (-1)^n H_n(x)$, which shows that if n is even (odd), H_n is an even (odd) polynomial, i.e., it can have only even (odd) powers of x . In either case, the

next-highest power of x in $H_n(x)$ is not $n - 1$ but $n - 2$. Thus, the coefficient of x^{n-1} is zero for $H_n(x)$, and we have $k_n^{(n-1)} = 0$. For h_n , we use (8.12) to obtain $h_n = \sqrt{\pi} 2^n n!$.

Next we calculate the recurrence relation of Eq. (7.12). We can readily calculate the constants needed: $\alpha_n = 2$, $\beta_n = 0$, $\gamma_n = -2n$. Then substitute these in Eq. (7.12) to obtain

$$H_{n+1}(x) = 2xH_n(x) - 2nH_{n-1}(x). \quad (8.14)$$

Other recurrence relations can be obtained similarly.

Finally, the differential equation of $H_n(x)$ is obtained by first noting that $K_1 = -1$, $\sigma_2 = 0$, $F_1(x) = 2x \Rightarrow k_1^{(1)} = 2$. All of this gives $\lambda_n = -2n$, which can be used in the equation of Proposition 8.1.4 to get

$$\frac{d^2 H_n}{dx^2} - 2x \frac{dH_n}{dx} + 2nH_n = 0. \quad (8.15)$$

8.4.2 Laguerre Polynomials

For Laguerre polynomials, the standardization is $K_n = n!$. Thus, the generalized Rodriguez formula (8.2) and Proposition 8.2.1 give

summary of properties
of Laguerre polynomials

$$L_n^v(x) = \frac{1}{n! x^v e^{-x}} \frac{d^n}{dx^n} (x^v e^{-x} x^n) = \frac{1}{n!} x^{-v} e^x \frac{d^n}{dx^n} (x^{n+v} e^{-x}). \quad (8.16)$$

To find $k_n^{(n)}$ we note that differentiating e^{-x} does not introduce any new powers of x but only a factor of -1 . Thus, the highest power of x is obtained by leaving x^{n+v} alone and differentiating e^{-x} n times. This gives

$$\frac{1}{n!} x^{-v} e^x x^{n+v} (-1)^n e^{-x} = \frac{(-1)^n}{n!} x^n \Rightarrow k_n^{(n)} = \frac{(-1)^n}{n!}.$$

We may try to check the evenness or oddness of $L_n^v(x)$; however, this will not be helpful because changing x to $-x$ distorts the RHS of Eq. (8.16). In fact, $k_n^{(n-1)} \neq 0$ in this case, and it can be calculated by noticing that the next-highest power of x is obtained by adding the first derivative of x^{n+v} n times and multiplying the result by $(-1)^{n-1}$, which comes from differentiating e^{-x} . We obtain

$$\frac{1}{n!} x^{-v} e^x [(-1)^{n-1} n(n+v) x^{n+v-1} e^{-x}] = \frac{(-1)^{n-1} (n+v)}{(n-1)!} x^{n-1},$$

and therefore $k_n^{(n-1)} = (-1)^{n-1} (n+v)/(n-1)!$.

Finally, for h_n we get

$$h_n = \frac{(-1)^n [(-1)^n / n!] n!}{n!} \int_0^\infty x^v e^{-x} x^n dx = \frac{1}{n!} \int_0^\infty x^{n+v} e^{-x} dx.$$

If v is not an integer (and it need not be), the integral on the RHS cannot be evaluated by elementary methods. In fact, this integral occurs so frequently in mathematical applications that it is given a special name, the **gamma**

the gamma function **function.** A detailed discussion of this function can be found in Chap. 12. At this point, we simply note that

$$\Gamma(z+1) \equiv \int_0^\infty x^z e^{-x} dx, \quad \Gamma(n+1) = n! \quad \text{for } n \in \mathbb{N}, \quad (8.17)$$

and write h_n as

$$h_n = \frac{\Gamma(n+\nu+1)}{n!} = \frac{\Gamma(n+\nu+1)}{\Gamma(n+1)}.$$

The relevant parameters for the recurrence relation can be easily calculated:

$$\alpha_n = -\frac{1}{n+1}, \quad \beta_n = \frac{2n+\nu+1}{n+1}, \quad \gamma_n = -\frac{n+\nu}{n+1}.$$

Substituting these in Eq. (7.12) and simplifying yields

$$(n+1)L_{n+1}^\nu = (2n+\nu+1-x)L_n^\nu - (n+\nu)L_{n-1}^\nu.$$

With $k_1^{(1)} = -1$ and $\sigma_2 = 0$, we get $\lambda_n = -n$, and the differential equation of Proposition 8.1.4 becomes

$$x \frac{d^2 L_n^\nu}{dx^2} + (\nu+1-x) \frac{dL_n^\nu}{dx} + nL_n^\nu = 0. \quad (8.18)$$

8.4.3 Legendre Polynomials

summary of properties of Legendre polynomials

Instead of discussing the Jacobi polynomials as a whole, we will discuss a special case of them, the Legendre polynomials $P_n(x)$, which are more widely used in physics.

With $\mu = 0 = \nu$, corresponding to the Legendre polynomials, the weight function for the Jacobi polynomials reduces to $w(x) = 1$. The standardization is $K_n = (-1)^n 2^n n!$. Thus, the generalized Rodriguez formula reads

$$P_n(x) = \frac{(-1)^n}{2^n n!} \frac{d^n}{dx^n} [(1-x^2)^n]. \quad (8.19)$$

To find $k_n^{(n)}$, we expand the expression in square brackets using the binomial theorem and take the n th derivative of the highest power of x . This yields

$$\begin{aligned} k_n^{(n)} x^n &= \frac{(-1)^n}{2^n n!} \frac{d^n}{dx^n} [(-x^2)^n] = \frac{1}{2^n n!} \frac{d^n}{dx^n} (x^{2n}) \\ &= \frac{1}{2^n n!} 2n(2n-1)(2n-2) \cdots (n+1)x^n. \end{aligned}$$

After some algebra (see Problem 8.15), we get $k_n^{(n)} = \frac{2^n \Gamma(n+\frac{1}{2})}{n! \Gamma(\frac{1}{2})}$.

Historical Notes

Adrien-Marie Legendre (1752–1833) came from a well-to-do Parisian family and received an excellent education in science and mathematics. His university work was advanced enough that his mentor used many of Legendre’s essays in a treatise on mechanics. A man of modest fortune until the revolution, Legendre was able to devote himself to study and research without recourse to an academic position. In 1782 he won the prize of the Berlin Academy for calculating the trajectories of cannonballs taking air resistance into account. This essay brought him to the attention of Lagrange and helped pave the way to acceptance in French scientific circles, notably the Academy of Sciences, to which Legendre submitted numerous papers. In July 1784 he submitted a paper on planetary orbits that contained the now-famous *Legendre polynomials*, mentioning that Lagrange had been able to “present a more complete theory” in a recent paper by using Legendre’s results. In the years that followed, Legendre concentrated his efforts in number theory, celestial mechanics, and the theory of elliptic functions. In addition, he was a prolific calculator, producing large tables of the values of special functions, and he also authored an elementary textbook that remained in use for many decades. In 1824 Legendre refused to vote for the government’s candidate for *Institut National*. Because of this, his pension was stopped and he died in poverty and in pain at the age of 80 after several years of failing health.

Legendre produced a large number of useful ideas but did not always develop them in the most rigorous manner, claiming to hold the priority for an idea if he had presented merely a reasonable argument for it. Gauss, with whom he had several quarrels over priority, considered rigorous proof the standard of ownership. To Legendre’s credit, however, he was an enthusiastic supporter of his young rivals Abel and Jacobi and gave their work considerable attention in his writings. Especially in the theory of elliptic functions, the area of competition with Abel and Jacobi, Legendre is considered more of a trailblazer than a great builder. Hermite wrote that Legendre “is considered the founder of the theory of elliptic functions” and “greatly smoothed the way for his successors”, but notes that the recognition of the double periodicity of the inverse function, which allowed the great progress of others, was missing from Legendre’s work.

Legendre also contributed to practical efforts in science and mathematics. He and two of his contemporaries were assigned in 1787 to a panel conducting geodetic work in cooperation with the observatories at Paris and Greenwich. Four years later the same panel members were appointed as the Academy’s commissioners to undertake the measurements and calculations necessary to determine the length of the standard meter. Legendre’s seemingly tireless skill at calculating produced large tables of the values of trigonometric and elliptic functions, logarithms, and solutions to various special equations.

In his famous textbook *Eléments de géométrie* (1794) he gave a simple proof that π is irrational and conjectured that it is not the root of any algebraic equation of finite degree with rational coefficients. The textbook was somewhat dogmatic in its presentation of ordinary Euclidean thought and includes none of the non-Euclidean ideas beginning to be formed around that time. It was Legendre who first gave a rigorous proof of the theorem (assuming all of Euclid’s postulates, of course) that the sum of the angles of a triangle is “equal to two right angles”. Very little of his research in this area was of memorable quality. The same could possibly be argued for the balance of his writing, but one must acknowledge the very fruitful ideas he left behind in number theory and elliptic functions and, of course, the introduction of Legendre polynomials and the important *Legendre transformation* used both in thermodynamics and Hamiltonian mechanics.

To find $k_n^{(n-1)}$, we look at the evenness or oddness of the polynomials. By an investigation of the Rodriguez formula—as in our study of Hermite polynomials—we note that $P_n(-x) = (-1)^n P_n(x)$, which tells us that $P_n(x)$ is either even or odd. In either case, x will not have an $(n - 1)$ st power. Therefore, $k_n^{(n-1)} = 0$.

We now calculate h_n as given by (8.12):

$$h_n = \frac{(-1)^n k_n^{(n)} n!}{K_n} \int_{-1}^1 (1-x^2)^n dx = \frac{2^n \Gamma(n + \frac{1}{2}) / \Gamma(\frac{1}{2})}{2^n n!} \int_{-1}^1 (1-x^2)^n dx.$$



Adrien-Marie Legendre
1752–1833

The integral can be evaluated by repeated integration by parts (see Problem 8.16). Substituting the result in the expression above yields $h_n = 2/(2n + 1)$.

We need α_n , β_n and γ_n for the recurrence relation:

$$\alpha_n = \frac{k_{n+1}^{(n+1)}}{k_n^{(n)}} = \frac{2^{n+1}\Gamma(n+1+\frac{1}{2})}{(n+1)!\Gamma(\frac{1}{2})} \frac{n!\Gamma(\frac{1}{2})}{2^n\Gamma(n+\frac{1}{2})} = \frac{2n+1}{n+1},$$

where we used the relation $\Gamma(z+1) = z\Gamma(z)$, an important property of the gamma function. We also have $\beta_n = 0$ (because $k_n^{(n-1)} = 0 = k_{n+1}^{(n)}$) and $\gamma_n = -n/(n+1)$. Therefore, the recurrence relation is

$$(n+1)P_{n+1}(x) = (2n+1)xP_n(x) - nP_{n-1}(x). \quad (8.20)$$

Now we use $K_1 = -2$, $P_1(x) = x \Rightarrow k_1^{(1)} = 1$, and $\sigma_2 = -1$ to obtain $\lambda_n = -n(n+1)$, which yields the following differential equation:

$$\frac{d}{dx} \left[(1-x^2) \frac{dP_n}{dx} \right] = -n(n+1)P_n. \quad (8.21)$$

This can also be expressed as

$$(1-x^2) \frac{d^2P_n}{dx^2} - 2x \frac{dP_n}{dx} + n(n+1)P_n = 0. \quad (8.22)$$

8.4.4 Other Classical Orthogonal Polynomials

The rest of the classical orthogonal polynomials can be constructed similarly. For the sake of completeness, we merely quote the results.

Jacobi Polynomials, $P_n^{\mu,\nu}(x)$

Standardization:

$$K_n = (-2)^n n!$$

Constants:

$$k_n^{(n)} = 2^{-n} \frac{\Gamma(2n+\mu+\nu+1)}{n!\Gamma(n+\mu+\nu+1)}, \quad k_n^{(n-1)} = \frac{n(\nu-\mu)}{2n+\mu+\nu} k_n,$$

$$h_n = \frac{2^{\mu+\nu+1}\Gamma(n+\mu+1)\Gamma(n+\nu+1)}{n!(2n+\mu+\nu+1)\Gamma(n+\mu+\nu+1)}$$

Rodriguez formula:

$$P_n^{\mu,\nu}(x) = \frac{(-1)^n}{2^n n!} (1+x)^{-\mu} (1-x)^{-\nu} \frac{d^n}{dx^n} [(1+x)^{\mu+n} (1-x)^{\nu+n}]$$

Differential Equation:

$$(1-x^2) \frac{d^2 P_n^{\mu,\nu}}{dx^2} + [\mu - \nu - (\mu + \nu + 2)x] \frac{d P_n^{\mu,\nu}}{dx} + n(n + \mu + \nu + 1) P_n^{\mu,\nu} = 0$$

A Recurrence Relation:

$$\begin{aligned}
& 2(n+1)(n+\mu+\nu+1)(2n+\mu+\nu)P_{n+1}^{\mu,\nu} \\
&= (2n+\mu+\nu+1)[(2n+\mu+\nu)(2n+\mu+\nu+2)x+\nu^2-\mu^2]P_n^{\mu,\nu} \\
&\quad - 2(n+\mu)(n+\nu)(2n+\mu+\nu+2)P_{n-1}^{\mu,\nu}
\end{aligned}$$

Gegenbauer Polynomials, $C_n^\lambda(x)$ **Standardization:**

$$K_n = (-2)^n n! \frac{\Gamma(n+\lambda+\frac{1}{2})\Gamma(2\lambda)}{\Gamma(n+2\lambda)\Gamma(\lambda+\frac{1}{2})}$$

Constants:

$$k_n^{(n)} = \frac{2^n \Gamma(n+\lambda)}{n! \Gamma(\lambda)}, \quad k_n^{(n-1)} = 0, \quad h_n = \frac{\sqrt{\pi} \Gamma(n+2\lambda)\Gamma(\lambda+\frac{1}{2})}{n!(n+\lambda)\Gamma(2\lambda)\Gamma(\lambda)}$$

Rodriguez Formula:

$$C_n^\lambda(x) = \frac{(-1)^n \Gamma(n+2\lambda)\Gamma(\lambda+\frac{1}{2})}{2^n n! \Gamma(n+\lambda+\frac{1}{2})\Gamma(2\lambda)} (1-x^2)^{-\lambda+1/2} \frac{d^n}{dx^n} [(1-x^2)^{n+\lambda-1/2}]$$

Differential Equation:

$$(1-x^2) \frac{d^2 C_n^\lambda}{dx^2} - (2\lambda+1)x \frac{dC_n^\lambda}{dx} + n(n+2\lambda)C_n^\lambda = 0$$

A Recurrence Relation:

$$(n+1)C_{n+1}^\lambda = 2(n+\lambda)x C_n^\lambda - (n+2\lambda-1)C_{n-1}^\lambda$$

Chebyshev Polynomials of the First Kind, $T_n(x)$ **Standardization:**

$$K_n = (-1)^n \frac{(2n)!}{2^n n!}$$

Constants:

$$k_n^{(n)} = 2^{n-1}, \quad k_n^{(n-1)} = 0, \quad h_n = \frac{\pi}{2}$$

Rodriguez Formula:

$$T_n(x) = \frac{(-1)^n 2^n n!}{(2n)!} (1-x^2)^{1/2} \frac{d^n}{dx^n} [(1-x^2)^{n-1/2}]$$

Differential Equation:

$$(1-x^2) \frac{d^2 T_n}{dx^2} - x \frac{dT_n}{dx} + n^2 T_n = 0$$

A Recurrence Relation:

$$T_{n+1} = 2x T_n - T_{n-1}$$

Chebyshev Polynomials of the Second Kind, $U_n(x)$

Standardization:

$$K_n = (-1)^n \frac{(2n+1)!}{2^n(n+1)!}$$

Constants:

$$k_n^{(n)} = 2^n, \quad k_n^{(n-1)} = 0, \quad h_n = \frac{\pi}{2}$$

Rodriguez Formula:

$$U_n(x) = \frac{(-1)^n 2^n (n+1)!}{(2n+1)!} (1-x^2)^{-1/2} \frac{d^n}{dx^n} [(1-x^2)^{n+1/2}]$$

Differential Equation:

$$(1-x^2) \frac{d^2 U_n}{dx^2} - 3x \frac{dU_n}{dx} + n(n+2)U_n = 0$$

A Recurrence Relation:

$$U_{n+1} = 2xU_n - U_{n-1}$$

8.5 Expansion in Terms of Orthogonal Polynomials

Having studied the different classical orthogonal polynomials, we can now use them to write an arbitrary function $f \in \mathcal{L}_w^2(a, b)$ as a series of these polynomials. If we denote a complete set of orthogonal (not necessarily classical) polynomials by $|C_k\rangle$ and the given function by $|f\rangle$, we may write

$$|f\rangle = \sum_{k=0}^{\infty} a_k |C_k\rangle, \quad (8.23)$$

where a_k is found by multiplying both sides of the equation by $\langle C_i|$ and using the orthogonality of the $|C_k\rangle$'s:

$$\langle C_i|f\rangle = \sum_{k=0}^{\infty} a_k \langle C_i|C_k\rangle = a_i \langle C_i|C_i\rangle \Rightarrow a_i = \frac{\langle C_i|f\rangle}{\langle C_i|C_i\rangle}. \quad (8.24)$$

This is written in function form as

$$a_i = \frac{\int_a^b C_i^*(x) f(x) w(x) dx}{\int_a^b |C_i(x)|^2 w(x) dx}. \quad (8.25)$$

We can also “derive” the functional form of Eq. (8.23) by multiplying both of its sides by $\langle x|$ and using the fact that $\langle x|f\rangle = f(x)$ and $\langle x|C_k\rangle = C_k(x)$. The result will be

$$f(x) = \sum_{k=0}^{\infty} a_k C_k(x). \quad (8.26)$$

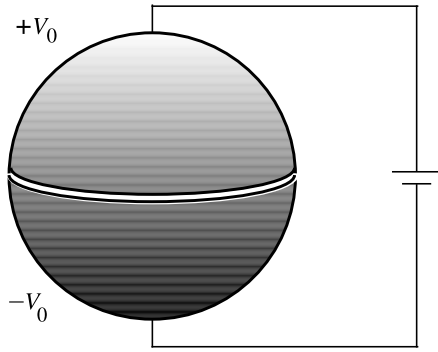

Fig. 8.1 The voltage is $+V_0$ for the upper hemisphere, where $0 \leq \theta < \pi/2$, or where $0 < \cos \theta \leq 1$. It is $-V_0$ for the lower hemisphere, where $\pi/2 < \theta \leq \pi$, or where $-1 \leq \cos \theta < 0$

Example 8.5.1 The solution of Laplace's equation in spherically symmetric electrostatic problems that are independent of the azimuthal angle is given by

$$\Phi(r, \theta) = \sum_{k=0}^{\infty} \left(\frac{b_k}{r^{k+1}} + c_k r^k \right) P_k(\cos \theta). \quad (8.27)$$

Consider two conducting hemispheres of radius a separated by a small insulating gap at the equator. The upper hemisphere is held at potential V_0 and the lower one at $-V_0$, as shown in Fig. 8.1. We want to find the potential at points outside the resulting sphere. Since the potential must vanish at infinity, we expect the second term in Eq. (8.27) to be absent, i.e., $c_k = 0 \forall k$. To find b_k , substitute a for r in (8.27) and let $\cos \theta \equiv x$. Then,

$$\Phi(a, x) = \sum_{k=0}^{\infty} \frac{b_k}{a^{k+1}} P_k(x),$$

where

$$\Phi(a, x) = \begin{cases} -V_0 & \text{if } -1 < x < 0, \\ +V_0 & \text{if } 0 < x < 1. \end{cases}$$

From Eq. (8.25), we have

$$\begin{aligned} \frac{b_k}{a^{k+1}} &= \frac{\int_{-1}^1 P_k(x) \Phi(a, x) dx}{\underbrace{\int_{-1}^1 |P_k(x)|^2 dx}_{=h_k}} = \frac{2k+1}{2} \int_{-1}^1 P_k(x) \Phi(a, x) dx \\ &= \frac{2k+1}{2} V_0 \left[-\int_{-1}^0 P_k(x) dx + \int_0^1 P_k(x) dx \right]. \end{aligned}$$

To proceed, we rewrite the first integral:

$$\int_{-1}^0 P_k(x) dx = -\int_{+1}^0 P_k(-y) dy = \int_0^1 P_k(-y) dy = (-1)^k \int_0^1 P_k(x) dx,$$

where we made use of the parity property of $P_k(x)$. Therefore,

$$\frac{b_k}{a^{k+1}} = \frac{2k+1}{2} V_0 [1 - (-1)^k] \int_0^1 P_k(x) dx.$$

It is now clear that only odd polynomials contribute to the expansion. Using the result of Problem 8.27, we get

$$\frac{b_k}{a^{k+1}} = (-1)^{(k-1)/2} \frac{(2k+1)(k-1)!}{2^k (\frac{k+1}{2})! (\frac{k-1}{2})!} V_0, \quad k \text{ odd},$$

or

$$b_{2m+1} = (4m+3)a^{2m+2} V_0 (-1)^m \frac{(2m)!}{2^{2m+1} m!(m+1)!}.$$

Note that $\Phi(a, x)$ is an odd function; that is, $\Phi(a, -x) = -\Phi(a, x)$ as is evident from its definition. Thus, only odd polynomials appear in the expansion of $\Phi(a, x)$ to preserve this property. Having found the coefficients, we can write the potential:

$$\Phi(r, \theta) = V_0 \sum_{m=0}^{\infty} (-1)^m \frac{(4m+3)(2m)!}{2^{2m+1} m!(m+1)!} \left(\frac{a}{r}\right)^{2m+2} P_{2m+1}(\cos \theta).$$

The place where Legendre polynomials appear most naturally is, as mentioned above, in the solution of Laplace's equation in spherical coordinates. After the partial differential equation is transformed into three ordinary differential equations using the method of the separation of variables, the differential equation corresponding to the polar angle θ gives rise to solutions of which Legendre polynomials are special cases. This differential equation simplifies to Legendre differential equation if the substitution $x = \cos \theta$ is made; in that case, the solutions will be Legendre polynomials in x , or in $\cos \theta$. That is why the argument of $P_k(x)$ is restricted to the interval $[-1, +1]$.

Example 8.5.2 We can expand the Dirac delta function in terms of Legendre polynomial. We write

expanding Dirac delta function in terms of Legendre polynomials

$$\delta(x) = \sum_{n=0}^{\infty} a_n P_n(x), \tag{8.28}$$

where

$$a_n = \frac{2n+1}{2} \int_{-1}^1 P_n(x) \delta(x) dx = \frac{2n+1}{2} P_n(0). \tag{8.29}$$

For odd n this will give zero, because $P_n(x)$ is an odd polynomial. This is to be expected because $\delta(x)$ is an even function of x [$\delta(x) = \delta(-x) = 0$ for $x \neq 0$]. To evaluate $P_n(0)$ for even n , we use the recurrence relation (8.20) for $x = 0$:

$$(n+1)P_{n+1}(0) = -nP_{n-1}(0),$$

or $nP_n(0) = -(n-1)P_{n-2}(0)$, or $P_n(0) = -\frac{n-1}{n}P_{n-2}(0)$. Iterating this m times, we obtain

$$P_n(0) = (-1)^m \frac{(n-1)(n-3)\cdots(n-2m+1)}{n(n-2)(n-4)\cdots(n-2m+2)} P_{n-2m}(0).$$

For $n = 2m$, this yields

$$P_{2m}(0) = (-1)^m \frac{(2m-1)(2m-3)\cdots 3 \cdot 1}{2m(2m-2)\cdots 4 \cdot 2} P_0(0).$$

Now we “fill the gaps” in the numerator by multiplying it—and the denominator, of course—by the denominator. This yields

$$\begin{aligned} P_{2m}(0) &= (-1)^m \frac{2m(2m-1)(2m-2)\cdots 3 \cdot 2 \cdot 1}{[2m(2m-2)\cdots 4 \cdot 2]^2} \\ &= (-1)^m \frac{(2m)!}{[2^m m!]^2} = (-1)^m \frac{(2m)!}{2^{2m} (m!)^2}, \end{aligned}$$

because $P_0(x) = 1$. Thus, we can write

$$\delta(x) = \sum_{m=0}^{\infty} \frac{4m+1}{2} (-1)^m \frac{(2m)!}{2^{2m} (m!)^2} P_{2m}(x).$$

We can also derive this expansion as follows. For any complete set of orthonormal vectors $\{|f_k\rangle\}_{k=1}^{\infty}$, we have

$$\begin{aligned} \delta(x-x') &= w(x)\langle x|x'\rangle = w(x)\langle x|\mathbf{1}|x'\rangle \\ &= w(x)\langle x|\left(\sum_k |f_k\rangle\langle f_k|\right)|x'\rangle = w(x) \sum_k f_k^*(x') f_k(x). \end{aligned}$$

Legendre polynomials are not orthonormal; but we can make them so by dividing $P_k(x)$ by $h_k^{1/2} = \sqrt{2/(2k+1)}$. Then, noting that $w(x) = 1$, we obtain

$$\delta(x-x') = \sum_{k=0}^{\infty} \frac{P_k(x')}{\sqrt{2/(2k+1)}} \frac{P_k(x)}{\sqrt{2/(2k+1)}} = \sum_{k=0}^{\infty} \frac{2k+1}{2} P_k(x') P_k(x).$$

For $x' = 0$ we get

$$\delta(x) = \sum_{k=0}^{\infty} \frac{2k+1}{2} P_k(0) P_k(x),$$

which agrees with Eqs. (8.28) and (8.29).

8.6 Generating Functions

It is possible to generate all orthogonal polynomials of a certain kind from a single function of two variables $g(x, t)$ by repeated differentiation of that function. Such a function is called a **generating function**. This generating function

Table 8.2 Generating functions for Hermite, Laguerre, Legendre, and both Chebyshev polynomials

| Polynomial | Generating function | a_n |
|--------------|---|-----------------------------|
| $H_n(x)$ | $\exp(-t^2 + 2xt)$ | $\frac{1}{n!}$ |
| $L_n^\nu(x)$ | $\frac{\exp[-xt/(1-t)]}{(1-t)^{\nu+1}}$ | 1 |
| $P_n(x)$ | $(t^2 - 2xt + 1)^{-1/2}$ | 1 |
| $T_n(x)$ | $(1 - t^2)(t^2 - 2xt + 1)^{-1}$ | 2 if $n \neq 0$, $a_0 = 1$ |
| $U_n(x)$ | $(t^2 - 2xt + 1)^{-1}$ | 1 |

function is assumed to be expandable in the form

$$g(x, t) = \sum_{n=0}^{\infty} a_n t^n F_n(x), \quad (8.30)$$

so that the n th derivative of $g(x, t)$ with respect to t evaluated at $t = 0$ gives $F_n(x)$ to within a multiplicative constant. The constant a_n is introduced for convenience. Clearly, for $g(x, t)$ to be useful, it must be in closed form. The derivation of such a function for general $F_n(x)$ is nontrivial, and we shall not attempt to derive such a general generating function. Instead, we simply quote these functions in Table 8.2, and leave the derivation of the generating functions of Hermite and Legendre polynomials as Problems 8.12 and 8.21. For Laguerre polynomials see [Hass 08, pp. 679–680].

8.7 Problems

8.1 Let $n = 1$ in Eq. (8.1) and solve for $s \frac{dw}{dx}$. Now substitute this in the derivative of $ws^n p_{\leq k}$ and show that the derivative is equal to $ws^{n-1} p_{\leq k+1}$. Repeat this process m times to prove Lemma 8.1.2.

8.2 Find $w(x)$, a , and b for the case of the classical orthogonal polynomials in which $s(x)$ is of second degree.

8.3 Integrate by parts twice and use Lemma 8.1.2 to show that

$$\int_a^b F_m (ws F_n')' dx = 0 \quad \text{for } m < n.$$

8.4 Using Lemma 8.1.2 conclude that

- $(ws F_n')/w$ is a polynomial of degree less than or equal to n .
- Write $(ws F_n')/w$ as a linear combination of $F_i(x)$, and use their orthogonality and Problem 8.3 to show that the linear combination collapses to a single term.
- Multiply both sides of the differential equation so obtained by F_n and integrate. The RHS becomes $h_n \lambda_n$. For the LHS, carry out the differentiation and note that $(ws)'/w = K_1 F_1$.

Now show that $K_1 F_1 F_n' + s F_n''$ is a polynomial of degree n , and that the LHS of the differential equation yields $\{K_1 k_1^{(1)} n + \sigma_2 n(n-1)\} h_n$. Now find λ_n .

8.5 Derive the recurrence relation of Eq. (8.8). Hint: Differentiate Eq. (8.5) and substitute for F_n'' from the differential equation. Now multiply the resulting equation by $\alpha_n x + \beta_n$ and substitute for $(\alpha_n x + \beta_n) F_n'$ from one of the earlier recurrence relations.

8.6 Using only the orthogonality of Hermite polynomials

$$\int_{-\infty}^{\infty} e^{-x^2} H_m(x) H_n(x) dx = \sqrt{\pi} 2^n n! \delta_{mn}$$

generate the first three of them.

8.7 Use the generalized Rodriguez formula for Hermite polynomials and integration by parts to expand x^{2k} and x^{2k+1} in terms of Hermite polynomials.

8.8 Use the recurrence relation for Hermite polynomials to show that

$$\int_{-\infty}^{\infty} x e^{-x^2} H_m(x) H_n(x) dx = \sqrt{\pi} 2^{n-1} n! [\delta_{m,n-1} + 2(n+1)\delta_{m,n+1}].$$

What happens when $m = n$?

8.9 Apply the general formalism of the recurrence relations given in the book to Hermite polynomials to find the following:

$$H_n + H_{n-1}' - 2x H_{n-1} = 0.$$

8.10 Show that

$$\int_{-\infty}^{\infty} x^2 e^{-x^2} H_n^2(x) dx = \sqrt{\pi} 2^n \left(n + \frac{1}{2}\right) n!$$

8.11 Use a recurrence relations for Hermite polynomials to show that

$$H_n(0) = \begin{cases} 0 & \text{if } n \text{ is odd,} \\ (-1)^m \frac{(2m)!}{m!} & \text{if } n = 2m. \end{cases}$$

8.12 Differentiate the expansion of $g(x, t)$ for Hermite polynomials with respect to x (treating t as a constant) and choose a_n such that $n a_n = a_{n-1}$ to obtain a differential equation for g . Solve this differential equation. To determine the “constant” of integration use the result of Problem 8.11 to show that $g(0, t) = e^{-t^2}$.

8.13 Use the expansion of the generating function for Hermite polynomials to obtain

$$\sum_{m,n=0}^{\infty} e^{-x^2} H_m(x) H_n(x) \frac{s^m t^n}{m! n!} = e^{-x^2 + 2x(st) - (s^2 + t^2)}.$$

Then integrate both sides over x and use the orthogonality of the Hermite polynomials to get

$$\sum_{n=0}^{\infty} \frac{(st)^n}{(n!)^2} \int_{-\infty}^{\infty} e^{-x^2} H_n^2(x) dx = \sqrt{\pi} e^{2st}.$$

Deduce from this the normalization constant h_n of $H_n(x)$.

8.14 Using the recurrence relation of Eq. (8.14) repeatedly, show that

$$\int_{-\infty}^{\infty} x^k e^{-x^2} H_m(x) H_{m+n}(x) dx = \begin{cases} 0 & \text{if } n > k, \\ \sqrt{\pi} 2^m (m+k)! & \text{if } n = k. \end{cases}$$

8.15 Show that for Legendre polynomials, $k_n^{(n)} = 2^n \Gamma(n + \frac{1}{2}) / [n! \Gamma(\frac{1}{2})]$. Hint: Multiply and divide the expression given in the book by $n!$; take a factor of 2 out of all terms in the numerator; the even terms yield a factor of $n!$, and the odd terms give a gamma function.

8.16 Using integration by parts several times, show that

$$\int_{-1}^1 (1-x^2)^n dx = \frac{2^m n(n-1) \cdots (n-m+1)}{3 \cdot 5 \cdot 7 \cdots (2m-1)} \int_{-1}^1 x^{2m} (1-x^2)^{n-m} dx.$$

Now show that

$$\int_{-1}^1 (1-x^2)^n dx = \frac{2\Gamma(\frac{1}{2})n!}{(2n+1)\Gamma(n+\frac{1}{2})}.$$

8.17 Given that $P_0(x) = 1$ and $P_1(x) = x$, find $P_2(x)$, $P_3(x)$, and $P_4(x)$ using an appropriate recurrence relation.

8.18 Use the generalized Rodriguez formula to show that $P_0(1) = 1$ and $P_1(1) = 1$. Now use a recurrence relation to show that $P_n(1) = 1$ for all n . To be rigorous, you need to use mathematical induction.

8.19 Apply the general formalism of the recurrence relations given in the book to find the following two relations for Legendre polynomials:

- (a) $nP_n - xP_n' + P_{n-1}' = 0$.
 (b) $(1-x^2)P_n' - nP_{n-1} + nxP_n = 0$.

8.20 Show that

$$\int_{-1}^1 x^n P_n(x) dx = \frac{2^{n+1}(n!)^2}{(2n+1)!}.$$

Hint: Use the definition of h_n and $k_n^{(n)}$ and the fact that P_n is orthogonal to any polynomial of degree lower than n .

8.21 Differentiate the expansion of $g(x, t)$ for Legendre polynomials, and choose $a_n = 1$. For P'_n , you will substitute two different expressions to get two equations. First use Eq. (8.11) with $n + 1$ replaced by n , to obtain

$$(1 - t^2) \frac{dg}{dx} + tg = 2 \sum_{n=2}^{\infty} nt^n P_{n-1} + 2t.$$

As an alternative, use Eq. (8.10) to substitute for P'_n and get

$$(1 - xt) \frac{dg}{dx} = \sum_{n=2}^{\infty} nt^n P_{n-1} + t.$$

Combine the last two equations to get $(t^2 - 2xt + 1)g' = tg$. Solve this differential equation and determine the “constant” of integration by using $P_n(1) = 1$ to show that $g(1, t) = 1/(1 - t)$.

8.22 Use the generating function for Legendre polynomials to show that $P_n(1) = 1$, $P_n(-1) = (-1)^n$, $P_n(0) = 0$ for odd n , and $P'_n(1) = n(n + 1)/2$.

8.23 Both electrostatic and gravitational potential energies depend on the quantity $1/|\mathbf{r} - \mathbf{r}'|$, where \mathbf{r}' is the position vector of a point inside a charge or mass distribution and \mathbf{r} is the position vector of the observation point.

- (a) Let \mathbf{r} lie along the z -axis, and use spherical coordinates and the definition of generating functions to show that

$$\frac{1}{|\mathbf{r} - \mathbf{r}'|} = \frac{1}{r_{>}} \sum_{n=0}^{\infty} \left(\frac{r_{<}}{r_{>}} \right)^n P_n(\cos \theta),$$

where $r_{<}(r_{>})$ is the smaller (larger) of r and r' , and θ is the polar angle.

- (b) The electrostatic or gravitational potential energy $\Phi(\mathbf{r})$ is given by

$$\Phi(\mathbf{r}) = k \iiint \frac{\rho(\mathbf{r}')}{|\mathbf{r} - \mathbf{r}'|} d^3x',$$

where k is a constant and $\rho(\mathbf{r}')$ is the (charge or mass) density function. Use the result of part (a) to show that if the density depends only on r' , and not on any angle (i.e., ρ is spherically symmetric), then $\Phi(\mathbf{r})$ reduces to the potential energy of a point charge at the origin for $r > r'$.

- (c) What is $\Phi(\mathbf{r})$ for a spherically symmetric density which extends from the origin to a , with $a \gg r$ for any r of interest?
- (d) Show that the electric field \mathbf{E} or gravitational field \mathbf{g} (i.e., the negative gradient of Φ) at any radial distance r from the origin is given by $\frac{kQ(r)}{r^2} \hat{\mathbf{e}}_r$, where $Q(r)$ is the charge or mass enclosed in a sphere of radius r .

8.24 Use the generating function for Legendre polynomials and their orthogonality to derive the relation

$$\int_{-1}^1 \frac{dx}{1 - 2xt + t^2} = \sum_{n=0}^{\infty} t^{2n} \int_{-1}^1 P_n^2(x) dx.$$

Integrate the LHS, expand the result in powers of t , and compare these powers on both sides to obtain the normalization constant h_n .

8.25 Evaluate the following integrals using the expansion of the generating function for Legendre polynomials.

$$(a) \int_0^{\pi} \frac{(a \cos \theta + b) \sin \theta d\theta}{\sqrt{a^2 + 2ab \cos \theta + b^2}}.$$

$$(b) \int_0^{\pi} \frac{(a \cos^2 \theta + b \sin^2 \theta) \sin \theta d\theta}{\sqrt{a^2 + 2ab \cos \theta + b^2}}.$$

8.26 Differentiate the expansion of the Legendre polynomial generating function with respect to x and manipulate the resulting expression to obtain

$$(1 - 2xt + t^2) \sum_{n=0}^{\infty} t^n P_n'(x) = t \sum_{n=0}^{\infty} t^n P_n(x).$$

Equate equal powers of t on both sides to derive the recurrence relation

$$P'_{n+1} + P'_{n-1} - 2xP'_n - P_n = 0.$$

8.27 Show that

$$\int_0^1 P_k(x) dx = \begin{cases} \delta_{k0} & \text{if } k \text{ is even,} \\ \frac{(-1)^{(k+1)/2}(k-1)!}{2^k(\frac{k-1}{2})!(\frac{k+1}{2})!} & \text{if } k \text{ is odd.} \end{cases}$$

Hint: For even k , extend the region of integration to $(-1, 1)$ and use the orthogonality property. For odd k , note that

$$\left. \frac{d^{k-1}}{dx^{k-1}} (1 - x^2)^k \right|_0^1$$

gives zero for the upper limit (by Lemma 8.1.3). For the lower limit, expand the expression using the binomial theorem, and carry out the differentiation, keeping in mind that only one term of the expansion contributes.

8.28 Show that $g(x, t) = g(-x, -t)$ for both Hermite and Legendre polynomials. Now expand $g(x, t)$ and $g(-x, -t)$ and compare the coefficients of t^n to obtain the **parity relations** for these polynomials:

$$H_n(-x) = (-1)^n H_n(x) \quad \text{and} \quad P_n(-x) = (-1)^n P_n(x).$$

8.29 Derive the orthogonality of Legendre polynomials directly from the differential equation they satisfy.

8.30 Expand $|x|$ in the interval $(-1, +1)$ in terms of Legendre polynomials. Hint: Use the result of Problem 8.27.

8.31 Apply the general formalism of the recurrence relations given in the book to find the following two relations for Laguerre polynomials:

- (a) $nL_n^\nu - (n + \nu)L_{n-1}^\nu - x \frac{dL_n^\nu}{dx} = 0.$
 (b) $(n + 1)L_{n+1}^\nu - (2n + \nu + 1 - x)L_n^\nu + (n + \nu)L_{n-1}^\nu = 0.$

8.32 From the generating function for Laguerre polynomials given in Table 8.2 deduce that $L_n^\nu(0) = \Gamma(n + \nu + 1)/[n!\Gamma(\nu + 1)].$

8.33 Let $L_n \equiv L_n^0.$ Now differentiate both sides of

$$g(x, t) = \frac{e^{-xt/(1-t)}}{1-t} = \sum_0^\infty t^n L_n(x)$$

with respect to x and compare powers of t to obtain $L_n'(0) = -n$ and $L_n''(0) = \frac{1}{2}n(n-1).$ Hint: Differentiate $1/(1-t) = \sum_{n=0}^\infty t^n$ to get an expression for $(1-t)^{-2}.$

8.34 Expand e^{-kx} as a series of Laguerre polynomials $L_n^\nu(x).$ Find the coefficients by using (a) the orthogonality of $L_n^\nu(x)$ and (b) the generating function.

8.35 Derive the recurrence relations given in the book for Jacobi, Gegenbauer, and Chebyshev polynomials.

8.36 Show that $T_n(-x) = (-1)^n T_n(x)$ and $U_n(-x) = (-1)^n U_n(x).$ Hint: Use $g(x, t) = g(-x, -t).$

8.37 Show that $T_n(1) = 1, U_n(1) = n + 1, T_n(-1) = (-1)^n, U_n(-1) = (-1)^n(n + 1), T_{2m}(0) = (-1)^m = U_{2m}(0),$ and $T_{2m+1}(0) = 0 = U_{2m+1}(0).$

The single most recurring theme of mathematical physics is Fourier analysis. It shows up, for example, in classical mechanics and the analysis of normal modes, in electromagnetic theory and the frequency analysis of waves, in noise considerations and thermal physics, in quantum theory and the transformation between momentum and coordinate representations, and in relativistic quantum field theory and creation and annihilation operation formalism.

9.1 Fourier Series

One way to begin the study of Fourier series and transforms is to invoke a generalization of the Stone-Weierstrass Approximation Theorem (Theorem 7.2.3), which established the completeness of monomials, x^k . The generalization of Theorem 7.2.3 permits us to find another set of orthogonal functions in terms of which we can expand an arbitrary function. This generalization involves polynomials in more than one variable ([Simm 83, pp. 160–161]):

generalized Stone-Weierstrass theorem

Theorem 9.1.1 (Generalized Stone-Weierstrass Theorem) *If the function $f(x_1, x_2, \dots, x_n)$ is continuous in the domain $\{a_i \leq x_i \leq b_i\}_{i=1}^n$, then it can be expanded in terms of the monomials $x_1^{k_1} x_2^{k_2} \dots x_n^{k_n}$, where the k_i are nonnegative integers.*

Now let us consider functions that are periodic and investigate their expansion in terms of elementary periodic functions. We use the generalized Stone-Weierstrass theorem with two variables, x and y . A function $g(x, y)$ can be written as $g(x, y) = \sum_{k,m=0}^{\infty} a_{km} x^k y^m$. In this equation, x and y can be considered as coordinates in the xy -plane, which in turn can be written in terms of polar coordinates r and θ . In that case, we obtain

$$f(r, \theta) \equiv g(r \cos \theta, r \sin \theta) = \sum_{k,m=0}^{\infty} a_{km} r^{k+m} \cos^k \theta \sin^m \theta.$$

In particular, if we let $r = 1$, we obtain a function of θ alone, which upon substitution of complex exponentials for $\sin \theta$ and $\cos \theta$ becomes

$$f(\theta) = \sum_{k,m=0}^{\infty} a_{km} \frac{1}{2^k} (e^{i\theta} + e^{-i\theta})^k \frac{1}{(2i)^m} (e^{i\theta} - e^{-i\theta})^m = \sum_{n=-\infty}^{\infty} b_n e^{in\theta}, \tag{9.1}$$

where b_n is a constant that depends on a_{km} . The RHS of (9.1) is periodic with period 2π ; thus, it is especially suitable for periodic functions $f(\theta)$ that satisfy the periodicity condition $f(\theta - \pi) = f(\theta + \pi)$.

We can also write Eq. (9.1) as

$$\begin{aligned} f(\theta) &= b_0 + \sum_{n=1}^{\infty} (b_n e^{in\theta} + b_{-n} e^{-in\theta}) \\ &= b_0 + \sum_{n=1}^{\infty} \left[\underbrace{(b_n + b_{-n})}_{\equiv A_n} \cos n\theta + i \underbrace{(b_n - b_{-n})}_{\equiv B_n} \sin n\theta \right] \end{aligned}$$

or

$$f(\theta) = b_0 + \sum_{n=1}^{\infty} (A_n \cos n\theta + B_n \sin n\theta). \tag{9.2}$$

If $f(\theta)$ is real, then b_0 , A_n , and B_n are also real. Equation (9.1) or (9.2) is called the **Fourier series expansion** of $f(\theta)$.

Let us now concentrate on the elementary periodic functions $e^{in\theta}$. We define the $\{|e_n\rangle\}_{n=1}^{\infty}$ such that their “ θ th components” are given by

$$\langle \theta | e_n \rangle = \frac{1}{\sqrt{2\pi}} e^{in\theta}, \quad \text{where } \theta \in (-\pi, \pi).$$

These functions—or ket vectors—which belong to $\mathcal{L}^2(-\pi, \pi)$, are orthonormal, as can be easily verified. It can also be shown that they are complete. In fact, for functions that are *continuous* on $(-\pi, \pi)$, this is a result of the generalized Stone-Weierstrass theorem. It turns out, however, that $\{|e_n\rangle\}_{n=1}^{\infty}$ is also a complete orthonormal sequence for *piecewise continuous* functions on $(-\pi, \pi)$.¹ Therefore, any periodic piecewise continuous function of θ can be expressed as a linear combination of these orthonormal vectors. Thus if $|f\rangle \in \mathcal{L}^2(-\pi, \pi)$, then

$$|f\rangle = \sum_{n=-\infty}^{\infty} f_n |e_n\rangle, \quad \text{where } f_n = \langle e_n | f \rangle. \tag{9.3}$$

Fourier series expansion:
angular expression

We can write this as a functional relation if we take the θ th component of both sides: $\langle \theta | f \rangle = \sum_{n=-\infty}^{\infty} f_n \langle \theta | e_n \rangle$, or

$$f(\theta) = \frac{1}{\sqrt{2\pi}} \sum_{n=-\infty}^{\infty} f_n e^{in\theta} \tag{9.4}$$

¹A piecewise continuous function on a finite interval is one that has a finite number of discontinuities in its interval of definition.

with f_n given by

$$\begin{aligned} f_n &= \langle e_n | \mathbf{1} | f \rangle = \langle e_n | \left(\int_{-\pi}^{\pi} |\theta\rangle \langle \theta| d\theta \right) | f \rangle \\ &= \int_{-\pi}^{\pi} \langle e_n | \theta \rangle \langle \theta | f \rangle d\theta = \frac{1}{\sqrt{2\pi}} \int_{-\pi}^{\pi} e^{-in\theta} f(\theta) d\theta. \end{aligned} \quad (9.5)$$

It is important to note that even though $f(\theta)$ may be defined only for $-\pi \leq \theta \leq \pi$, Eq. (9.4) extends the domain of definition of $f(\theta)$ to all the intervals $(2k - 1)\pi \leq \theta \leq (2k + 1)\pi$ for all $k \in \mathbb{Z}$. Thus, if a function is to be represented by Eq. (9.4) without any specification of the interval of definition, it must be periodic in θ . For such functions, the interval of their definition can be translated by a factor of 2π . Thus, $f(\theta)$ with $-\pi \leq \theta \leq \pi$ is equivalent to $f(\theta - 2m\pi)$ with $2m\pi - \pi \leq \theta \leq 2m\pi + \pi$; both will give the same Fourier series expansion. We shall define periodic functions in their **fundamental cell** such as $(-\pi, \pi)$.

fundamental cell of a periodic function

Historical Notes

Joseph Fourier (1768–1830) did very well as a young student of mathematics but had set his heart on becoming an army officer. Denied a commission because he was the son of a tailor, he went to a Benedictine school with the hope that he could continue studying mathematics at its seminary in Paris. The French Revolution changed those plans and set the stage for many of the personal circumstances of Fourier's later years, due in part to his courageous defense of some of its victims, an action that led to his arrest in 1794. He was released later that year, and he enrolled as a student in the *Ecole Normale*, which opened and closed within a year. His performance there, however, was enough to earn him a position as assistant lecturer (under Lagrange and Monge) in the *Ecole Polytechnique*. He was an excellent mathematical physicist, was a friend of Napoleon (so far as such people have friends), and accompanied him in 1798 to Egypt, where Fourier held various diplomatic and administrative posts while also conducting research. Napoleon took note of his accomplishments and, on Fourier's return to France in 1801, appointed him prefect of the district of Isère, in southeastern France, and in this capacity built the first real road from Grenoble to Turin. He also befriended the boy Champollion, who later deciphered the *Rosetta stone* as the first long step toward understanding the hieroglyphic writing of the ancient Egyptians.

Like other scientists of his time, Fourier took up the flow of heat. The flow was of interest as a practical problem in the handling of metals in industry and as a scientific problem in attempts to determine the temperature in the interior of the earth, the variation of that temperature with time, and other such questions. He submitted a basic paper on heat conduction to the Academy of Sciences of Paris in 1807. The paper was judged by Lagrange, Laplace, and Legendre, and was not published, mainly due to the objections of Lagrange, who had earlier rejected the use of trigonometric series. But the Academy did wish to encourage Fourier to develop his ideas, and so made the problem of the propagation of heat the subject of a grand prize to be awarded in 1812. Fourier submitted a revised paper in 1811, which was judged by the men already mentioned and others. It won the prize but was criticized for its lack of rigor and so was not published at that time in the *Mémoires* of the Academy.

Fourier developed a mastery of clear notation, some of which is still in use today. (The modern integral sign and the placement of the limits of integration near its top and bottom were introduced by Fourier.) It was also his habit to maintain close association between mathematical relations and physically measurable quantities, especially in limiting or asymptotic cases, even performing some of the experiments himself. He was one of the first to begin full incorporation of physical constants into his equations, and made considerable strides toward the modern ideas of units and dimensional analysis.

Fourier continued to work on the subject of heat and, in 1822, published one of the classics of mathematics, *Théorie Analytique de la Chaleur*, in which he made extensive use of the series that now bear his name and incorporated the first part of his 1811 paper practically

"The profound study of nature is the most fruitful source of mathematical discoveries."

Joseph Fourier



Joseph Fourier
1768–1830

without change. Two years later he became secretary of the Academy and was able to have his 1811 paper published in its original form in the *Mémoires*.

Fourier series were of profound significance in connection with the evolution of the concept of a function, the rigorous theory of definite integrals, and the development of **Hilbert spaces**. Fourier claimed that “arbitrary” graphs can be represented by trigonometric series and should therefore be treated as legitimate functions, and it came as a shock to many that he turned out to be right. The classical definition of the definite integral due to Riemann was first given in his fundamental paper of 1854 on the subject of Fourier series. Hilbert thought of a function as represented by an infinite sequence, the Fourier coefficients of the function.

Fourier himself is one of the fortunate few: his name has become rooted in all civilized languages as an adjective that is well-known to physical scientists and mathematicians in every part of the world.

Functions are not always defined on $(-\pi, \pi)$. Let us consider a function $F(x)$ that is defined on (a, b) and is periodic with period $L = b - a$. We define a new variable,

$$\theta \equiv \frac{2\pi}{L} \left(x - a - \frac{L}{2} \right) \Rightarrow x = \frac{L}{2\pi} \theta + a + \frac{L}{2},$$

and note that $f(\theta) \equiv F((L/2\pi)\theta + a + L/2)$ has period $(-\pi, \pi)$ because

$$f(\theta \pm \pi) = F\left(\frac{L}{2\pi}(\theta \pm \pi) + a + \frac{L}{2}\right) = F\left(x \pm \frac{L}{2}\right)$$

and $F(x + L/2) = F(x - L/2)$. It follows that we can expand the latter as in Eq. (9.4). Using that equation, but writing θ in terms of x , we obtain

Fourier series expansion:
general expression

$$\begin{aligned} F(x) &= F\left(\frac{L}{2\pi}\theta + a + \frac{L}{2}\right) = \frac{1}{\sqrt{2\pi}} \sum_{n=-\infty}^{\infty} f_n \exp\left[in \frac{2\pi}{L} \left(x - a - \frac{L}{2}\right)\right] \\ &= \frac{1}{\sqrt{L}} \sum_{n=-\infty}^{\infty} F_n e^{2n\pi i x/L}, \end{aligned} \quad (9.6)$$

where we have introduced² $F_n \equiv \sqrt{L/2\pi} f_n e^{-i(2\pi n/L)(a+L/2)}$. Using Eq. (9.5), we can write

$$\begin{aligned} F_n &= \sqrt{\frac{L}{2\pi}} e^{-i(2\pi n/L)(a+L/2)} \frac{1}{\sqrt{2\pi}} \int_{-\pi}^{\pi} e^{-in\theta} f(\theta) d\theta \\ &= \frac{\sqrt{L}}{2\pi} e^{-i(2\pi n/L)(a+L/2)} \int_a^{a+L} e^{-i(2\pi n/L)(x-a-L/2)} F(x) \frac{2\pi}{L} dx \\ &= \frac{1}{\sqrt{L}} \int_a^b e^{-i(2\pi n/L)x} F(x) dx. \end{aligned} \quad (9.7)$$

The functions $\exp(2\pi i n x/L)/\sqrt{L}$ are easily seen to be orthonormal as members of $\mathcal{L}^2(a, b)$. We can introduce $\{e_n\}_{n=1}^{\infty}$ with the “ x th component” given by $\langle x | e_n \rangle = (1/\sqrt{L})e^{2\pi i n x/L}$. Then the reader may check

²The F_n are defined such that what they multiply in the expansion are orthonormal in the interval (a, b) .

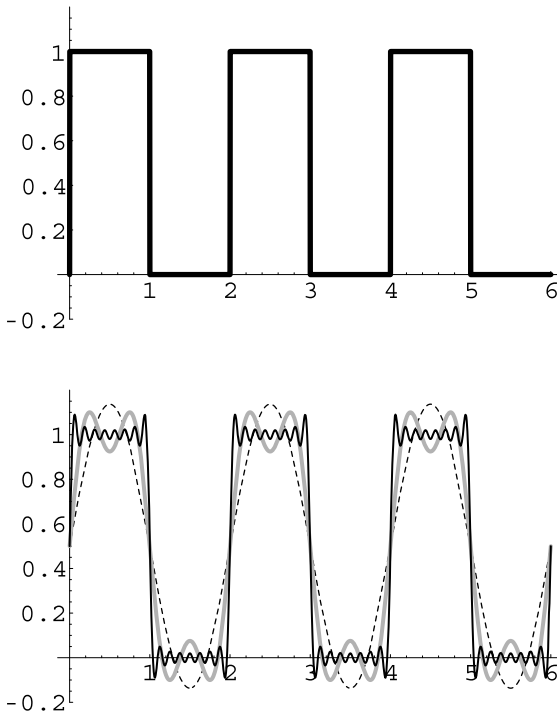

Fig. 9.1 *Top:* The periodic square wave potential with height taken to be 1. *Bottom:* Various approximations to the Fourier series of the square-wave potential. The *dashed plot* is that of the first term of the series, the *thick grey plot* keeps 3 terms, and the *solid plot* 15 terms

that Eqs. (9.6) and (9.7) can be written as $|F\rangle = \sum_{n=-\infty}^{\infty} F_n |e_n\rangle$ with $F_n = \langle n|F\rangle$.

Example 9.1.2 In the study of electrical circuits, periodic voltage signals of different shapes are encountered. An example is a **square wave** voltage of height U_0 , “duration” T , and “rest duration” T [see Fig. 9.1(a)]. The potential as a function of time $V(t)$ can be expanded as a Fourier series. The interval is $(0, 2T)$ because that is one whole cycle of the potential variation. We therefore use Eq. (9.6) and write

square wave voltage

$$V(t) = \frac{1}{\sqrt{2T}} \sum_{n=-\infty}^{\infty} V_n e^{2n\pi i t / 2T}, \quad \text{where}$$

$$V_n = \frac{1}{\sqrt{2T}} \int_0^{2T} e^{-2n\pi i t / 2T} V(t) dt.$$

The problem is to find V_n . This is easily done by substituting

$$V(t) = \begin{cases} U_0 & \text{if } 0 \leq t \leq T, \\ 0 & \text{if } T \leq t \leq 2T \end{cases}$$

in the last integral:

$$\begin{aligned} V_n &= \frac{U_0}{\sqrt{2T}} \int_0^T e^{-in\pi t/T} dt = \frac{U_0}{\sqrt{2T}} \left(-\frac{T}{in\pi} \right) [(-1)^n - 1] \quad \text{where } n \neq 0 \\ &= \begin{cases} 0 & \text{if } n \text{ is even and } n \neq 0, \\ \frac{\sqrt{2T} U_0}{in\pi} & \text{if } n \text{ is odd.} \end{cases} \end{aligned}$$

For $n = 0$, we obtain $V_0 = \frac{1}{\sqrt{2T}} \int_0^{2T} V(t) dt = \frac{1}{\sqrt{2T}} \int_0^T U_0 dt = U_0 \sqrt{\frac{T}{2}}$.
Therefore, we can write

$$\begin{aligned} V(t) &= \frac{1}{\sqrt{2T}} \left[U_0 \sqrt{\frac{T}{2}} + \frac{\sqrt{2T} U_0}{i\pi} \left(\sum_{\substack{n=-\infty \\ n \text{ odd}}}^{-1} \frac{1}{n} e^{in\pi t/T} + \sum_{\substack{n=1 \\ n \text{ odd}}}^{\infty} \frac{1}{n} e^{in\pi t/T} \right) \right] \\ &= U_0 \left\{ \frac{1}{2} + \frac{1}{i\pi} \left[\sum_{\substack{n=1 \\ n \text{ odd}}}^{\infty} \frac{1}{-n} e^{-in\pi t/T} + \sum_{\substack{n=1 \\ n \text{ odd}}}^{\infty} \frac{1}{n} e^{in\pi t/T} \right] \right\} \\ &= U_0 \left\{ \frac{1}{2} + \frac{2}{\pi} \sum_{k=0}^{\infty} \frac{1}{2k+1} \sin\left(\frac{[2k+1]\pi t}{T}\right) \right\}. \end{aligned}$$

Figure 9.1(b) shows the graphical representation of the above infinite sum when only a finite number of terms are present.

sawtooth voltage **Example 9.1.3** Another frequently used voltage is the **sawtooth** voltage [see Fig. 9.2(a)]. The equation for $V(t)$ with period T is $V(t) = U_0 t/T$ for $0 \leq t \leq T$, and its Fourier representation is

$$V(t) = \frac{1}{\sqrt{T}} \sum_{n=-\infty}^{\infty} V_n e^{2n\pi i t/T}, \quad \text{where } V_n = \frac{1}{\sqrt{T}} \int_0^T e^{-2n\pi i t/T} V(t) dt.$$

Substituting for $V(t)$ in the integral above yields

$$\begin{aligned} V_n &= \frac{1}{\sqrt{T}} \int_0^T e^{-2n\pi i t/T} U_0 \frac{t}{T} dt = U_0 T^{-3/2} \int_0^T e^{-2n\pi i t/T} t dt \\ &= U_0 T^{-3/2} \left(\frac{Tt}{-i2n\pi} e^{-2n\pi i t/T} \Big|_0^T + \frac{T}{i2n\pi} \underbrace{\int_0^T e^{-2n\pi i t/T} dt}_{=0} \right) \\ &= U_0 T^{-3/2} \left(\frac{T^2}{-i2n\pi} \right) = -\frac{U_0 \sqrt{T}}{i2n\pi} \quad \text{where } n \neq 0, \\ V_0 &= \frac{1}{\sqrt{T}} \int_0^T V(t) dt = \frac{1}{\sqrt{T}} \int_0^T U_0 \frac{t}{T} dt = \frac{1}{2} U_0 \sqrt{T}. \end{aligned}$$

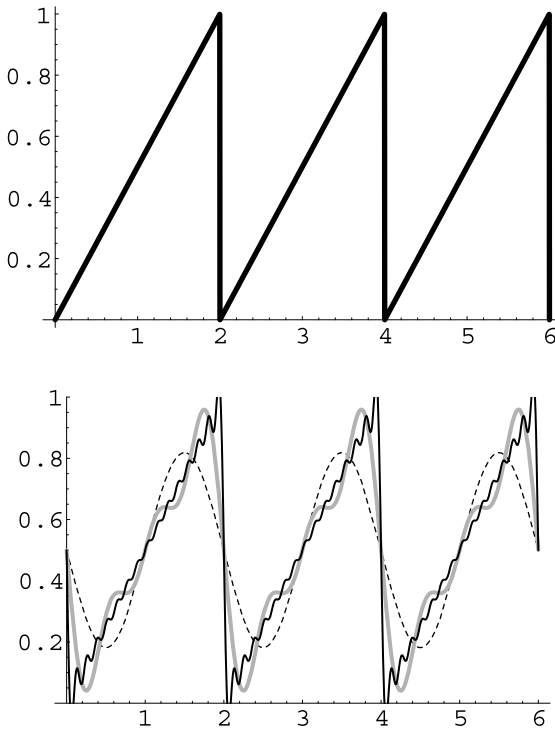

Fig. 9.2 *Top:* The periodic saw-tooth potential with height taken to be 1. *Bottom:* Various approximations to the Fourier series of the sawtooth potential. The *dashed plot* is that of the first term of the series, the *thick grey plot* keeps 3 terms, and the *solid plot* 15 terms

Thus,

$$\begin{aligned}
 V(t) &= \frac{1}{\sqrt{T}} \left[\frac{1}{2} U_0 \sqrt{T} - \frac{U_0 \sqrt{T}}{i2\pi} \left(\sum_{n=-\infty}^{-1} \frac{1}{n} e^{i2n\pi t/T} + \sum_{n=1}^{\infty} \frac{1}{n} e^{i2n\pi t/T} \right) \right] \\
 &= U_0 \left\{ \frac{1}{2} - \frac{1}{\pi} \sum_{n=1}^{\infty} \frac{1}{n} \sin\left(\frac{2n\pi t}{T}\right) \right\}.
 \end{aligned}$$

Figure 9.2(b) shows the graphical representation of the above series keeping the first few terms.

The foregoing examples indicate an important fact about Fourier series. At points of discontinuity (for example, $t = T$ in the preceding two examples), the value of the function is not defined, but the Fourier series expansion assigns it a value—the average of the two values on the right and left of the discontinuity. For instance, when we substitute $t = T$ in the series of Example 9.1.3, all the sine terms vanish and we obtain $V(T) = U_0/2$, the average of U_0 (on the left) and 0 (on the right). We express this as

$$V(T) = \frac{1}{2} [V(T - 0) + V(T + 0)] \equiv \frac{1}{2} \lim_{\epsilon \rightarrow 0} [V(T - \epsilon) + V(T + \epsilon)].$$

This is a general property of Fourier series. In fact, the main theorem of Fourier series, which follows, incorporates this property. (For a proof of this theorem, see [Cour 62].)

Theorem 9.1.4 *The Fourier series of a function $f(\theta)$ that is piecewise continuous in the interval $(-\pi, \pi)$ converges to*

$$\begin{aligned} & \frac{1}{2}[f(\theta + 0) + f(\theta - 0)] \quad \text{for } -\pi < \theta < \pi, \\ & \frac{1}{2}[f(\pi) + f(-\pi)] \quad \text{for } \theta = \pm\pi. \end{aligned}$$

Although we used exponential functions to find the Fourier expansion of the two examples above, it is more convenient to start with the trigonometric series when the expansion of a real function is sought. Equation (9.2) already gives such an expansion. All we need to do now is find expressions for A_n and B_n . From the definitions of A_n and the relation between b_n and f_n we get

$$\begin{aligned} A_n &= b_n + b_{-n} = \frac{1}{\sqrt{2\pi}}(f_n + f_{-n}) \\ &= \frac{1}{\sqrt{2\pi}} \left(\frac{1}{\sqrt{2\pi}} \int_{-\pi}^{\pi} e^{-in\theta} f(\theta) d\theta + \frac{1}{\sqrt{2\pi}} \int_{-\pi}^{\pi} e^{in\theta} f(\theta) d\theta \right) \\ &= \frac{1}{2\pi} \int_{-\pi}^{\pi} [e^{-in\theta} + e^{in\theta}] f(\theta) d\theta = \frac{1}{\pi} \int_{-\pi}^{\pi} \cos n\theta f(\theta) d\theta. \end{aligned} \quad (9.8)$$

Similarly,

$$\begin{aligned} B_n &= \frac{1}{\pi} \int_{-\pi}^{\pi} \sin n\theta f(\theta) d\theta, \\ b_0 &= \frac{1}{\sqrt{2\pi}} f_0 = \frac{1}{2\pi} \int_{-\pi}^{\pi} f(\theta) d\theta \equiv \frac{1}{2} A_0. \end{aligned} \quad (9.9)$$

So, for a function $f(\theta)$ defined in $(-\pi, \pi)$, the Fourier trigonometric series is as in Eq. (9.2) with the coefficients given by Eqs. (9.8) and (9.9). For a function $F(x)$, defined on (a, b) , the trigonometric series becomes

$$F(x) = \frac{1}{2} A_0 + \sum_{n=1}^{\infty} \left(A_n \cos \frac{2n\pi x}{L} + B_n \sin \frac{2n\pi x}{L} \right), \quad (9.10)$$

where

$$\begin{aligned} A_n &= \frac{2}{L} \int_a^b \cos \left(\frac{2n\pi x}{L} \right) F(x) dx, \\ B_n &= \frac{2}{L} \int_a^b \sin \left(\frac{2n\pi x}{L} \right) F(x) dx. \end{aligned} \quad (9.11)$$

A convenient rule to remember is that for even (odd) functions—which are necessarily defined on a symmetric interval around the origin—only cosine (sine) terms appear in the Fourier expansion.

It is useful to have a representation of the Dirac delta function in terms of the present orthonormal basis of Fourier expansion. First we note that we can represent the delta function in terms of a series in *any* set of orthonormal functions (see Problem 9.23):

$$\delta(x - x') = \sum_n f_n(x) f_n^*(x') w(x). \tag{9.12}$$

Next we use the basis of the Fourier expansion for which $w(x) = 1$. We then obtain

$$\delta(x - x') = \sum_{n=-\infty}^{\infty} \frac{e^{2\pi i n x/L}}{\sqrt{L}} \frac{e^{-2\pi i n x'/L}}{\sqrt{L}} = \frac{1}{L} \sum_{n=-\infty}^{\infty} e^{2\pi i n (x-x')/L}.$$

9.1.1 The Gibbs Phenomenon

The plot of the Fourier series expansions in Figs. 9.1(b) and 9.2(b) exhibit a feature that is common to all such expansions: At the discontinuity of the periodic function, the truncated Fourier series overestimates the actual function. This is called the **Gibbs phenomenon**, and is the subject of this subsection.

Gibbs phenomenon

Let us approximate the infinite series with a finite sum. Then

$$\begin{aligned} f_N(\theta) &= \frac{1}{\sqrt{2\pi}} \sum_{n=-N}^N f_n e^{in\theta} = \frac{1}{\sqrt{2\pi}} \sum_{n=-N}^N e^{in\theta} \frac{1}{\sqrt{2\pi}} \int_0^{2\pi} e^{-in\theta'} f(\theta') d\theta' \\ &= \frac{1}{2\pi} \int_0^{2\pi} d\theta' f(\theta') \sum_{n=-N}^N e^{in(\theta-\theta')}, \end{aligned}$$

where we substituted Eq. (9.5) in the sum and, without loss of generality, changed the interval of integration from $(-\pi, \pi)$ to $(0, 2\pi)$. Problem 9.2 shows that

$$\sum_{n=-N}^N e^{in(\theta-\theta')} = \frac{\sin[(N + \frac{1}{2})(\theta - \theta')]}{\sin[\frac{1}{2}(\theta - \theta')]}.$$

It follows that

$$\begin{aligned} f_N(\theta) &= \frac{1}{2\pi} \int_0^{2\pi} d\theta' f(\theta') \frac{\sin[(N + \frac{1}{2})(\theta - \theta')]}{\sin[\frac{1}{2}(\theta - \theta')]} \\ &= \frac{1}{2\pi} \int_{-\theta}^{2\pi-\theta} d\phi f(\phi + \theta) \underbrace{\frac{\sin[(N + \frac{1}{2})\phi]}{\sin(\frac{1}{2}\phi)}}_{\equiv S(\phi)} \\ &\equiv \frac{1}{2\pi} \int_{-\theta}^{2\pi-\theta} d\phi f(\phi + \theta) S(\phi). \end{aligned} \tag{9.13}$$

We want to investigate the behavior of f_N at a discontinuity of f . By translating the limits of integration if necessary, we can assume that the discontinuity of f occurs at a point α such that $0 \neq \alpha \neq 2\pi$. Let us denote the jump at this discontinuity for the function itself by Δf , and for its finite Fourier sum by Δf_N :

$$\Delta f \equiv f(\alpha + \epsilon) - f(\alpha - \epsilon), \quad \Delta f_N \equiv f_N(\alpha + \epsilon) - f_N(\alpha - \epsilon).$$

Then, we have

$$\begin{aligned} \Delta f_N &= \frac{1}{2\pi} \int_{-\alpha-\epsilon}^{2\pi-\alpha-\epsilon} d\phi f(\phi + \alpha + \epsilon) S(\phi) \\ &\quad - \frac{1}{2\pi} \int_{-\alpha+\epsilon}^{2\pi-\alpha+\epsilon} d\phi f(\phi + \alpha - \epsilon) S(\phi) \\ &= \frac{1}{2\pi} \left\{ \int_{-\alpha-\epsilon}^{-\alpha+\epsilon} d\phi f(\phi + \alpha + \epsilon) S(\phi) \right. \\ &\quad \left. + \int_{-\alpha+\epsilon}^{2\pi-\alpha-\epsilon} d\phi f(\phi + \alpha + \epsilon) S(\phi) \right\} \\ &\quad - \frac{1}{2\pi} \left\{ \int_{-\alpha+\epsilon}^{2\pi-\alpha-\epsilon} d\phi f(\phi + \alpha - \epsilon) S(\phi) \right. \\ &\quad \left. + \int_{2\pi-\alpha-\epsilon}^{2\pi-\alpha+\epsilon} d\phi f(\phi + \alpha - \epsilon) S(\phi) \right\} \\ &= \frac{1}{2\pi} \left\{ \int_{-\alpha-\epsilon}^{-\alpha+\epsilon} d\phi f(\phi + \alpha + \epsilon) S(\phi) \right. \\ &\quad \left. - \int_{2\pi-\alpha-\epsilon}^{2\pi-\alpha+\epsilon} d\phi f(\phi + \alpha - \epsilon) S(\phi) \right\} \\ &\quad + \frac{1}{2\pi} \int_{-\alpha+\epsilon}^{2\pi-\alpha-\epsilon} d\phi [f(\phi + \alpha + \epsilon) - f(\phi + \alpha - \epsilon)] S(\phi). \end{aligned}$$

The first two integrals give zero because of the small ranges of integration and the continuity of the integrands in those intervals. The integrand of the third integral is almost zero for all values of the range of integration except when $\phi \approx 0$. Hence, we can confine the integration to the small interval $(-\delta, +\delta)$ for which the difference in the square brackets is simply Δf . It now follows that

$$\Delta f_N(\delta) \approx \frac{\Delta f}{2\pi} \int_{-\delta}^{\delta} \frac{\sin[(N + \frac{1}{2})\phi]}{\sin(\frac{1}{2}\phi)} d\phi \approx \frac{\Delta f}{\pi} \int_0^{\delta} \frac{\sin[(N + \frac{1}{2})\phi]}{\frac{1}{2}\phi} d\phi,$$

where we have emphasized the dependence of f_N on δ and approximated the sine in the denominator by its argument, a good approximation due to the smallness of ϕ . The reader may find the plot of the integrand in Fig. 7.3, where it is shown that the major contribution to the integral comes from the interval $[0, \pi/(N + \frac{1}{2})]$, where $\pi/(N + \frac{1}{2})$ is the first zero of the integrand. Furthermore, it is clear that if the upper limit is larger than $\pi/(N + \frac{1}{2})$, the

result of the integral will decrease, because in each interval of length 2π , the area below the horizontal axis is larger than that above. Therefore, if we are interested in the *maximum* overshoot of the finite sum, we must set the upper limit equal to $\pi/(N + \frac{1}{2})$. It follows firstly that the maximum overshoot of the finite sum occurs at $\pi/(N + \frac{1}{2}) \approx \pi/N$ to the right of the discontinuity. Secondly, the amount of the maximum overshoot is

maximum overshoot in Gibbs phenomenon calculated

$$\begin{aligned}
 (\Delta f_N)_{\max} &\approx \frac{2\Delta f}{\pi} \int_0^{\pi/(N+\frac{1}{2})} \frac{\overbrace{\sin[(N+\frac{1}{2})\phi]}^{\equiv x}}{\phi} d\phi \\
 &= \frac{2}{\pi} \Delta f \int_0^\pi \frac{\sin x}{x} dx \approx 1.179\Delta f.
 \end{aligned}
 \tag{9.14}$$

Thus

Box 9.1.5 (The Gibbs Phenomenon) *The finite (large- N) sum approximation of the discontinuous function overshoots the function itself at a discontinuity by about 18 percent.*

9.1.2 Fourier Series in Higher Dimensions

It is instructive to generalize the Fourier series to more than one dimension. This generalization is especially useful in crystallography and solid-state physics, which deal with three-dimensional periodic structures. To generalize to N dimensions, we first consider a special case in which an N -dimensional periodic function is a product of N one-dimensional periodic functions. That is, we take the N functions

$$f^{(j)}(x) = \frac{1}{\sqrt{L_j}} \sum_{k=-\infty}^{\infty} f_k^{(j)} e^{2i\pi kx/L_j}, \quad j = 1, 2, \dots, N,$$

and multiply them on both sides to obtain

$$F(\mathbf{r}) = f^{(1)}(x_1) f^{(2)}(x_2) \dots f^{(N)}(x_N) = \frac{1}{\sqrt{V}} \sum_{\mathbf{k}} F_{\mathbf{k}} e^{i\mathbf{g}_{\mathbf{k}} \cdot \mathbf{r}}, \tag{9.15}$$

where we have used the following new notations:

$$\begin{aligned}
 F(\mathbf{r}) &\equiv f^{(1)}(x_1) f^{(2)}(x_2) \dots f^{(N)}(x_N), & V &= L_1 L_2 \dots L_N, \\
 \mathbf{k} &\equiv (k_1, k_2, \dots, k_N), & F_{\mathbf{k}} &\equiv f_{k_1} \dots f_{k_N}, \\
 \mathbf{g}_{\mathbf{k}} &= 2\pi(k_1/L_1, \dots, k_N/L_N), & \mathbf{r} &= (x_1, x_2, \dots, x_N).
 \end{aligned}$$

We take Eq. (9.15) as the definition of the Fourier series for *any* periodic function of N variables (not just the product of N functions of a single variable). However, application of (9.15) requires some clarification. In one

dimension, the shape of the smallest region of periodicity is unique. It is simply a line segment of length L , for example. In two and more dimensions, however, such regions may have a variety of shapes. For instance, in two dimensions, they can be rectangles, pentagons, hexagons, and so forth. Thus, we let V in Eq. (9.15) stand for a primitive cell of the N -dimensional lattice. This cell is important in solid-state physics, and (in three dimensions)

Wigner-Seitz cell is called the **Wigner-Seitz cell**.

It is customary to absorb the factor $1/\sqrt{V}$ into $F_{\mathbf{k}}$, and write

$$F(\mathbf{r}) = \sum_{\mathbf{k}} F_{\mathbf{k}} e^{i\mathbf{g}_{\mathbf{k}} \cdot \mathbf{r}} \Leftrightarrow F_{\mathbf{k}} = \frac{1}{V} \int_V F(\mathbf{r}) e^{-i\mathbf{g}_{\mathbf{k}} \cdot \mathbf{r}} d^N x, \quad (9.16)$$

where the sum is a multiple sum over (k_1, \dots, k_N) and the integral is a multiple integral over a single Wigner-Seitz cell.

Recall that $F(\mathbf{r})$ is a periodic function of \mathbf{r} . This means that when \mathbf{r} is changed by \mathbf{R} , where \mathbf{R} is a vector describing the boundaries of a cell, then we should get the same function: $F(\mathbf{r} + \mathbf{R}) = F(\mathbf{r})$. When substituted in (9.16), this yields

$$F(\mathbf{r} + \mathbf{R}) = \sum_{\mathbf{k}} F_{\mathbf{k}} e^{i\mathbf{g}_{\mathbf{k}} \cdot (\mathbf{r} + \mathbf{R})} = \sum_{\mathbf{k}} e^{i\mathbf{g}_{\mathbf{k}} \cdot \mathbf{R}} F_{\mathbf{k}} e^{i\mathbf{g}_{\mathbf{k}} \cdot \mathbf{r}},$$

which is equal to $F(\mathbf{r})$ if

$$e^{i\mathbf{g}_{\mathbf{k}} \cdot \mathbf{R}} = 1, \quad (9.17)$$

i.e., if $\mathbf{g}_{\mathbf{k}} \cdot \mathbf{R}$ is an integral multiple of 2π .

In three dimensions $\mathbf{R} = m_1 \mathbf{a}_1 + m_2 \mathbf{a}_2 + m_3 \mathbf{a}_3$, where m_1, m_2 , and m_3 are integers and $\mathbf{a}_1, \mathbf{a}_2$, and \mathbf{a}_3 are *crystal axes*, which are not generally orthogonal. On the other hand, $\mathbf{g}_{\mathbf{k}} = n_1 \mathbf{b}_1 + n_2 \mathbf{b}_2 + n_3 \mathbf{b}_3$, where n_1, n_2 , and n_3 are integers, and $\mathbf{b}_1, \mathbf{b}_2$, and \mathbf{b}_3 are the **reciprocal lattice vectors** defined by

$$\mathbf{b}_1 = \frac{2\pi(\mathbf{a}_2 \times \mathbf{a}_3)}{\mathbf{a}_1 \cdot (\mathbf{a}_2 \times \mathbf{a}_3)}, \quad \mathbf{b}_2 = \frac{2\pi(\mathbf{a}_3 \times \mathbf{a}_1)}{\mathbf{a}_1 \cdot (\mathbf{a}_2 \times \mathbf{a}_3)}, \quad \mathbf{b}_3 = \frac{2\pi(\mathbf{a}_1 \times \mathbf{a}_2)}{\mathbf{a}_1 \cdot (\mathbf{a}_2 \times \mathbf{a}_3)}.$$

The reader may verify that $\mathbf{b}_i \cdot \mathbf{a}_j = 2\pi \delta_{ij}$. Thus

$$\begin{aligned} \mathbf{g}_{\mathbf{k}} \cdot \mathbf{R} &= \left(\sum_{i=1}^3 n_i \mathbf{b}_i \right) \cdot \left(\sum_{j=1}^3 m_j \mathbf{a}_j \right) = \sum_{i,j} n_i m_j \mathbf{b}_i \cdot \mathbf{a}_j \\ &= 2\pi \sum_{j=1}^3 m_j n_j = 2\pi(\text{integer}), \end{aligned}$$

and Eq. (9.17) is satisfied.

9.2 Fourier Transform

The Fourier series representation of $F(x)$ is valid for the entire real line as long as $F(x)$ is periodic. However, most functions encountered in physical applications are defined in some interval (a, b) without repetition beyond

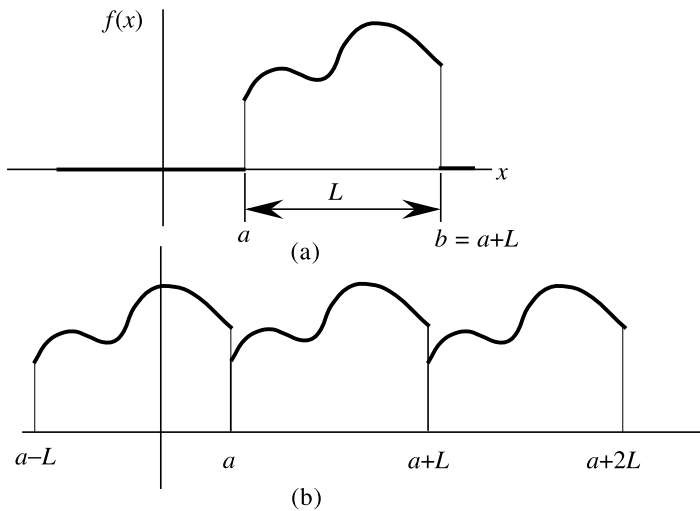

Fig. 9.3 (a) The function we want to represent. (b) The Fourier series representation of the function

that interval. It would be useful if we could also expand such functions in some form of Fourier “series”.

One way to do this is to start with the periodic series and then let the period go to infinity while extending the domain of the definition of the function. As a specific case, suppose we are interested in representing a function $f(x)$ that is defined only for the interval (a, b) and is assigned the value zero everywhere else [see Fig. 9.3(a)]. To begin with, we might try the Fourier series representation, but this will produce a repetition of our function. This situation is depicted in Fig. 9.3(b).

Next we may try a function $g_\Lambda(x)$ defined in the interval $(a - \Lambda/2, b + \Lambda/2)$, where Λ is an arbitrary positive number:

$$g_\Lambda(x) = \begin{cases} 0 & \text{if } a - \Lambda/2 < x < a, \\ f(x) & \text{if } a < x < b, \\ 0 & \text{if } b < x < b + \Lambda/2. \end{cases}$$

This function, which is depicted in Fig. 9.4, has the Fourier series representation

$$g_\Lambda(x) = \frac{1}{\sqrt{L + \Lambda}} \sum_{n=-\infty}^{\infty} g_{\Lambda,n} e^{2i\pi nx/(L+\Lambda)}, \quad (9.18)$$

where

$$g_{\Lambda,n} = \frac{1}{\sqrt{L + \Lambda}} \int_{a-\Lambda/2}^{b+\Lambda/2} e^{-2i\pi nx/(L+\Lambda)} g_\Lambda(x) dx. \quad (9.19)$$

We have managed to separate various copies of the original periodic function by Λ . It should be clear that if $\Lambda \rightarrow \infty$, we can completely isolate the function and stop the repetition. Let us investigate the behavior of Eqs. (9.18) and (9.19) as Λ grows without bound. First, we notice that the

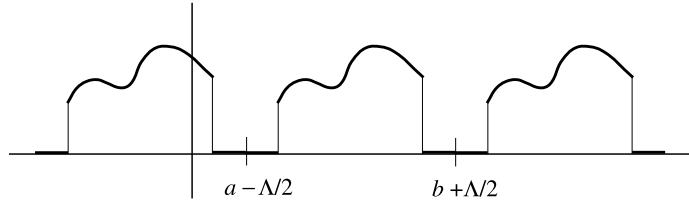

Fig. 9.4 By introducing the parameter Λ , we have managed to separate the copies of the function

quantity k_n defined by $k_n \equiv 2n\pi/(L + \Lambda)$ and appearing in the exponent becomes almost continuous. In other words, as n changes by one unit, k_n changes only slightly. This suggests that the terms in the sum in Eq. (9.18) can be lumped together in j intervals of width Δn_j , giving

$$g_\Lambda(x) \approx \sum_{j=-\infty}^{\infty} \frac{g_\Lambda(k_j)}{\sqrt{L + \Lambda}} e^{ik_j x} \Delta n_j,$$

where $k_j \equiv 2n_j\pi/(L + \Lambda)$, and $g_\Lambda(k_j) \equiv g_{\Lambda,n_j}$. Substituting $\Delta n_j = [(L + \Lambda)/2\pi]\Delta k_j$ in the above sum, we obtain

$$g_\Lambda(x) \approx \sum_{j=-\infty}^{\infty} \frac{g_\Lambda(k_j)}{\sqrt{L + \Lambda}} e^{ik_j x} \frac{L + \Lambda}{2\pi} \Delta k_j = \frac{1}{\sqrt{2\pi}} \sum_{j=-\infty}^{\infty} \tilde{g}_\Lambda(k_j) e^{ik_j x} \Delta k_j,$$

where we introduced $\tilde{g}_\Lambda(k_j)$ defined by $\tilde{g}_\Lambda(k_j) \equiv \sqrt{(L + \Lambda)/2\pi} g_\Lambda(k_j)$. It is now clear that the preceding sum approaches an integral in the limit that $\Lambda \rightarrow \infty$. In the same limit, $g_\Lambda(x) \rightarrow f(x)$, and we have

$$f(x) = \frac{1}{\sqrt{2\pi}} \int_{-\infty}^{\infty} \tilde{f}(k) e^{ikx} dk, \quad (9.20)$$

where

$$\begin{aligned} \tilde{f}(k) &\equiv \lim_{\Lambda \rightarrow \infty} \tilde{g}_\Lambda(k_j) = \lim_{\Lambda \rightarrow \infty} \sqrt{\frac{L + \Lambda}{2\pi}} g_\Lambda(k_j) \\ &= \lim_{\Lambda \rightarrow \infty} \sqrt{\frac{L + \Lambda}{2\pi}} \frac{1}{\sqrt{L + \Lambda}} \int_{a-\Lambda/2}^{b+\Lambda/2} e^{-ik_j x} g_\Lambda(x) dx \\ &= \frac{1}{\sqrt{2\pi}} \int_{-\infty}^{\infty} f(x) e^{-ikx} dx. \end{aligned} \quad (9.21)$$

Fourier integral transforms Equations (9.20) and (9.21) are called the **Fourier integral transforms** of $\tilde{f}(k)$ and $f(x)$, respectively.

Example 9.2.1 Let us evaluate the Fourier transform of the function defined by

$$f(x) = \begin{cases} b & \text{if } |x| < a, \\ 0 & \text{if } |x| > a \end{cases}$$

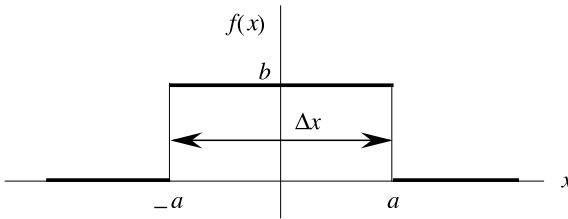

Fig. 9.5 The square “bump” function

(see Fig. 9.5). From (9.21) we have

$$\tilde{f}(k) = \frac{1}{\sqrt{2\pi}} \int_{-\infty}^{\infty} f(x)e^{-ikx} dx = \frac{b}{\sqrt{2\pi}} \int_{-a}^a e^{-ikx} dx = \frac{2ab}{\sqrt{2\pi}} \left(\frac{\sin ka}{ka} \right),$$

which is the function encountered (and depicted) in Example 7.3.2.

Let us discuss this result in detail. First, note that if $a \rightarrow \infty$, the function $f(x)$ becomes a constant function over the entire real line, and we get

$$\tilde{f}(k) = \frac{2b}{\sqrt{2\pi}} \lim_{a \rightarrow \infty} \frac{\sin ka}{k} = \frac{2b}{\sqrt{2\pi}} \pi \delta(k)$$

by the result of Example 7.3.2. This is the Fourier transform of an everywhere-constant function (see Problem 9.12). Next, let $b \rightarrow \infty$ and $a \rightarrow 0$ in such a way that $2ab$, which is the area under $f(x)$, is 1. Then $f(x)$ will approach the delta function, and $\tilde{f}(k)$ becomes

$$\tilde{f}(k) = \lim_{\substack{b \rightarrow \infty \\ a \rightarrow 0}} \frac{2ab}{\sqrt{2\pi}} \frac{\sin ka}{ka} = \frac{1}{\sqrt{2\pi}} \lim_{a \rightarrow 0} \frac{\sin ka}{ka} = \frac{1}{\sqrt{2\pi}}.$$

So the Fourier transform of the delta function is the constant $1/\sqrt{2\pi}$.

Finally, we note that the width of $f(x)$ is $\Delta x = 2a$, and the width of $\tilde{f}(k)$ is roughly the distance, on the k -axis, between its first two roots, k_+ and k_- , on either side of $k = 0$: $\Delta k = k_+ - k_- = 2\pi/a$. Thus increasing the width of $f(x)$ results in a decrease in the width of $\tilde{f}(k)$. In other words, when the function is wide, its Fourier transform is narrow. In the limit of infinite width (a constant function), we get infinite sharpness (the delta function). The last two statements are very general. In fact, it can be shown that $\Delta x \Delta k \geq 1$ for any function $f(x)$. When both sides of this inequality are multiplied by the (reduced) Planck constant $\hbar \equiv h/(2\pi)$, the result is the celebrated **Heisenberg uncertainty relation**.³

Heisenberg uncertainty relation

$$\Delta x \Delta p \geq \hbar,$$

where $p = \hbar k$ is the momentum of the particle.

³In the context of the uncertainty relation, the width of the function—the so-called wave packet—measures the uncertainty in the position x of a quantum mechanical particle. Similarly, the width of the Fourier transform measures the uncertainty in k , which is related to momentum p via $p = \hbar k$.

Having obtained the transform of $f(x)$, we can write

$$f(x) = \frac{1}{\sqrt{2\pi}} \int_{-\infty}^{\infty} \frac{2b}{\sqrt{2\pi}} \frac{\sin ka}{k} e^{ikx} dk = \frac{b}{\pi} \int_{-\infty}^{\infty} \frac{\sin ka}{k} e^{ikx} dk.$$

Example 9.2.2 Let us evaluate the Fourier transform of a Gaussian $g(x) = ae^{-bx^2}$ with $a, b > 0$:

$$\tilde{g}(k) = \frac{a}{\sqrt{2\pi}} \int_{-\infty}^{\infty} e^{-b(x^2+ikx/b)} dx = \frac{ae^{-k^2/4b}}{\sqrt{2\pi}} \int_{-\infty}^{\infty} e^{-b(x+ik/2b)^2} dx.$$

To evaluate this integral rigorously, we would have to use techniques developed in complex analysis, which are not introduced until Chap. 11 (see Example 11.3.8). However, we can ignore the fact that the exponent is complex, substitute $y = x + ik/(2b)$, and write

$$\int_{-\infty}^{\infty} e^{-b[x+ik/(2b)]^2} dx = \int_{-\infty}^{\infty} e^{-by^2} dy = \sqrt{\frac{\pi}{b}}.$$

Thus, we have $\tilde{g}(k) = \frac{a}{\sqrt{2b}} e^{-k^2/(4b)}$, which is also a Gaussian.

We note again that the width of $g(x)$, which is proportional to $1/\sqrt{b}$, is in inverse relation to the width of $\tilde{g}(k)$, which is proportional to \sqrt{b} . We thus have $\Delta x \Delta k \sim 1$.

Equations (9.20) and (9.21) are reciprocals of one another. However, it is not obvious that they are consistent. In other words, if we substitute (9.20) in the RHS of (9.21), do we get an identity? Let's try this:

$$\begin{aligned} \tilde{f}(k) &= \frac{1}{\sqrt{2\pi}} \int_{-\infty}^{\infty} dx e^{-ikx} \left[\frac{1}{\sqrt{2\pi}} \int_{-\infty}^{\infty} \tilde{f}(k') e^{ik'x} dk' \right] \\ &= \frac{1}{2\pi} \int_{-\infty}^{\infty} dx \int_{-\infty}^{\infty} \tilde{f}(k') e^{i(k'-k)x} dk'. \end{aligned}$$

We now change the order of the two integrations:

$$\tilde{f}(k) = \int_{-\infty}^{\infty} dk' \tilde{f}(k') \left[\frac{1}{2\pi} \int_{-\infty}^{\infty} dx e^{i(k'-k)x} \right].$$

But the expression in the square brackets is the delta function (see Example 7.3.2). Thus, we have $\tilde{f}(k) = \int_{-\infty}^{\infty} dk' \tilde{f}(k') \delta(k' - k)$, which is an identity.

As in the case of Fourier series, Eqs. (9.20) and (9.21) are valid even if f and \tilde{f} are piecewise continuous. In that case the Fourier transforms are written as

$$\begin{aligned} \frac{1}{2} [f(x+0) + f(x-0)] &= \frac{1}{\sqrt{2\pi}} \int_{-\infty}^{\infty} \tilde{f}(k) e^{ikx} dk, \\ \frac{1}{2} [\tilde{f}(k+0) + \tilde{f}(k-0)] &= \frac{1}{\sqrt{2\pi}} \int_{-\infty}^{\infty} f(x) e^{-ikx} dx, \end{aligned} \tag{9.22}$$

where each zero on the LHS is an ϵ that has gone to its limit.

It is useful to generalize Fourier transform equations to more than one dimension. The generalization is straightforward:

$$\begin{aligned} f(\mathbf{r}) &= \frac{1}{(2\pi)^{n/2}} \int d^n k e^{i\mathbf{k}\cdot\mathbf{r}} \tilde{f}(\mathbf{k}), \\ \tilde{f}(\mathbf{k}) &= \frac{1}{(2\pi)^{n/2}} \int d^n x f(\mathbf{r}) e^{-i\mathbf{k}\cdot\mathbf{r}}. \end{aligned} \quad (9.23)$$

Let us now use the abstract notation of Sect. 7.3 to get more insight into the preceding results. In the language of Sect. 7.3, Eq. (9.20) can be written as

$$\langle x|f\rangle = \int_{-\infty}^{\infty} \langle k|\tilde{f}\rangle \langle x|k\rangle dk = \langle x|\left(\int_{-\infty}^{\infty} |k\rangle\langle k| dk\right)|\tilde{f}\rangle, \quad (9.24)$$

where we have defined

$$\langle x|k\rangle = \frac{1}{\sqrt{2\pi}} e^{ikx}. \quad (9.25)$$

Equation (9.24) suggests the identification $|\tilde{f}\rangle \equiv |f\rangle$ as well as the identity

$$\mathbf{1} = \int_{-\infty}^{\infty} |k\rangle\langle k| dk, \quad (9.26)$$

which is the same as (7.17). Equation (7.19) yields

$$\langle k|k'\rangle = \delta(k - k'), \quad (9.27)$$

which upon the insertion of a unit operator gives an integral representation of the delta function:

$$\begin{aligned} \delta(k - k') &= \langle k|\mathbf{1}|k'\rangle = \langle k|\left(\int_{-\infty}^{\infty} |x\rangle\langle x| dx\right)|k'\rangle \\ &= \int_{-\infty}^{\infty} \langle k|x\rangle \langle x|k'\rangle dx = \frac{1}{2\pi} \int_{-\infty}^{\infty} dx e^{i(k'-k)x}. \end{aligned}$$

Obviously, we can also write

$$\delta(x - x') = \frac{1}{2\pi} \int_{-\infty}^{\infty} dk e^{i(x-x')k}.$$

If more than one dimension is involved, we use

$$\begin{aligned} \delta(\mathbf{k} - \mathbf{k}') &= \frac{1}{(2\pi)^n} \int d^n x e^{i(\mathbf{k}-\mathbf{k}')\cdot\mathbf{r}}, \\ \delta(\mathbf{r} - \mathbf{r}') &= \frac{1}{(2\pi)^n} \int d^n k e^{i(\mathbf{r}-\mathbf{r}')\cdot\mathbf{k}}, \end{aligned} \quad (9.28)$$

with the inner product relations

$$\langle \mathbf{r}|\mathbf{k}\rangle = \frac{1}{(2\pi)^{n/2}} e^{i\mathbf{k}\cdot\mathbf{r}}, \quad \langle \mathbf{k}|\mathbf{r}\rangle = \frac{1}{(2\pi)^{n/2}} e^{-i\mathbf{k}\cdot\mathbf{r}}. \quad (9.29)$$

Equations (9.28) and (9.29) and the identification $|\tilde{f}\rangle \equiv |f\rangle$ exhibit a striking resemblance between $|\mathbf{r}\rangle$ and $|\mathbf{k}\rangle$. In fact, any given abstract vector $|f\rangle$ can be expressed either in terms of its r representation, $\langle \mathbf{r} | f \rangle = f(\mathbf{r})$, or in terms of its k representation, $\langle \mathbf{k} | f \rangle \equiv \tilde{f}(\mathbf{k})$. These two representations are completely equivalent, and there is a one-to-one correspondence between the two, given by Eq. (9.23). The representation that is used in practice is dictated by the physical application. In quantum mechanics, for instance, most of the time the r representation, corresponding to the position, is used, because then the operator equations turn into differential equations that are (in many cases) linear and easier to solve than the corresponding equations in the k representation, which is related to the momentum.

Fourier transform of the
Coulomb potential

Yukawa potential

Example 9.2.3 In this example we evaluate the Fourier transform of the Coulomb potential $V(r)$ of a point charge q : $V(r) = q/r$. The Fourier transform is important in scattering experiments with atoms, molecules, and solids. As we shall see in the following, the Fourier transform of $V(r)$ is not defined. However, if we work with the **Yukawa potential**,

$$V_\alpha(r) = \frac{qe^{-\alpha r}}{r}, \quad \alpha > 0,$$

the Fourier transform will be well-defined, and we can take the limit $\alpha \rightarrow 0$ to recover the Coulomb potential. Thus, we seek the Fourier transform of $V_\alpha(r)$.

We are working in three dimensions and therefore may write

$$\tilde{V}_\alpha(\mathbf{k}) = \frac{1}{(2\pi)^{3/2}} \iiint d^3x e^{-i\mathbf{k}\cdot\mathbf{r}} \frac{qe^{-\alpha r}}{r}.$$

It is clear from the presence of r that spherical coordinates are appropriate. We are free to pick any direction as the z -axis. A simplifying choice in this case is the direction of \mathbf{k} . So, we let $\mathbf{k} = |\mathbf{k}|\hat{\mathbf{e}}_z = k\hat{\mathbf{e}}_z$, or $\mathbf{k} \cdot \mathbf{r} = kr \cos\theta$, where θ is the polar angle in spherical coordinates. Now we have

$$\tilde{V}_\alpha(\mathbf{k}) = \frac{q}{(2\pi)^{3/2}} \int_0^\infty r^2 dr \int_0^\pi \sin\theta d\theta \int_0^{2\pi} d\varphi e^{-ikr \cos\theta} \frac{e^{-\alpha r}}{r}.$$

The φ integration is trivial and gives 2π . The θ integration is done next:

$$\int_0^\pi \sin\theta e^{-ikr \cos\theta} d\theta = \int_{-1}^1 e^{-ikru} du = \frac{1}{ikr} (e^{ikr} - e^{-ikr}).$$

We thus have

$$\begin{aligned} \tilde{V}_\alpha(\mathbf{k}) &= \frac{q(2\pi)}{(2\pi)^{3/2}} \int_0^\infty dr r^2 \frac{e^{-\alpha r}}{r} \frac{1}{ikr} (e^{ikr} - e^{-ikr}) \\ &= \frac{q}{(2\pi)^{1/2}} \frac{1}{ik} \int_0^\infty dr [e^{(-\alpha+ik)r} - e^{-(\alpha+ik)r}] \\ &= \frac{q}{(2\pi)^{1/2}} \frac{1}{ik} \left(\frac{e^{(-\alpha+ik)r}}{-\alpha+ik} \Big|_0^\infty + \frac{e^{-(\alpha+ik)r}}{\alpha+ik} \Big|_0^\infty \right). \end{aligned}$$

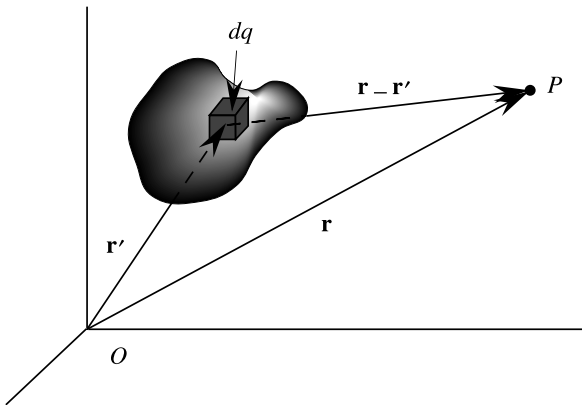

Fig. 9.6 The Fourier transform of the potential of a continuous charge distribution at P is calculated using this geometry

Note how the factor $e^{-\alpha r}$ has tamed the divergent behavior of the exponential at $r \rightarrow \infty$. This was the reason for introducing it in the first place. Simplifying the last expression yields

$$\tilde{V}_\alpha(\mathbf{k}) = \frac{2q}{\sqrt{2\pi}} \frac{1}{k^2 + \alpha^2}.$$

The parameter α is a measure of the range of the potential. It is clear that the larger α is, the smaller the range. In fact, it was in response to the short range of nuclear forces that Yukawa introduced α . For electromagnetism, where the range is infinite, α becomes zero and $V_\alpha(r)$ reduces to $V(r)$. Thus, the Fourier transform of the Coulomb potential is

$$\tilde{V}_{\text{Coul}}(\mathbf{k}) = \frac{2q}{\sqrt{2\pi}} \frac{1}{k^2}.$$

If a charge *distribution* is involved, the Fourier transform will be different.

Example 9.2.4 The example above deals with the electrostatic potential of a point charge. Let us now consider the case where the charge is distributed over a finite volume. Then the potential is

$$V(\mathbf{r}) = \iiint \frac{q\rho(\mathbf{r}')}{|\mathbf{r}' - \mathbf{r}|} d^3x' \equiv q \int \frac{\rho(\mathbf{r}')}{|\mathbf{r}' - \mathbf{r}|} d^3x',$$

where $q\rho(\mathbf{r}')$ is the charge density at \mathbf{r}' , and we have used a single integral because d^3x' already indicates the number of integrations to be performed. Note that we have normalized $\rho(\mathbf{r}')$ so that its integral over the volume is 1, which is equivalent to assuming that the total charge is q . Figure 9.6 shows the geometry of the situation.

Making a change of variables, $\mathbf{R} \equiv \mathbf{r}' - \mathbf{r}$, or $\mathbf{r}' = \mathbf{R} + \mathbf{r}$, and $d^3x' = d^3X$, with $\mathbf{R} \equiv (X, Y, Z)$, we get

$$\tilde{V}(\mathbf{k}) = \frac{1}{(2\pi)^{3/2}} \int d^3x e^{-i\mathbf{k}\cdot\mathbf{r}} q \int \frac{\rho(\mathbf{R} + \mathbf{r})}{R} d^3X. \quad (9.30)$$

To evaluate Eq. (9.30), we substitute for $\rho(\mathbf{R} + \mathbf{r})$ in terms of its Fourier transform,

$$\rho(\mathbf{R} + \mathbf{r}) = \frac{1}{(2\pi)^{3/2}} \int d^3k' \tilde{\rho}(\mathbf{k}') e^{i\mathbf{k}' \cdot (\mathbf{R} + \mathbf{r})}. \quad (9.31)$$

Combining (9.30) and (9.31), we obtain

$$\begin{aligned} \tilde{V}(\mathbf{k}) &= \frac{q}{(2\pi)^3} \int d^3x d^3X d^3k' \frac{e^{i\mathbf{k}' \cdot \mathbf{R}}}{R} \tilde{\rho}(\mathbf{k}') e^{i\mathbf{r} \cdot (\mathbf{k}' - \mathbf{k})} \\ &= q \int d^3X d^3k' \frac{e^{i\mathbf{k}' \cdot \mathbf{R}}}{R} \tilde{\rho}(\mathbf{k}') \underbrace{\left(\frac{1}{(2\pi)^3} \int d^3x e^{i\mathbf{r} \cdot (\mathbf{k}' - \mathbf{k})} \right)}_{\delta(\mathbf{k}' - \mathbf{k})} \\ &= q \tilde{\rho}(\mathbf{k}) \int d^3X \frac{e^{i\mathbf{k} \cdot \mathbf{R}}}{R}. \end{aligned} \quad (9.32)$$

What is nice about this result is that the contribution of the charge distribution, $\tilde{\rho}(\mathbf{k})$, has been completely factored out. The integral, aside from a constant and a change in the sign of \mathbf{k} , is simply the Fourier transform of the Coulomb potential of a point charge obtained in the previous example. We can therefore write Eq. (9.32) as

$$\tilde{V}(\mathbf{k}) = (2\pi)^{3/2} \tilde{\rho}(\mathbf{k}) \tilde{V}_{\text{Coul}}(-\mathbf{k}) = \frac{4\pi q \tilde{\rho}(\mathbf{k})}{|\mathbf{k}|^2}.$$

This equation is important in analyzing the structure of atomic particles. The Fourier transform $\tilde{V}(\mathbf{k})$ is directly measurable in scattering experiments. In a typical experiment a (charged) target is probed with a charged point particle (electron). If the analysis of the scattering data shows a deviation from $1/k^2$ in the behavior of $\tilde{V}(\mathbf{k})$, then it can be concluded that the target particle has a charge distribution. More specifically, a plot of $k^2 \tilde{V}(\mathbf{k})$ versus k gives the variation of $\tilde{\rho}(\mathbf{k})$, the **form factor**, with k . If the resulting graph is a constant, then $\tilde{\rho}(\mathbf{k})$ is a constant, and the target is a point particle [$\tilde{\rho}(\mathbf{k})$ is a constant for point particles, where $\tilde{\rho}(\mathbf{r}') \propto \delta(\mathbf{r} - \mathbf{r}')$]. If there is any deviation from a constant function, $\tilde{\rho}(\mathbf{k})$ must have a dependence on k , and correspondingly, the target particle must have a charge distribution.

The above discussion, when generalized to four-dimensional relativistic space-time, was the basis for a strong argument in favor of the existence of point-like particles—quarks—inside a proton in 1968, when the results of the scattering of high-energy electrons off protons at the Stanford Linear Accelerator Center revealed deviation from a constant for the proton form factor.

9.2.1 Fourier Transforms and Derivatives

The Fourier transform is very useful for solving differential equations. This is because the derivative operator in \mathbf{r} space turns into ordinary multiplication in \mathbf{k} space. For example, if we differentiate $f(\mathbf{r})$ in Eq. (9.23) with

respect to x_j , we obtain

$$\begin{aligned}\frac{\partial}{\partial x_j} f(\mathbf{r}) &= \frac{1}{(2\pi)^{n/2}} \int d^n k \frac{\partial}{\partial x_j} e^{i(k_1 x_1 + \dots + k_j x_j + \dots + k_n x_n)} \tilde{f}(\mathbf{k}) \\ &= \frac{1}{(2\pi)^{n/2}} \int d^n k (i k_j) e^{i\mathbf{k}\cdot\mathbf{r}} \tilde{f}(\mathbf{k}).\end{aligned}$$

That is, every time we differentiate with respect to any component of \mathbf{r} , the corresponding component of \mathbf{k} “comes down”. Thus, the n -dimensional gradient is

$$\nabla f(\mathbf{r}) = \frac{1}{(2\pi)^{n/2}} \int d^n k (i\mathbf{k}) e^{i\mathbf{k}\cdot\mathbf{r}} \tilde{f}(\mathbf{k}),$$

and the n -dimensional Laplacian is

$$\nabla^2 f(\mathbf{r}) = \frac{1}{(2\pi)^{n/2}} \int d^n k (-k^2) e^{i\mathbf{k}\cdot\mathbf{r}} \tilde{f}(\mathbf{k}).$$

We shall use Fourier transforms extensively in solving differential equations later in the book. Here, we can illustrate the above points with a simple example. Consider the ordinary second-order differential equation

$$C_2 \frac{d^2 y}{dx^2} + C_1 \frac{dy}{dx} + C_0 y = f(x),$$

where C_0 , C_1 , and C_2 are constants. We can “solve” this equation by simply substituting the following in it:

$$\begin{aligned}y(x) &= \frac{1}{\sqrt{2\pi}} \int dk \tilde{y}(k) e^{ikx}, & \frac{dy}{dx} &= \frac{1}{\sqrt{2\pi}} \int dk \tilde{y}(k) (ik) e^{ikx}, \\ \frac{d^2 y}{dx^2} &= -\frac{1}{\sqrt{2\pi}} \int dk \tilde{y}(k) k^2 e^{ikx}, & f(x) &= \frac{1}{\sqrt{2\pi}} \int dk \tilde{f}(k) e^{ikx}.\end{aligned}$$

This gives

$$\frac{1}{\sqrt{2\pi}} \int dk \tilde{y}(k) (-C_2 k^2 + i C_1 k + C_0) e^{ikx} = \frac{1}{\sqrt{2\pi}} \int dk \tilde{f}(k) e^{ikx}.$$

Equating the coefficients of e^{ikx} on both sides, we obtain⁴

$$\tilde{y}(k) = \frac{\tilde{f}(k)}{-C_2 k^2 + i C_1 k + C_0}.$$

If we know $\tilde{f}(k)$ [which can be obtained from $f(x)$], we can calculate $y(x)$ by Fourier-transforming $\tilde{y}(k)$. The resulting integrals are not generally easy to evaluate. In some cases the methods of complex analysis may be helpful; in others numerical integration may be the last resort. However, the real power of the Fourier transform lies in the *formal analysis* of differential equations.

⁴Alternatively, we can multiply both sides by $e^{-ik'x}$ and integrate over x . The result of this integration yields $\delta(k - k')$, which collapses the k -integrations and yields the equality of the integrands.

9.2.2 The Discrete Fourier Transform

The preceding remarks alluded to the power of the Fourier transform in solving certain differential equations. If such a solution is combined with numerical techniques, the integrals must be replaced by sums. This is particularly true if our function is given by a table rather than a mathematical relation, a common feature of numerical analysis. So suppose that we are given a set of measurements performed in equal time intervals of Δt . Suppose that the overall period in which these measurements are done is T . We are seeking a Fourier transform of this finite set of data. First we write

$$\tilde{f}(\omega) = \frac{1}{\sqrt{2\pi}} \int_{-\infty}^{\infty} f(t)e^{-i\omega t} dt \approx \frac{1}{\sqrt{2\pi}} \sum_{n=0}^{N-1} f(t_n)e^{-i\omega t_n} \Delta t,$$

or, discretizing the frequency as well and writing $\omega_m = m\Delta\omega$, with $\Delta\omega$ to be determined later, we have

$$\tilde{f}(m\Delta\omega) = \frac{1}{\sqrt{2\pi}} \sum_{n=0}^{N-1} f(n\Delta t)e^{-i(m\Delta\omega)n\Delta t} \left(\frac{T}{N}\right). \quad (9.33)$$

Since the Fourier transform is given in terms of a finite sum, let us explore the idea of writing the inverse transform also as a sum. So, multiply both sides of the above equation by $[e^{i(m\Delta\omega)k\Delta t}/(\sqrt{2\pi})]\Delta\omega$ and sum over m :

$$\begin{aligned} & \frac{1}{\sqrt{2\pi}} \sum_{m=0}^{N-1} \tilde{f}(m\Delta\omega)e^{i(m\Delta\omega)k\Delta t} \Delta\omega \\ &= \frac{T\Delta\omega}{2\pi N} \sum_{n=0}^{N-1} \sum_{m=0}^{N-1} f(n\Delta t)e^{im\Delta\omega\Delta t(k-n)} \\ &= \frac{T\Delta\omega}{2\pi N} \sum_{n=0}^{N-1} f(n\Delta t) \sum_{m=0}^{N-1} e^{im\Delta\omega\Delta t(k-n)}. \end{aligned}$$

Problem 9.2 shows that

$$\sum_{m=0}^{N-1} e^{im\Delta\omega\Delta t(k-n)} = \begin{cases} N & \text{if } k = n, \\ \frac{e^{iN\Delta\omega\Delta t(k-n)} - 1}{e^{i\Delta\omega\Delta t(k-n)} - 1} & \text{if } k \neq n. \end{cases}$$

We want the sum to vanish when $k \neq n$. This suggests demanding that $N\Delta\omega\Delta t(k-n)$ be an integer multiple of 2π . Since $\Delta\omega$ and Δt are to be independent of this (arbitrary) integer (as well as k and n), we must write

$$N\Delta\omega\Delta t(k-n) = 2\pi(k-n) \Rightarrow N\Delta\omega\frac{T}{N} = 2\pi \Rightarrow \Delta\omega = \frac{2\pi}{T}.$$

discrete Fourier
transforms

With this choice, we have the following **discrete Fourier transforms**:

$$\begin{aligned}\tilde{f}(\omega_j) &= \frac{1}{\sqrt{N}} \sum_{n=0}^{N-1} f(t_n) e^{-i\omega_j t_n}, \quad \omega_j = \frac{2\pi j}{T}, \\ f(t_n) &= \frac{1}{\sqrt{N}} \sum_{j=0}^{N-1} \tilde{f}(\omega_j) e^{i\omega_j t_n}, \quad t_n = n\Delta t,\end{aligned}\tag{9.34}$$

where we have redefined the new \tilde{f} to be $\sqrt{2\pi N}/T$ times the old \tilde{f} .

Discrete Fourier transforms are used extensively in numerical calculation of problems in which ordinary Fourier transforms are used. For instance, if a differential equation lends itself to a solution via the Fourier transform as discussed before, then discrete Fourier transforms will give a procedure for finding the solution numerically. Similarly, the frequency analysis of signals is nicely handled by discrete Fourier transforms.

It turns out that discrete Fourier analysis is very intensive computationally. Its status as a popular tool in computational physics is due primarily to a very efficient method of calculation known as the **fast Fourier transform**. In a typical Fourier transform, one has to perform a sum of N terms for every point. Since there are N points to transform, the total computational time will be of order N^2 . In the fast Fourier transform, one takes N to be even and divides the sum into two other sums, one over the even terms and one over the odd terms. Then the computation time will be of order $2 \times (N/2)^2$, or half the original calculation. Similarly, if $N/2$ is even, one can further divide the odd and even sums by two and obtain a computation time of $4 \times (N/4)^2$, or a quarter of the original calculation. In general, if $N = 2^k$, then by dividing the sums consecutively, we end up with N transforms to be performed after k steps. So, the computation time will be $kN = N \log_2 N$. For $N = 128$, the computation time will be $100 \log_2 128 = 700$ as opposed to $128^2 \approx 16,400$, a reduction by a factor of over 20. The fast Fourier transform is indeed fast!

fast Fourier transform

9.2.3 Fourier Transform of a Distribution

Although one can define the Fourier transform of a distribution in exact analogy to an ordinary function, sometimes it is convenient to define the Fourier transform of the distribution as a linear functional.

Let us ignore the distinction between the two variables x and k , and simply define the Fourier transform of a function $f : \mathbb{R} \rightarrow \mathbb{R}$ as

$$\tilde{f}(u) = \frac{1}{\sqrt{2\pi}} \int_{-\infty}^{\infty} f(t) e^{iut} dt.$$

Now we consider two functions, f and g , and note that

$$\langle f, \tilde{g} \rangle \equiv \int_{-\infty}^{\infty} f(u) \tilde{g}(u) du = \int_{-\infty}^{\infty} f(u) \left[\frac{1}{\sqrt{2\pi}} \int_{-\infty}^{\infty} g(t) e^{-iut} dt \right] du$$

$$\begin{aligned}
 &= \int_{-\infty}^{\infty} g(t) \left[\frac{1}{\sqrt{2\pi}} \int_{-\infty}^{\infty} f(u) e^{-iut} du \right] dt \\
 &= \int_{-\infty}^{\infty} g(t) \tilde{f}(t) dt = \langle \tilde{f}, g \rangle.
 \end{aligned}$$

The following definition is motivated by the last equation.

Definition 9.2.5 Let φ be a distribution and let f be a \mathcal{C}_F^∞ function whose Fourier transform \tilde{f} exists and is also a \mathcal{C}_F^∞ function. Then we define the Fourier transform $\tilde{\varphi}$ of φ to be the distribution given by

$$\langle \tilde{\varphi}, f \rangle = \langle \varphi, \tilde{f} \rangle.$$

Example 9.2.6 The Fourier transform of $\delta(x)$ is given by

$$\begin{aligned}
 \langle \tilde{\delta}, f \rangle &= \langle \delta, \tilde{f} \rangle = \tilde{f}(0) = \frac{1}{\sqrt{2\pi}} \int_{-\infty}^{\infty} f(t) dt \\
 &= \int_{-\infty}^{\infty} \left(\frac{1}{\sqrt{2\pi}} \right) f(t) dt = \left\langle \frac{1}{\sqrt{2\pi}}, f \right\rangle.
 \end{aligned}$$

Thus, $\tilde{\delta} = 1/\sqrt{2\pi}$, as expected.

The Fourier transform of $\delta(x - x') \equiv \delta_{x'}(x)$ is given by

$$\begin{aligned}
 \langle \tilde{\delta}_{x'}, f \rangle &= \langle \delta_{x'}, \tilde{f} \rangle = \tilde{f}(x') = \frac{1}{\sqrt{2\pi}} \int_{-\infty}^{\infty} f(t) e^{-ix't} dt \\
 &= \int_{-\infty}^{\infty} \left(\frac{1}{\sqrt{2\pi}} e^{-ix't} \right) f(t) dt.
 \end{aligned}$$

Thus, if $\varphi(x) = \delta(x - x')$, then $\tilde{\varphi}(t) = (1/\sqrt{2\pi})e^{-ix't}$.

9.3 Problems

9.1 Consider the function $f(\theta) = \sum_{m=-\infty}^{\infty} \delta(\theta - 2m\pi)$.

- Show that f is periodic of period 2π .
- What is the Fourier series expansion for $f(\theta)$.

9.2 Break the sum $\sum_{n=-N}^N e^{in(\theta-\theta')}$ into $\sum_{n=-N}^{-1} + \sum_{n=1}^N$. Use the geometric sum formula

$$\sum_{n=0}^N ar^n = a \frac{r^{N+1} - 1}{r - 1}$$

to obtain

$$\sum_{n=1}^N e^{in(\theta-\theta')} = e^{i(\theta-\theta')} \frac{e^{iN(\theta-\theta')} - 1}{e^{i(\theta-\theta')} - 1} = e^{i\frac{1}{2}(N+1)(\theta-\theta')} \frac{\sin[\frac{1}{2}N(\theta-\theta')]}{\sin[\frac{1}{2}(\theta-\theta')]}.$$

By changing n to $-n$ or equivalently, $(\theta - \theta')$ to $-(\theta - \theta')$ find a similar sum from $-N$ to -1 . Now put everything together and use the trigonometric identity

$$2 \cos \alpha \sin \beta = \sin(\alpha + \beta) - \sin(\alpha - \beta)$$

to show that

$$\sum_{n=-N}^N e^{in(\theta-\theta')} = \frac{\sin[(N + \frac{1}{2})(\theta - \theta')]}{\sin[\frac{1}{2}(\theta - \theta')]}.$$

9.3 Find the Fourier series expansion of the periodic function defined on its fundamental cell as

$$f(\theta) = \begin{cases} -\frac{1}{2}(\pi + \theta) & \text{if } -\pi \leq \theta < 0, \\ \frac{1}{2}(\pi - \theta) & \text{if } 0 < \theta \leq \pi. \end{cases}$$

9.4 Show that A_n and B_n in Eq. (9.2) are real when $f(\theta)$ is real.

9.5 Find the Fourier series expansion of the periodic function $f(\theta)$ defined as $f(\theta) = \cos \alpha \theta$ on its fundamental cell, $(-\pi, \pi)$

- (a) when α is an integer;
- (b) when α is not an integer.

9.6 Find the Fourier series expansion of the periodic function defined on its fundamental cell, $(-\pi, \pi)$, as $f(\theta) = \theta$.

9.7 Consider the periodic function that is defined on its fundamental cell, $(-a, a)$, as $f(x) = |x|$.

- (a) Find its Fourier series expansion.
- (b) Show that the infinite series gives the same result as the function when both are evaluated at $x = a$.
- (c) Evaluate both sides of the expansion at $x = 0$, and show that

$$\pi^2 = 8 \sum_{k=0}^{\infty} \frac{1}{(2k+1)^2}.$$

9.8 Let $f(x) = x$ be a periodic function defined over the interval $(0, 2a)$. Find the Fourier series expansion of f .

9.9 Show that the piecewise parabolic “approximation” to $a^2 \sin(\pi x/a)$ in the interval $(-a, a)$ given by the function

$$f(x) = \begin{cases} 4x(a+x) & \text{if } -a \leq x \leq 0 \\ 4x(a-x) & \text{if } 0 \leq x \leq a \end{cases}$$

has the Fourier series expansion

$$f(x) = \frac{32a^2}{\pi^3} \sum_{n=0}^{\infty} \frac{1}{(2n+1)^3} \sin \frac{(2n+1)\pi x}{a}.$$

Plot $f(x)$, $a^2 \sin(\pi x/a)$, and the series expansion (up to 20 terms) for $a = 1$ between -1 and $+1$ on the same graph.

9.10 Find the Fourier series expansion of $f(\theta) = \theta^2$ for $|\theta| < \pi$. Then show that

$$\frac{\pi^2}{6} = \sum_{n=1}^{\infty} \frac{1}{n^2} \quad \text{and} \quad \frac{\pi^2}{12} = -\sum_{n=1}^{\infty} \frac{(-1)^n}{n^2}.$$

9.11 Find the Fourier series expansion of

$$f(t) = \begin{cases} \sin \omega t & \text{if } 0 \leq t \leq \pi/\omega, \\ 0 & \text{if } -\pi/\omega \leq t \leq 0. \end{cases}$$

9.12 What is the Fourier transform of

- (a) the constant function $f(x) = C$, and
- (b) the Dirac delta function $\delta(x)$?

9.13 Show that

- (a) if $g(x)$ is real, then $\tilde{g}^*(k) = \tilde{g}(-k)$, and
- (b) if $g(x)$ is even (odd), then $\tilde{g}(k)$ is also even (odd).

9.14 Let $g_c(x)$ stand for the single function that is nonzero only on a subinterval of the fundamental cell $(a, a + L)$. Define the function $g(x)$ as

$$g(x) = \sum_{j=-\infty}^{\infty} g_c(x - jL).$$

- (a) Show that $g(x)$ is periodic with period L .
- (b) Find its Fourier transform $\tilde{g}(k)$, and verify that

$$\tilde{g}(k) = L\tilde{g}_c(k) \sum_{m=-\infty}^{\infty} \delta(kL - 2m\pi).$$

- (c) Find the (inverse) transform of $\tilde{g}(k)$, and show that it is the Fourier series of $g_c(x)$.

9.15 Evaluate the Fourier transform of

$$g(x) = \begin{cases} b - b|x|/a & \text{if } |x| < a, \\ 0 & \text{if } |x| > a. \end{cases}$$

9.16 Let $f(\theta)$ be a periodic function given by $f(\theta) = \sum_{n=-\infty}^{\infty} a_n e^{in\theta}$. Find its Fourier transform $\tilde{f}(t)$.

9.17 Let

$$f(t) = \begin{cases} \sin \omega_0 t & \text{if } |t| < T, \\ 0 & \text{if } |t| > T. \end{cases}$$

Show that

$$\tilde{f}(\omega) = \frac{1}{\sqrt{2\pi}} \left\{ \frac{\sin[(\omega - \omega_0)T]}{\omega - \omega_0} - \frac{\sin[(\omega + \omega_0)T]}{\omega + \omega_0} \right\}.$$

Verify the uncertainty relation $\Delta\omega\Delta t \approx 4\pi$.

9.18 If $f(x) = g(x + a)$, show that $\tilde{f}(k) = e^{-iak} \tilde{g}(k)$.

9.19 For $a > 0$ find the Fourier transform of $f(x) = e^{-a|x|}$. Is $\tilde{f}(k)$ symmetric? Is it real? Verify the uncertainty relations.

9.20 The displacement of a damped harmonic oscillator is given by

$$f(t) = \begin{cases} Ae^{-\alpha t} e^{i\omega_0 t} & \text{if } t > 0, \\ 0 & \text{if } t < 0. \end{cases}$$

Find $\tilde{f}(\omega)$ and show that the frequency distribution $|\tilde{f}(\omega)|^2$ is given by

$$|\tilde{f}(\omega)|^2 = \frac{A^2}{2\pi} \frac{1}{(\omega - \omega_0)^2 + \alpha^2}.$$

9.21 Prove the **convolution theorem**:

convolution theorem

$$\int_{-\infty}^{\infty} f(x)g(y-x) dx = \int_{-\infty}^{\infty} \tilde{f}(k)\tilde{g}(k)e^{iky} dk.$$

What will this give when $y = 0$?

9.22 Prove **Parseval's relation** for Fourier transforms:

Parseval's relation

$$\int_{-\infty}^{\infty} f(x)g^*(x) dx = \int_{-\infty}^{\infty} \tilde{f}(k)\tilde{g}^*(k) dk.$$

In particular, the norm of a function—with weight function equal to 1—is invariant under Fourier transform.

9.23 Use the completeness relation $\mathbf{1} = \sum_n |n\rangle\langle n|$ and sandwich it between $|x\rangle$ and $\langle x'|$ to find an expression for the Dirac delta function in terms of an infinite series of orthonormal functions.

9.24 Use a Fourier transform in three dimensions to find a solution of the Poisson equation: $\nabla^2\Phi(\mathbf{r}) = -4\pi\rho(\mathbf{r})$.

9.25 For $\varphi(x) = \delta(x - x')$, find $\tilde{\varphi}(y)$.

9.26 Show that $\tilde{\tilde{f}}(t) = f(-t)$.

9.27 The Fourier transform of a distribution φ is given by

$$\tilde{\varphi}(t) = \sum_{n=0}^{\infty} \frac{1}{n!} \delta'(t - n).$$

What is $\varphi(x)$? Hint: Use $\tilde{\tilde{\varphi}}(x) = \varphi(-x)$

9.28 For $f(x) = \sum_{k=0}^n a_k x^k$, show that

$$\tilde{f}(u) = \sqrt{2\pi} \sum_{k=0}^n i^k a_k \delta^{(k)}(u), \quad \text{where} \quad \delta^{(k)}(u) \equiv \frac{d^k}{du^k} \delta(u).$$

Part III
Complex Analysis

Complex analysis, just like real analysis, deals with questions of continuity, convergence of series, differentiation, integration, and so forth. The reader is assumed to have been exposed to the *algebra* of complex numbers.

10.1 Complex Functions

A complex function is a map $f : \mathbb{C} \rightarrow \mathbb{C}$, and we write $f(z) = w$, where both z and w are complex numbers.¹ The map f can be geometrically thought of as a correspondence between two complex planes, the z -plane and the w -plane. The w -plane has a real axis and an imaginary axis, which we can call u and v , respectively. Both u and v are real functions of the coordinates of z , i.e., x and y . Therefore, we may write

$$f(z) = u(x, y) + iv(x, y). \quad (10.1)$$

This equation gives a unique point (u, v) in the w -plane for each point (x, y) in the z -plane (see Fig. 10.1). Under f , regions of the z -plane are mapped onto regions of the w -plane. For instance, a curve in the z -plane may be mapped into a curve in the w -plane. The following example illustrates this point.

Example 10.1.1 Let us investigate the behavior of a couple of elementary complex functions. In particular, we shall look at the way a line $y = mx$ in the z -plane is mapped into curves in the w -plane.

(a) For $w = f(z) = z^2$, we have

$$w = (x + iy)^2 = x^2 - y^2 + 2ixy,$$

¹Strictly speaking, we should write $f : S \rightarrow \mathbb{C}$ where S is a *subset* of the complex plane. The reason is that most functions are not defined for the entire set of complex numbers, so that the domain of such functions is not necessarily \mathbb{C} . We shall specify the domain only when it is absolutely necessary. Otherwise, we use the generic notation $f : \mathbb{C} \rightarrow \mathbb{C}$, even though f is defined only on a subset of \mathbb{C} .

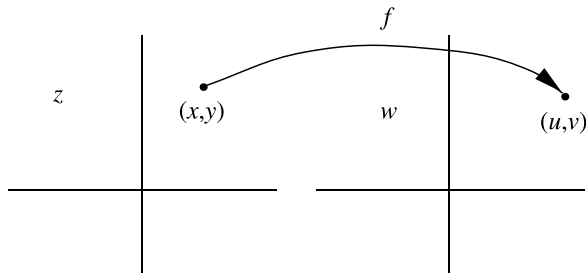

Fig. 10.1 A map from the z -plane to the w -plane

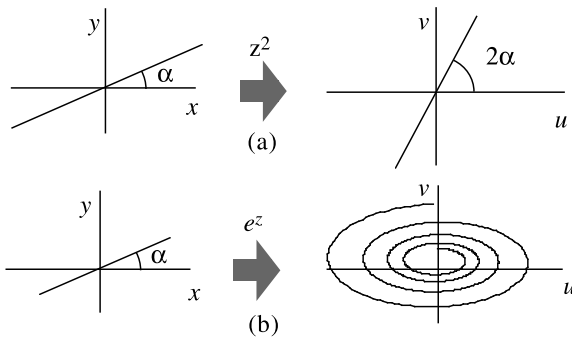

Fig. 10.2 (a) The map z^2 takes a line with slope angle α and maps it to a line with twice the angle in the w -plane. (b) The map e^z takes the same line and maps it to a spiral in the w -plane

with $u(x, y) = x^2 - y^2$ and $v(x, y) = 2xy$. How does the region of \mathbb{C} consisting of all points of a line get mapped into \mathbb{C} ? For $y = mx$, i.e., for a line in the z -plane with slope m , these equations yield $u = (1 - m^2)x^2$ and $v = 2mx^2$. Eliminating x in these equations, we find $v = [2m/(1 - m^2)]u$. This is a line passing through the origin of the w -plane [see Fig. 10.2(a)]. Note that the angle the image line makes with the real axis of the w -plane is twice the angle the original line makes with the x -axis. (Show this!).

- (b) The function $w = f(z) = e^z = e^{x+iy}$ gives $u(x, y) = e^x \cos y$ and $v(x, y) = e^x \sin y$. What is the image of the line $y = mx$ under this map? Substituting $y = mx$, we obtain $u = e^x \cos mx$ and $v = e^x \sin mx$. Unlike part (a), we cannot eliminate x to find v as an explicit function of u . Nevertheless, the last pair of equations are *parametric equations* of a curve, which we can plot in a uv -plane as shown in Fig. 10.2(b).

Limits of complex functions are defined in terms of absolute values. Thus, $\lim_{z \rightarrow a} f(z) = w_0$ means that given any real number $\epsilon > 0$, we can find a corresponding real number $\delta > 0$ such that $|f(z) - w_0| < \epsilon$ whenever $|z - a| < \delta$. Similarly, we say that a function f is **continuous** at $z = a$ if $\lim_{z \rightarrow a} f(z) = f(a)$.

10.2 Analytic Functions

The derivative of a complex function is defined as usual:

Definition 10.2.1 Let $f : \mathbb{C} \rightarrow \mathbb{C}$ be a complex function. The **derivative** of f at z_0 is

$$\left. \frac{df}{dz} \right|_{z_0} = \lim_{\Delta z \rightarrow 0} \frac{f(z_0 + \Delta z) - f(z_0)}{\Delta z},$$

provided that the limit exists and is independent of Δz .

In this definition “independent of Δz ” means independent of Δx and Δy (the components of Δz) and, therefore, independent of the direction of approach to z_0 . The restrictions of this definition apply to the real case as well. For instance, the derivative of $f(x) = |x|$ at $x = 0$ does not exist² because it approaches $+1$ from the right and -1 from the left.

It can easily be shown that all the formal rules of differentiation that apply to the real case also apply to the complex case. For example, if f and g are differentiable, then $f \pm g$, fg , and—as long as g is not zero at the point of interest— f/g are also differentiable, and their derivatives are given by the usual rules of differentiation.

Example 10.2.2 Let us examine the derivative of $f(z) = x^2 + 2iy^2$ at $z = 1 + i$:

$$\begin{aligned} \left. \frac{df}{dz} \right|_{z=1+i} &= \lim_{\Delta z \rightarrow 0} \frac{f(1+i+\Delta z) - f(1+i)}{\Delta z} \\ &= \lim_{\substack{\Delta x \rightarrow 0 \\ \Delta y \rightarrow 0}} \frac{(1+\Delta x)^2 + 2i(1+\Delta y)^2 - 1 - 2i}{\Delta x + i\Delta y} \\ &= \lim_{\substack{\Delta x \rightarrow 0 \\ \Delta y \rightarrow 0}} \frac{2\Delta x + 4i\Delta y + (\Delta x)^2 + 2i(\Delta y)^2}{\Delta x + i\Delta y}. \end{aligned}$$

Example illustrating path dependence of derivative

Let us approach $z = 1 + i$ along the line $y - 1 = m(x - 1)$. Then $\Delta y = m\Delta x$, and the limit yields

$$\left. \frac{df}{dz} \right|_{z=1+i} = \lim_{\Delta x \rightarrow 0} \frac{2\Delta x + 4im\Delta x + (\Delta x)^2 + 2im^2(\Delta x)^2}{\Delta x + im\Delta x} = \frac{2 + 4im}{1 + im}.$$

It follows that we get infinitely many values for the derivative depending on the value we assign to m , i.e., depending on the direction along which we approach $1 + i$. Thus, the derivative does not exist at $z = 1 + i$.

It is clear from the definition that differentiability puts a severe restriction on $f(z)$ because it requires the limit to be the same for *all paths* going through z_0 . Furthermore, differentiability is a *local* property: To test

²One can rephrase this and say that the derivative exists, but not in terms of ordinary functions, rather, in terms of *generalized* functions—in this case $\theta(x)$ —discussed in Sect. 7.3.

whether or not a function $f(z)$ is differentiable at z_0 , we move away from z_0 only by a small amount Δz and check the existence of the limit in Definition 10.2.1.

What are the conditions under which a complex function is differentiable? For $f(z) = u(x, y) + i v(x, y)$, Definition 10.2.1 yields

$$\left. \frac{df}{dz} \right|_{z_0} = \lim_{\substack{\Delta x \rightarrow 0 \\ \Delta y \rightarrow 0}} \left\{ \frac{u(x_0 + \Delta x, y_0 + \Delta y) - u(x_0, y_0)}{\Delta x + i \Delta y} + i \frac{v(x_0 + \Delta x, y_0 + \Delta y) - v(x_0, y_0)}{\Delta x + i \Delta y} \right\}.$$

If this limit is to exist for all paths, it must exist for the two particular paths on which $\Delta y = 0$ (parallel to the x -axis) and $\Delta x = 0$ (parallel to the y -axis). For the first path we get

$$\begin{aligned} \left. \frac{df}{dz} \right|_{z_0} &= \lim_{\Delta x \rightarrow 0} \frac{u(x_0 + \Delta x, y_0) - u(x_0, y_0)}{\Delta x} \\ &\quad + i \lim_{\Delta x \rightarrow 0} \frac{v(x_0 + \Delta x, y_0) - v(x_0, y_0)}{\Delta x} = \left. \frac{\partial u}{\partial x} \right|_{(x_0, y_0)} + i \left. \frac{\partial v}{\partial x} \right|_{(x_0, y_0)}. \end{aligned}$$

For the second path ($\Delta x = 0$), we obtain

$$\begin{aligned} \left. \frac{df}{dz} \right|_{z_0} &= \lim_{\Delta y \rightarrow 0} \frac{u(x_0, y_0 + \Delta y) - u(x_0, y_0)}{i \Delta y} \\ &\quad + i \lim_{\Delta y \rightarrow 0} \frac{v(x_0, y_0 + \Delta y) - v(x_0, y_0)}{i \Delta y} = -i \left. \frac{\partial u}{\partial y} \right|_{(x_0, y_0)} + \left. \frac{\partial v}{\partial y} \right|_{(x_0, y_0)}. \end{aligned}$$

If f is to be differentiable at z_0 , the derivatives along the two paths must be equal. Equating the real and imaginary parts of both sides of this equation and ignoring the subscript z_0 (x_0, y_0 , or z_0 is arbitrary), we obtain

$$\frac{\partial u}{\partial x} = \frac{\partial v}{\partial y} \quad \text{and} \quad \frac{\partial u}{\partial y} = -\frac{\partial v}{\partial x}. \quad (10.2)$$

These two conditions, which are necessary for the differentiability of f , are called the **Cauchy-Riemann conditions**.

An alternative way of writing the Cauchy-Riemann (C-R) conditions is obtained by making the substitution³ $x = \frac{1}{2}(z + z^*)$ and $y = \frac{1}{2i}(z - z^*)$ in $u(x, y)$ and $v(x, y)$, using the chain rule to write Eq. (10.2) in terms of z and z^* , substituting the results in $\frac{\partial f}{\partial z^*} = \frac{\partial u}{\partial z^*} + i \frac{\partial v}{\partial z^*}$ and showing that Eq. (10.2) is equivalent to the single equation $\partial f / \partial z^* = 0$. This equation says that

Box 10.2.3 *If f is to be differentiable, it must be independent of z^* .*

³We use z^* to indicate the complex conjugate of z . Occasionally we may use \bar{z} .

If the derivative of f exists, the arguments leading to Eq. (10.2) imply that the derivative can be expressed as

$$\frac{df}{dz} = \frac{\partial u}{\partial x} + i \frac{\partial v}{\partial x} = \frac{\partial v}{\partial y} - i \frac{\partial u}{\partial y}. \quad (10.3)$$

Expression for the derivative of a differentiable complex function

The C-R conditions assure us that these two equations are equivalent.

The following example illustrates the differentiability of complex functions.

Example 10.2.4 Let us determine whether or not the following functions are differentiable:

- (a) We have already established that $f(z) = x^2 + 2iy^2$ is not differentiable at $z = 1 + i$. We can now show that it has no derivative at any point in the complex plane (except at the origin). This is easily seen by noting that $u = x^2$ and $v = 2y^2$, and that $\partial u/\partial x = 2x \neq \partial v/\partial y = 4y$, and the first Cauchy-Riemann condition is not satisfied. The second C-R condition is satisfied, but that is not enough.

We can also write $f(z)$ in terms of z and z^* :

$$\begin{aligned} f(z) &= \left[\frac{1}{2}(z + z^*) \right]^2 + 2i \left[\frac{1}{2i}(z - z^*) \right]^2 \\ &= \frac{1}{4}(1 - 2i)(z^2 + z^{*2}) + \frac{1}{2}(1 + 2i)zz^*. \end{aligned}$$

$f(z)$ has an explicit dependence on z^* . Therefore, it is not differentiable.

- (b) Now consider $f(z) = x^2 - y^2 + 2ixy$, for which $u = x^2 - y^2$ and $v = 2xy$. The C-R conditions become $\partial u/\partial x = 2x = \partial v/\partial y$ and $\partial u/\partial y = -2y = -\partial v/\partial x$. Thus, $f(z)$ may be differentiable. Recall that the C-R conditions are only *necessary* conditions; we have not shown (but we will, shortly) that they are also sufficient.

To check the dependence of f on z^* , substitute $x = (z + z^*)/2$ and $y = (z - z^*)/(2i)$ in u and v to show that $f(z) = z^2$, and thus there is no z^* dependence.

- (c) Let $u(x, y) = e^x \cos y$ and $v(x, y) = e^x \sin y$. Then $\partial u/\partial x = e^x \cos y = \partial v/\partial y$ and $\partial u/\partial y = -e^x \sin y = -\partial v/\partial x$, and the C-R conditions are satisfied. Also,

$$f(z) = e^x \cos y + ie^x \sin y = e^x (\cos y + i \sin y) = e^x e^{iy} = e^{x+iy} = e^z,$$

and there is no z^* dependence.

The requirement of differentiability is very restrictive: The derivative must exist along infinitely many paths. On the other hand, the C-R conditions seem deceptively mild: They are derived for only two paths. Nevertheless, the two paths are, in fact, true representatives of all paths; that is, the C-R conditions are not only necessary, but also sufficient:

Theorem 10.2.5 *The function $f(z) = u(x, y) + iv(x, y)$ is differentiable in a region of the complex plane if and only if the Cauchy-Riemann conditions,*

$$\frac{\partial u}{\partial x} = \frac{\partial v}{\partial y} \quad \text{and} \quad \frac{\partial u}{\partial y} = -\frac{\partial v}{\partial x}$$

(or, equivalently, $\partial f/\partial z^ = 0$), are satisfied and all first partial derivatives of u and v are continuous in that region. In that case*

$$\frac{df}{dz} = \frac{\partial u}{\partial x} + i \frac{\partial v}{\partial x} = \frac{\partial v}{\partial y} - i \frac{\partial u}{\partial y}.$$

Proof We have already shown the “only if” part. To show the “if” part, note that if the derivative exists at all, it must equal (10.3). Thus, we have to show that

$$\lim_{\Delta z \rightarrow 0} \frac{f(z + \Delta z) - f(z)}{\Delta z} = \frac{\partial u}{\partial x} + i \frac{\partial v}{\partial x}$$

or, equivalently, that

$$\left| \frac{f(z + \Delta z) - f(z)}{\Delta z} - \left(\frac{\partial u}{\partial x} + i \frac{\partial v}{\partial x} \right) \right| < \epsilon \quad \text{whenever } |\Delta z| < \delta.$$

By definition,

$$\begin{aligned} f(z + \Delta z) - f(z) &= u(x + \Delta x, y + \Delta y) + iv(x + \Delta x, y + \Delta y) - u(x, y) - iv(x, y). \end{aligned}$$

Since u and v have continuous first partial derivatives, we can write

$$\begin{aligned} u(x + \Delta x, y + \Delta y) &= u(x, y) + \frac{\partial u}{\partial x} \Delta x + \frac{\partial u}{\partial y} \Delta y + \epsilon_1 \Delta x + \delta_1 \Delta y, \\ v(x + \Delta x, y + \Delta y) &= v(x, y) + \frac{\partial v}{\partial x} \Delta x + \frac{\partial v}{\partial y} \Delta y + \epsilon_2 \Delta x + \delta_2 \Delta y, \end{aligned}$$

where $\epsilon_1, \epsilon_2, \delta_1,$ and δ_2 are real numbers that approach zero as Δx and Δy approach zero. Using these expressions, we can write

$$\begin{aligned} f(z + \Delta z) - f(z) &= \left(\frac{\partial u}{\partial x} + i \frac{\partial v}{\partial x} \right) \Delta x + i \left(-i \frac{\partial u}{\partial y} + \frac{\partial v}{\partial y} \right) \Delta y \\ &\quad + (\epsilon_1 + i\epsilon_2) \Delta x + (\delta_1 + i\delta_2) \Delta y \\ &= \left(\frac{\partial u}{\partial x} + i \frac{\partial v}{\partial x} \right) (\Delta x + i \Delta y) + \epsilon \Delta x + \delta \Delta y, \end{aligned}$$

where $\epsilon \equiv \epsilon_1 + i\epsilon_2, \delta \equiv \delta_1 + i\delta_2,$ and we used the C-R conditions in the last step. Dividing both sides by $\Delta z = \Delta x + i \Delta y,$ we get

$$\frac{f(z + \Delta z) - f(z)}{\Delta z} - \left(\frac{\partial u}{\partial x} + i \frac{\partial v}{\partial x} \right) = \epsilon \frac{\Delta x}{\Delta z} + \delta \frac{\Delta y}{\Delta z}.$$

By the triangle inequality, $|\text{RHS}| \leq |\epsilon_1 + i\epsilon_2| + |\delta_1 + i\delta_2|$. This follows from the fact that $|\Delta x|/|\Delta z|$ and $|\Delta y|/|\Delta z|$ are both equal to at most 1. The ϵ and δ terms can be made as small as desired by making Δz small enough. We have thus established that when the C-R conditions hold, the function f is differentiable. \square

Historical Notes

Augustin-Louis Cauchy (1789–1857) was one of the most influential French mathematicians of the nineteenth century. He began his career as a military engineer, but when his health broke down in 1813 he followed his natural inclination and devoted himself wholly to mathematics.

In mathematical productivity Cauchy was surpassed only by Euler, and his collected works fill 27 fat volumes. He made substantial contributions to number theory and determinants; is considered to be the originator of the theory of finite groups; and did extensive work in astronomy, mechanics, optics, and the theory of elasticity.

His greatest achievements, however, lay in the field of analysis. Together with his contemporaries Gauss and Abel, he was a pioneer in the rigorous treatment of limits, continuous functions, derivatives, integrals, and infinite series. Several of the basic tests for the convergence of series are associated with his name. He also provided the first existence proof for solutions of differential equations, gave the first proof of the convergence of a Taylor series, and was the first to feel the need for a careful study of the convergence behavior of Fourier series (see Chap. 9). However, his most important work was in the theory of functions of a complex variable, which in essence he created and which has continued to be one of the dominant branches of both pure and applied mathematics. In this field, Cauchy's integral theorem and Cauchy's integral formula are fundamental tools without which modern analysis could hardly exist (see Chap. 10).

Unfortunately, his personality did not harmonize with the fruitful power of his mind. He was an arrogant royalist in politics and a self-righteous, preaching, pious believer in religion—all this in an age of republican skepticism—and most of his fellow scientists disliked him and considered him a smug hypocrite. It might be fairer to put first things first and describe him as a great mathematician who happened also to be a sincere but narrow-minded bigot.



Augustin-Louis Cauchy
1789–1857

Definition 10.2.6 A function $f : \mathbb{C} \rightarrow \mathbb{C}$ is called **analytic** at z_0 if it is differentiable at z_0 and at all other points in some neighborhood of z_0 . A point at which f is analytic is called a **regular point** of f . A point at which f is not analytic is called a **singular point** or a **singularity** of f . A function for which all points in \mathbb{C} are regular is called an **entire** function.

analyticity and singularity; regular and singular points; entire functions

Example 10.2.7 (Derivatives of some functions)

- $f(z) = z$. Here $u = x$ and $v = y$; the C-R conditions are easily shown to hold, and for any z , we have $df/dz = \partial u/\partial x + i\partial v/\partial x = 1$. Therefore, the derivative exists at all points of the complex plane.
- $f(z) = z^2$. Here $u = x^2 - y^2$ and $v = 2xy$; the C-R conditions hold, and for all points z of the complex plane, we have $df/dz = \partial u/\partial x + i\partial v/\partial x = 2x + i2y = 2z$. Therefore, $f(z)$ is differentiable at all points.
- $f(z) = z^n$ for $n \geq 1$. We can use mathematical induction and the fact that the product of two entire functions is an entire function to show that $\frac{d}{dz}(z^n) = nz^{n-1}$.
- $f(z) = a_0 + a_1z + \cdots + a_{n-1}z^{n-1} + a_nz^n$, where a_i are arbitrary constants. That $f(z)$ is entire follows directly from (c) and the fact that the sum of two entire functions is entire.

- (e) $f(z) = 1/z$. The derivative can be found to be $f'(z) = -1/z^2$, which does not exist for $z = 0$. Thus, $z = 0$ is a singularity of $f(z)$. However, any other point of the complex plane is a regular point of f .
- (f) $f(z) = |z|^2$. Using the definition of the derivative, we obtain

$$\begin{aligned}\frac{\Delta f}{\Delta z} &= \frac{|z + \Delta z|^2 - |z|^2}{\Delta z} = \frac{(z + \Delta z)(z^* + \Delta z^*) - zz^*}{\Delta z} \\ &= z^* + \Delta z^* + z \frac{\Delta z^*}{\Delta z}.\end{aligned}$$

For $z = 0$, $\Delta f/\Delta z = \Delta z^*$, which goes to zero as $\Delta z \rightarrow 0$. Therefore, $df/dz = 0$ at $z = 0$.⁴ However, if $z \neq 0$, the limit of $\Delta f/\Delta z$ will depend on how z is approached. Thus, df/dz does not exist if $z \neq 0$. This shows that $|z|^2$ is differentiable only at $z = 0$ and nowhere else in its neighborhood. It also shows that even if the real (here, $u = x^2 + y^2$) and imaginary (here, $v = 0$) parts of a complex function have continuous partial derivatives of all orders at a point, the function may not be differentiable there.

- (g) $f(z) = 1/\sin z$: This gives $df/dz = -\cos z/\sin^2 z$. Thus, f has infinitely many (isolated) singular points at $z = \pm n\pi$ for $n = 0, 1, 2, \dots$

complex exponential
function

Example 10.2.8 (The complex exponential function) In this example, we find the (unique) function $f : \mathbb{C} \rightarrow \mathbb{C}$ that has the following three properties:

- (a) f is single-valued and analytic for all z ,
 (b) $df/dz = f(z)$, and
 (c) $f(z_1 + z_2) = f(z_1)f(z_2)$.

Property (b) shows that if $f(z)$ is well behaved, then df/dz is also well behaved. In particular, if $f(z)$ is defined for all values of z , then f must be entire.

For $z_1 = 0 = z_2$, property (c) yields $f(0) = [f(0)]^2 \Rightarrow f(0) = 1$, or $f(0) = 0$. On the other hand,

$$\begin{aligned}\frac{df}{dz} &= \lim_{\Delta z \rightarrow 0} \frac{f(z + \Delta z) - f(z)}{\Delta z} \\ &= \lim_{\Delta z \rightarrow 0} \frac{f(z)f(\Delta z) - f(z)}{\Delta z} = f(z) \lim_{\Delta z \rightarrow 0} \frac{f(\Delta z) - 1}{\Delta z}.\end{aligned}$$

Property (b) now implies that

$$\lim_{\Delta z \rightarrow 0} \frac{f(\Delta z) - 1}{\Delta z} = 1 \Rightarrow f'(0) = 1 \quad \text{and} \quad f(0) = 1.$$

The first implication follows from the definition of derivative, and the second from the fact that the only other choice, namely $f(0) = 0$, would yield $-\infty$ for the limit.

⁴Although the derivative of $|z|^2$ exists at $z = 0$, it is not analytic there (or anywhere else). To be analytic at a point, a function must have derivatives at *all points* in some neighborhood of the given point.

Now, we write $f(z) = u(x, y) + iv(x, y)$, for which property (b) becomes

$$\frac{\partial u}{\partial x} + i \frac{\partial v}{\partial x} = u + iv \Rightarrow \frac{\partial u}{\partial x} = u, \quad \frac{\partial v}{\partial x} = v.$$

These equations have the most general solution $u(x, y) = a(y)e^x$ and $v(x, y) = b(y)e^x$, where $a(y)$ and $b(y)$ are the “constants” of integration. The Cauchy-Riemann conditions now yield $a(y) = db/dy$ and $da/dy = -b(y)$, whose most general solution is $a(y) = A \cos y + B \sin y$, $b(y) = A \sin y - B \cos y$. On the other hand, $f(0) = 1$ yields $u(0, 0) = 1$ and $v(0, 0) = 0$, implying that $a(0) = 1$, $b(0) = 0$ or $A = 1$, $B = 0$. We therefore conclude that

$$f(z) = a(y)e^x + ib(y)e^x = e^x(\cos y + i \sin y) = e^x e^{iy} = e^z.$$

Both e^x and e^{iy} are well-defined in the entire complex plane. Hence, e^z is defined and differentiable over all \mathbb{C} ; therefore, it is entire.

Example 10.2.7 shows that any polynomial in z is entire. Example 10.2.8 shows that the exponential function e^z is also entire. Therefore, any product and/or sum of polynomials and e^z will also be entire. We can build other entire functions. For instance, e^{iz} and e^{-iz} are entire functions; therefore, the trigonometric functions, defined as

trigonometric functions

$$\sin z = \frac{e^{iz} - e^{-iz}}{2i} \quad \text{and} \quad \cos z = \frac{e^{iz} + e^{-iz}}{2}, \quad (10.4)$$

are also entire functions. Problem 10.5 shows that $\sin z$ and $\cos z$ have only *real* zeros. The hyperbolic functions can be defined similarly:

hyperbolic functions

$$\sinh z = \frac{e^z - e^{-z}}{2} \quad \text{and} \quad \cosh z = \frac{e^z + e^{-z}}{2}. \quad (10.5)$$

Although the sum and the product of entire functions are entire, the ratio, in general, is not. For instance, if $f(z)$ and $g(z)$ are polynomials of degrees m and n , respectively, then for $n > 0$, the ratio $f(z)/g(z)$ is not entire, because at the zeros of $g(z)$ —which always exist and we assume that it is not a zero of $f(z)$ —the derivative is not defined.

The functions $u(x, y)$ and $v(x, y)$ of an analytic function have an interesting property that the following example investigates.

Example 10.2.9 The family of curves $u(x, y) = \text{constant}$ is perpendicular to the family of curves $v(x, y) = \text{constant}$ at each point of the complex plane where $f(z) = u + iv$ is analytic.

This can easily be seen by looking at the normal to the curves. The normal to the curve $u(x, y) = \text{constant}$ is simply $\nabla u = (\partial u/\partial x, \partial u/\partial y)$. Similarly, the normal to the curve $v(x, y) = \text{constant}$ is $\nabla v = (\partial v/\partial x, \partial v/\partial y)$. Taking the dot product of these two normals, we obtain

$$(\nabla u) \cdot (\nabla v) = \frac{\partial u}{\partial x} \frac{\partial v}{\partial x} + \frac{\partial u}{\partial y} \frac{\partial v}{\partial y} = \frac{\partial u}{\partial x} \left(-\frac{\partial u}{\partial y} \right) + \frac{\partial u}{\partial y} \left(\frac{\partial u}{\partial x} \right) = 0$$

by the C-R conditions.

10.3 Conformal Maps

The real and imaginary parts of an analytic function separately satisfy the two-dimensional Laplace's equation:

$$\frac{\partial^2 u}{\partial x^2} + \frac{\partial^2 u}{\partial y^2} = 0, \quad \frac{\partial^2 v}{\partial x^2} + \frac{\partial^2 v}{\partial y^2} = 0. \quad (10.6)$$

This can easily be verified from the C-R conditions.

Laplace's equation in three dimensions,

$$\frac{\partial^2 \Phi}{\partial x^2} + \frac{\partial^2 \Phi}{\partial y^2} + \frac{\partial^2 \Phi}{\partial z^2} = 0,$$

describes the electrostatic potential Φ in a charge-free region of space. In a typical electrostatic problem the potential Φ is given at certain boundaries (usually conducting surfaces), and its value at every point in space is sought. There are numerous techniques for solving such problems, and some of them will be discussed later in the book. However, some of these problems have a certain degree of symmetry that reduces them to two-dimensional problems. In such cases, the theory of analytic functions can be extremely helpful.

The symmetry mentioned above is cylindrical symmetry, where the potential is known a priori to be independent of the z -coordinate (the axis of symmetry). This situation occurs when conductors are cylinders and—if there are charge distributions in certain regions of space—the densities are z -independent. In such cases, $\partial\Phi/\partial z = 0$, and the problem reduces to a two-dimensional one.

harmonic functions

Functions satisfying Laplace's equation are called **harmonic functions**. Thus, the electrostatic potential is a three-dimensional harmonic function, and the potential for a cylindrically symmetric charge distribution and boundary condition is a two-dimensional harmonic function. Since the real and the imaginary parts of a complex analytic function are also harmonic, techniques of complex analysis are sometimes useful in solving electrostatic problems with cylindrical symmetry.⁵

To illustrate the connection between electrostatics and complex analysis, consider a long straight filament with a constant linear charge density λ . It is shown in introductory electromagnetism that the potential Φ (disregarding the arbitrary constant that determines the reference potential) is given, in cylindrical coordinates, by

$$\Phi = 2\lambda \ln \rho = 2\lambda \ln[(x^2 + y^2)^{1/2}] = 2\lambda \ln |z|.$$

Since Φ satisfies Laplace's equation, we conclude that Φ *could* be the real part of an analytic function $w(z)$, which we call the **complex potential**.

⁵We use electrostatics because it is more familiar to physics students. Engineering students are familiar with steady state heat transfer as well, which also involves Laplace's equation, and therefore is amenable to this technique.

Example 10.2.9, plus the fact that the curves $u = \Phi = \text{constant}$ are circles, imply that the constant- v curves are rays, i.e., $v \propto \varphi$. Choosing the constant of proportionality as 2λ , we obtain

$$w(z) = 2\lambda \ln \rho + i2\lambda\varphi = 2\lambda \ln(\rho e^{i\varphi}) = 2\lambda \ln z.$$

It is useful to know the complex potential of more than one filament of charge. To find such a potential we must first find $w(z)$ for a line charge when it is displaced from the origin. If the line is located at $z_0 = x_0 + iy_0$, then it is easy to show that $w(z) = 2\lambda \ln(z - z_0)$. If there are n line charges located at z_1, z_2, \dots, z_n , then

$$w(z) = 2 \sum_{k=1}^n \lambda_k \ln(z - z_k). \quad (10.7)$$

The function $w(z)$ can be used directly to solve a number of electrostatic problems involving simple charge distributions and conductor arrangements. Some of these are illustrated in problems at the end of this chapter. Instead of treating $w(z)$ as a complex potential, let us look at it as a map from the z -plane (or xy -plane) to the w -plane (or uv -plane). In particular, the equipotential curves (circles for a single line of charge) are mapped onto *lines parallel to the v -axis* in the w -plane. This is so because equipotential curves are defined by $u = \text{constant}$. Similarly, the constant- v curves are mapped onto horizontal lines in the w -plane.

This is an enormous simplification of the geometry. Straight lines, especially when they are parallel to axes, are by far simpler geometrical objects than circles,⁶ especially if the circles are not centered at the origin. So let us consider two complex “worlds”. One is represented by the xy -plane and denoted by z . The other, the “prime world”, is represented⁷ by z' , and its real and imaginary parts by x' and y' . We start in z , where we need to find a physical quantity such as the electrostatic potential $\Phi(x, y)$. If the problem is too complicated in the z -world, we transfer it to the z' -world, in which it may be easily solvable; we solve the problem there (in terms of x' and y') and then transfer back to the z -world (x and y). The mapping that relates z and z' must be cleverly chosen. Otherwise, there is no guarantee that the problem will simplify.

Two conditions are necessary for the above strategy to work. First, the differential equation describing the physics must not get more complicated with the transfer to z' . Since Laplace’s equation is already of the simplest type, the z' -world must also respect Laplace’s equation. Second, and more importantly, the mapping must preserve the angles between curves. This is necessary because we want the equipotential curves and the field lines to be perpendicular in both worlds. A mapping that preserves the angle between two curves at a given point is called a **conformal mapping**. We already have such mappings at our disposal, as the following proposition shows.

⁶This statement is valid only in Cartesian coordinates. But these are precisely the coordinates we are using in this discussion.

⁷We are using z' instead of w , and (x', y') instead of (u, v) .

Proposition 10.3.1 Let γ_1 and γ_2 be curves in the complex z -plane that intersect at a point z_0 at an angle α . Let $f : \mathbb{C} \rightarrow \mathbb{C}$ be a mapping given by $f(z) = z' = x' + iy'$ that is analytic at z_0 . Let γ'_1 and γ'_2 be the images of γ_1 and γ_2 under this mapping, which intersect at an angle α' . Then,

- (a) $\alpha' = \alpha$, that is, the mapping f is conformal, if $(dz'/dz)_{z_0} \neq 0$.
 (b) If f is harmonic in (x, y) , it is also harmonic in (x', y') .

Proof See Problem 10.21. □

The following are some examples of conformal mappings.

- (a) $z' = z + a$, where a is an arbitrary complex constant. This is simply a **translation** of the z -plane.
 (b) $z' = bz$, where b is an arbitrary complex constant. This is a **dilation** whereby distances are dilated by a factor $|b|$. A graph in the z -plane is mapped onto a *similar* (congruent) graph in the z' -plane that will be reduced ($|b| < 1$) or enlarged ($|b| > 1$) by a factor of $|b|$.
 (c) $z' = 1/z$. This is called an **inversion**. Example 10.3.2 will show that under such a mapping, circles are mapped onto circles or straight lines.
 (d) Combining the preceding three transformations yields the general mapping

$$z' = \frac{az + b}{cz + d}, \quad (10.8)$$

which is conformal if $cz + d \neq 0 \neq dz'/dz$. These conditions are equivalent to $ad - bc \neq 0$.

Example 10.3.2 A circle of radius r whose center is at a in the z -plane is described by the equation $|z - a| = r$. When transforming to the z' -plane under inversion, this equation becomes $|1/z' - a| = r$, or $|1 - az'| = r|z'|$. Squaring both sides and simplifying yields $(r^2 - |a|^2)|z'|^2 + 2\operatorname{Re}(az') - 1 = 0$. In terms of Cartesian coordinates, this becomes

$$(r^2 - |a|^2)(x'^2 + y'^2) + 2(a_r x' - a_i y') - 1 = 0, \quad (10.9)$$

where $a \equiv a_r + ia_i$. We now consider two cases:

1. $r \neq |a|$: Divide by $r^2 - |a|^2$ and complete the squares to get

$$\left(x' + \frac{a_r}{r^2 - |a|^2}\right)^2 + \left(y' - \frac{a_i}{r^2 - |a|^2}\right)^2 - \frac{a_r^2 + a_i^2}{(r^2 - |a|^2)^2} - \frac{1}{r^2 - |a|^2} = 0$$

or defining

$$a'_r \equiv -a_r/(r^2 - |a|^2), \\ a'_i \equiv a_i/(r^2 - |a|^2) \quad \text{and} \quad r' \equiv r/|r^2 - |a|^2|,$$

we have $(x' - a'_r)^2 + (y' - a'_i)^2 = r'^2$, which can also be written as

$$|z' - a'| = r', \quad a' = a'_r + ia'_i = \frac{a^*}{|a|^2 - r^2}.$$

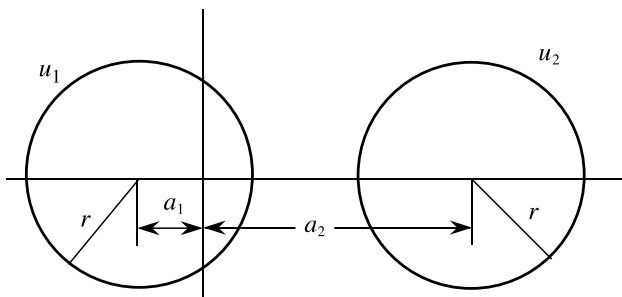

Fig. 10.3 In the z -plane, we see two equal cylinders whose centers are separated

This is a circle in the z' -plane with center at a' and radius of r' .

2. $r = a$: Then Eq. (10.9) reduces to $a_r x' - a_i y' = \frac{1}{2}$, which is the equation of a line.

If we use the transformation $z' = 1/(z - c)$ instead of $z' = 1/z$, then $|z - a| = r$ becomes $|1/z' - (a - c)| = r$, and all the above analysis will go through exactly as before, except that a is replaced by $a - c$.

Mappings of the form given in Eq. (10.8) are called **homographic transformations**. A useful property of such transformations is that they can map an infinite region of the z -plane onto a finite region of the z' -plane. In fact, points with very large values of z are mapped onto a neighborhood of the point $z' = a/c$. Of course, this argument goes both ways: Eq. (10.8) also maps a neighborhood of $-d/c$ in the z -plane onto large regions of the z' -plane. The usefulness of homographic transformations is illustrated in the following example.

homographic transformations

Example 10.3.3 Consider two cylindrical conductors of equal radius r , held at potentials u_1 and u_2 , respectively, whose centers are D units of length apart. Choose the x - and the y -axes such that the centers of the cylinders are located on the x -axis at distances a_1 and a_2 from the origin, as shown in Fig. 10.3. Let us find the electrostatic potential produced by such a configuration in the xy -plane.

electrostatic potential of two charged cylinder

We know from elementary electrostatics that the problem becomes very simple if the two cylinders are concentric (and, of course, of different radii). Thus, we try to map the two circles onto two concentric circles in the z' -plane such that the infinite region outside the two circles in the z -plane gets mapped onto the finite annular region between the two concentric circles in the z' -plane. We then (easily) find the potential in the z' -plane, and transfer it back to the z -plane.

The most general mapping that may be able to do the job is that given by Eq. (10.8). However, it turns out that we do not have to be this general. In fact, the special case $z' = 1/(z - c)$ in which c is a *real* constant will be sufficient. So, $z = (1/z') + c$, and the circles $|z - a_k| = r$ for $k = 1, 2$ will be mapped onto the circles $|z' - a'_k| = r'_k$, where (by Example 10.3.2) $a'_k = (a_k - c)/[(a_k - c)^2 - r^2]$ and $r'_k = r/|(a_k - c)^2 - r^2|$.

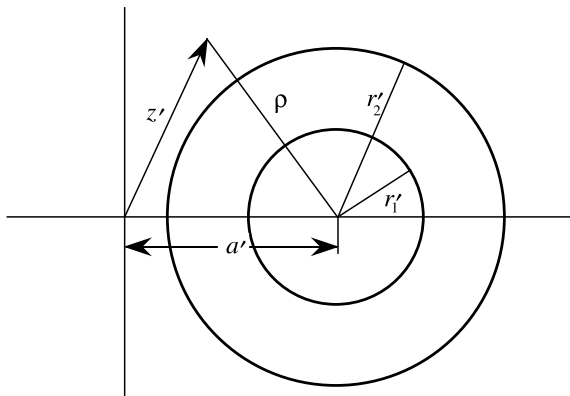

Fig. 10.4 In the z' -plane, we see two concentric unequal cylinders

Can we arrange the parameters so that the circles in the z' -plane are concentric, i.e., that $a'_1 = a'_2$? The answer is yes. We set $a'_1 = a'_2$ and solve for a_2 in terms of a_1 . The result is either the trivial solution $a_2 = a_1$, or $a_2 = c - r^2/(a_1 - c)$. If we place the origin of the z -plane at the center of the first cylinder, then $a_1 = 0$ and $a_2 = D = c + r^2/c$. We can also find a'_1 and a'_2 : $a'_1 = a'_2 \equiv a' = -c/(c^2 - r^2)$, and the geometry of the problem is as shown in Fig. 10.4.

For such a geometry the potential at a point in the annular region is given by

$$\Phi' = A \ln \rho + B = A \ln |z' - a'| + B,$$

where A and B are real constants determined by the conditions $\Phi'(r'_1) = u_1$ and $\Phi'(r'_2) = u_2$, which yields

$$A = \frac{u_1 - u_2}{\ln(r'_1/r'_2)} \quad \text{and} \quad B = \frac{u_2 \ln r'_1 - u_1 \ln r'_2}{\ln(r'_1/r'_2)}.$$

The potential Φ' is the real part of the complex function⁸

$$F(z') = A \ln(z' - a') + B,$$

which is analytic except at $z' = a'$, a point lying outside the region of interest. We can now go back to the z -plane by substituting $z' = 1/(z - c)$ to obtain

$$G(z) = A \ln\left(\frac{1}{z - c} - a'\right) + B,$$

whose real part is the potential in the z -plane:

$$\Phi(x, y) = \text{Re}[G(z)] = A \ln \left| \frac{1 - a'z + a'c}{z - c} \right| + B$$

⁸Writing $z = |z|e^{i\theta}$, we note that $\ln z = \ln |z| + i\theta$, so that the real part of a complex log function is the log of the absolute value.

$$\begin{aligned}
 &= A \ln \left| \frac{(1 + a'c - a'x) - ia'y}{(x - c) + iy} \right| + B \\
 &= \frac{A}{2} \ln \left[\frac{(1 + a'c - a'x)^2 + a'^2 y^2}{(x - c)^2 + y^2} \right] + B.
 \end{aligned}$$

This is the potential we want.

10.4 Integration of Complex Functions

The derivative of a complex function is an important concept and, as the previous section demonstrated, provides a powerful tool in physical applications. The concept of integration is even more important. In fact, we will see in the next section that derivatives can be written in terms of integrals. We will study integrals of complex functions in detail in this section.

The definite integral of a complex function is defined in analogy to that of a real function:

$$\int_{\alpha_1}^{\alpha_2} f(z) dz = \lim_{\substack{N \rightarrow \infty \\ \Delta z_i \rightarrow 0}} \sum_{i=1}^N f(z_i) \Delta z_i,$$

where Δz_i is a small segment, situated at z_i , of the curve that connects the complex number α_1 to the complex number α_2 in the z -plane. Since there are infinitely many ways of connecting α_1 to α_2 , it is possible to obtain different values for the integral for different paths. Before discussing the integral itself, let us first consider the various kinds of path encountered in complex analysis.

1. A **curve** is a map $\gamma : [a, b] \rightarrow \mathbb{C}$ from the real interval into the complex plane given by $\gamma(t) = \gamma_r(t) + i\gamma_i(t)$, where $a \leq t \leq b$, and γ_r and γ_i are the real and imaginary parts of γ ; $\gamma(a)$ is called the **initial point** of the curve and $\gamma(b)$ its **final point**. curve, simple arc, path, and smooth arc defined
2. A **simple arc**, or a Jordan arc, is a curve that does not cross itself, i.e., γ is injective (or one to one), so that $\gamma(t_1) \neq \gamma(t_2)$ when $t_1 \neq t_2$.
3. A **path** is a finite collection $\{\gamma_1, \gamma_2, \dots, \gamma_n\}$ of simple arcs such that the initial point of γ_{k+1} coincides with the final point of γ_k .
4. A **smooth arc** is a curve for which $d\gamma/dt = d\gamma_r/dt + id\gamma_i/dt$ exists and is nonzero for $t \in [a, b]$.
5. A **contour** is a path whose arcs are smooth. When the initial point of γ_1 coincides with the final point of γ_n , the contour is said to be a **simple closed contour**. contour defined

The path dependence of a complex integral is analogous to the line integral of a vector field encountered in vector analysis. In fact, we can turn the integral of a complex function into a line integral as follows. We substitute $f(z) = u + iv$ and $dz = dx + idy$ in the integral to obtain

$$\int_{\alpha_1}^{\alpha_2} f(z) dz = \int_{\alpha_1}^{\alpha_2} (u dx - v dy) + i \int_{\alpha_1}^{\alpha_2} (v dx + u dy).$$

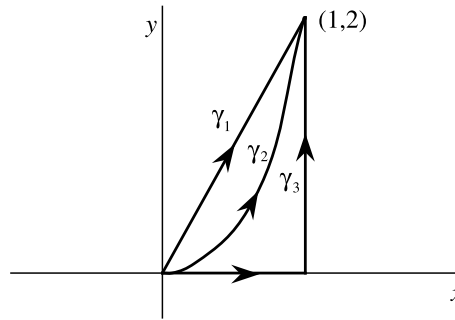

Fig. 10.5 The three different paths of integration corresponding to the integrals I_1 , I'_1 , I_2 , and I'_2

If we define the two-dimensional vectors $\mathbf{A}_1 \equiv (u, -v)$ and $\mathbf{A}_2 \equiv (v, u)$, we get

$$\int_{\alpha_1}^{\alpha_2} f(z) dz = \int_{\alpha_1}^{\alpha_2} \mathbf{A}_1 \cdot d\mathbf{r} + i \int_{\alpha_1}^{\alpha_2} \mathbf{A}_2 \cdot d\mathbf{r}.$$

It follows from Stokes' theorem (or Green's theorem, since the vectors lie in a plane) that the integral of f is path-independent only if both \mathbf{A}_1 and \mathbf{A}_2 have vanishing curls. This in turn follows if and only if u and v satisfy the C-R conditions, and this is exactly what is needed for $f(z)$ to be analytic.

Path-independence of a line integral of a vector \mathbf{A} is equivalent to the vanishing of the integral along a closed path, and the latter is equivalent to the vanishing of $\nabla \times \mathbf{A} = 0$ at every point of the region bordered by the closed path. In the case of complex integrals, this result is stated as

Cauchy-Goursat theorem **Theorem 10.4.1** (Cauchy-Goursat theorem) *Let $f : \mathbb{C} \rightarrow \mathbb{C}$ be analytic on a simple closed contour C and at all points inside C . Then*

$$\oint_C f(z) dz = 0.$$

Example 10.4.2 (Examples of definite integrals)

- (a) Let us evaluate the integral $I_1 = \int_{\gamma_1} z dz$ where γ_1 is the straight line drawn from the origin to the point $(1, 2)$ (see Fig. 10.5). Along such a line $y = 2x$ and, using t for x , $\gamma_1(t) = t + 2it$ where $0 \leq t \leq 1$; so

$$\begin{aligned} I_1 &= \int_{\gamma_1} z dz = \int_0^1 (t + 2it)(dt + 2idt) \\ &= \int_0^1 (-3tdt + 4itdt) = -\frac{3}{2} + 2i. \end{aligned}$$

For a different path γ_2 , along which $y = 2x^2$, we get $\gamma_2(t) = t + 2it^2$ where $0 \leq t \leq 1$, and

$$I'_1 = \int_{\gamma_2} z dz = \int_0^1 (t + 2it^2)(dt + 4itdt) = -\frac{3}{2} + 2i.$$

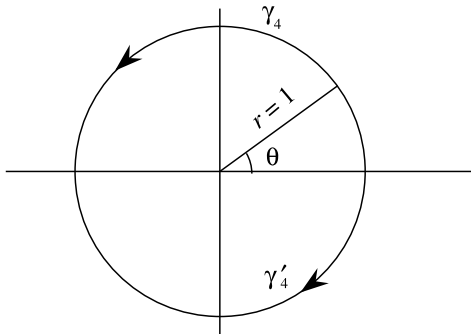

Fig. 10.6 The two semicircular paths for calculating I_3 and I'_3

Therefore, $I_1 = I'_1$. This is what is expected from the Cauchy-Goursat theorem because the function $f(z) = z$ is analytic on the two paths and in the region bounded by them.

- (b) To find $I_2 \equiv \int_{\gamma_1} z^2 dz$ with γ_1 as in part (a), substitute for z in terms of t :

$$I_2 = \int_{\gamma_1} (t + 2it)^2(dt + 2idt) = (1 + 2i)^3 \int_0^1 t^2 dt = -\frac{11}{3} - \frac{2}{3}i.$$

Next we compare I_2 with $I'_2 = \int_{\gamma_3} z^2 dz$ where γ_3 is as shown in Fig. 10.5. This path can be described by

$$\gamma_3(t) = \begin{cases} t & \text{for } 0 \leq t \leq 1, \\ 1 + i(t - 1) & \text{for } 1 \leq t \leq 3. \end{cases}$$

Therefore,

$$I'_2 = \int_0^1 t^2 dt + \int_1^3 [1 + i(t - 1)]^2 (idt) = \frac{1}{3} - 4 - \frac{2}{3}i = -\frac{11}{3} - \frac{2}{3}i,$$

which is identical to I_2 , once again because the function is analytic on γ_1 and γ_3 as well as in the region bounded by them.

- (c) Now consider $I_3 \equiv \int_{\gamma_4} dz/z$ where γ_4 is the upper semicircle of unit radius, as shown in Fig. 10.6. A parametric equation for γ_4 can be given in terms of θ :

$$\gamma_4(\theta) = \cos \theta + i \sin \theta = e^{i\theta} \Rightarrow dz = ie^{i\theta} d\theta, \quad 0 \leq \theta \leq \pi.$$

Thus, we obtain

$$I_3 = \int_0^\pi \frac{1}{e^{i\theta}} ie^{i\theta} d\theta = i\pi.$$

On the other hand, for γ'_4 , the lower semicircle of unit radius, we get

$$I'_3 = \int_{\gamma'_4} \frac{1}{z} dz = \int_{2\pi}^\pi \frac{1}{e^{i\theta}} ie^{i\theta} d\theta = -i\pi.$$

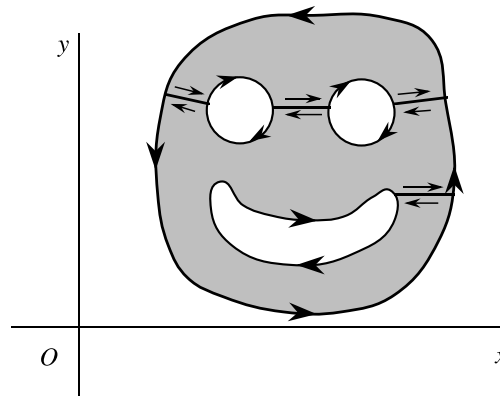

Fig. 10.7 A complicated contour can be broken up into simpler ones. Note that the boundaries of the “eyes” and the “mouth” are forced to be traversed in the (negative) clockwise direction

Here the two integrals are not equal. From γ_4 and γ_4' we can construct a counterclockwise simple closed contour C , along which the integral of $f(z) = 1/z$ becomes $\oint_C dz/z = I_3 - I_3' = 2i\pi$. That the integral is not zero is a consequence of the fact that $1/z$ is *not* analytic at all points of the region bounded by the closed contour C .

The Cauchy-Goursat theorem applies to more complicated regions. When a region contains points at which $f(z)$ is not analytic, those points can be avoided by redefining the region and the contour. Such a procedure requires an agreement on the direction we will take.

convention for positive sense of integration around a closed contour

Convention When integrating along a closed contour, we agree to move along the contour in such a way that the enclosed region lies to our left. An integration that follows this convention is called integration in the **positive sense**. Integration performed in the opposite direction acquires a minus sign.

simply and multiply connected regions
Cauchy Integral Formula (CIF)

For a simple closed contour, movement in the counterclockwise direction yields integration in the positive sense. However, as the contour becomes more complicated, this conclusion breaks down. Figure 10.7 shows a complicated path enclosing a region (shaded) in which the integrand is analytic. Note that it is possible to traverse a portion of the region twice in opposite directions without affecting the integral, which may be a sum of integrals for different pieces of the contour. Also note that the “eyes” and the “mouth” are traversed clockwise! This is necessary because of the convention above. A region such as that shown in Fig. 10.7, in which holes are “punched out”, is called **multiply connected**. In contrast, a **simply connected** region is one in which every simple closed contour encloses only points of the region.

One important consequence of the Cauchy-Goursat theorem is the following:

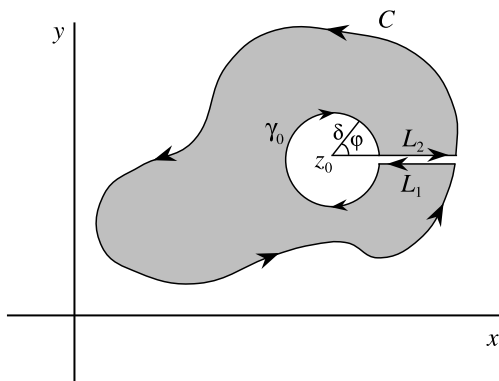

Fig. 10.8 The integrand is analytic within and on the boundary of the shaded region. It is always possible to construct contours that exclude all singular points

Theorem 10.4.3 (Cauchy integral formula) *Let f be analytic on and within a simple closed contour C integrated in the positive sense. Let z_0 be any interior point to C . Then*

$$f(z_0) = \frac{1}{2\pi i} \oint_C \frac{f(z)}{z - z_0} dz$$

To prove the Cauchy integral formula (CIF), we need the following lemma.

Lemma 10.4.4 (Darboux inequality) *Suppose $f : \mathbb{C} \rightarrow \mathbb{C}$ is continuous and bounded on a path γ , i.e., there exists a positive number M such that $|f(z)| \leq M$ for all values $z \in \gamma$. Then*

$$\left| \int_{\gamma} f(z) dz \right| \leq M L_{\gamma},$$

where L_{γ} is the length of the path of integration.

Proof See Problem 10.27. □

Now we are ready to prove the Cauchy integral formula.

Proof of CIF Consider the shaded region in Fig. 10.8, which is bounded by C , by γ_0 (a circle of arbitrarily small radius δ centered at z_0), and by L_1 and L_2 , two straight line segments infinitesimally close to one another (we can, in fact, assume that L_1 and L_2 are right on top of one another; however, they are separated in the figure for clarity). Let $C' = C \cup \gamma_0 \cup L_1 \cup L_2$.

Since $f(z)/(z - z_0)$ is analytic everywhere on the contour C' and inside the shaded region, we can write

$$0 = \oint_{C'} \frac{f(z)}{z - z_0} dz = \oint_C \frac{f(z)}{z - z_0} dz + \oint_{\gamma_0} \frac{f(z)}{z - z_0} dz \tag{10.10}$$

because the contributions from L_1 and L_2 cancel. Let us evaluate the contribution from the infinitesimal circle γ_0 . First we note that because $f(z)$ is continuous (differentiability implies continuity), we can write

$$\left| \frac{f(z) - f(z_0)}{z - z_0} \right| = \frac{|f(z) - f(z_0)|}{|z - z_0|} = \frac{|f(z) - f(z_0)|}{\delta} < \frac{\epsilon}{\delta}$$

for $z \in \gamma_0$, where ϵ is a small positive number. We now apply the Darboux inequality and write

$$\left| \oint_{\gamma_0} \frac{f(z) - f(z_0)}{z - z_0} dz \right| < \frac{\epsilon}{\delta} 2\pi\delta = 2\pi\epsilon.$$

This means that the integral goes to zero as $\delta \rightarrow 0$, or

$$\oint_{\gamma_0} \frac{f(z)}{z - z_0} dz = \oint_{\gamma_0} \frac{f(z_0)}{z - z_0} dz = f(z_0) \oint_{\gamma_0} \frac{dz}{z - z_0}.$$

We can easily calculate the integral on the RHS by noting that $z - z_0 = \delta e^{i\varphi}$ and that γ_0 has a *clockwise* direction:

$$\oint_{\gamma_0} \frac{dz}{z - z_0} = - \int_0^{2\pi} \frac{i\delta e^{i\varphi} d\varphi}{\delta e^{i\varphi}} = -2\pi i \Rightarrow \oint_{\gamma_0} \frac{f(z)}{z - z_0} dz = -2\pi i f(z_0).$$

Substituting this in (10.10) yields the desired result. \square

Example 10.4.5 We can use the CIF to evaluate the integrals

$$I_1 = \oint_{C_1} \frac{z^2 dz}{(z^2 + 3)^2 (z - i)}, \quad I_2 = \oint_{C_2} \frac{(z^2 - 1) dz}{(z - \frac{1}{2})(z^2 - 4)^3},$$

$$I_3 = \oint_{C_3} \frac{e^{z/2} dz}{(z - i\pi)(z^2 - 20)^4},$$

where C_1 , C_2 , and C_3 are circles centered at the origin with radii $r_1 = 3/2$, $r_2 = 1$, and $r_3 = 4$.

For I_1 we note that $f(z) = z^2/(z^2 + 3)^2$ is analytic within and on C_1 , and $z_0 = i$ lies in the interior of C_1 . Thus,

$$I_1 = \oint_{C_1} \frac{f(z) dz}{z - i} = 2\pi i f(i) = 2\pi i \frac{i^2}{(i^2 + 3)^2} = -i \frac{\pi}{2}.$$

Similarly, $f(z) = (z^2 - 1)/(z^2 - 4)^3$ for the integral I_2 is analytic on and within C_2 , and $z_0 = 1/2$ is an interior point of C_2 . Thus, the CIF gives

$$I_2 = \oint_{C_2} \frac{f(z) dz}{z - \frac{1}{2}} = 2\pi i f(1/2) = \frac{32\pi}{1125} i.$$

For the last integral, $f(z) = e^{z/2}/(z^2 - 20)^4$, and the interior point is $z_0 = i\pi$:

$$I_3 = \oint_{C_3} \frac{f(z) dz}{z - i\pi} = 2\pi i f(i\pi) = -\frac{2\pi}{(\pi^2 + 20)^4}.$$

The Cauchy integral formula gives the value of an analytic function at every point inside a simple closed contour when it is given the value of the function only at points on the contour. It seems as though an analytic function is not free to change inside a region once its value is fixed on the contour enclosing that region.

There is an analogous situation in electrostatics: The specification of the potential at the boundaries, such as the surfaces of conductors, automatically determines the potential at any other point in the region of space bounded by the conductors. This is the content of the uniqueness theorem used in electrostatic boundary value problems. However, the electrostatic potential Φ is bound by another condition, Laplace's equation; and the combination of Laplace's equation and the boundary conditions furnishes the uniqueness of Φ . Similarly, the real and imaginary parts of an analytic function separately satisfy Laplace's equation in two dimensions! Thus, it should come as no surprise that the value of an analytic function on a boundary (contour) determines the function at all points inside the boundary.

Explanation of why the Cauchy integral formula works!

10.5 Derivatives as Integrals

The Cauchy Integral Formula is a powerful tool for working with analytic functions. One of the applications of this formula is in evaluating the derivatives of such functions. It is convenient to change the dummy integration variable to ξ and write the CIF as

$$f(z) = \frac{1}{2\pi i} \oint_C \frac{f(\xi) d\xi}{\xi - z}, \quad (10.11)$$

where C is a simple closed contour in the ξ -plane and z is a point within C . As preparation for defining the derivative of an analytic function, we need the following result.

Proposition 10.5.1 *Let γ be any path—a contour, for example—and g a continuous function on that path. The function $f(z)$ defined by*

$$f(z) = \frac{1}{2\pi i} \int_{\gamma} \frac{g(\xi) d\xi}{\xi - z}$$

is analytic at every point $z \notin \gamma$.

Proof The proof follows immediately from differentiation of the integral:

$$\begin{aligned} \frac{df}{dz} &= \frac{1}{2\pi i} \frac{d}{dz} \int_{\gamma} \frac{g(\xi) d\xi}{\xi - z} \\ &= \frac{1}{2\pi i} \int_{\gamma} g(\xi) d\xi \frac{d}{dz} \left(\frac{1}{\xi - z} \right) = \frac{1}{2\pi i} \int_{\gamma} \frac{g(\xi) d\xi}{(\xi - z)^2}. \end{aligned}$$

This is defined for all values of z not on γ .⁹ Thus, $f(z)$ is analytic there. \square

We can generalize the formula above to the n th derivative, and obtain

$$\frac{d^n f}{dz^n} = \frac{n!}{2\pi i} \int_{\gamma} \frac{g(\xi) d\xi}{(\xi - z)^{n+1}}.$$

Applying this result to an analytic function expressed by Eq. (10.11), we obtain the following important theorem.

derivative of an analytic function given in terms of an integral

Theorem 10.5.2 *The derivatives of all orders of an analytic function $f(z)$ exist in the domain of analyticity of the function and are themselves analytic in that domain. The n th derivative of $f(z)$ is given by*

$$f^{(n)}(z) = \frac{d^n f}{dz^n} = \frac{n!}{2\pi i} \oint_C \frac{f(\xi) d\xi}{(\xi - z)^{n+1}}. \quad (10.12)$$

Example 10.5.3 Let us apply Eq. (10.12) directly to some simple functions. In all cases, we will assume that the contour is a circle of radius r centered at z .

(a) Let $f(z) = K$, a constant. Then, for $n = 1$ we have

$$\frac{df}{dz} = \frac{1}{2\pi i} \oint_C \frac{K d\xi}{(\xi - z)^2}.$$

Since ξ is on the circle C centered at z , $\xi - z = re^{i\theta}$ and $d\xi = rie^{i\theta} d\theta$. So we have

$$\frac{df}{dz} = \frac{1}{2\pi i} \int_0^{2\pi} \frac{Kire^{i\theta} d\theta}{(re^{i\theta})^2} = \frac{K}{2\pi r} \int_0^{2\pi} e^{-i\theta} d\theta = 0.$$

(b) Given $f(z) = z$, its first derivative will be

$$\begin{aligned} \frac{df}{dz} &= \frac{1}{2\pi i} \oint_C \frac{\xi d\xi}{(\xi - z)^2} = \frac{1}{2\pi i} \int_0^{2\pi} \frac{(z + re^{i\theta})ire^{i\theta} d\theta}{(re^{i\theta})^2} \\ &= \frac{1}{2\pi} \left(\frac{z}{r} \int_0^{2\pi} e^{-i\theta} d\theta + \int_0^{2\pi} d\theta \right) = \frac{1}{2\pi} (0 + 2\pi) = 1. \end{aligned}$$

(c) Given $f(z) = z^2$, for the first derivative, Eq. (10.12) yields

$$\begin{aligned} \frac{df}{dz} &= \frac{1}{2\pi i} \oint_C \frac{\xi^2 d\xi}{(\xi - z)^2} = \frac{1}{2\pi i} \int_0^{2\pi} \frac{(z + re^{i\theta})^2 ire^{i\theta} d\theta}{(re^{i\theta})^2} \\ &= \frac{1}{2\pi} \int_0^{2\pi} [z^2 + (re^{i\theta})^2 + 2zre^{i\theta}] (re^{i\theta})^{-1} d\theta \end{aligned}$$

⁹The interchange of differentiation and integration requires justification. Such an interchange can be done if the integral has some restrictive properties. We shall not concern ourselves with such details. In fact, one can achieve the same result by using the definition of derivatives and the usual properties of integrals.

$$= \frac{1}{2\pi} \left(\frac{z^2}{r} \int_0^{2\pi} e^{-i\theta} d\theta + r \int_0^{2\pi} e^{i\theta} d\theta + 2z \int_0^{2\pi} d\theta \right) = 2z.$$

It can be shown that, in general, $(d/dz)z^m = mz^{m-1}$. The proof is left as Problem 10.30.

The CIF is a central formula in complex analysis, and we shall see its significance in much of the later development of complex analysis. For now, let us demonstrate its usefulness in proving a couple of important properties of analytic functions.

Proposition 10.5.4 *The absolute value of an analytic function $f(z)$ cannot have a local maximum within the region of analyticity of the function.*

Proof Let $S \subset \mathbb{C}$ be the region of analyticity of f and z_0 a point in S . Let γ_0 be a circle of radius δ in S , centered at z_0 . Using the CIF, and noting that $z - z_0 = \delta e^{i\theta}$, we have

$$\begin{aligned} |f(z_0)| &= \left| \frac{1}{2\pi i} \oint_{\gamma_0} \frac{f(z)}{z - z_0} dz \right| = \frac{1}{2\pi} \left| \int_0^{2\pi} \frac{f(z)}{\delta e^{i\theta}} i \delta e^{i\theta} d\theta \right| \\ &\leq \frac{1}{2\pi} \int_0^{2\pi} |f(z)| d\theta \leq \frac{1}{2\pi} \int_0^{2\pi} |f(z_{\max})| d\theta = |f(z_{\max})|, \end{aligned}$$

where z_{\max} is where the maximum value of $|f(z)|$ occurs on γ_0 . This inequality says that for any point z_0 that one picks, there is always another point which produces a larger absolute value for f . Therefore, there can be no local maximum within S . \square

Proposition 10.5.5 *A bounded entire function is necessarily a constant.*

Proof We show that the derivative of such a function is zero. Consider

$$\frac{df}{dz} = \frac{1}{2\pi i} \oint_C \frac{f(\xi) d\xi}{(\xi - z)^2}.$$

Since f is an entire function, the closed contour C can be chosen to be a very large circle of radius R with center at z . Taking the absolute value of both sides yields

$$\begin{aligned} \left| \frac{df}{dz} \right| &= \frac{1}{2\pi} \left| \int_0^{2\pi} \frac{f(z)}{(Re^{i\theta})^2} i R e^{i\theta} d\theta \right| \\ &\leq \frac{1}{2\pi} \int_0^{2\pi} \frac{|f(z)|}{R} d\theta \leq \frac{1}{2\pi} \int_0^{2\pi} \frac{M}{R} d\theta = \frac{M}{R}, \end{aligned}$$

where M is the maximum of the function in the complex plane. Now, as $R \rightarrow \infty$, the derivative goes to zero, and the function must be a constant. \square

Proposition 10.5.5 is a very powerful statement about analytic functions. There are many interesting and nontrivial *real* functions that are bounded and have derivatives of all orders on the entire real line. For instance, e^{-x^2}

is such a function. No such freedom exists for *complex* analytic functions. Any nontrivial analytic function is either not bounded (goes to infinity somewhere on the complex plane) or not entire (it is not analytic at some point(s) of the complex plane).

A consequence of Proposition 10.5.5 is the following

fundamental theorem of algebra

Theorem 10.5.6 (Fundamental theorem of algebra) *Any polynomial*

$$p(x) = a_0 + a_1x + \cdots + a_nx^n, \quad a_n \neq 0$$

can be factored completely as

$$p(x) = a_n(x - z_1)(x - z_2) \cdots (x - z_n),$$

where the z_i are complex numbers.

Proof Let $f(z) = 1/p(z)$ and assume the contrary, i.e., that $p(z)$ is never zero for any (finite) $z \in \mathbb{C}$. Then $f(z)$ is bounded and analytic for all $z \in \mathbb{C}$, and Proposition 10.5.5 says that $f(z)$ is a constant. This is obviously wrong if $n > 0$. Thus, there must be at least one z , say $z = z_1$, for which $p(z)$ is zero. So, we can factor out $(z - z_1)$ from $p(z)$ and write $p(z) = (z - z_1)q(z)$ where $q(z)$ is of degree $n - 1$. Applying the above argument to $q(z)$, we have $p(z) = (z - z_1)(z - z_2)r(z)$ where $r(z)$ is of degree $n - 2$. Continuing in this way, we can factor $p(z)$ into linear factors. The last polynomial will be a constant (a polynomial of degree zero) which has to be equal to a_n to make the coefficient of z^n equal to the original polynomial. \square

The primitive (indefinite integral) of an analytic function can be defined using definite integrals just as in the real case. Let $f : \mathbb{C} \rightarrow \mathbb{C}$ be analytic in a region S of the complex plane. Let z_0 and z be two points in S , and define¹⁰ $F(z) \equiv \int_{z_0}^z f(\xi) d\xi$. We can show that $F(z)$ is the primitive of $f(z)$ by showing that

$$\lim_{\Delta z \rightarrow 0} \left| \frac{F(z + \Delta z) - F(z)}{\Delta z} - f(z) \right| = 0.$$

We leave the details as a problem for the reader.

Proposition 10.5.7 *Let $f : \mathbb{C} \rightarrow \mathbb{C}$ be analytic in a region S of \mathbb{C} . Then at every point $z \in S$, there exists an analytic function $F : \mathbb{C} \rightarrow \mathbb{C}$ such that*

$$\frac{dF}{dz} = f(z).$$

¹⁰Note that the integral is path-independent due to the analyticity of f . Thus, F is well-defined.

In the sketch of the proof of Proposition 10.5.7, we used only the continuity of f and the fact that the integral was well-defined. These two conditions are sufficient to establish the analyticity of F and f , since the latter is the derivative of the former. The following theorem, due to Morera, states this fact and is the converse of the Cauchy-Goursat theorem.

Theorem 10.5.8 (Morera’s theorem) *Let a function $f : \mathbb{C} \rightarrow \mathbb{C}$ be continuous in a simply connected region S . If for each simple closed contour C in S we have $\oint_C f(\xi) d\xi = 0$, then f is analytic throughout S .* Morera’s theorem

10.6 Infinite Complex Series

The expansion of functions in terms of polynomials or monomials is important in calculus and was emphasized in Chaps. 7 and 8. We now apply this concept to analytic functions.

10.6.1 Properties of Series

Complex series are very similar to real series with which the reader is assumed to have some familiarity. Therefore, we state (without proof) the most important properties of complex series before discussing the quintessential Taylor and Laurent series.

A complex series is said to **converge absolutely** if the *real* series absolute convergence

$$\sum_{k=0}^{\infty} |z_k| = \sum_{k=0}^{\infty} \sqrt{x_k^2 + y_k^2}$$

converges. Clearly, absolute convergence implies convergence.

Proposition 10.6.1 *If the power series $\sum_{k=0}^{\infty} a_k(z - z_0)^k$ converges for $z_1 \neq z_0$, then it converges absolutely for every value of z such that $|z - z_0| < |z_1 - z_0|$. Similarly if the power series $\sum_{k=0}^{\infty} b_k/(z - z_0)^k$ converges for $z_2 \neq z_0$, then it converges absolutely for every value of z such that $|z - z_0| > |z_2 - z_0|$.* power series

A geometric interpretation of this proposition is that if a power series—with positive powers—converges for a point at a distance r_1 from z_0 , then it converges for *all interior* points of the circle whose center is z_0 , and whose radius is r_1 . Similarly, if a power series—with negative powers—converges for a point at a distance r_2 from z_0 , then it converges for *all exterior* points of the circle whose center is z_0 and whose radius is r_2 (see Fig. 10.9). Generally speaking, positive powers are used for points inside a circle and negative powers for points outside it.

The largest circle about z_0 such that the first power series of Proposition 10.6.1 converges is called the **circle of convergence** of the power series. circle of convergence

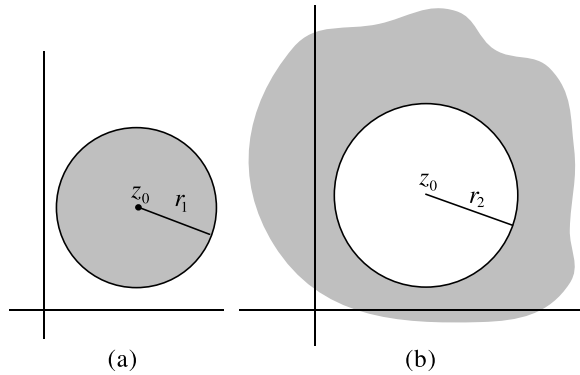

Fig. 10.9 (a) Power series with positive exponents converge for the interior points of a circle. (b) Power series with negative exponents converge for the exterior points of a circle

The proposition implies that the series cannot converge at *any* point outside the circle of convergence.

In determining the convergence of a power series

$$S(z) \equiv \sum_{n=0}^{\infty} a_n(z - z_0)^n, \tag{10.13}$$

we look at the behavior of the sequence of partial sums

$$S_N(z) \equiv \sum_{n=0}^N a_n(z - z_0)^n.$$

Convergence of (10.13) implies that for any $\varepsilon > 0$, there exists an integer N_ε such that

$$|S(z) - S_N(z)| < \varepsilon \quad \text{whenever } N > N_\varepsilon.$$

In general, the integer N_ε may be dependent on z ; that is, for different values of z , we may be forced to pick different N_ε 's. When N_ε is independent of z , we say that the convergence is **uniform**.

power series are uniformly convergent and analytic

Theorem 10.6.2 *The power series $S(z) = \sum_{n=0}^{\infty} a_n(z - z_0)^n$ is **uniformly** convergent for all points within its circle of convergence and represents a function that is analytic there.*

By substituting the reciprocal of $(z - z_0)$ in the power series, we can show that if $\sum_{k=0}^{\infty} b_k/(z - z_0)^k$ is convergent in the annulus $r_2 < |z - z_0| < r_1$, then it is uniformly convergent for all z in that annulus.

power series can be differentiated and integrated term by term

Theorem 10.6.3 *A convergent power series can be differentiated and integrated term by term; that is, if $S(z) = \sum_{n=0}^{\infty} a_n(z - z_0)^n$, then*

$$\frac{dS(z)}{dz} = \sum_{n=1}^{\infty} n a_n (z - z_0)^{n-1}, \quad \int_{\gamma} S(z) dz = \sum_{n=0}^{\infty} a_n \int_{\gamma} (z - z_0)^n dz$$

for any path γ lying in the circle of convergence of the power series.

10.6.2 Taylor and Laurent Series

We now state and prove the two main theorems of this section. A Taylor series consists of terms with only positive powers. A Laurent series allows for negative powers as well.

Theorem 10.6.4 (Taylor series) *Let f be analytic throughout the interior of a circle C_0 having radius r_0 and centered at z_0 . Then at each point z inside C_0 ,*

$$f(z) = f(z_0) + f'(z_0)(z - z_0) + \dots = \sum_{n=0}^{\infty} \frac{f^{(n)}(z_0)}{n!} (z - z_0)^n. \quad (10.14)$$

Proof From the CIF and the fact that z is inside C_0 , we have

$$f(z) = \frac{1}{2\pi i} \oint_{C_0} \frac{f(\xi)}{\xi - z} d\xi.$$

On the other hand,

$$\begin{aligned} \frac{1}{\xi - z} &= \frac{1}{\xi - z_0 + z_0 - z} = \frac{1}{(\xi - z_0)\left(1 - \frac{z - z_0}{\xi - z_0}\right)} \\ &= \frac{1}{\xi - z_0} \frac{1}{1 - \frac{z - z_0}{\xi - z_0}} = \frac{1}{\xi - z_0} \sum_{n=0}^{\infty} \left(\frac{z - z_0}{\xi - z_0}\right)^n. \end{aligned}$$

The last equality follows from the fact that $|(z - z_0)/(\xi - z_0)| < 1$ —because z is inside the circle C_0 and ξ is on it—and from the sum of a geometric series. Substituting in the CIF and using Theorem 10.5.2, we obtain the result. \square

For $z_0 = 0$ we obtain the **Maclaurin series**:

Maclaurin series

$$f(z) = f(0) + f'(0)z + \dots = \sum_{n=0}^{\infty} \frac{f^{(n)}(0)}{n!} z^n.$$

The Taylor expansion requires analyticity of the function at all points interior to the circle C_0 . On many occasions there may be a point inside C_0 at which the function is not analytic. The Laurent series accommodates such cases.

Theorem 10.6.5 (Laurent series) *Let C_1 and C_2 be circles of radii r_1 and r_2 , both centered at z_0 in the z -plane with $r_1 > r_2$. Let $f : \mathbb{C} \rightarrow \mathbb{C}$*

Laurent series

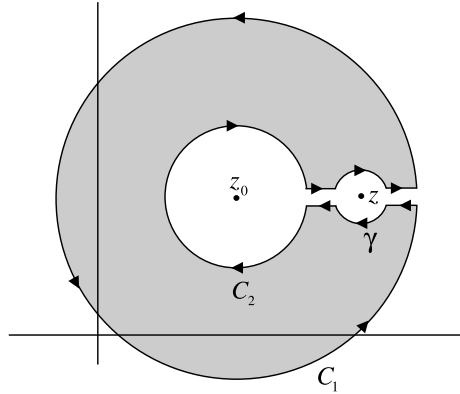

Fig. 10.10 The annular region within and on whose contour the expanded function is analytic

be analytic on C_1 and C_2 and throughout S , the annular region between the two circles. Then, at each point $z \in S$, $f(z)$ is given by

$$f(z) = \sum_{n=-\infty}^{\infty} a_n (z - z_0)^n \quad \text{where} \quad a_n = \frac{1}{2\pi i} \oint_C \frac{f(\xi)}{(\xi - z_0)^{n+1}} d\xi$$

and C is any contour within S that encircles z_0 .

Proof Let γ be a small closed contour in S enclosing z , as shown in Fig. 10.10. For the composite contour $C' = C_1 \cup C_2 \cup \gamma$, the Cauchy-Goursat theorem gives

$$0 = \oint_{C'} \frac{f(\xi)}{\xi - z} d\xi = \oint_{C_1} \frac{f(\xi)}{\xi - z} d\xi - \oint_{C_2} \frac{f(\xi)}{\xi - z} d\xi - \oint_{\gamma} \frac{f(\xi)}{\xi - z} d\xi,$$

where the γ and C_2 integrations are negative because their interior lies to our right as we traverse them. The γ integral is simply $2\pi i f(z)$ by the CIF. Thus, we obtain

$$2\pi i f(z) = \oint_{C_1} \frac{f(\xi)}{\xi - z} d\xi - \oint_{C_2} \frac{f(\xi)}{\xi - z} d\xi. \quad (10.15)$$

Now we use the same trick we used in deriving the Taylor expansion. Since z is located in the annular region, $r_2 < |z - z_0| < r_1$. We have to keep this in mind when expanding the fractions. In particular, for $\xi \in C_1$ we want the ξ term to be in the denominator, and for $\xi \in C_2$ we want it to be in the numerator. Substituting such expansions in Eq. (10.15) yields

$$\begin{aligned} 2\pi i f(z) &= \sum_{n=0}^{\infty} (z - z_0)^n \oint_{C_1} \frac{f(\xi) d\xi}{(\xi - z_0)^{n+1}} \\ &\quad + \sum_{n=0}^{\infty} \frac{1}{(z - z_0)^{n+1}} \oint_{C_2} f(\xi) (\xi - z_0)^n d\xi. \end{aligned} \quad (10.16)$$

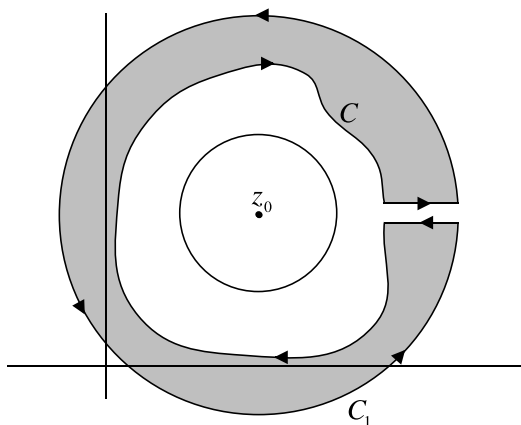

Fig. 10.11 The arbitrary contour in the annular region used in the Laurent expansion. The break in C and the gap in the shaded region are magnified for visual clarity

Now we consider an arbitrary contour C in S that encircles z_0 . Figure 10.11 shows a region bounded by a contour composed of C_1 and C . In this region $f(\xi)/(\xi - z_0)^{n+1}$ is analytic (because ξ can never equal z_0). Thus, the integral over the composite contour must vanish by the Cauchy-Goursat theorem. It follows that the integral over C_1 is equal to that over C . A similar argument shows that the C_2 integral can also be replaced by an integral over C . We let $n + 1 = -m$ in the second sum of Eq. (10.16) to transform it into

$$\begin{aligned} & \sum_{m=-1}^{-\infty} \frac{1}{(z - z_0)^{-m}} \oint_C f(\xi)(\xi - z_0)^{-m-1} d\xi \\ &= \sum_{m=-\infty}^{-1} (z - z_0)^m \oint_C \frac{f(\xi) d\xi}{(\xi - z_0)^{m+1}}. \end{aligned}$$

Changing the dummy index back to n and substituting the result in Eq. (10.16) yields

$$\begin{aligned} 2\pi i f(z) &= \sum_{n=0}^{\infty} (z - z_0)^n \oint_C \frac{f(\xi)}{(\xi - z_0)^{n+1}} d\xi \\ &+ \sum_{n=-\infty}^{-1} (z - z_0)^n \oint_C \frac{f(\xi)}{(\xi - z_0)^{n+1}} d\xi. \end{aligned}$$

We can now combine the sums and divide both sides by $2\pi i$ to get the desired expansion. \square

The Laurent expansion is convergent as long as $r_2 < |z - z_0| < r_1$. In particular, if $r_2 = 0$, and if the function is analytic throughout the interior of the larger circle, then a_n will be zero for $n = -1, -2, \dots$ because $f(\xi)/(\xi - z_0)^{n+1}$ will be analytic for negative n , and the integral will be zero by the

Cauchy-Goursat theorem. Thus, only positive powers of $(z - z_0)$ will be present in the series, and we recover the Taylor series, as we should.

It is clear that we can expand C_1 and shrink C_2 until we encounter a point at which f is no longer analytic. This is obvious from the construction of the proof, in which only the analyticity in the annular region is important, not its size. Thus, we can include all the possible analytic points by expanding C_1 and shrinking C_2 .

Example 10.6.6 Let us expand some functions in terms of series. For an entire function there is no point in the entire complex plane at which it is not analytic. Thus, only positive powers of $(z - z_0)$ will be present, and we will have a Taylor expansion that is valid for all values of z .

- (a) Let us expand e^z around $z_0 = 0$. The n th derivative of e^z is e^z . Thus, $f^{(n)}(0) = 1$, and Taylor (Maclaurin) expansion gives

$$e^z = \sum_{n=0}^{\infty} \frac{f^{(n)}(0)}{n!} z^n = \sum_{n=0}^{\infty} \frac{z^n}{n!}.$$

- (b) The Maclaurin series for $\sin z$ is obtained by noting that

$$\left. \frac{d^n}{dz^n} \sin z \right|_{z=0} = \begin{cases} 0 & \text{if } n \text{ is even,} \\ (-1)^{(n-1)/2} & \text{if } n \text{ is odd} \end{cases}$$

and substituting this in the Maclaurin expansion:

$$\sin z = \sum_{n \text{ odd}} (-1)^{(n-1)/2} \frac{z^n}{n!} = \sum_{k=0}^{\infty} (-1)^k \frac{z^{2k+1}}{(2k+1)!}.$$

Similarly, we can obtain

$$\begin{aligned} \cos z &= \sum_{k=0}^{\infty} (-1)^k \frac{z^{2k}}{(2k)!}, & \sinh z &= \sum_{k=0}^{\infty} \frac{z^{2k+1}}{(2k+1)!}, \\ \cosh z &= \sum_{k=0}^{\infty} \frac{z^{2k}}{(2k)!}. \end{aligned}$$

- (c) The function $1/(1+z)$ is not entire, so the region of its convergence is limited. Let us find the Maclaurin expansion of this function. The function is analytic within all circles of radii $r < 1$. At $r = 1$ we encounter a singularity, the point $z = -1$. Thus, the series converges for all points¹¹ z for which $|z| < 1$. For such points we have

$$f^{(n)}(0) = \left. \frac{d^n}{dz^n} [(1+z)^{-1}] \right|_{z=0} = (-1)^n n!.$$

¹¹As remarked before, the series diverges for *all* points outside the circle $|z| = 1$. This does not mean that the function cannot be represented by a series for points outside the circle. On the contrary, we shall see shortly that Laurent series, with *negative* powers of $z - z_0$ are designed precisely for such a purpose.

Thus,

$$\frac{1}{1+z} = \sum_{n=0}^{\infty} \frac{f^{(n)}(0)}{n!} z^n = \sum_{n=0}^{\infty} (-1)^n z^n.$$

Taylor and Laurent series allow us to express an analytic function as a power series. For a Taylor series of $f(z)$, the expansion is routine because the coefficient of its n th term is simply $f^{(n)}(z_0)/n!$, where z_0 is the center of the circle of convergence. When a Laurent series is applicable, however, the n th coefficient is not, in general, easy to evaluate. Usually it can be found by inspection and certain manipulations of other known series. But if we use such an intuitive approach to determine the coefficients, can we be sure that we have obtained the correct Laurent series? The following theorem answers this question.

Laurent series is unique

Theorem 10.6.7 *If the series $\sum_{n=-\infty}^{\infty} a_n(z - z_0)^n$ converges to $f(z)$ at all points in some annular region about z_0 , then it is the unique Laurent series expansion of $f(z)$ in that region.*

Proof Multiply both sides of $f(z) = \sum_{n=-\infty}^{\infty} a_n(z - z_0)^n$ by

$$\frac{1}{2\pi i (z - z_0)^{k+1}},$$

integrate the result along a contour C in the annular region, and use the easily verifiable fact that

$$\frac{1}{2\pi i} \oint_C \frac{dz}{(z - z_0)^{k-n+1}} = \delta_{kn}$$

to obtain

$$\frac{1}{2\pi i} \oint_C \frac{f(z)}{(z - z_0)^{k+1}} dz = a_k.$$

Thus, the coefficient in the power series of f is precisely the coefficient in the Laurent series, and the two must be identical. \square

We will look at some examples that illustrate the abstract ideas developed in the preceding collection of theorems and propositions. However, we can consider a much broader range of examples if we know the arithmetic of power series. The following theorem about arithmetical manipulations with power series is not difficult to prove (see [Chur 74]).

Theorem 10.6.8 *Let the two power series*

$$f(z) = \sum_{n=-\infty}^{\infty} a_n(z - z_0)^n \quad \text{and} \quad g(z) = \sum_{n=-\infty}^{\infty} b_n(z - z_0)^n$$

You can add, subtract, and multiply convergent power series

be convergent within some annular region $r_2 < |z - z_0| < r_1$. Then

$$f(z) + g(z) = \sum_{n=-\infty}^{\infty} (a_n + b_n)(z - z_0)^n$$

and

$$f(z)g(z) = \sum_{n=-\infty}^{\infty} \sum_{m=-\infty}^{\infty} a_n b_m (z - z_0)^{m+n} \equiv \sum_{k=-\infty}^{\infty} c_k (z - z_0)^k$$

for z interior to the annular region. Furthermore, if $g(z) \neq 0$ for some neighborhood of z_0 , then the series obtained by long division of the first series by the second converges to $f(z)/g(z)$ in that neighborhood.

This theorem, in essence, says that converging power series can be manipulated as though they were finite sums (polynomials). Such manipulations are extremely useful when dealing with Taylor and Laurent expansions in which the straightforward calculation of coefficients may be tedious. The following examples illustrate the power of infinite-series arithmetic.

Example 10.6.9 To expand the function $f(z) = \frac{2+3z}{z^2+z^3}$ in a Laurent series about $z = 0$, rewrite it as

$$\begin{aligned} f(z) &= \frac{1}{z^2} \left(\frac{2+3z}{1+z} \right) = \frac{1}{z^2} \left(3 - \frac{1}{1+z} \right) = \frac{1}{z^2} \left(3 - \sum_{n=0}^{\infty} (-1)^n z^n \right) \\ &= \frac{1}{z^2} (3 - 1 + z - z^2 + z^3 - \dots) = \frac{2}{z^2} + \frac{1}{z} - 1 + z - z^2 + \dots \end{aligned}$$

This series converges for $0 < |z| < 1$. We note that negative powers of z are also present.¹² Using the notation of Theorem 10.6.5, we have $a_n = 0$ for $n \leq -3$, $a_{-2} = 2$, $a_{-1} = 1$, and $a_n = (-1)^{n+1}$ for $n \geq 0$.

Example 10.6.10 The function $f(z) = 1/(4z - z^2)$ is the ratio of two entire functions. Therefore, by Theorem 10.6.8, it is analytic everywhere except at the zeros of its denominator, $z = 0$ and $z = 4$. For the annular region (here r_2 of Theorem 10.6.5 is zero) $0 < |z| < 4$, we expand $f(z)$ in the Laurent series around $z = 0$. Instead of actually calculating a_n , we first note that

$$f(z) = \frac{1}{4z} \left(\frac{1}{1 - z/4} \right).$$

The second factor can be expanded in a geometric series because $|z/4| < 1$:

$$\frac{1}{1 - z/4} = \sum_{n=0}^{\infty} \left(\frac{z}{4} \right)^n = \sum_{n=0}^{\infty} 4^{-n} z^n.$$

¹²This is a reflection of the fact that the function is not analytic inside the entire circle $|z| = 1$; it blows up at $z = 0$.

Dividing this by $4z$, and noting that $z = 0$ is the only zero of $4z$ and is excluded from the annular region, we obtain the expansion

$$f(z) = \sum_{n=0}^{\infty} 4^{-n} \frac{z^n}{4z} = \sum_{n=0}^{\infty} 4^{-n-1} z^{n-1}.$$

Although we derived this series using manipulations of other series, the uniqueness of series representations assures us that this is *the* Laurent series for the indicated region.

How can we represent $f(z)$ in the region for which $|z| > 4$? This region is exterior to the circle $|z| = 4$, so we expect negative powers of z . To find the Laurent expansion we write

$$f(z) = -\frac{1}{z^2} \left(\frac{1}{1 - 4/z} \right)$$

and note that $|4/z| < 1$ for points exterior to the larger circle. The second factor can be written as a geometric series:

$$\frac{1}{1 - 4/z} = \sum_{n=0}^{\infty} \left(\frac{4}{z} \right)^n = \sum_{n=0}^{\infty} 4^n z^{-n}.$$

Dividing by $-z^2$, which is nonzero in the region exterior to the larger circle, yields

$$f(z) = -\sum_{n=0}^{\infty} 4^n z^{-n-2}.$$

Example 10.6.11 The function $f(z) = z/[(z-1)(z-2)]$ has a Taylor expansion around the origin for $|z| < 1$. To find this expansion, we write¹³

$$f(z) = -\frac{1}{z-1} + \frac{2}{z-2} = \frac{1}{1-z} - \frac{1}{1-z/2}.$$

Expanding both fractions in geometric series (both $|z|$ and $|z/2|$ are less than 1), we obtain $f(z) = \sum_{n=0}^{\infty} z^n - \sum_{n=0}^{\infty} (z/2)^n$. Adding the two series—using Theorem 10.6.8—yields

$$f(z) = \sum_{n=0}^{\infty} (1 - 2^{-n}) z^n \quad \text{for } |z| < 1.$$

This is the unique Taylor expansion of $f(z)$ within the circle $|z| = 1$.

For $1 < |z| < 2$ we have a Laurent series. To obtain this series, write

$$f(z) = \frac{1/z}{1/z-1} - \frac{1}{1-z/2} = -\frac{1}{z} \left(\frac{1}{1-1/z} \right) - \frac{1}{1-z/2}.$$

¹³We could, of course, evaluate the derivatives of all orders of the function at $z = 0$ and use Maclaurin's formula. However, the present method gives the same result much more quickly.

Since both fractions on the RHS converge in the annular region ($|1/z| < 1$, $|z/2| < 1$), we get

$$\begin{aligned} f(z) &= -\frac{1}{z} \sum_{n=0}^{\infty} \left(\frac{1}{z}\right)^n - \sum_{n=0}^{\infty} \left(\frac{z}{2}\right)^n = -\sum_{n=0}^{\infty} z^{-n-1} - \sum_{n=0}^{\infty} 2^{-n} z^n \\ &= -\sum_{n=-1}^{-\infty} z^n - \sum_{n=0}^{\infty} 2^{-n} z^n = \sum_{n=-\infty}^{\infty} a_n z^n, \end{aligned}$$

where $a_n = -1$ for $n < 0$ and $a_n = -2^{-n}$ for $n \geq 0$. This is the unique Laurent expansion of $f(z)$ in the given region.

Finally, for $|z| > 2$ we have only negative powers of z . We obtain the expansion in this region by rewriting $f(z)$ as follows:

$$f(z) = -\frac{1/z}{1 - 1/z} + \frac{2/z}{1 - 2/z}.$$

Expanding the fractions yields

$$f(z) = -\sum_{n=0}^{\infty} z^{-n-1} + \sum_{n=0}^{\infty} 2^{n+1} z^{-n-1} = \sum_{n=0}^{\infty} (2^{n+1} - 1) z^{-n-1}.$$

This is again the unique expansion of $f(z)$ in the region $|z| > 2$.

Example 10.6.12 Define $f(z)$ as

$$f(z) = \begin{cases} (1 - \cos z)/z^2 & \text{for } z \neq 0, \\ \frac{1}{2} & \text{for } z = 0. \end{cases}$$

We can show that $f(z)$ is an entire function.

Since $1 - \cos z$ and z^2 are entire functions, their ratio is analytic everywhere except at the zeros of its denominator. The only such zero is $z = 0$. Thus, Theorem 10.6.8 implies that $f(z)$ is analytic everywhere except possibly at $z = 0$. To see the behavior of $f(z)$ at $z = 0$, we look at its Maclaurin series:

$$1 - \cos z = 1 - \sum_{n=0}^{\infty} (-1)^n \frac{z^{2n}}{(2n)!},$$

which implies that

$$\frac{1 - \cos z}{z^2} = \sum_{n=1}^{\infty} (-1)^{n+1} \frac{z^{2n-2}}{(2n)!} = \frac{1}{2} - \frac{z^2}{4!} + \frac{z^4}{6!} - \dots.$$

The expansion on the RHS shows that the value of the series at $z = 0$ is $\frac{1}{2}$, which, by definition, is $f(0)$. Thus, the series converges for all z , and Theorem 10.6.2 says that $f(z)$ is entire.

A Laurent series can give information about the integral of a function around a closed contour in whose interior the function may not be analytic. In fact, the coefficient of the first negative power in a Laurent series is given

by

$$a_{-1} = \frac{1}{2\pi i} \oint_C f(\xi) d\xi. \quad (10.17)$$

Thus, to find the integral of a (nonanalytic) function around a closed contour surrounding z_0 , we write the Laurent series for the function and read off the coefficient of the $1/(z - z_0)$ term.

Example 10.6.13 As an illustration of this idea, let us evaluate the integral $I = \oint_C dz/[z^2(z - 2)]$, where C is the circle of radius 1 centered at the origin. The function is analytic in the annular region $0 < |z| < 2$. We can therefore expand it as a Laurent series about $z = 0$ in that region:

$$\begin{aligned} \frac{1}{z^2(z - 2)} &= -\frac{1}{2z^2} \left(\frac{1}{1 - z/2} \right) = -\frac{1}{2z^2} \sum_{n=0}^{\infty} \left(\frac{z}{2} \right)^n \\ &= -\frac{1}{2} \left(\frac{1}{z^2} \right) - \frac{1}{4} \left(\frac{1}{z} \right) - \frac{1}{8} - \cdots . \end{aligned}$$

Thus, $a_{-1} = -\frac{1}{4}$, and $\oint_C dz/[z^2(z - 2)] = 2\pi i a_{-1} = -i\pi/2$. A direct evaluation of the integral is nontrivial. In fact, we will see later that to find certain integrals, it is advantageous to cast them in the form of a contour integral and use either Eq. (10.17) or a related equation.

Let $f : \mathbb{C} \rightarrow \mathbb{C}$ be analytic at z_0 . Then by definition, there exists a *neighborhood* of z_0 in which f is analytic. In particular, we can find a circle $|z - z_0| = r > 0$ in whose interior f has a Taylor expansion.

Definition 10.6.14 Let

$$f(z) = \sum_{n=0}^{\infty} \frac{f^{(n)}(z_0)}{n!} (z - z_0)^n \equiv \sum_{n=0}^{\infty} a_n (z - z_0)^n.$$

Then f is said to have a **zero of order k** at z_0 if $f^{(n)}(z_0) = 0$ for $n = 0, 1, \dots, k - 1$ but $f^{(k)}(z_0) \neq 0$.

In that case $f(z) = (z - z_0)^k \sum_{n=0}^{\infty} a_{k+n} (z - z_0)^n$, where $a_k \neq 0$ and $|z - z_0| < r$. We define $g(z)$ as

$$g(z) = \sum_{n=0}^{\infty} a_{k+n} (z - z_0)^n \quad \text{where } |z - z_0| < r$$

and note that $g(z_0) = a_k \neq 0$. Convergence of the series on the RHS implies that $g(z)$ is continuous at z_0 . Consequently, for each $\epsilon > 0$, there exists δ such that $|g(z) - a_k| < \epsilon$ whenever $|z - z_0| < \delta$. If we choose $\epsilon = |a_k|/2$, then, for some $\delta_0 > 0$, $|g(z) - a_k| < |a_k|/2$ whenever $|z - z_0| < \delta_0$. Thus, as long as z is inside the circle $|z - z_0| < \delta_0$, $g(z)$ cannot vanish (because if it did the first inequality would imply that $|a_k| < |a_k|/2$). We therefore have the following result.

the zeros of an analytic function are isolated **Theorem 10.6.15** Let $f : \mathbb{C} \rightarrow \mathbb{C}$ be analytic at z_0 and $f(z_0) = 0$. Then there exists a neighborhood of z_0 throughout which f has no other zeros unless f is identically zero there. Thus, the zeros of an analytic function are *isolated*.

simple zero When $k = 1$, we say that z_0 is a **simple zero** of f . To find the order of the zero of a function at a point, we differentiate the function, evaluate the derivative at that point, and continue the process until we obtain a nonzero value for the derivative.

Example 10.6.16 Here are some functions with their zeros:

(a) The zeros of $\cos z$, which are $z = (2k + 1)\pi/2$, are all simple, because

$$\left. \frac{d}{dz} \cos z \right|_{z=(2k+1)\pi/2} = -\sin \left[(2k+1) \frac{\pi}{2} \right] \neq 0.$$

(b) To find the order of the zero of $f(z) = e^z - 1 - z - z^2/2$ at $z = 0$, we differentiate $f(z)$ and evaluate $f'(0)$:

$$f'(0) = (e^z - 1 - z)_{z=0} = 0.$$

Differentiating again gives $f''(0) = (e^z - 1)_{z=0} = 0$. Differentiating once more yields $f'''(0) = (e^z)_{z=0} = 1$. Thus, the zero is of order 3.

10.7 Problems

10.1 Show that the function $w = 1/z$ maps the straight line $y = a$ in the z -plane onto a circle in the w -plane with radius $1/(2|a|)$ and center $(0, 1/(2a))$.

10.2 Treating x and y as functions of z and z^* ,

- use the chain rule to find $\partial f/\partial z^*$ and $\partial f/\partial z$ in terms of partial derivatives with respect to x and y .
- Evaluate $\partial f/\partial z^*$ and $\partial f/\partial z$ assuming that the Cauchy-Riemann conditions hold.

10.3 Show that when z is represented by polar coordinates, the derivative of a function $f(z)$ can be written as

$$\frac{df}{dz} = e^{-i\theta} \left(\frac{\partial U}{\partial r} + i \frac{\partial V}{\partial r} \right),$$

where U and V are the real and imaginary parts of $f(z)$ written in polar coordinates. What are the C-R conditions in polar coordinates? Hint: Start with the C-R conditions in Cartesian coordinates and apply the chain rule to them using $r = \sqrt{x^2 + y^2}$ and $\theta = \tan^{-1}(y/x) = \cos^{-1}(x/\sqrt{x^2 + y^2})$.

10.4 Show that $\frac{d}{dz}(\ln z) = \frac{1}{z}$. Hint: Find $u(x, y)$ and $v(x, y)$ for $\ln z$ and differentiate them.

10.5 Show that $\sin z$ and $\cos z$ have only real roots.

10.6 Show that

- (a) the sum and the product of two entire functions are entire, and
- (b) the ratio of two entire functions is analytic everywhere except at the zeros of the denominator.

10.7 Given that $u = 2\lambda \ln[(x^2 + y^2)^{1/2}]$, show that $v = 2\lambda \tan^{-1}(y/x)$, where u and v are the real and imaginary parts of an analytic function $w(z)$.

10.8 If $w(z)$ is any complex potential, show that its (complex) derivative gives the components of the electric field.

10.9 Show that

- (a) the flux through an element of area da of the lateral surface of a cylinder (with arbitrary cross section) is $d\phi = dz(|\mathbf{E}| ds)$ where ds is an arc length along the equipotential surface.
- (b) Prove that $|\mathbf{E}| = |dw/dz| = \partial v/\partial s$ where v is the imaginary part of the complex potential, and s is the parameter describing the length along the equipotential curves.
- (c) Combine (a) and (b) to get

$$\text{flux per unit } z\text{-length} = \frac{\phi}{z_2 - z_1} = v(P_2) - v(P_1)$$

for any two points P_1 and P_2 on the cross-sectional curve of the lateral surface. Conclude that the total flux per unit z -length through a cylinder (with arbitrary cross section) is $[v]$, the total change in v as one goes around the curve.

- (d) Using Gauss's law, show that the capacitance per unit length for the capacitor consisting of the two conductors with potentials u_1 and u_2 is

$$c \equiv \frac{\text{charge per unit length}}{\text{potential difference}} = \frac{[v]/4\pi}{|u_2 - u_1|}.$$

10.10 Using Eq. (10.7)

- (a) find the equipotential curves (curves of constant u) and curves of constant v for two line charges of equal magnitude and opposite signs located at $y = a$ and $y = -a$ in the xy -plane.
- (b) Show that

$$z = a \left(\sin \frac{v}{2\lambda} + i \sinh \frac{u}{2\lambda} \right) / \left(\cosh \frac{u}{2\lambda} - \cos \frac{v}{2\lambda} \right)$$

by solving Eq. (10.7) for z and simplifying.

- (c) Show that the equipotential curves are circles in the xy -plane of radii $a/\sinh(u/2\lambda)$ with centers at $(0, a \coth(u/2\lambda))$, and that the curves of constant v are circles of radii $a/\sin(v/2\lambda)$ with centers at $(a \cot(v/2\lambda), 0)$.

10.11 In this problem, you will find the capacitance per unit length of two cylindrical conductors of radii R_1 and R_2 the distance between whose centers is D by looking for two line charge densities $+\lambda$ and $-\lambda$ such that the two cylinders are two of the equipotential surfaces. From Problem 10.10, we have

$$R_i = \frac{a}{\sinh(u_i/2\lambda)}, \quad y_i = a \coth(u_i/2\lambda), \quad i = 1, 2,$$

where y_1 and y_2 are the locations of the centers of the two conductors on the y -axis (which we assume to connect the two centers).

- (a) Show that $D = |y_1 - y_2| = |R_1 \cosh \frac{u_1}{2\lambda} - R_2 \cosh \frac{u_2}{2\lambda}|$.
 (b) Square both sides and use $\cosh(a - b) = \cosh a \cosh b - \sinh a \sinh b$ and the expressions for the R 's and the y 's given above to obtain

$$\cosh\left(\frac{u_1 - u_2}{2\lambda}\right) = \left| \frac{R_1^2 + R_2^2 - D^2}{2R_1 R_2} \right|.$$

- (c) Now find the capacitance per unit length. Consider the special case of two concentric cylinders.
 (d) Find the capacitance per unit length of a cylinder and a plane, by letting one of the radii, say R_1 , go to infinity while $h \equiv R_1 - D$ remains fixed.

10.12 Use Equations (10.4) and (10.5) to establish the following identities.

- (a) $\operatorname{Re}(\sin z) = \sin x \cosh y$, (b) $\operatorname{Im}(\sin z) = \cos x \sinh y$,
 (c) $\operatorname{Re}(\cos z) = \cos x \cosh y$, (d) $\operatorname{Im}(\cos z) = -\sin x \sinh y$,
 (e) $\operatorname{Re}(\sinh z) = \sinh x \cos y$, (f) $\operatorname{Im}(\sinh z) = \cosh x \sin y$,
 (g) $\operatorname{Re}(\cosh z) = \cosh x \cos y$, (h) $\operatorname{Im}(\cosh z) = \sinh x \sin y$,
 (i) $|\sin z|^2 = \sin^2 x + \sinh^2 y$, (j) $|\cos z|^2 = \cos^2 x + \sinh^2 y$,
 (k) $|\sinh z|^2 = \sinh^2 x + \sin^2 y$, (l) $|\cosh z|^2 = \sinh^2 x + \cos^2 y$.

10.13 Find all the zeros of $\sinh z$ and $\cosh z$.

10.14 Verify the following hyperbolic identities.

- (a) $\cosh^2 z - \sinh^2 z = 1$.
 (b) $\cosh(z_1 + z_2) = \cosh z_1 \cosh z_2 + \sinh z_1 \sinh z_2$.
 (c) $\sinh(z_1 + z_2) = \sinh z_1 \cosh z_2 + \cosh z_1 \sinh z_2$.
 (d) $\cosh 2z = \cosh^2 z + \sinh^2 z$, $\sinh 2z = 2 \sinh z \cosh z$.
 (e) $\tanh(z_1 + z_2) = \frac{\tanh z_1 + \tanh z_2}{1 + \tanh z_1 \tanh z_2}$.

10.15 Show that

$$(a) \quad \tanh\left(\frac{z}{2}\right) = \frac{\sinh x + i \sin y}{\cosh x + \cos y}, \quad (b) \quad \coth\left(\frac{z}{2}\right) = \frac{\sinh x - i \sin y}{\cosh x - \cos y}.$$

10.16 Find all values of z such that

$$(a) \quad e^z = -3, \quad (b) \quad e^z = 1 + i\sqrt{3}, \quad (c) \quad e^{2z-1} = 1.$$

10.17 Show that $|e^{-z}| < 1$ if and only if $\operatorname{Re}(z) > 0$.

10.18 Show that each of the following functions—call each one $u(x, y)$ —is harmonic, and find the function's harmonic partner, $v(x, y)$, such that $u(x, y) + iv(x, y)$ is analytic.

- (a) $x^3 - 3xy^2$; (b) $e^x \cos y$;
 (c) $\frac{x}{x^2 + y^2}$, where $x^2 + y^2 \neq 0$;
 (d) $e^{-2y} \cos 2x$; (e) $e^{y^2 - x^2} \cos 2xy$;
 (f) $e^x(x \cos y - y \sin y) + 2 \sinh y \sin x + x^3 - 3xy^2 + y$.

10.19 Prove the following identities.

- (a) $\cos^{-1} z = -i \ln(z \pm \sqrt{z^2 - 1})$,
 (b) $\sin^{-1} z = -i \ln[iz \pm \sqrt{1 - z^2}]$,
 (c) $\tan^{-1} z = \frac{1}{2i} \ln\left(\frac{i - z}{i + z}\right)$,
 (d) $\cosh^{-1} z = \ln(z \pm \sqrt{z^2 - 1})$,
 (e) $\sinh^{-1} z = \ln(z \pm \sqrt{z^2 + 1})$,
 (f) $\tanh^{-1} z = \frac{1}{2} \ln\left(\frac{1 + z}{1 - z}\right)$.

10.20 Find the curve defined by each of the following equations.

- (a) $z = 1 - it, \quad 0 \leq t \leq 2$,
 (b) $z = t + it^2, \quad -\infty < t < \infty$,
 (c) $z = a(\cos t + i \sin t), \quad \frac{\pi}{2} \leq t \leq \frac{3\pi}{2}$,
 (d) $z = t + \frac{i}{t}, \quad -\infty < t < 0$.

10.21 Prove part (a) of Proposition 10.3.1. Hint: A small displacement along γ_i can be written as $\hat{e}_x \Delta x_i + \hat{e}_y \Delta y_i$ for $i = 1, 2$. Find a unit vector along each displacement and take the dot product of the two. Do the same

for γ'_i ; use the C-R condition to show that the two are equal. Prove part (b) by showing that if $f(z) = z' = x' + iy'$ is analytic and $\frac{\partial^2 \phi}{\partial x^2} + \frac{\partial^2 \phi}{\partial y^2} = 0$, then $\frac{\partial^2 \phi}{\partial x^2} + \frac{\partial^2 \phi}{\partial y^2} = 0$.

10.22 Let $f(t) = u(t) + iv(t)$ be a (piecewise) continuous complex-valued function of a real variable t defined in the interval $a \leq t \leq b$. Show that if $F(t) = U(t) + iV(t)$ is a function such that $dF/dt = f(t)$, then

$$\int_a^b f(t) dt = F(b) - F(a).$$

This is the fundamental theorem of calculus for complex variables.

10.23 Find the value of the integral $\int_C [(z+2)/z] dz$, where C is

- the semicircle $z = 2e^{i\theta}$, for $0 \leq \theta \leq \pi$,
- the semicircle $z = 2e^{i\theta}$, for $\pi \leq \theta \leq 2\pi$, and
- the circle $z = 2e^{i\theta}$, for $-\pi \leq \theta \leq \pi$.

10.24 Evaluate the integral $\int_\gamma dz/(z-1-i)$ where γ is

- the line joining $z_1 = 2i$ and $z_2 = 3$, and
- the broken path from z_1 to the origin and from there to z_2 .

10.25 Evaluate the integral $\int_C z^m (z^*)^n dz$, where m and n are integers and C is the circle $|z| = 1$ taken counterclockwise.

10.26 Let C be the boundary of the square with vertices at the points $z = 0$, $z = 1$, $z = 1 + i$, and $z = i$ with counterclockwise direction. Evaluate

$$\oint_C (5z+2) dz \quad \text{and} \quad \oint_C e^{\pi z^*} dz.$$

10.27 Use the definition of an integral as the limit of a sum and the fact that absolute value of a sum is less than or equal to the sum of absolute values to prove the Darboux inequality.

10.28 Let C_1 be a simple closed contour. Deform C_1 into a new contour C_2 in such a way that C_1 does not encounter any singularity of an analytic function f in the process. Show that

$$\oint_{C_1} f(z) dz = \oint_{C_2} f(z) dz.$$

That is, the contour can always be deformed into simpler shapes (such as a circle) and the integral evaluated.

10.29 Use the result of the previous problem to show that

$$\oint_C \frac{dz}{z-1-i} = 2\pi i \quad \text{and} \quad \oint_C (z-1-i)^{m-1} dz = 0 \quad \text{for } m = \pm 1, \pm 2, \dots$$

when C is the boundary of a square with vertices at $z = 0$, $z = 2$, $z = 2 + 2i$, and $z = 2i$, taken counterclockwise.

10.30 Use Eq. (10.12) and the binomial expansion to show that $\frac{d}{dz}(z^m) = mz^{m-1}$.

10.31 Evaluate $\oint_C dz/(z^2 - 1)$ where C is the circle $|z| = 3$ integrated in the positive sense. Hint: Deform C into a contour C' that avoids the singularities of the integrand. Then use Cauchy Goursat theorem.

10.32 Show that when f is analytic within and on a simple closed contour C and z_0 is not on C , then

$$\oint_C \frac{f'(z) dz}{z - z_0} = \oint_C \frac{f(z) dz}{(z - z_0)^2}.$$

10.33 Let C be the boundary of a square whose sides lie along the lines $x = \pm 3$ and $y = \pm 3$. For the positive sense of integration, evaluate each of the following integrals.

- | | |
|--|---|
| (a) $\oint_C \frac{e^{-z} dz}{z - i\pi/2}$, | (b) $\oint_C \frac{e^z dz}{z(z^2 + 10)}$, |
| (c) $\oint_C \frac{\cos z dz}{(z - \frac{\pi}{4})(z^2 - 10)}$, | (d) $\oint_C \frac{\sinh z dz}{z^4}$, |
| (e) $\oint_C \frac{\cosh z dz}{z^4}$, | (f) $\oint_C \frac{\cos z dz}{z^3}$, |
| (g) $\oint_C \frac{\cos z dz}{(z - i\pi/2)^2}$, | (h) $\oint_C \frac{e^z dz}{(z - i\pi)^2}$, |
| (i) $\oint_C \frac{\cos z dz}{z + i\pi}$, | (j) $\oint_C \frac{e^z dz}{z^2 - 5z + 4}$, |
| (k) $\oint_C \frac{\sinh z dz}{(z - i\pi/2)^2}$, | (l) $\oint_C \frac{\cosh z dz}{(z - i\pi/2)^2}$, |
| (m) $\oint_C \frac{\tan z dz}{(z - \alpha)^2}$, for $-3 < \alpha < 3$, | (n) $\oint_C \frac{z^2 dz}{(z - 2)(z^2 - 10)}$. |

10.34 Let C be the circle $|z - i| = 3$ integrated in the positive sense. Find the value of each of the following integrals.

- | | |
|--|--|
| (a) $\oint_C \frac{e^z}{z^2 + \pi^2} dz$, | (b) $\oint_C \frac{\sinh z}{(z^2 + \pi^2)^2} dz$, |
| (c) $\oint_C \frac{dz}{z^2 + 9}$, | (d) $\oint_C \frac{dz}{(z^2 + 9)^2}$, |
| (e) $\oint_C \frac{\cosh z}{(z^2 + \pi^2)^3} dz$, | (f) $\oint_C \frac{z^2 - 3z + 4}{z^2 - 4z + 3} dz$. |

10.35 Show that Legendre polynomials (for $|x| < 1$) can be represented as

$$P_n(x) = \frac{(-1)^n}{2^n(2\pi i)} \oint_C \frac{(1-z^2)^n}{(z-x)^{n+1}} dz,$$

where C is the unit circle around the origin.

10.36 Let f be analytic within and on the circle γ_0 given by $|z - z_0| = r_0$ and integrated in the positive sense. Show that **Cauchy's inequality** holds:

$$|f^{(n)}(z_0)| \leq \frac{n!M}{r_0^n},$$

where M is the maximum value of $|f(z)|$ on γ_0 .

10.37 Expand $\sinh z$ in a Taylor series about the point $z = i\pi$.

10.38 What is the largest circle within which the Maclaurin series for $\tanh z$ converges to $\tanh z$?

10.39 Find the (unique) Laurent expansion of each of the following functions about the origin for its entire region of analyticity.

$$\begin{array}{lll} \text{(a)} \quad \frac{1}{(z-2)(z-3)}; & \text{(b)} \quad z \cos(z^2); & \text{(c)} \quad \frac{1}{z^2(1-z)}; \\ \text{(d)} \quad \frac{\sinh z - z}{z^4}; & \text{(e)} \quad \frac{1}{(1-z)^3}; & \text{(f)} \quad \frac{1}{z^2-1}; \\ \text{(g)} \quad \frac{z^2-4}{z^2-9}; & \text{(h)} \quad \frac{1}{(z^2-1)^2}; & \text{(i)} \quad \frac{z}{z-1}. \end{array}$$

10.40 Show that the following functions are entire.

$$\begin{array}{l} \text{(a)} \quad f(z) = \begin{cases} \frac{e^{2z}-1}{z^2} - \frac{2}{z} & \text{for } z \neq 0, \\ 2 & \text{for } z = 0. \end{cases} \\ \text{(b)} \quad f(z) = \begin{cases} \frac{\sin z}{z} & \text{for } z \neq 0, \\ 1 & \text{for } z = 0. \end{cases} \\ \text{(c)} \quad f(z) = \begin{cases} \frac{\cos z}{z^2-\pi^2/4} & \text{for } z \neq \pm\pi/2, \\ -1/\pi & \text{for } z = \pm\pi/2. \end{cases} \end{array}$$

10.41 Let f be analytic at z_0 and $f(z_0) = f'(z_0) = \dots = f^{(k)}(z_0) = 0$. Show that the following function is analytic at z_0 :

$$g(z) = \begin{cases} \frac{f(z)}{(z-z_0)^{k+1}} & \text{for } z \neq z_0, \\ \frac{f^{(k+1)}(z_0)}{(k+1)!} & \text{for } z = z_0. \end{cases}$$

10.42 Obtain the first few nonzero terms of the Laurent series expansion of each of the following functions about the origin. Also find the integral of the function along a small simple closed contour encircling the origin.

- (a) $\frac{1}{\sin z}$; (b) $\frac{1}{1 - \cos z}$; (c) $\frac{z}{1 - \cosh z}$;
(d) $\frac{z^2}{z - \sin z}$; (e) $\frac{z^4}{6z + z^3 - 6 \sinh z}$; (f) $\frac{1}{z^2 \sin z}$;
(g) $\frac{1}{e^z - 1}$.

One of the most powerful tools made available by complex analysis is the theory of residues, which makes possible the routine evaluation of certain definite integrals that are impossible to calculate otherwise. The derivation, application, and analysis of this tool constitute the main focus of this chapter. In the preceding chapter we saw examples in which integrals were related to expansion coefficients of Laurent series. Here we will develop a systematic way of evaluating both real and complex integrals.

11.1 Residues

Recall that a singular point z_0 of $f : \mathbb{C} \rightarrow \mathbb{C}$ is a point at which f fails to be analytic. If in addition, there is some neighborhood of z_0 in which f is analytic at every point (except of course at z_0 itself), then z_0 is called an **isolated singularity** of f . Almost all the singularities we have encountered so far have been isolated singularities. However, we will see later—when discussing multivalued functions—that singularities that are not isolated do exist.

isolated singularity

Let z_0 be an isolated singularity of f . Then there exists an $r > 0$ such that within the “annular” region $0 < |z - z_0| < r$, the function f has the Laurent expansion

$$f(z) = \sum_{n=-\infty}^{\infty} a_n(z - z_0)^n \equiv \sum_{n=0}^{\infty} a_n(z - z_0)^n + \frac{b_1}{z - z_0} + \frac{b_2}{(z - z_0)^2} + \dots$$

where

$$a_n = \frac{1}{2\pi i} \oint_C \frac{f(\xi) d\xi}{(\xi - z_0)^{n+1}} \quad \text{and} \quad b_n = \frac{1}{2\pi i} \oint_C f(\xi)(\xi - z_0)^{n-1} d\xi.$$

In particular,

$$b_1 = \frac{1}{2\pi i} \oint_C f(\xi) d\xi, \tag{11.1}$$

where C is any simple closed contour around z_0 , traversed in the positive sense, on and interior to which f is analytic except at the point z_0 itself. The complex number b_1 , which is essentially the integral of $f(z)$ along the

residue defined contour, is called the **residue** of f at the isolated singular point z_0 . It is important to note that the residue is independent of the contour C as long as z_0 is the only isolated singular point within C .

Historical Notes

Pierre Alphonse Laurent (1813–1854) graduated from the Ecole Polytechnique near the top of his class and became a second lieutenant in the engineering corps. On his return from the war in Algeria, he took part in the effort to improve the port at Le Havre, spending six years there directing various parts of the project. Laurent's superior officers admired the breadth of his practical experience and the good judgment it afforded the young engineer. During this period he wrote his first scientific paper, on the calculus of variations, and submitted it to the French Academy of Sciences for the grand prix in mathematics. Unfortunately the competition had already closed (although the judges had not yet declared a winner), and Laurent's submission was not successful. However, the paper so impressed Cauchy that he recommended its publication, also without success. The paper for which Laurent is most well known suffered a similar fate. In it he described a more general form of a theorem earlier proven by Cauchy for the power series expansion of a function. Laurent realized that one could generalize this result to hold in any annular region between two singular or discontinuous points by using both positive and negative powers in the series, thus allowing treatment of regions beyond the first singular or discontinuous point. Again, Cauchy argued for the paper's publication without success. The passage of time provided a more just reward, however, and the use of Laurent series became a fundamental tool in complex analysis.

Laurent later worked in the theory of light waves and contended with Cauchy over the interpretation of the differential equations the latter had formulated to explain the behavior of light. Little came of his work in this area, however, and Laurent died at the age of forty-two, a captain serving on the committee on fortifications in Paris. His widow pressed to have two more of his papers read to the Academy, only one of which was published.

We use the notation $\text{Res}[f(z_0)]$ to denote the residue of f at the isolated singular point z_0 . Equation (11.1) can then be written as

$$\oint_C f(z) dz = 2\pi i \text{Res}[f(z_0)].$$

What if there are several isolated singular points within the simple closed contour C ? The following theorem provides the answer.

residue theorem

Theorem 11.1.1 (The residue theorem) *Let C be a positively oriented simple closed contour within and on which a function f is analytic except at a finite number of isolated singular points z_1, z_2, \dots, z_m interior to C . Then*

$$\oint_C f(z) dz = 2\pi i \sum_{k=1}^m \text{Res}[f(z_k)]. \quad (11.2)$$

Proof Let C_k be the positively traversed circle around z_k . Then Fig. 11.1 and the Cauchy-Goursat theorem yield

$$0 = \oint_{C'} f(z) dz = - \oint_{\text{circles}} f(z) dz + \oint_{\text{lines}} f(z) dz + \oint_C f(z) dz,$$

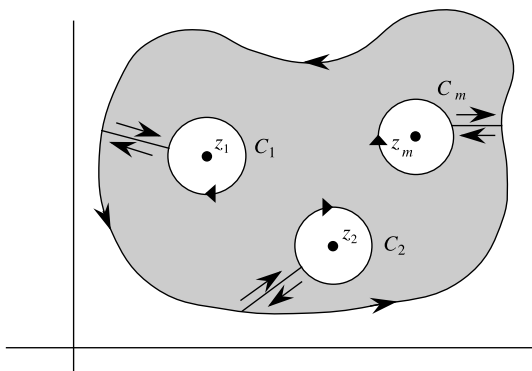

Fig. 11.1 Singularities are avoided by going around them

where C' is the union of all the contours, and the minus sign on the first integral is due to the fact that the interiors of all circles lie to our right as we traverse their boundaries. The two equal an opposite contributions of each line cancel out, and we obtain

$$\oint_C f(z) dz = \sum_{k=1}^m \oint_{C_k} f(z) dz = \sum_{k=1}^m 2\pi i \operatorname{Res}[f(z_k)],$$

where in the last step the definition of residue at z_k has been used. □

Example 11.1.2 Let us evaluate the integral $\oint_C (2z - 3) dz / [z(z - 1)]$ where C is the circle $|z| = 2$. There are two isolated singularities in C , $z_1 = 0$ and $z_2 = 1$. To find $\operatorname{Res}[f(z_1)]$, we expand around the origin:

$$\frac{2z - 3}{z(z - 1)} = \frac{3}{z} - \frac{1}{z - 1} = \frac{3}{z} + \frac{1}{1 - z} = \frac{3}{z} + 1 + z + \dots \quad \text{for } |z| < 1.$$

This gives $\operatorname{Res}[f(z_1)] = 3$. Similarly, expanding around $z = 1$ gives

$$\frac{2z - 3}{z(z - 1)} = \frac{3}{z - 1 + 1} - \frac{1}{z - 1} = -\frac{1}{z - 1} + 3 \sum_{k=0}^{\infty} (-1)^k (z - 1)^k,$$

which yields $\operatorname{Res}[f(z_2)] = -1$. Thus,

$$\oint_C \frac{2z - 3}{z(z - 1)} dz = 2\pi i \{ \operatorname{Res}[f(z_1)] + \operatorname{Res}[f(z_2)] \} = 2\pi i (3 - 1) = 4\pi i.$$

11.2 Classification of Isolated Singularities

Let $f : \mathbb{C} \rightarrow \mathbb{C}$ have an isolated singularity at z_0 . Then there exist a real number $r > 0$ and an annular region $0 < |z - z_0| < r$ such that f can be represented by the Laurent series

$$f(z) = \sum_{n=0}^{\infty} a_n(z - z_0)^n + \sum_{n=1}^{\infty} \frac{b_n}{(z - z_0)^n}. \tag{11.3}$$

The second sum in Eq. (11.3), involving negative powers of $(z - z_0)$, is called the **principal part** of f at z_0 . We can use the principal part to distinguish three types of isolated singularities. The behavior of the function near the isolated singularity is fundamentally different in each case.

removable singular point

1. If $b_n = 0$ for all $n \geq 1$, z_0 is called a **removable singular point** of f . In this case, the Laurent series contains only nonnegative powers of $(z - z_0)$, and setting $f(z_0) = a_0$ makes the function analytic at z_0 . For example, the function $f(z) = (e^z - 1 - z)/z^2$, which is indeterminate at $z = 0$, becomes entire if we set $f(0) = \frac{1}{2}$, because its Laurent series $f(z) = \frac{1}{2} + \frac{z}{3!} + \frac{z^2}{4!} + \dots$ has no negative power.

poles defined

2. If $b_n = 0$ for all $n > m$ and $b_m \neq 0$, z_0 is called a **pole of order m** . In this case, the expansion takes the form

$$f(z) = \sum_{n=0}^{\infty} a_n(z - z_0)^n + \frac{b_1}{z - z_0} + \dots + \frac{b_m}{(z - z_0)^m}$$

simple pole

3. If the principal part of f at z_0 has an infinite number of nonzero terms, the point z_0 is called an **essential singularity**. A prototype of functions that have essential singularities is

essential singularity

$$\exp\left(\frac{1}{z}\right) = \sum_{n=0}^{\infty} \frac{1}{n!} \left(\frac{1}{z^n}\right),$$

strange behavior of functions with essential singularity

which has an essential singularity at $z = 0$ and a residue of 1 there. To see how strange such functions are, we let a be any real number, and consider $z = 1/(\ln a + 2n\pi i)$ for $n = 0, \pm 1, \pm 2, \dots$. For such a z we have $e^{1/z} = e^{\ln a + 2n\pi i} = ae^{2n\pi i} = a$. In particular, as $n \rightarrow \infty$, z gets arbitrarily close to the origin. Thus, in an arbitrarily small neighborhood of the origin, there are infinitely many points at which the function $\exp(1/z)$ takes on an arbitrary value a . In other words, as $z \rightarrow 0$, the function gets arbitrarily close to any real number! This result holds for all functions with essential singularities.

Example 11.2.1 (Order of poles)

- (a) The function $(z^2 - 3z + 5)/(z - 1)$ has a Laurent series around $z = 1$ containing only three terms:

$$\frac{z^2 - 3z + 5}{z - 1} = -1 + (z - 1) + \frac{3}{z - 1}.$$

Thus, it has a simple pole at $z = 1$, with a residue of 3.

- (b) The function $\sin z/z^6$ has a Laurent series

$$\frac{\sin z}{z^6} = \frac{1}{z^6} \sum_{n=0}^{\infty} (-1)^n \frac{z^{2n+1}}{(2n+1)!} = \frac{1}{z^5} - \frac{1}{6z^3} + \frac{1}{(5!)z} - \frac{z}{7!} + \cdots$$

about $z = 0$. The principal part has three terms. The pole, at $z = 0$, is of order 5, and the function has a residue of $1/120$ at $z = 0$.

- (c) The function $(z^2 - 5z + 6)/(z - 2)$ has a removable singularity at $z = 2$, because

$$\frac{z^2 - 5z + 6}{z - 2} = \frac{(z - 2)(z - 3)}{z - 2} = z - 3 = -1 + (z - 2)$$

and $b_n = 0$ for all n .

Many functions can be written as the ratio of two polynomials. A function of this form is called a **rational function**. If the degree of the numerator is larger than the denominator, the ratio can be written as a polynomial plus a rational function the degree of whose numerator is not larger than that of the denominator. When we talk about rational functions, we exclude the polynomials. So, we assume that the degree of the numerator is less than or equal to the degree of the denominator. Such rational functions f have the property that as z goes to infinity, f does not go to infinity. Stated equivalently, $f(1/z)$ does not go to infinity at the origin.

Let f be a function whose only singularities in the entire complex plane are *finite poles*, i.e., the point at infinity is not a pole of the function. This means that $f(1/z)$ does not have a pole at the origin. Let $\{z_j\}_{j=1}^n$ be the poles of f such that z_j is of order m_j . Expand the function about z_1 in a Laurent series

$$f(z) = \frac{b_1}{z - z_1} + \cdots + \frac{b_{m_1}}{(z - z_1)^{m_1}} + \sum_{k=0}^{\infty} a_k (z - z_1)^k \equiv \frac{P_1(z)}{(z - z_1)^{m_1}} + g_1(z),$$

where

$$P_1(z) \equiv b_1(z - z_1)^{m_1-1} + b_2(z - z_1)^{m_1-2} + \cdots + b_{m_1-1}(z - z_1) + b_{m_1}$$

is a polynomial of degree $m_1 - 1$ in z and g_1 is analytic at z_1 . It should be clear that the remaining poles of f are in g_1 . So, expand g_1 about z_2 in a Laurent series. A similar argument as above yields $g_1(z) = P_2(z)/(z - z_2)^{m_2} + g_2(z)$ where $P_2(z)$ is a polynomial of degree $m_2 - 1$ in z and g_2 is analytic at z_1 and z_2 . Continuing in this manner, we get

$$f(z) = \frac{P_1(z)}{(z - z_1)^{m_1}} + \frac{P_2(z)}{(z - z_2)^{m_2}} + \cdots + \frac{P_n(z)}{(z - z_n)^{m_n}} + g(z),$$

where g has no poles. Since all poles of f have been isolated in the sum, g must be analytic everywhere in \mathbb{C} , i.e., an entire function. Now substitute $1/t$ for z , take the limit $t \rightarrow 0$, and note that, since the degree of P_i is

$m_i - 1$, all the terms in the preceding equation go to zero except possibly $g(1/t)$. Moreover,

$$\lim_{t \rightarrow 0} g(1/t) \neq \infty,$$

because, by assumption, the point at infinity is not a pole of f . Thus, g is a bounded entire function. By Proposition 10.5.5, g must be a constant. Taking a common denominator for all the terms yields a ratio of two polynomials. We have proved the following:

Proposition 11.2.2 *A function whose only singularities are poles in a finite region of the complex plane is a rational function.*

The isolated singularity that is most important in applications is a pole. For a function that has a pole of order m at z_0 , the calculation of residues is routine. Such a calculation, in turn, enables us to evaluate many integrals effortlessly. How do we calculate the residue of a function f having a pole of order m at z_0 ?

It is clear that if f has a pole of order m , then $g : \mathbb{C} \rightarrow \mathbb{C}$ defined by $g(z) \equiv (z - z_0)^m f(z)$ is analytic at z_0 . Thus, for any simple closed contour C that contains z_0 but no other singular point of f , we have

$$\text{Res}[f(z_0)] = \frac{1}{2\pi i} \oint_C f(z) dz = \frac{1}{2\pi i} \oint_C \frac{g(z) dz}{(z - z_0)^m} = \frac{g^{(m-1)}(z_0)}{(m-1)!}.$$

In terms of f this yields¹

Theorem 11.2.3 *If $f(z)$ has a pole of order m at z_0 , then*

$$\text{Res}[f(z_0)] = \frac{1}{(m-1)!} \lim_{z \rightarrow z_0} \frac{d^{m-1}}{dz^{m-1}} [(z - z_0)^m f(z)]. \quad (11.4)$$

For the special, but important, case of a simple pole, we obtain

$$\text{Res}[f(z_0)] = \lim_{z \rightarrow z_0} [(z - z_0) f(z)]. \quad (11.5)$$

11.3 Evaluation of Definite Integrals

The most widespread application of residues occurs in the evaluation of real definite integrals. It is possible to “complexify” certain real definite integrals and relate them to contour integrations in the complex plane. We will discuss this method shortly; however, we first need a lemma.

¹The limit is taken because in many cases the mere substitution of z_0 may result in an indeterminate form.

Lemma 11.3.1 (Jordan's lemma) *Let C_R be a semicircle of radius R in the upper half of the complex plane (UHP) and centered at the origin. Let f be a function that tends uniformly to zero faster than $1/|z|$ for $\arg(z) \in [0, \pi]$ as $|z| \rightarrow \infty$. Let α be a nonnegative real number. Then* Jordan's lemma

$$\lim_{R \rightarrow \infty} I_R \equiv \lim_{R \rightarrow \infty} \int_{C_R} e^{i\alpha z} f(z) dz = 0.$$

Proof For $z \in C_R$ we write $z = Re^{i\theta}$, $dz = iRe^{i\theta} d\theta$, and

$$i\alpha z = i\alpha(R \cos \theta + iR \sin \theta) = i\alpha R \cos \theta - \alpha R \sin \theta$$

and substitute in the absolute value of the integral to show that

$$|I_R| \leq \int_0^\pi e^{-\alpha R \sin \theta} R |f(Re^{i\theta})| d\theta.$$

By assumption, $R|f(Re^{i\theta})| < \epsilon(R)$ independent of θ , where $\epsilon(R)$ is an arbitrary positive number that tends to zero as $R \rightarrow \infty$. By breaking up the interval of integration into two equal pieces and changing θ to $\pi - \theta$ in the second integral, one can show that

$$|I_R| < 2\epsilon(R) \int_0^{\pi/2} e^{-\alpha R \sin \theta} d\theta.$$

Furthermore, by plotting $\sin \theta$ and $2\theta/\pi$ on the same graph, one can easily see that $\sin \theta \geq 2\theta/\pi$ for $0 \leq \theta \leq \pi/2$. Thus,

$$|I_R| < 2\epsilon(R) \int_0^{\pi/2} e^{-(2\alpha R/\pi)\theta} d\theta = \frac{\pi\epsilon(R)}{\alpha R} (1 - e^{-\alpha R}),$$

which goes to zero as R gets larger and larger. □

Note that Jordan's lemma applies for $\alpha = 0$ as well, because $(1 - e^{-\alpha R}) \rightarrow \alpha R$ as $\alpha \rightarrow 0$. If $\alpha < 0$, the lemma is still valid if the semicircle C_R is taken in the lower half of the complex plane (LHP) and $f(z)$ goes to zero uniformly for $\pi \leq \arg(z) \leq 2\pi$.

We are now in a position to apply the residue theorem to the evaluation of definite integrals. The three types of integrals most commonly encountered are discussed separately below. In all cases we assume that Jordan's lemma holds.

11.3.1 Integrals of Rational Functions

The first type of integral we can evaluate using the residue theorem is of the form

$$I_1 = \int_{-\infty}^{\infty} \frac{p(x)}{q(x)} dx,$$

where $p(x)$ and $q(x)$ are real polynomials, and $q(x) \neq 0$ for any real x . We can then write

$$I_1 = \lim_{R \rightarrow \infty} \int_{-R}^R \frac{p(x)}{q(x)} dx = \lim_{R \rightarrow \infty} \int_{C_x} \frac{p(z)}{q(z)} dz,$$

where C_x is the (open) contour lying on the real axis from $-R$ to $+R$. Since Jordan's lemma holds by assumption, we can close that contour by adding to it the semicircle of radius R [see Fig. 11.2(a)]. This will not affect the value of the integral, because in the limit $R \rightarrow \infty$, the contribution of the integral of the semicircle tends to zero. We close the contour in the UHP if $q(z)$ has at least one zero there. We then get

$$I_1 = \lim_{R \rightarrow \infty} \oint_C \frac{p(z)}{q(z)} dz = 2\pi i \sum_{j=1}^k \operatorname{Res} \left[\frac{p(z_j)}{q(z_j)} \right],$$

where C is the closed contour composed of the interval $(-R, R)$ and the semicircle C_R , and $\{z_j\}_{j=1}^k$ are the zeros of $q(z)$ in the UHP. We may instead close the contour in the LHP,² in which case

$$I_1 = -2\pi i \sum_{j=1}^k \operatorname{Res} \left[\frac{p(z_j)}{q(z_j)} \right],$$

where $\{z_j\}_{j=1}^k$ are the zeros of $q(z)$ in the LHP. The minus sign indicates that in the LHP we (are forced to) integrate clockwise.

Example 11.3.2 Let us evaluate the integral $I = \int_0^\infty x^2 dx / [(x^2 + 1)(x^2 + 9)]$. Since the integrand is even, we can extend the interval of integration to all real numbers (and divide the result by 2). It is shown below that Jordan's lemma holds. Therefore, we write the contour integral corresponding to I :

$$I = \frac{1}{2} \oint_C \frac{z^2 dz}{(z^2 + 1)(z^2 + 9)},$$

where C is as shown in Fig. 11.2(a). Note that the contour is traversed in the positive sense. This is always true for the UHP. The singularities of the function in the UHP are the *simple* poles i and $3i$ corresponding to the simple zeros of the denominator. The residues at these poles are

$$\begin{aligned} \operatorname{Res}[f(i)] &= \lim_{z \rightarrow i} (z - i) \frac{z^2}{(z - i)(z + i)(z^2 + 9)} = -\frac{1}{16i}, \\ \operatorname{Res}[f(3i)] &= \lim_{z \rightarrow 3i} (z - 3i) \frac{z^2}{(z^2 + 1)(z - 3i)(z + 3i)} = \frac{3}{16i}. \end{aligned}$$

²Provided that Jordan's lemma holds there.

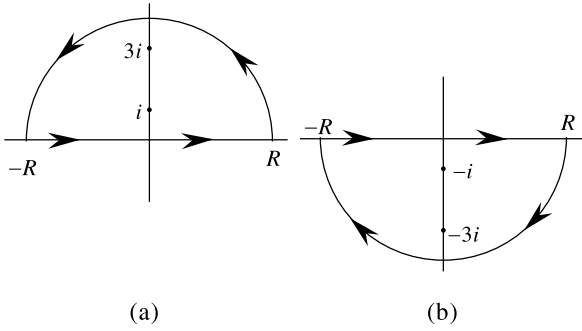

Fig. 11.2 (a) The large semicircle is chosen in the UHP. (b) Note how the direction of contour integration is forced to be clockwise when the semicircle is chosen in the LHP

Thus, we obtain

$$\begin{aligned} I &= \int_0^{\infty} \frac{x^2 dx}{(x^2 + 1)(x^2 + 9)} = \frac{1}{2} \oint_C \frac{z^2 dz}{(z^2 + 1)(z^2 + 9)} \\ &= \pi i \left(-\frac{1}{16i} + \frac{3}{16i} \right) = \frac{\pi}{8}. \end{aligned}$$

It is instructive to obtain the same results using the LHP. In this case, the contour is as shown in Fig. 11.2(b) and is taken clockwise, so we have to introduce a minus sign. The singular points are at $z = -i$ and $z = -3i$. These are simple poles at which the residues of the function are

$$\begin{aligned} \text{Res}[f(-i)] &= \lim_{z \rightarrow -i} (z + i) \frac{z^2}{(z - i)(z + i)(z^2 + 9)} = \frac{1}{16i}, \\ \text{Res}[f(-3i)] &= \lim_{z \rightarrow -3i} (z + 3i) \frac{z^2}{(z^2 + 1)(z - 3i)(z + 3i)} = -\frac{3}{16i}. \end{aligned}$$

Therefore,

$$\begin{aligned} I &= \int_0^{\infty} \frac{x^2 dx}{(x^2 + 1)(x^2 + 9)} = \frac{1}{2} \oint_C \frac{z^2 dz}{(z^2 + 1)(z^2 + 9)} \\ &= -\pi i \left(\frac{1}{16i} - \frac{3}{16i} \right) = \frac{\pi}{8}. \end{aligned}$$

To show that Jordan's lemma applies to this integral, we have only to establish that $\lim_{R \rightarrow \infty} R|f(Re^{i\theta})| = 0$. In the case at hand, $\alpha = 0$ because there is no exponential function in the integrand. Thus,

$$R|f(Re^{i\theta})| = R \left| \frac{R^2 e^{2i\theta}}{(R^2 e^{2i\theta} + 1)(R^2 e^{2i\theta} + 9)} \right| = \frac{R^3}{|R^2 e^{2i\theta} + 1| |R^2 e^{2i\theta} + 9|},$$

which clearly goes to zero as $R \rightarrow \infty$.

Example 11.3.3 Let us now consider a slightly more complicated integral:

$$\int_{-\infty}^{\infty} \frac{x^2 dx}{(x^2 + 1)(x^2 + 4)^2},$$

which turns into $\oint_C z^2 dz / [(z^2 + 1)(z^2 + 4)^2]$ as a contour integral. The poles in the UHP are at $z = i$ and $z = 2i$. The former is a simple pole, and the latter is a pole of order 2. Thus, using Eqs. (11.5) and (11.4), we obtain

$$\begin{aligned}\operatorname{Res}[f(i)] &= \lim_{z \rightarrow i} (z - i) \frac{z^2}{(z - i)(z + i)(z^2 + 4)^2} = -\frac{1}{18i}, \\ \operatorname{Res}[f(2i)] &= \frac{1}{(2 - 1)!} \lim_{z \rightarrow 2i} \frac{d}{dz} \left[(z - 2i)^2 \frac{z^2}{(z^2 + 1)(z + 2i)^2(z - 2i)^2} \right] \\ &= \lim_{z \rightarrow 2i} \frac{d}{dz} \left[\frac{z^2}{(z^2 + 1)(z + 2i)^2} \right] = \frac{5}{72i},\end{aligned}$$

and

$$\int_{-\infty}^{\infty} \frac{x^2 dx}{(x^2 + 1)(x^2 + 4)^2} = 2\pi i \left(-\frac{1}{18i} + \frac{5}{72i} \right) = \frac{\pi}{36}.$$

Closing the contour in the LHP would yield the same result.

11.3.2 Products of Rational and Trigonometric Functions

The second type of integral we can evaluate using the residue theorem is of the form

$$\int_{-\infty}^{\infty} \frac{p(x)}{q(x)} \cos ax \, dx \quad \text{or} \quad \int_{-\infty}^{\infty} \frac{p(x)}{q(x)} \sin ax \, dx,$$

where a is a real number, $p(x)$ and $q(x)$ are real polynomials in x , and $q(x)$ has no real zeros. These integrals are the real and imaginary parts of

$$I_2 = \int_{-\infty}^{\infty} \frac{p(x)}{q(x)} e^{iax} \, dx.$$

The presence of e^{iax} dictates the choice of the half-plane: If $a \geq 0$, we choose the UHP; otherwise, we choose the LHP. We must, of course, have enough powers of x in the denominator to render $R|p(Re^{i\theta})/q(Re^{i\theta})|$ uniformly convergent to zero.

Example 11.3.4 Let us evaluate $\int_{-\infty}^{\infty} [\cos ax / (x^2 + 1)^2] dx$ where $a \neq 0$. This integral is the real part of the integral $I_2 = \int_{-\infty}^{\infty} e^{iax} dx / (x^2 + 1)^2$. When $a > 0$, we close in the UHP as advised by Jordan's lemma. Then we proceed as for integrals of rational functions. Thus, we have

$$I_2 = \oint_C \frac{e^{iaz}}{(z^2 + 1)^2} dz = 2\pi i \operatorname{Res}[f(i)] \quad \text{for } a > 0$$

because there is only one pole (of order 2) in the UHP at $z = i$. We next calculate the residue:

$$\operatorname{Res}[f(i)] = \lim_{z \rightarrow i} \frac{d}{dz} \left[(z - i)^2 \frac{e^{iaz}}{(z - i)^2(z + i)^2} \right]$$

$$\begin{aligned}
&= \lim_{z \rightarrow i} \frac{d}{dz} \left[\frac{e^{iaz}}{(z+i)^2} \right] = \lim_{z \rightarrow i} \left[\frac{(z+i)iae^{iaz} - 2e^{iaz}}{(z+i)^3} \right] \\
&= \frac{e^{-a}}{4i} (1+a).
\end{aligned}$$

Substituting this in the expression for I_2 , we obtain $I_2 = \frac{\pi}{2} e^{-a} (1+a)$ for $a > 0$.

When $a < 0$, we have to close the contour in the LHP, where the pole of order 2 is at $z = -i$ and the contour is taken clockwise. Thus, we get

$$I_2 = \oint_C \frac{e^{iaz}}{(z^2+1)^2} dz = -2\pi i \operatorname{Res}[f(-i)] \quad \text{for } a < 0.$$

For the residue we obtain

$$\operatorname{Res}[f(-i)] = \lim_{z \rightarrow -i} \frac{d}{dz} \left[(z+i)^2 \frac{e^{iaz}}{(z-i)^2(z+i)^2} \right] = -\frac{e^a}{4i} (1-a),$$

and the expression for I_2 becomes $I_2 = \frac{\pi}{2} e^a (1-a)$ for $a < 0$. We can combine the two results and write

$$\int_{-\infty}^{\infty} \frac{\cos ax}{(x^2+1)^2} dx = \operatorname{Re}(I_2) = I_2 = \frac{\pi}{2} (1+|a|) e^{-|a|}.$$

Example 11.3.5 As another example, let us evaluate

$$\int_{-\infty}^{\infty} \frac{x \sin ax}{x^4+4} dx \quad \text{where } a \neq 0.$$

This is the imaginary part of the integral $I_2 = \int_{-\infty}^{\infty} x e^{iax} dx / (x^4+4)$, which, in terms of z and for the closed contour in the UHP (when $a > 0$), becomes

$$I_2 = \oint_C \frac{z e^{iaz}}{z^4+4} dz = 2\pi i \sum_{j=1}^m \operatorname{Res}[f(z_j)] \quad \text{for } a > 0. \quad (11.6)$$

The singularities are determined by the zeros of the denominator: $z^4+4=0$, or $z = 1 \pm i, -1 \pm i$. Of these four simple poles only two, $1+i$ and $-1+i$, are in the UHP. We now calculate the residues:

$$\begin{aligned}
&\operatorname{Res}[f(1+i)] \\
&= \lim_{z \rightarrow 1+i} (z-1-i) \frac{z e^{iaz}}{(z-1-i)(z-1+i)(z+1-i)(z+1+i)} \\
&= \frac{(1+i)e^{ia(1+i)}}{(2i)(2)(2+2i)} = \frac{e^{ia} e^{-a}}{8i},
\end{aligned}$$

$$\begin{aligned}
 & \text{Res}[f(-1+i)] \\
 &= \lim_{z \rightarrow -1+i} (z+1-i) \frac{ze^{iaz}}{(z+1-i)(z+1+i)(z-1-i)(z-1+i)} \\
 &= \frac{(-1+i)e^{ia(-1+i)}}{(2i)(-2)(-2+2i)} = -\frac{e^{-ia}e^{-a}}{8i}.
 \end{aligned}$$

Substituting in Eq. (11.6), we obtain

$$I_2 = 2\pi i \frac{e^{-a}}{8i} (e^{ia} - e^{-ia}) = i \frac{\pi}{2} e^{-a} \sin a.$$

Thus,

$$\int_{-\infty}^{\infty} \frac{x \sin ax}{x^4 + 4} dx = \text{Im}(I_2) = \frac{\pi}{2} e^{-a} \sin a \quad \text{for } a > 0. \quad (11.7)$$

For $a < 0$, we could close the contour in the LHP. But there is an easier way of getting to the answer. We note that $-a > 0$, and Eq. (11.7) yields

$$\begin{aligned}
 \int_{-\infty}^{\infty} \frac{x \sin ax}{x^4 + 4} dx &= - \int_{-\infty}^{\infty} \frac{x \sin[(-a)x]}{x^4 + 4} dx \\
 &= -\frac{\pi}{2} e^{-(-a)} \sin(-a) = \frac{\pi}{2} e^a \sin a.
 \end{aligned}$$

We can collect the two cases in

$$\int_{-\infty}^{\infty} \frac{x \sin ax}{x^4 + 4} dx = \frac{\pi}{2} e^{-|a|} \sin a.$$

11.3.3 Functions of Trigonometric Functions

The third type of integral we can evaluate using the residue theorem involves only trigonometric functions and is of the form

$$\int_0^{2\pi} F(\sin \theta, \cos \theta) d\theta,$$

where F is some (typically rational) function of its arguments. Since θ varies from 0 to 2π , we can consider it an argument of a point z on the unit circle centered at the origin. Then $z = e^{i\theta}$ and $e^{-i\theta} = 1/z$, and we can substitute $\cos \theta = (z + 1/z)/2$, $\sin \theta = (z - 1/z)/(2i)$, and $d\theta = dz/(iz)$ in the original integral, to obtain

$$\oint_C F\left(\frac{z-1/z}{2i}, \frac{z+1/z}{2}\right) \frac{dz}{iz}.$$

This integral can often be evaluated using the method of residues.

Example 11.3.6 Let us evaluate the integral $\int_0^{2\pi} d\theta/(1 + a \cos \theta)$ where $|a| < 1$. Substituting for $\cos \theta$ and $d\theta$ in terms of z , we obtain

$$\oint_C \frac{dz/iz}{1 + a[(z^2 + 1)/(2z)]} = \frac{2}{i} \oint_C \frac{dz}{2z + az^2 + a},$$

where C is the unit circle centered at the origin. The singularities of the integrand are the zeros of its denominator:

$$z_1 = \frac{-1 + \sqrt{1 - a^2}}{a} \quad \text{and} \quad z_2 = \frac{-1 - \sqrt{1 - a^2}}{a}.$$

For $|a| < 1$ it is clear that z_2 will lie outside the unit circle C ; therefore, it does not contribute to the integral. But z_1 lies inside, and we obtain

$$\oint_C \frac{dz}{2z + az^2 + a} = 2\pi i \operatorname{Res}[f(z_1)].$$

The residue of the simple pole at z_1 can be calculated:

$$\begin{aligned} \operatorname{Res}[f(z_1)] &= \lim_{z \rightarrow z_1} (z - z_1) \frac{1}{a(z - z_1)(z - z_2)} = \frac{1}{a} \left(\frac{1}{z_1 - z_2} \right) \\ &= \frac{1}{a} \left(\frac{a}{2\sqrt{1 - a^2}} \right) = \frac{1}{2\sqrt{1 - a^2}}. \end{aligned}$$

It follows that

$$\int_0^{2\pi} \frac{d\theta}{1 + a \cos \theta} = \frac{2}{i} \oint_C \frac{dz}{2z + az^2 + a} = \frac{2}{i} 2\pi i \left(\frac{1}{2\sqrt{1 - a^2}} \right) = \frac{2\pi}{\sqrt{1 - a^2}}.$$

Example 11.3.7 As another example, let us consider the integral

$$I = \int_0^\pi \frac{d\theta}{(a + \cos \theta)^2} \quad \text{where } a > 1.$$

Since $\cos \theta$ is an even function of θ , we may write

$$I = \frac{1}{2} \int_{-\pi}^\pi \frac{d\theta}{(a + \cos \theta)^2} \quad \text{where } a > 1.$$

This integration is over a complete cycle around the origin, and we can make the usual substitution:

$$I = \frac{1}{2} \oint_C \frac{dz/iz}{[a + (z^2 + 1)/2z]^2} = \frac{2}{i} \oint_C \frac{z dz}{(z^2 + 2az + 1)^2}.$$

The denominator has the roots $z_1 = -a + \sqrt{a^2 - 1}$ and $z_2 = -a - \sqrt{a^2 - 1}$, which are both of order 2. The second root is outside the unit circle because $a > 1$. Also, it is easily verified that for all $a > 1$, z_1 is inside the unit circle.

Since z_1 is a pole of order 2, we have

$$\begin{aligned}\operatorname{Res}[f(z_1)] &= \lim_{z \rightarrow z_1} \frac{d}{dz} \left[(z - z_1)^2 \frac{z}{(z - z_1)^2 (z - z_2)^2} \right] \\ &= \lim_{z \rightarrow z_1} \frac{d}{dz} \left[\frac{z}{(z - z_2)^2} \right] = \frac{1}{(z_1 - z_2)^2} - \frac{2z_1}{(z_1 - z_2)^3} \\ &= \frac{a}{4(a^2 - 1)^{3/2}}.\end{aligned}$$

We thus obtain $I = \frac{2}{i} 2\pi i \operatorname{Res}[f(z_1)] = \frac{\pi a}{(a^2 - 1)^{3/2}}$.

11.3.4 Some Other Integrals

The three types of definite integrals discussed above do not exhaust all possible applications of the residue theorem. There are other integrals that do not fit into any of the foregoing three categories but are still manageable. As the next two examples demonstrate, a clever choice of contours allows evaluation of other types of integrals.

Example 11.3.8 Let us evaluate the Gaussian integral

$$I = \int_{-\infty}^{\infty} e^{iax - bx^2} dx \quad \text{where } a, b \in \mathbb{R}, b > 0.$$

Completing squares in the exponent, we have

$$I = \int_{-\infty}^{\infty} e^{-b[x - ia/(2b)]^2 - a^2/4b} dx = e^{-a^2/4b} \lim_{R \rightarrow \infty} \int_{-R}^R e^{-b[x - ia/(2b)]^2} dx.$$

If we change the variable of integration to $z = x - ia/(2b)$, we obtain

$$I = e^{-a^2/(4b)} \lim_{R \rightarrow \infty} \int_{-R - ia/(2b)}^{R - ia/(2b)} e^{-bz^2} dz.$$

Let us now define I_R :

$$I_R \equiv \int_{-R - ia/(2b)}^{R - ia/(2b)} e^{-bz^2} dz.$$

This is an integral along a straight line C_1 that is parallel to the x -axis (see Fig. 11.3). We close the contour as shown and note that e^{-bz^2} is analytic throughout the interior of the closed contour (it is an entire function!). Thus, the contour integral must vanish by the Cauchy-Goursat theorem. So we obtain

$$I_R + \int_{C_3} e^{-bz^2} dz + \int_R^{-R} e^{-bx^2} dx + \int_{C_4} e^{-bz^2} dz = 0.$$

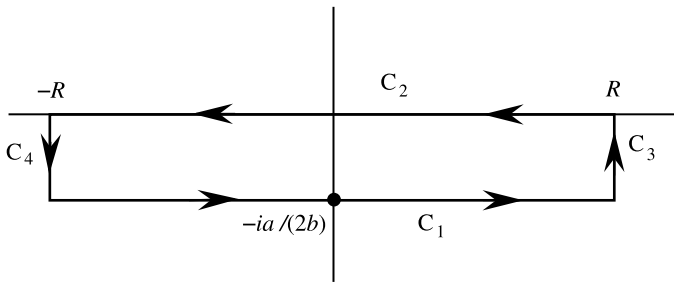

Fig. 11.3 The contour for the evaluation of the Gaussian integral

Along C_3 , $z = R + iy$ and

$$\int_{C_3} e^{-bz^2} dz = \int_{-ia/(2b)}^0 e^{-b(R+iy)^2} i dy = ie^{-bR^2} \int_{-ia/(2b)}^0 e^{by^2 - 2ibRy} dy$$

which clearly tends to zero as $R \rightarrow \infty$. We get a similar result for the integral along C_4 . Therefore, we have

$$I_R = \int_{-R}^R e^{-bx^2} dx \Rightarrow \lim_{R \rightarrow \infty} I_R = \int_{-\infty}^{\infty} e^{-bx^2} dx = \sqrt{\frac{\pi}{b}}.$$

Finally, we get

$$\int_{-\infty}^{\infty} e^{iax - bx^2} dx = \sqrt{\frac{\pi}{b}} e^{-a^2/(4b)}.$$

Example 11.3.9 Let us evaluate $I = \int_0^{\infty} dx/(x^3 + 1)$. If the integrand were even, we could extend the lower limit of integration to $-\infty$ and close the contour in the UHP. Since this is not the case, we need to use a different trick. To get a hint as to how to close the contour, we study the singularities of the integrand. These are simply the roots of the denominator: $z^3 = -1$ or $z_n = e^{i(2n+1)\pi/3}$ with $n = 0, 1, 2$. These, as well as a contour that has only z_0 as an interior point, are shown in Fig. 11.4. We thus have

$$I + \int_{C_R} \frac{dz}{z^3 + 1} + \int_{C_2} \frac{dz}{z^3 + 1} = 2\pi i \operatorname{Res}[f(z_0)]. \quad (11.8)$$

The C_R integral vanishes, as usual. Along C_2 , $z = re^{i\alpha}$, with constant α , so that $dz = e^{i\alpha} dr$ and

$$\int_{C_2} \frac{dz}{z^3 + 1} = \int_{\infty}^0 \frac{e^{i\alpha} dr}{(re^{i\alpha})^3 + 1} = -e^{i\alpha} \int_0^{\infty} \frac{dr}{r^3 e^{3i\alpha} + 1}.$$

In particular, if we choose $3\alpha = 2\pi$, we obtain

$$\int_{C_2} \frac{dz}{z^3 + 1} = -e^{i2\pi/3} \int_0^{\infty} \frac{dr}{r^3 + 1} = -e^{i2\pi/3} I.$$

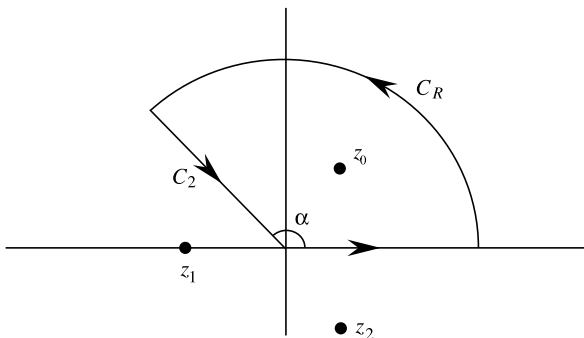

Fig. 11.4 The contour is chosen so that only one of the poles lies inside

Substituting this in Eq. (11.8) gives

$$(1 - e^{i2\pi/3})I = 2\pi i \operatorname{Res}[f(z_0)] \Rightarrow I = \frac{2\pi i}{1 - e^{i2\pi/3}} \operatorname{Res}[f(z_0)].$$

On the other hand,

$$\begin{aligned} \operatorname{Res}[f(z_0)] &= \lim_{z \rightarrow z_0} (z - z_0) \frac{1}{(z - z_0)(z - z_1)(z - z_2)} \\ &= \frac{1}{(z_0 - z_1)(z_0 - z_2)} = \frac{1}{(e^{i\pi/3} - e^{i\pi})(e^{i\pi/3} - e^{i5\pi/3})}. \end{aligned}$$

These last two equations yield

$$I = \frac{2\pi i}{1 - e^{i2\pi/3}} \frac{1}{(e^{i\pi/3} - e^{i\pi})(e^{i\pi/3} - e^{i5\pi/3})} = \frac{2\pi}{3\sqrt{3}}.$$

11.3.5 Principal Value of an Integral

So far we have discussed only integrals of functions that have no singularities on the contour. Let us now investigate the consequences of the presence of singular points on the contour. Consider the integral

$$\int_{-\infty}^{\infty} \frac{f(x)}{x - x_0} dx, \tag{11.9}$$

where x_0 is a real number and f is analytic at x_0 . To avoid x_0 —which causes the integrand to diverge—we bypass it by indenting the contour as shown in Fig. 11.5 and denoting the new contour by C_u . The contour C_0 is simply a semicircle of radius ϵ . For the contour C_u , we have

$$\int_{C_u} \frac{f(z)}{z - x_0} dz = \int_{-\infty}^{x_0 - \epsilon} \frac{f(x)}{x - x_0} dx + \int_{x_0 + \epsilon}^{\infty} \frac{f(x)}{x - x_0} dx + \int_{C_0} \frac{f(z)}{z - x_0} dz.$$

principal value of an integral In the limit $\epsilon \rightarrow 0$, the sum of the first two terms on the RHS—when it exists—defines the **principal value** of the integral in Eq. (11.9):

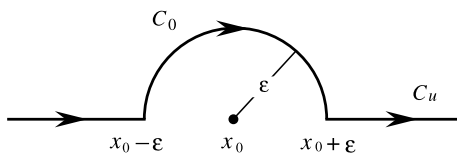

Fig. 11.5 The contour C_u avoids x_0

$$P \int_{-\infty}^{\infty} \frac{f(x)}{x - x_0} dx = \lim_{\epsilon \rightarrow 0} \left[\int_{-\infty}^{x_0 - \epsilon} \frac{f(x)}{x - x_0} dx + \int_{x_0 + \epsilon}^{\infty} \frac{f(x)}{x - x_0} dx \right].$$

The integral over the semicircle is calculated by noting that $z - x_0 = \epsilon e^{i\theta}$ and $dz = i\epsilon e^{i\theta} d\theta$: $\int_{C_0} f(z) dz / (z - x_0) = -i\pi f(x_0)$. Therefore,

$$\int_{C_u} \frac{f(z)}{z - x_0} dz = P \int_{-\infty}^{\infty} \frac{f(x)}{x - x_0} dx - i\pi f(x_0). \tag{11.10}$$

On the other hand, if C_0 is taken below the singularity on a contour C_d , say, we obtain

$$\int_{C_d} \frac{f(z)}{z - x_0} dz = P \int_{-\infty}^{\infty} \frac{f(x)}{x - x_0} dx + i\pi f(x_0).$$

We see that the contour integral depends on how the singular point x_0 is avoided. However, the principal value, if it exists, is unique. To calculate this principal value we close the contour by adding a large semicircle to it as before, assuming that the contribution from this semicircle goes to zero by Jordan’s lemma. The contours C_u and C_d are replaced by a closed contour, and the value of the integral will be given by the residue theorem. We therefore have

$$P \int_{-\infty}^{\infty} \frac{f(x)}{x - x_0} dx = \pm i\pi f(x_0) + 2\pi i \sum_{j=1}^m \text{Res} \left[\frac{f(z_j)}{z_j - x_0} \right], \tag{11.11}$$

where $\{z_j\}_{j=1}^m$ are the poles of $f(z)$, the plus sign corresponds to placing the infinitesimal semicircle in the UHP, as shown in Fig. 11.5, and the minus sign corresponds to the other choice.

Example 11.3.10 Let us use the principal-value method to evaluate the integral

$$I = \int_0^{\infty} \frac{\sin x}{x} dx = \frac{1}{2} \int_{-\infty}^{\infty} \frac{\sin x}{x} dx.$$

It appears that $x = 0$ is a singular point of the integrand; in reality, however, it is only a removable singularity, as can be verified by the Taylor expansion of $\sin x/x$. To make use of the principal-value method, we write

$$I = \frac{1}{2} \text{Im} \left(\int_{-\infty}^{\infty} \frac{e^{ix}}{x} dx \right) = \frac{1}{2} \text{Im} \left(P \int_{-\infty}^{\infty} \frac{e^{ix}}{x} dx \right).$$

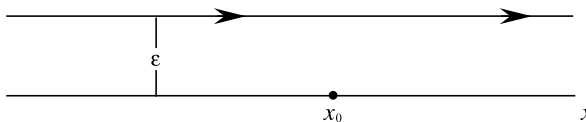

Fig. 11.6 The equivalent contour obtained by “stretching” C_u , the contour of Fig. 11.5

We now use Eq. (11.11) with the small circle in the UHP, noting that there are no singularities for e^{ix}/x there. This yields

$$P \int_{-\infty}^{\infty} \frac{e^{ix}}{x} dx = i\pi e^{(0)} = i\pi.$$

Therefore,

$$\int_0^{\infty} \frac{\sin x}{x} dx = \frac{1}{2} \text{Im}(i\pi) = \frac{\pi}{2}.$$

The principal value of an integral can be written more compactly if we deform the contour C_u by stretching it into that shown in Fig. 11.6. For small enough ϵ , such a deformation will not change the number of singularities within the infinite closed contour. Thus, the LHS of Eq. (11.10) will have limits of integration $-\infty + i\epsilon$ and $+\infty + i\epsilon$. If we change the variable of integration to $\xi = z - i\epsilon$, this integral becomes

$$\int_{-\infty}^{\infty} \frac{f(\xi + i\epsilon)}{\xi + i\epsilon - x_0} d\xi = \int_{-\infty}^{\infty} \frac{f(\xi) d\xi}{\xi - x_0 + i\epsilon} = \int_{-\infty}^{\infty} \frac{f(z) dz}{z - x_0 + i\epsilon}, \quad (11.12)$$

where in the last step we changed the dummy integration variable back to z . Note that since f is assumed to be continuous at all points on the contour, $f(\xi + i\epsilon) \rightarrow f(\xi)$ for small ϵ . The last integral of Eq. (11.12) shows that there is no singularity on the new x -axis; we have pushed the singularity down to $x_0 - i\epsilon$. In other words, we have given the singularity on the x -axis a small negative imaginary part. We can thus rewrite Eq. (11.10) as

$$P \int_{-\infty}^{\infty} \frac{f(x)}{x - x_0} dx = i\pi f(x_0) + \int_{-\infty}^{\infty} \frac{f(x) dx}{x - x_0 + i\epsilon},$$

where x is used instead of z in the last integral because we are indeed integrating along the new x -axis—assuming that no other singularities are present in the UHP. A similar argument, this time for the LHP, introduces a minus sign for the first term on the RHS and for the ϵ term in the denominator. Therefore,

Proposition 11.3.11 *The principal value of an integral with one simple pole on the real axis is*

$$P \int_{-\infty}^{\infty} \frac{f(x)}{x - x_0} dx = \pm i\pi f(x_0) + \int_{-\infty}^{\infty} \frac{f(x) dx}{x - x_0 \pm i\epsilon}, \quad (11.13)$$

where the plus (minus) sign refers to the UHP (LHP).

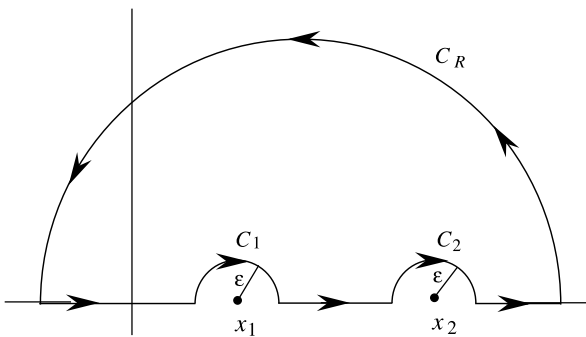

Fig. 11.7 One of the four choices of contours for evaluating the principal value of the integral when there are two poles on the real axis

This result is sometimes abbreviated as

$$\frac{1}{x - x_0 \pm i\epsilon} = P \frac{1}{x - x_0} \mp i\pi\delta(x - x_0). \tag{11.14}$$

Example 11.3.12 Let us use residues to evaluate the function

$$f(k) = \frac{1}{2\pi i} \int_{-\infty}^{\infty} \frac{e^{ikx} dx}{x - i\epsilon}, \quad \epsilon > 0.$$

We have to close the contour by adding a large semicircle. Whether we do this in the UHP or the LHP is dictated by the sign of k : If $k > 0$, we close in the UHP. Thus,

The integral representation of the θ (step) function

$$\begin{aligned} f(k) &= \frac{1}{2\pi i} \int_C \frac{e^{ikz} dz}{z - i\epsilon} = \text{Res} \left[\frac{e^{ikz}}{z - i\epsilon} \right]_{z \rightarrow i\epsilon} \\ &= \lim_{z \rightarrow i\epsilon} \left[(z - i\epsilon) \frac{e^{ikz}}{z - i\epsilon} \right] = e^{-k\epsilon} \xrightarrow{\epsilon \rightarrow 0} 1. \end{aligned}$$

On the other hand, if $k < 0$, we must close in the LHP, in which the integrand is analytic. Thus, by the Cauchy-Goursat theorem, the integral vanishes. Therefore, we have

$$f(k) = \begin{cases} 1 & \text{if } k > 0, \\ 0 & \text{if } k < 0. \end{cases}$$

This is precisely the definition of the **theta function** (or step function). Thus, we have obtained an integral representation of that function:

theta (or step) function

$$\theta(x) = \frac{1}{2\pi i} \int_{-\infty}^{\infty} \frac{e^{ixt}}{t - i\epsilon} dt.$$

Now suppose that there are two singular points on the real axis, at x_1 and x_2 . Let us avoid x_1 and x_2 by making little semicircles, as before, letting both semicircles be in the UHP (see Fig. 11.7). Without writing the integrands,

we can represent the contour integral by

$$\int_{-\infty}^{x_1-\epsilon} + \int_{C_1} + \int_{x_1+\epsilon}^{x_2-\epsilon} + \int_{C_2} + \int_{x_2+\epsilon}^{\infty} + \int_{C_R} = 2\pi i \sum \text{Res.}$$

The principal value of the integral is naturally defined to be the sum of all integrals having ϵ in their limits. The contribution from the small semicircle C_1 can be calculated by substituting $z - x_1 = \epsilon e^{i\theta}$ in the integral:

$$\int_{C_1} \frac{f(z) dz}{(z-x_1)(z-x_2)} = \int_{\pi}^0 \frac{f(x_1 + \epsilon e^{i\theta}) i \epsilon e^{i\theta} d\theta}{\epsilon e^{i\theta} (x_1 + \epsilon e^{i\theta} - x_2)} = -i\pi \frac{f(x_1)}{x_1 - x_2},$$

with a similar result for C_2 . Putting everything together, we get

$$P \int_{-\infty}^{\infty} \frac{f(x)}{(x-x_1)(x-x_2)} dx - i\pi \frac{f(x_2) - f(x_1)}{x_2 - x_1} = 2\pi i \sum \text{Res.}$$

If we include the case where both C_1 and C_2 are in the LHP, we get

$$P \int_{-\infty}^{\infty} \frac{f(x)}{(x-x_1)(x-x_2)} dx = \pm i\pi \frac{f(x_2) - f(x_1)}{x_2 - x_1} + 2\pi i \sum \text{Res}, \quad (11.15)$$

where the plus sign is for the case where C_1 and C_2 are in the UHP and the minus sign for the case where both are in the LHP. We can also obtain the result for the case where the two singularities coincide by taking the limit $x_1 \rightarrow x_2$. Then the RHS of the last equation becomes a derivative, and we obtain

$$P \int_{-\infty}^{\infty} \frac{f(x)}{(x-x_0)^2} dx = \pm i\pi f'(x_0) + 2\pi i \sum \text{Res.}$$

Example 11.3.13 An expression encountered in the study of Green's functions or propagators (which we shall discuss later in the book) is

$$\int_{-\infty}^{\infty} \frac{e^{itx} dx}{x^2 - k^2},$$

where k and t are real constants. We want to calculate the principal value of this integral. We use Eq. (11.15) and note that for $t > 0$, we need to close the contour in the UHP, where there are no poles:

$$P \int_{-\infty}^{\infty} \frac{e^{itx} dx}{x^2 - k^2} = P \int_{-\infty}^{\infty} \frac{e^{itx} dx}{(x-k)(x+k)} = i\pi \frac{e^{ikt} - e^{-ikt}}{2k} = -\pi \frac{\sin kt}{k}.$$

When $t < 0$, we have to close the contour in the LHP, where again there are no poles:

$$P \int_{-\infty}^{\infty} \frac{e^{itx} dx}{x^2 - k^2} = P \int_{-\infty}^{\infty} \frac{e^{itx} dx}{(x-k)(x+k)} = -i\pi \frac{e^{ikt} - e^{-ikt}}{2k} = \pi \frac{\sin kt}{k}.$$

The two results above can be combined into a single relation:

$$P \int_{-\infty}^{\infty} \frac{e^{itx} dx}{x^2 - k^2} = -\pi \frac{\sin k|t|}{k}.$$

11.4 Problems

11.1 Evaluate each of the following integrals, for all of which C is the circle $|z| = 3$.

$$\begin{array}{ll}
 \text{(a)} \quad \oint_C \frac{4z-3}{z(z-2)} dz. & \text{(b)} \quad \oint_C \frac{e^z}{z(z-i\pi)} dz. \\
 \text{(c)} \quad \oint_C \frac{\cos z}{z(z-\pi)} dz. & \text{(d)} \quad \oint_C \frac{z^2+1}{z(z-1)} dz. \\
 \text{(e)} \quad \oint_C \frac{\cosh z}{z^2+\pi^2} dz. & \text{(f)} \quad \oint_C \frac{1-\cos z}{z^2} dz. \\
 \text{(g)} \quad \oint_C \frac{\sinh z}{z^4} dz. & \text{(h)} \quad \oint_C z \cos\left(\frac{1}{z}\right) dz. \\
 \text{(i)} \quad \oint_C \frac{dz}{z^3(z+5)}. & \text{(j)} \quad \oint_C \tan z dz. \\
 \text{(k)} \quad \oint_C \frac{dz}{\sinh 2z}. & \text{(l)} \quad \oint_C \frac{e^z}{z^2} dz. \\
 \text{(m)} \quad \oint_C \frac{dz}{z^2 \sin z}. & \text{(n)} \quad \oint_C \frac{e^z dz}{(z-1)(z-2)}.
 \end{array}$$

11.2 Let $h(z)$ be analytic and have a simple zero at $z = z_0$, and let $g(z)$ be analytic there. Let $f(z) = g(z)/h(z)$, and show that

$$\operatorname{Res}[f(z_0)] = \frac{g(z_0)}{h'(z_0)}.$$

11.3 Find the residue of $f(z) = 1/\cos z$ at each of its poles.

11.4 Evaluate the integral $\int_0^\infty dx / [(x^2+1)(x^2+4)]$ by closing the contour (a) in the UHP and (b) in the LHP.

11.5 Evaluate the following integrals, in which a and b are nonzero real constants.

$$\begin{array}{ll}
 \text{(a)} \quad \int_0^\infty \frac{2x^2+1}{x^4+5x^2+6} dx. & \text{(b)} \quad \int_0^\infty \frac{dx}{6x^4+5x^2+1}. \\
 \text{(c)} \quad \int_0^\infty \frac{dx}{x^4+1}. & \text{(d)} \quad \int_0^\infty \frac{\cos x dx}{(x^2+a^2)^2(x^2+b^2)}. \\
 \text{(e)} \quad \int_0^\infty \frac{\cos ax}{(x^2+b^2)^2} dx. & \text{(f)} \quad \int_0^\infty \frac{dx}{(x^2+1)^2}. \\
 \text{(g)} \quad \int_0^\infty \frac{dx}{(x^2+1)^2(x^2+2)}. & \text{(h)} \quad \int_0^\infty \frac{2x^2-1}{x^6+1} dx.
 \end{array}$$

$$\begin{array}{ll}
 \text{(i)} \int_0^{\infty} \frac{x^2 dx}{(x^2 + a^2)^2} & \text{(j)} \int_{-\infty}^{\infty} \frac{x dx}{(x^2 + 4x + 13)^2} \\
 \text{(k)} \int_0^{\infty} \frac{x^3 \sin ax}{x^6 + 1} dx & \text{(l)} \int_0^{\infty} \frac{x^2 + 1}{x^2 + 4} dx \\
 \text{(m)} \int_{-\infty}^{\infty} \frac{x \cos x dx}{x^2 - 2x + 10} & \text{(n)} \int_{-\infty}^{\infty} \frac{x \sin x dx}{x^2 - 2x + 10} \\
 \text{(o)} \int_0^{\infty} \frac{dx}{x^2 + 1} & \text{(p)} \int_0^{\infty} \frac{x^2 dx}{(x^2 + 4)^2(x^2 + 25)} \\
 \text{(q)} \int_0^{\infty} \frac{\cos ax}{x^2 + b^2} dx & \text{(r)} \int_0^{\infty} \frac{dx}{(x^2 + 4)^2}
 \end{array}$$

11.6 Evaluate each of the following integrals by turning it into a contour integral around a unit circle.

$$\begin{array}{ll}
 \text{(a)} \int_0^{2\pi} \frac{d\theta}{5 + 4 \sin \theta} & \\
 \text{(b)} \int_0^{2\pi} \frac{d\theta}{a + \cos \theta} & \text{where } a > 1. \\
 \text{(c)} \int_0^{2\pi} \frac{d\theta}{1 + \sin^2 \theta} & \\
 \text{(d)} \int_0^{2\pi} \frac{d\theta}{(a + b \cos^2 \theta)^2} & \text{where } a, b > 0. \\
 \text{(e)} \int_0^{2\pi} \frac{\cos^2 3\theta}{5 - 4 \cos 2\theta} d\theta & \\
 \text{(f)} \int_0^{\pi} \frac{d\phi}{1 - 2a \cos \phi + a^2} & \text{where } a \neq \pm 1. \\
 \text{(g)} \int_0^{\pi} \frac{\cos^2 3\phi d\phi}{1 - 2a \cos \phi + a^2} & \text{where } a \neq \pm 1. \\
 \text{(h)} \int_0^{\pi} \frac{\cos 2\phi d\phi}{1 - 2a \cos \phi + a^2} & \text{where } a \neq \pm 1. \\
 \text{(i)} \int_0^{\pi} \tan(x + ia) dx & \text{where } a \in \mathbb{R}. \\
 \text{(j)} \int_0^{\pi} e^{\cos \phi} \cos(n\phi - \sin \phi) d\phi & \text{where } n \in \mathbb{Z}.
 \end{array}$$

11.7 Evaluate the integral $I = \int_{-\infty}^{\infty} e^{\alpha x} dx / (1 + e^x)$ for $0 < \alpha < 1$. Hint: Choose a closed (long) rectangle that encloses only one of the zeros of the denominator. Show that the contributions of the short sides of the rectangle are zero.

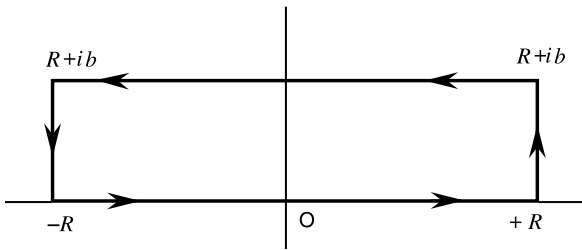

Fig. 11.8 The contour used in Problem 11.8

11.8 Derive the integration formula $\int_0^\infty e^{-x^2} \cos(2bx) dx = \frac{\sqrt{\pi}}{2} e^{-b^2}$ where $b \neq 0$ by integrating the function e^{-z^2} around the rectangular path shown in Fig. 11.8.

11.9 Use the result of Example 11.3.12 to show that $\theta'(k) = \delta(k)$.

11.10 Find the principal values of the following integrals.

$$(a) \int_{-\infty}^{\infty} \frac{\sin x dx}{(x^2 + 4)(x - 1)}. \quad (b) \int_{-\infty}^{\infty} \frac{\cos ax}{1 + x^3} dx \quad \text{where } a \geq 0.$$

$$(c) \int_{-\infty}^{\infty} \frac{x \cos x}{x^2 - 5x + 6} dx. \quad (d) \int_{-\infty}^{\infty} \frac{1 - \cos x}{x^2} dx.$$

11.11 Evaluate the following integrals.

$$(a) \int_0^\infty \frac{x^2 - b^2}{x^2 + b^2} \left(\frac{\sin ax}{x} \right) dx. \quad (b) \int_0^\infty \frac{\sin ax}{x(x^2 + b^2)} dx.$$

$$(c) \int_0^\infty \frac{\sin ax}{x(x^2 + b^2)^2} dx. \quad (d) \int_0^\infty \frac{\cos 2ax - \cos 2bx}{x^2} dx.$$

$$(e) \int_0^\infty \frac{\sin^2 x dx}{x^2}. \quad (f) \int_0^\infty \frac{\sin^3 x dx}{x^3}.$$

The subject of complex analysis is an extremely rich and powerful area of mathematics. We have already seen some of this richness and power in the previous chapter. This chapter concludes our discussion of complex analysis by introducing some other topics with varying degrees of importance.

12.1 Meromorphic Functions

Complex functions that have only simple poles as their singularities are numerous in applications and are called **meromorphic functions**. In this section, we derive an important result for such functions.

Suppose that $f(z)$ has simple poles at $\{z_j\}_{j=1}^N$, where N could be infinity. Then, assuming that $z \neq z_j$ for all j , and noting that the residue of $f(\xi)/(\xi - z)$ at $\xi = z$ is simply $f(z)$, the residue theorem yields

$$\frac{1}{2\pi i} \int_{C_n} \frac{f(\xi)}{\xi - z} d\xi = f(z) + \sum_{j=1}^n \text{Res}\left(\frac{f(\xi)}{\xi - z}\right)_{\xi=z_j},$$

where C_n is a circle containing the first n poles, and it is assumed that the poles are arranged in order of increasing absolute values. Since the poles of f are assumed to be simple, we have

$$\begin{aligned} \text{Res}\left(\frac{f(\xi)}{\xi - z}\right)_{\xi=z_j} &= \lim_{\xi \rightarrow z_j} (\xi - z_j) \frac{f(\xi)}{\xi - z} = \frac{1}{z_j - z} \lim_{\xi \rightarrow z_j} [(\xi - z_j)f(\xi)] \\ &= \frac{1}{z_j - z} \text{Res}[f(\xi)]_{\xi=z_j} \equiv \frac{r_j}{z_j - z}, \end{aligned}$$

where r_j is, by definition, the residue of $f(\xi)$ at $\xi = z_j$. Substituting in the preceding equation gives

$$f(z) = \frac{1}{2\pi i} \int_{C_n} \frac{f(\xi)}{\xi - z} d\xi - \sum_{j=1}^n \frac{r_j}{z_j - z}.$$

Taking the difference between this and the same equation evaluated at $z = 0$ (assumed to be none of the poles),¹ we can write

$$f(z) - f(0) = \frac{z}{2\pi i} \int_{C_n} \frac{f(\xi)}{\xi(\xi - z)} d\xi + \sum_{j=1}^n r_j \left(\frac{1}{z - z_j} + \frac{1}{z_j} \right).$$

If $|f(\xi)|$ approaches a finite value as $|\xi| \rightarrow \infty$, the integral vanishes for an infinite circle (which includes all poles now), and we obtain what is called the **Mittag-Leffler expansion** of the meromorphic function f :

$$f(z) = f(0) + \sum_{j=1}^N r_j \left(\frac{1}{z - z_j} + \frac{1}{z_j} \right). \quad (12.1)$$

Now we let g be an entire function with *simple zeros*. We claim that (a) $(dg/dz)/g(z)$ is a meromorphic function that is bounded for all values of z , and (b) its residues are all unity. To see this, note that g is of the form²

$$g(z) = (z - z_1)(z - z_2) \cdots (z - z_N) f(z),$$

where z_1, \dots, z_N are all the zeros of g , and f is an analytic function that does not vanish anywhere in the complex plane. It is now easy to see that

$$\frac{g'(z)}{g(z)} = \sum_{j=1}^N \frac{1}{z - z_j} + \frac{f'(z)}{f(z)}.$$

This expression has both properties (a) and (b) mentioned above. Furthermore, the last term is an entire function that is bounded for all \mathbb{C} . Therefore, it must be a constant by Proposition 10.5.5. This derivation also verifies Eq. (12.1), which in the case at hand can be written as

$$\frac{d}{dz} \ln g(z) = \frac{g'(z)}{g(z)} = \frac{d}{dz} \ln g(0) + \sum_{j=1}^N \left(\frac{1}{z - z_j} + \frac{1}{z_j} \right),$$

whose solution is readily found and is given in the following

Proposition 12.1.1 *If g is an entire function with simple zeros $\{z_j\}_{j=1}^N$, then*

$$g(z) = g(0)e^{cz} \prod_{j=1}^N \left(1 - \frac{z}{z_j} \right) e^{z/z_j} \quad \text{where} \quad c = \frac{(dg/dz)|_{z=0}}{g(0)} \quad (12.2)$$

and it is assumed that $z_j \neq 0$ for all j .

¹This is not a restrictive assumption because we can always move our coordinate system so that the origin avoids all poles.

²One can “prove” this by factoring the simple zeros one by one, writing $g(z) = (z - z_1)f_1(z)$ and noting that $g(z_2) = 0$, with $z_2 \neq z_1$, implies that $f_1(z) = (z - z_2)f_2(z)$, etc.

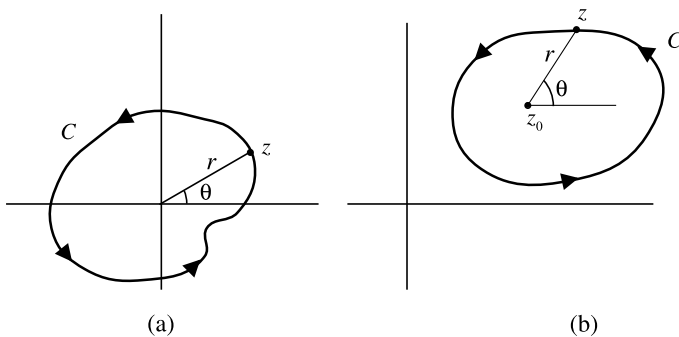

Fig. 12.1 (a) The origin is a branch point of the natural log function. (b) z_0 is a branch point of $f(z)$ if $f(z_0 + re^{i\theta}) \neq f(z_0 + re^{i(\theta+2\pi)})$

12.2 Multivalued Functions

The arbitrariness, up to a multiple of 2π , of the angle $\theta = \arg(z)$ in $z = re^{i\theta}$ leads to functions that can take different values at the same point. Consider, for example, the function $f(z) = \sqrt{z}$. Writing z in polar coordinates, we obtain $f(z) = f(r, \theta) = (re^{i\theta})^{1/2} = \sqrt{r}e^{i\theta/2}$. This shows that for the same $z = (r, \theta) = (r, \theta + 2\pi)$, we get two different values, $f(r, \theta)$ and $f(r, \theta + 2\pi) = -f(r, \theta)$.

This may be disturbing at first. After all, the definition of a function (mapping) ensures that for any point in the domain a *unique* image is obtained. Here two different images are obtained for the same z . Riemann found a cure for this complex “double vision” by introducing what is now called Riemann sheets. We will discuss these briefly below, but first let us take a closer look at a prototype of multivalued functions. Consider the natural log function, $\ln z$. For $z = re^{i\theta}$ this is defined as $\ln z = \ln r + i\theta = \ln |z| + i \arg(z)$ where $\arg(z)$ is defined only to within a multiple of 2π ; that is, $\arg(z) = \theta + 2n\pi$, for $n = 0, \pm 1, \pm 2, \dots$

We can see the peculiar nature of the logarithmic function by considering a closed curve around the origin, as shown in Fig. 12.1(a). Starting at an arbitrary point z on the curve, we move counterclockwise, noticing the constant increase in the angle θ , until we reach the initial point. Now, the angle is $\theta + 2\pi$. Thus, the process of moving around the origin has changed the value of the log function by $2\pi i$, i.e., $(\ln z)_{\text{final}} - (\ln z)_{\text{initial}} = 2\pi i$. Note that in this process z does not change, because

$$z_{\text{final}} = re^{i(\theta+2\pi)} = re^{i\theta} e^{2\pi i} = re^{i\theta} = z_{\text{initial}}.$$

Definition 12.2.1 A **branch point** of a function $f : \mathbb{C} \rightarrow \mathbb{C}$ is a complex number z_0 with the property that for any (small enough) closed curve C encircling z_0 and for any point $z \equiv z_0 + re^{i\theta}$ on the curve, $f(z_0 + re^{i\theta}) \neq f(z_0 + re^{i(\theta+2\pi)})$. branch point

Historical Notes

Victor-Alexandre Puiseux (1820–1883) was the first to take up the subject of multivalued functions. In 1850 Puiseux published a celebrated paper on complex algebraic functions given by $f(u, z) = 0$, f a polynomial in u and z . He first made clear the distinction

between **poles** and **branch points** that Cauchy had barely perceived, and introduced the notion of an **essential singular point**, to which Weierstrass independently had called attention. Though Cauchy, in the 1846 paper, did consider the variation of simple multivalued functions along paths that enclosed branch points, Puiseux clarified this subject too.

Puiseux also showed that the development of a function of z about a branch point $z = a$ must involve *fractional powers* of $z - a$. He then improved on Cauchy's theorem on the expansion of a function in a Maclaurin series. By his significant investigations of many-valued functions and their branch points in the complex plane, and by his initial work on integrals of such functions, Puiseux brought Cauchy's pioneering work in function theory to the end of what might be called the first stage. The difficulties in the theory of multiple-valued functions and integrals of such functions were still to be overcome. Cauchy did write other papers on the integrals of multivalued functions in which he attempted to follow up on Puiseux's work; and though he introduced the notion of branch cuts (*lignes d'arrêt*), he was still confused about the distinction between poles and branch points. This subject of algebraic functions and their integrals was to be pursued by Riemann. Puiseux was a keen mountaineer and was the first to scale the Alpine peak that is now named after him.

Thus, $z = 0$ is a branch point of the logarithmic function. Studying the behavior of $\ln(1/z) = -\ln z$ around $z = 0$ will reveal that the point "at infinity" is also a branch point of $\ln z$. If $z_0 \neq 0$ is any other point of the complex plane, then choosing C to be a small loop, we get

$$\begin{aligned}\ln(z_0 + re^{i\phi}) &= \ln \left[z_0 \left(1 + \frac{re^{i\phi}}{z_0} \right) \right] = \ln z_0 + \ln \left(1 + \frac{re^{i\phi}}{z_0} \right) \\ &\approx \ln z_0 + \frac{re^{i\phi}}{z_0} \quad \text{for } r \ll |z_0|.\end{aligned}$$

It is now clear that $\ln(z_0 + re^{i\theta}) = \ln(z_0 + re^{i(\theta+2\pi)})$. We therefore conclude that any point of the complex plane other than the origin cannot be a branch point of the natural log function.

12.2.1 Riemann Surfaces

The idea of a Riemann surface begins with the removal of all points that lie on the line (or any other curve) joining two branch points. For $\ln z$ this means the removal of all points lying on a curve that starts at $z = 0$ and extends all the way to infinity. Such a curve is called a **branch cut**, or simply a *cut*.

Let us concentrate on $\ln z$ and take the cut to be along the negative half of the real axis. Let us also define the functions

$$\begin{aligned}f_n(z) &= f_n(r, \theta) \\ &= \ln r + i(\theta + 2n\pi) \quad \text{for } -\pi < \theta < \pi; r > 0; n = 0, \pm 1, \dots,\end{aligned}$$

so $f_n(z)$ takes on the same values for $-\pi < \theta < \pi$ that $\ln z$ takes in the range $(2n - 1)\pi < \theta < (2n + 1)\pi$. We have replaced the multivalued logarithmic function by a series of different functions that are analytic in the cut z -plane.

This process of cutting the z -plane and then defining a sequence of functions eliminates the contradiction caused by the existence of branch points, since we are no longer allowed to completely encircle a branch point.

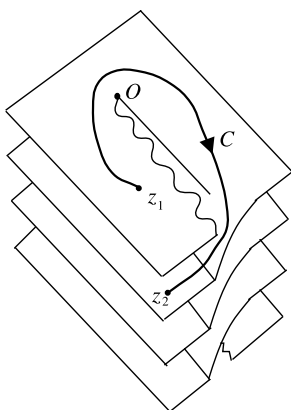

Fig. 12.2 A few sheets of the Riemann surface of the logarithmic function. The path C encircling the origin O ends up on the lower sheet

A complete circulation involves crossing the cut, which, in turn, violates the domain of definition of $f_n(z)$.

We have made good progress. We have replaced the (nonanalytic) multivalued function $\ln z$ with a series of analytic (in their domain of definition) functions $f_n(z)$. However, there is a problem left: $f_n(z)$ has a discontinuity at the cut. In fact, just above the cut $f_n(r, \pi - \epsilon) = \ln r + i(\pi - \epsilon + 2n\pi)$ with $\epsilon > 0$, and just below it $f_n(r, -\pi + \epsilon) = \ln r + i(-\pi + \epsilon + 2n\pi)$, so that

$$\lim_{\epsilon \rightarrow 0} [f_n(r, \pi - \epsilon) - f_n(r, -\pi + \epsilon)] = 2\pi i.$$

To cure this we make the observation that the value of $f_n(z)$ just above the cut is the same as the value of $f_{n+1}(z)$ just below the cut. This suggests the following geometrical construction, due to Riemann: Superpose an infinite series of cut complex planes one on top of the other, each plane corresponding to a different value of n . The adjacent planes are connected along the cut such that the upper lip of the cut in the $(n - 1)$ th plane is connected to the lower lip of the cut in the n th plane. All planes contain the two branch points. That is, the branch points appear as “hinges” at which all the planes are joined. With this geometrical construction, if we cross the cut, we end up on a different plane adjacent to the previous one (Fig. 12.2).

The geometric surface thus constructed is called a **Riemann surface**; each plane is called a **Riemann sheet** and is denoted by R_j , for $j = 0, \pm 1, \pm 2, \dots$. A single-valued function defined on a Riemann sheet is called a **branch** of the original multivalued function.

We have achieved the following: From a multivalued function we have constructed a sequence of single-valued functions, each defined in a single complex plane; from this sequence of functions we have constructed a single complex function defined on a single Riemann surface. Thus, the logarithmic function is analytic throughout the Riemann surface except at the branch points, which are simply the function’s singular points.

Riemann surfaces and sheets

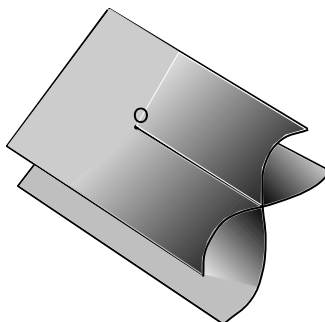

Fig. 12.3 The Riemann surface for $f(z) = z^{1/2}$

It is now easy to see the geometrical significance of branch points. A complete cycle around a branch point takes us to another Riemann sheet, where the function takes on a different form. On the other hand, a complete cycle around an ordinary point either never crosses the cut, or if it does, it will cross it back to the original sheet.

Let us now briefly consider two of the more common multivalued functions and their Riemann surfaces.

Example 12.2.2 (The function $f(z) = z^{1/n}$) The only branch points for the function $f(z) = z^{1/n}$ are $z = 0$ and the point at infinity. Defining $f_k(z) \equiv r^{1/n} e^{i(\theta+2k\pi/n)}$ for $k = 0, 1, \dots, n - 1$ and $0 < \theta < 2\pi$ and following the same procedure as for the logarithmic function, we see that there must be n Riemann sheets, labeled R_0, R_1, \dots, R_{n-1} , in the Riemann surface. The lower edge of R_{n-1} is pasted to the upper edge of R_0 along the cut, which is taken to be along the positive real axis. The Riemann surface for $n = 2$ is shown in Fig. 12.3.

It is clear that for any noninteger value of α the function $f(z) = z^\alpha$ has a branch point at $z = 0$ and another at the point at infinity. For irrational α the number of Riemann sheets is infinite.

Example 12.2.3 (The function $f(z) = (z^2 - 1)^{1/2}$) The branch points for the function $f(z) = (z^2 - 1)^{1/2}$ are at $z_1 = +1$ and $z_2 = -1$ (see Fig. 12.4). Writing $z - 1 = r_1 e^{i\theta_1}$ and $z + 1 = r_2 e^{i\theta_2}$, we have

$$f(z) = (r_1 e^{i\theta_1})^{1/2} (r_2 e^{i\theta_2})^{1/2} = \sqrt{r_1 r_2} e^{i(\theta_1 + \theta_2)/2}.$$

The cut is along the real axis from $z = -1$ to $z = +1$. There are two Riemann sheets in the Riemann surface. Clearly, only cycles of 2π involving *one* branch point will cross the cut and therefore end up on a different sheet. Any closed curve that has both z_1 and z_2 as interior points will remain entirely on the original sheet.

evaluation of integrals involving cuts

The notion of branch cuts can be used to evaluate certain integrals that do not fit into the three categories discussed in Chap. 11. The basic idea is to circumvent the cut by constructing a contour that is infinitesimally close to the cut and circles around branch points.

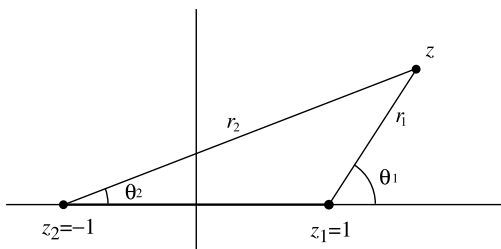

Fig. 12.4 The cut for the function $f(z) = (z^2 - 1)^{1/2}$ is from z_1 to z_2 . Paths that circle only one of the points cross the cut and end up on the other sheet

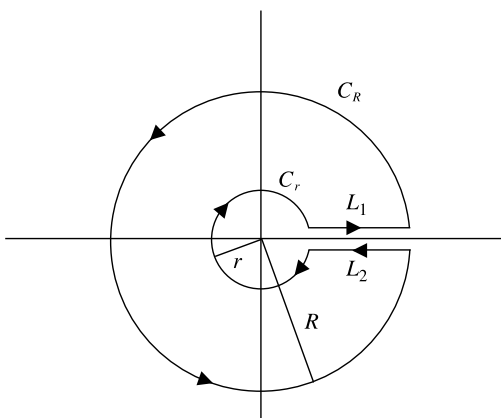

Fig. 12.5 The contour for the evaluation of the integrals of Examples 12.2.4 and 12.2.5

Example 12.2.4 To evaluate the integral $I = \int_0^\infty x^\alpha dx / (x^2 + 1)$ for $|\alpha| < 1$, consider the complex integral $I' = \oint_C z^\alpha dz / (z^2 + 1)$ where C is as shown in Fig. 12.5 and the cut is taken along the positive real axis. To evaluate the contribution from C_R and C_r , we let ρ stand for either r or R . Then we have

$$I_\rho = \int_{C_\rho} \frac{(\rho e^{i\theta})^\alpha}{(\rho e^{i\theta})^2 + 1} i\rho e^{i\theta} d\theta = i \int_0^{2\pi} \frac{\rho^{\alpha+1} e^{i(\alpha+1)\theta}}{\rho^2 e^{2i\theta} + 1} d\theta.$$

It is clear that since $|\alpha| < 1$, $I_\rho \rightarrow 0$ as $\rho \rightarrow 0$ or $\rho \rightarrow \infty$.

The contributions from L_1 and L_2 do not cancel one another because the value of the function changes above and below the cut. To evaluate these two integrals we have to choose a branch of the function. Let us choose that branch on which $z^\alpha = |z|^\alpha e^{i\alpha\theta}$ for $0 < \theta < 2\pi$. Along L_1 , $\theta \approx 0$ or $z^\alpha = x^\alpha$, and along L_2 , $\theta \approx 2\pi$ or $z^\alpha = (xe^{2\pi i})^\alpha$. Thus,

$$\begin{aligned} \oint_C \frac{z^\alpha}{z^2 + 1} dz &= \int_0^\infty \frac{x^\alpha}{x^2 + 1} dx + \int_\infty^0 \frac{x^\alpha e^{2\pi i\alpha}}{(xe^{2\pi i})^2 + 1} dx \\ &= (1 - e^{2\pi i\alpha}) \int_0^\infty \frac{x^\alpha}{x^2 + 1} dx. \end{aligned} \tag{12.3}$$

The LHS of this equation can be obtained using the residue theorem. There are two simple poles, at $z = +i$ and $z = -i$ with residues $\text{Res}[f(i)] = (e^{i\pi/2})^\alpha/2i$ and $\text{Res}[f(-i)] = -(e^{i3\pi/2})^\alpha/2i$. Thus,

$$\oint_C \frac{z^\alpha}{z^2+1} dz = 2\pi i \left(\frac{e^{i\alpha\pi/2}}{2i} - \frac{e^{i3\alpha\pi/2}}{2i} \right) = \pi (e^{i\alpha\pi/2} - e^{i3\alpha\pi/2}).$$

Combining this with Eq. (12.3), we obtain

$$\int_0^\infty \frac{x^\alpha}{x^2+1} dx = \frac{\pi (e^{i\alpha\pi/2} - e^{i3\alpha\pi/2})}{1 - e^{2i\pi\alpha}} = \frac{\pi}{2} \sec \frac{\alpha\pi}{2}.$$

If we had chosen a different branch of the function, both the LHS and the RHS of Eq. (12.3) would have been different, but the final result would still have been the same.

Example 12.2.5 Here is another integral involving a branch cut:

$$I = \int_0^\infty \frac{x^{-a}}{x+1} dx \quad \text{for } 0 < a < 1.$$

To evaluate this integral we use the zeroth branch of the function and the contour of the previous example (Fig. 12.5). Thus, writing $z = \rho e^{i\theta}$, we have

$$\begin{aligned} 2\pi i \text{Res}[f(-1)] &= \oint_C \frac{z^{-a}}{z+1} dz = \int_0^\infty \frac{\rho^{-a}}{\rho+1} d\rho + \oint_{C_R} \frac{z^{-a}}{z+1} dz \\ &\quad + \int_\infty^0 \frac{(\rho e^{2i\pi})^{-a}}{\rho e^{2i\pi} + 1} e^{2i\pi} d\rho + \oint_{C_r} \frac{z^{-a}}{z+1} dz. \end{aligned} \quad (12.4)$$

The contributions from both circles vanish by the same argument used in the previous example. On the other hand, $\text{Res}[f(-1)] = (-1)^{-a}$. For the branch we are using, $-1 = e^{i\pi}$. Thus, $\text{Res}[f(-1)] = e^{-ia\pi}$. The RHS of Eq. (12.4) yields

$$\int_0^\infty \frac{\rho^{-a}}{\rho+1} d\rho - e^{-2i\pi a} \int_0^\infty \frac{\rho^{-a}}{\rho+1} d\rho = (1 - e^{-2i\pi a})I.$$

It follows from (12.4) that $(1 - e^{-2i\pi a})I = 2\pi i e^{-i\pi a}$, or

$$\int_0^\infty \frac{x^{-a}}{x+1} dx = \frac{\pi}{\sin a\pi} \quad \text{for } 0 < a < 1.$$

Example 12.2.6 Let us evaluate $I = \int_0^\infty \ln x dx / (x^2 + a^2)$ with $a > 0$. We choose the zeroth branch of the logarithmic function, in which $-\pi < \theta < \pi$, and use the contour of Fig. 12.6.

For L_1 , $z = \rho e^{i\pi}$ (note that $\rho > 0$), and for L_2 , $z = \rho$. Thus, we have

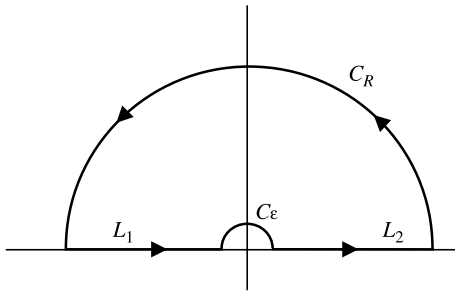

Fig. 12.6 The contour for the evaluation of the integral of Example 12.2.6

$$\begin{aligned}
 2\pi i \operatorname{Res}[f(ia)] &= \oint_C \frac{\ln z}{z^2 + a^2} dz \\
 &= \int_{\infty}^{\epsilon} \frac{\ln(\rho e^{i\pi})}{(\rho e^{i\pi})^2 + a^2} e^{i\pi} d\rho + \int_{C_{\epsilon}} \frac{\ln z}{z^2 + a^2} dz \\
 &\quad + \int_{\epsilon}^{\infty} \frac{\ln \rho}{\rho^2 + a^2} d\rho + \int_{C_R} \frac{\ln z}{z^2 + a^2} dz, \quad (12.5)
 \end{aligned}$$

where $z = ia$ is the only singularity—a simple pole—in the UHP. Now we note that

$$\begin{aligned}
 \int_{\infty}^{\epsilon} \frac{\ln(\rho e^{i\pi})}{(\rho e^{i\pi})^2 + a^2} e^{i\pi} d\rho &= \int_{\epsilon}^{\infty} \frac{\ln \rho + i\pi}{\rho^2 + a^2} d\rho \\
 &= \int_{\epsilon}^{\infty} \frac{\ln \rho}{\rho^2 + a^2} d\rho + i\pi \int_{\epsilon}^{\infty} \frac{d\rho}{\rho^2 + a^2}.
 \end{aligned}$$

The contributions from the circles tend to zero. On the other hand,

$$\operatorname{Res}[f(ia)] = \lim_{z \rightarrow ia} (z - ia) \frac{\ln z}{(z - ia)(z + ia)} = \frac{\ln(ia)}{2ia} = \frac{1}{2ia} \left(\ln a + i\frac{\pi}{2} \right).$$

Substituting the last two results in Eq. (12.5), we obtain

$$\frac{\pi}{a} \left(\ln a + i\frac{\pi}{2} \right) = 2 \int_{\epsilon}^{\infty} \frac{\ln \rho}{\rho^2 + a^2} d\rho + i\pi \int_{\epsilon}^{\infty} \frac{d\rho}{\rho^2 + a^2}.$$

It can also easily be shown that $\int_0^{\infty} d\rho/(\rho^2 + a^2) = \pi/(2a)$. Thus, in the limit $\epsilon \rightarrow 0$, we get $I = \frac{\pi}{2a} \ln a$. The sign of a is irrelevant because it appears as a square in the integral. Thus, we can write

$$\int_0^{\infty} \frac{\ln x}{x^2 + a^2} dx = \frac{\pi}{2|a|} \ln |a|, \quad a \neq 0.$$

12.3 Analytic Continuation

Analytic functions have certain unique properties, some of which we have already noted. For instance, the Cauchy integral formula gives the value of an analytic function inside a simple closed contour once its value on the contour is known. We have also seen that we can deform the contours of integration as long as we do not encounter any singularities of the function.

Combining these two properties and assuming that $f : \mathbb{C} \rightarrow \mathbb{C}$ is analytic within a region $S \subset \mathbb{C}$, we can ask the following question: Is it possible to extend f beyond S ? We shall see in this section that the answer is yes in many cases of interest.³ First consider the following:

equal on a piece, equal
all over

Theorem 12.3.1 *Let $f_1, f_2 : \mathbb{C} \rightarrow \mathbb{C}$ be analytic in a region S . If $f_1 = f_2$ in a neighborhood of a point $z \in S$, or for a segment of a curve in S , then $f_1 = f_2$ for all $z \in S$.*

Proof Let $g = f_1 - f_2$, and $U = \{z \in S \mid g(z) = 0\}$. Then U is a subset of S that includes the neighborhood of z (or the line segment) in which $f_1 = f_2$. If U is the entire region S , we are done. Otherwise, U has a boundary beyond which $g(z) \neq 0$. Since all points within the boundary satisfy $g(z) = 0$, and since g is continuous (more than that, it is analytic) on S , g must vanish also *on* the boundary. But the boundary points are not isolated: Any small circle around any one of them includes points of U as well as points outside U . Thus, g must vanish on a neighborhood of any boundary point, implying that g vanishes for some points outside U . This contradicts our assumption. Thus, U must include the entire region S . \square

A consequence of this theorem is the following corollary.

Corollary 12.3.2 *The behavior of a function that is analytic in a region $S \subset \mathbb{C}$ is completely determined by its behavior in a (small) neighborhood of an arbitrary point in that region.*

This process of determining the behavior of an analytic function outside the region in which it was originally defined is called **analytic continuation**. Although there are infinitely many ways of analytically continuing beyond regions of definition, the values of all functions obtained as a result of diverse continuations are the same at any given point. This follows from Theorem 12.3.1.

Let $f_1, f_2 : \mathbb{C} \rightarrow \mathbb{C}$ be analytic in regions S_1 and S_2 , respectively. Suppose that f_1 and f_2 have different functional forms in their respective regions of analyticity. If there is an overlap between S_1 and S_2 and if $f_1 = f_2$ within that overlap, then the (unique) analytic continuation of f_1 into S_2 must be f_2 , and vice versa. In fact, we may regard f_1 and f_2 as a single

³Provided that S is not discrete (countable). (See [Lang 85, p. 91].)

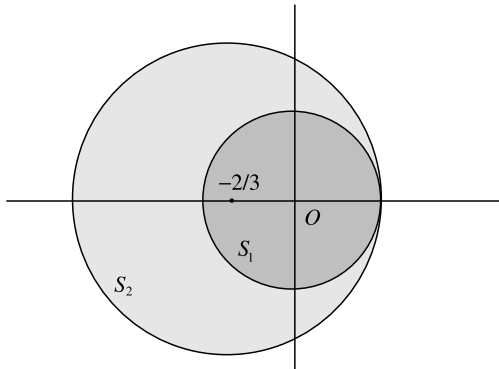

Fig. 12.7 The function defined in the smaller circle is continued analytically into the larger circle

function $f : \mathbb{C} \rightarrow \mathbb{C}$ such that

$$f(z) = \begin{cases} f_1(z) & \text{when } z \in S_1, \\ f_2(z) & \text{when } z \in S_2. \end{cases}$$

Clearly, f is analytic for the combined region $S = S_1 \cup S_2$. We then say that f_1 and f_2 are analytic continuations of one another.

Example 12.3.3 Consider the function $f_1(z) = \sum_{n=0}^{\infty} z^n$, which is analytic for $|z| < 1$. We have seen that it converges to $1/(1-z)$ for $|z| < 1$. Thus, we have $f_1(z) = 1/(1-z)$ when $|z| < 1$, and f_1 is not defined for $|z| > 1$.

Now let us consider a second function,

$$f_2(z) = \sum_{n=0}^{\infty} \left(\frac{3}{5}\right)^{n+1} \left(z + \frac{2}{3}\right)^n,$$

which converges for $|z + \frac{2}{3}| < \frac{5}{3}$. To see what it converges to, we note that

$$f_2(z) = \frac{3}{5} \sum_{n=0}^{\infty} \left[\frac{3}{5} \left(z + \frac{2}{3}\right) \right]^n.$$

Thus,

$$f_2(z) = \frac{\frac{3}{5}}{1 - \frac{3}{5} \left(z + \frac{2}{3}\right)} = \frac{1}{1-z} \quad \text{when } \left|z + \frac{2}{3}\right| < \frac{5}{3}.$$

We observe that although $f_1(z)$ and $f_2(z)$ have different series representations in the two overlapping regions (see Fig. 12.7), they represent the same function, $f(z) = 1/(1-z)$. We can therefore write

$$f(z) = \begin{cases} f_1(z) & \text{when } |z| < 1, \\ f_2(z) & \text{when } |z + \frac{2}{3}| < \frac{5}{3}, \end{cases}$$

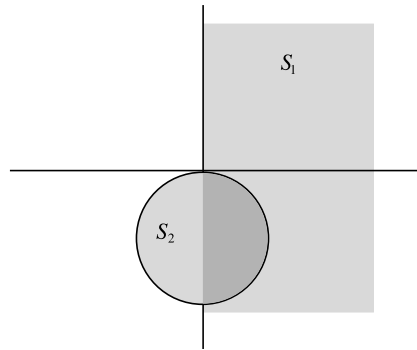

Fig. 12.8 The functions f_1 and f_2 are analytic continuations of each other: f_1 analytically continues f_2 into the *right half-plane*, and f_2 analytically continues f_1 into the semicircle in the *left half-plane*

and f_1 and f_2 are analytic continuations of one another. In fact, $f(z) = 1/(1-z)$ is the analytic continuation of both f_1 and f_2 for all of \mathbb{C} except $z = 1$. Figure 12.7 shows S_i , the region of definition of f_i , for $i = 1, 2$.

Example 12.3.4 The function $f_1(z) = \int_0^\infty e^{-zt} dt$ exists only if $\operatorname{Re}(z) > 0$, in which case $f_1(z) = 1/z$. Its region of definition S_1 is shown in Fig. 12.8 and is simply the right half-plane.

Now we define f_2 by a geometric series: $f_2(z) = i \sum_{n=0}^\infty [(z+i)/i]^n$ where $|z+i| < 1$. This series converges, within its circle of convergence S_2 , to

$$i \frac{1}{1 - (z+i)/i} = \frac{1}{z}.$$

Thus, we have

$$\frac{1}{z} = \begin{cases} f_1(z) & \text{when } z \in S_1, \\ f_2(z) & \text{when } z \in S_2. \end{cases}$$

The two functions are analytic continuations of one another, and $f(z) = 1/z$ is the analytic continuation of both f_1 and f_2 for all $z \in \mathbb{C}$ except $z = 0$.

12.3.1 The Schwarz Reflection Principle

A result that is useful in some physical applications is referred to as a dispersion relation. To derive such a relation we need to know the behavior of analytic functions on either side of the real axis. This is found using the Schwarz reflection principle, for which we need the following result.

Proposition 12.3.5 *Let f_i be analytic throughout S_i , where $i = 1, 2$. Let B be the boundary between S_1 and S_2 (Fig. 12.9) and assume that f_1 and f_2 are continuous on B and coincide there. Then the two functions are analytic*

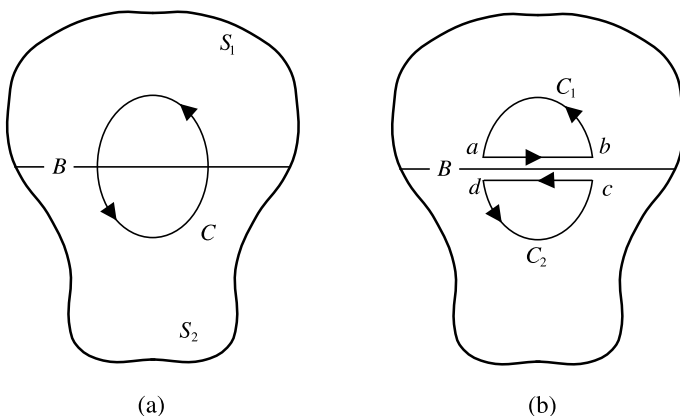

Fig. 12.9 (a) Regions S_1 and S_2 separated by the boundary B and the contour C . (b) The contour C splits up into C_1 and C_2

continuations of one another and together they define a (unique) function

$$f(z) = \begin{cases} f_1(z) & \text{when } z \in S_1 \cup B, \\ f_2(z) & \text{when } z \in S_2 \cup B, \end{cases}$$

which is analytic throughout the entire region $S_1 \cup S_2 \cup B$.

Proof The proof consists of showing that the function integrates to zero along any closed curve in $S_1 \cup S_2 \cup B$. Once this is done, one can use Morera’s theorem to conclude analyticity. The case when the closed curve is entirely in either S_1 or S_2 is trivial. When the curve is partially in S_1 and partially in S_2 the proof becomes only slightly more complicated, because one has to split up the contour C into C_1 and C_2 of Fig. 12.9(b). The details are left as an exercise. \square

Theorem 12.3.6 (Schwarz reflection principle) *Let f be a function that is analytic in a region S that has a segment of the real axis as part of its boundary B . If $f(z)$ is real whenever z is real, then the analytic continuation g of f into S^* (the mirror image of S with respect to the real axis) exists and is given by* Schwarz reflection principle

$$g(z) = (f(z^*))^* \equiv f^*(z^*), \quad \text{where } z \in S^*.$$

Proof First, we show that g is analytic in S^* . Let

$$f(z) \equiv u(x, y) + iv(x, y), \quad g(z) \equiv U(x, y) + iV(x, y).$$

Then $f(z^*) = f(x, -y) = u(x, -y) + iv(x, -y)$ and $g(z) = f^*(z^*)$ imply that $U(x, y) = u(x, -y)$ and $V(x, y) = -v(x, -y)$. Therefore,

$$\frac{\partial U}{\partial x} = \frac{\partial u}{\partial x} = \frac{\partial v}{\partial y} = -\frac{\partial v}{\partial(-y)} = \frac{\partial V}{\partial y},$$

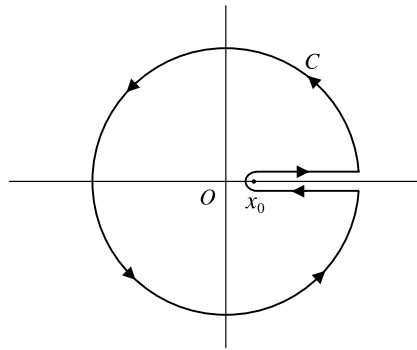

Fig. 12.10 The contour used for dispersion relations

$$\frac{\partial U}{\partial y} = -\frac{\partial u}{\partial y} = \frac{\partial v}{\partial x} = -\frac{\partial V}{\partial x}.$$

These are the Cauchy-Riemann conditions for $g(z)$. Thus, g is analytic.

Next, we note that $f(x, 0) = g(x, 0)$, implying that f and g agree on the real axis. Proposition 12.3.5 then implies that f and g are analytic continuations of one another. \square

It follows from this theorem that there exists an analytic function h such that

$$h(z) = \begin{cases} f(z) & \text{when } z \in S, \\ g(z) & \text{when } z \in S^*. \end{cases}$$

We note that $h(z^*) = g(z^*) = f^*(z) = h^*(z)$.

12.3.2 Dispersion Relations

Let f be analytic throughout the complex plane except at a cut along the real axis extending from x_0 to infinity. For a point z not on the x -axis, the Cauchy integral formula gives $f(z) = (2\pi i)^{-1} \int_C f(\xi) d\xi / (\xi - z)$ where C is the contour shown in Fig. 12.10.

We assume that f drops to zero fast enough that the contribution from the large circle tends to zero. The reader may show that the contribution from the small half-circle around x_0 also vanishes. Then

$$\begin{aligned} f(z) &= \frac{1}{2\pi i} \left[\int_{x_0+i\epsilon}^{\infty+i\epsilon} \frac{f(\xi)}{\xi - z} d\xi - \int_{x_0-i\epsilon}^{\infty-i\epsilon} \frac{f(\xi)}{\xi - z} d\xi \right] \\ &= \frac{1}{2\pi i} \left[\int_{x_0}^{\infty} \frac{f(x+i\epsilon)}{x - z + i\epsilon} dx - \int_{x_0}^{\infty} \frac{f(x-i\epsilon)}{x - z - i\epsilon} dx \right]. \end{aligned}$$

Since z is not on the real axis, we can ignore the $i\epsilon$ terms in the denominators, so that $f(z) = (2\pi i)^{-1} \int_{x_0}^{\infty} [f(x+i\epsilon) - f(x-i\epsilon)] dx / (x - z)$. The Schwarz reflection principle in the form $f^*(z) = f(z^*)$ can now be used to

yield

$$f(x + i\epsilon) - f(x - i\epsilon) = f(x + i\epsilon) - f^*(x + i\epsilon) = 2i \operatorname{Im}[f(x + i\epsilon)].$$

The final result is

$$f(z) = \frac{1}{\pi} \int_{x_0}^{\infty} \frac{\operatorname{Im}[f(x + i\epsilon)]}{x - z} dx.$$

This is one form of a **dispersion relation**. It expresses the value of a function at any point of the cut complex plane in terms of an integral of the imaginary part of the function on the upper edge of the cut. dispersion relation

When there are no residues in the UHP, we can obtain other forms of dispersion relations by equating the real and imaginary parts of Eq. (11.11). The result is

$$\begin{aligned} \operatorname{Re}[f(x_0)] &= \pm \frac{1}{\pi} P \int_{-\infty}^{\infty} \frac{\operatorname{Im}[f(x)]}{x - x_0} dx, \\ \operatorname{Im}[f(x_0)] &= \mp \frac{1}{\pi} P \int_{-\infty}^{\infty} \frac{\operatorname{Re}[f(x)]}{x - x_0} dx, \end{aligned} \tag{12.6}$$

where the upper (lower) sign corresponds to placing the small semicircle around x_0 in the UHP (LHP). The real and imaginary parts of f , as related by Eq. (12.6), are sometimes said to be the **Hilbert transform** of one another. Hilbert transform

In some applications, the imaginary part of f is an odd function of its argument. Then the first equation in (12.6) can be written as

$$\operatorname{Re}[f(x_0)] = \pm \frac{2}{\pi} P \int_0^{\infty} \frac{x \operatorname{Im}[f(x)]}{x^2 - x_0^2} dx.$$

To arrive at dispersion relations, the following condition must hold:

$$\lim_{R \rightarrow \infty} R |f(Re^{i\theta})| = 0,$$

where R is the radius of the large semicircle in the UHP (or LHP). If f does not satisfy this prerequisite, it is still possible to obtain a dispersion relation called a **dispersion relation with one subtraction**. This can be done by introducing an extra factor of x in the denominator of the integrand. We start with Eq. (11.15), confining ourselves to the UHP and assuming that there are no poles there, so that the sum over residues is dropped: dispersion relation with one subtraction

$$\frac{f(x_2) - f(x_1)}{x_2 - x_1} = \frac{1}{i\pi} P \int_{-\infty}^{\infty} \frac{f(x)}{(x - x_1)(x - x_2)} dx.$$

The reader may check that by equating the real and imaginary parts on both sides, letting $x_1 = 0$ and $x_2 = x_0$, and changing x to $-x$ in the first half of the interval of integration, we obtain

$$\begin{aligned} &\frac{\operatorname{Re}[f(x_0)]}{x_0} \\ &= \frac{\operatorname{Re}[f(0)]}{x_0} + \frac{1}{\pi} \left[P \int_0^{\infty} \frac{\operatorname{Im}[f(-x)]}{x(x + x_0)} dx + P \int_0^{\infty} \frac{\operatorname{Im}[f(x)]}{x(x - x_0)} dx \right]. \end{aligned}$$

For the case where $\text{Im}[f(-x)] = -\text{Im}[f(x)]$, this equation yields

$$\text{Re}[f(x_0)] = \text{Re}[f(0)] + \frac{2x_0^2}{\pi} P \int_0^\infty \frac{\text{Im}[f(x)]}{x(x^2 - x_0^2)} dx. \quad (12.7)$$

Example 12.3.7 In optics, it has been shown that the imaginary part of the forward-scattering light amplitude with frequency ω is related, by the so-called **optical theorem**, to the total cross section for the absorption of light of that frequency:

$$\text{Im}[f(\omega)] = \frac{\omega}{4\pi} \sigma_{\text{tot}}(\omega).$$

Substituting this in Eq. (12.7) yields

$$\text{Re}[f(\omega_0)] = \text{Re}[f(0)] + \frac{\omega_0^2}{2\pi^2} P \int_0^\infty \frac{\sigma_{\text{tot}}(\omega)}{\omega^2 - \omega_0^2} d\omega. \quad (12.8)$$

Thus, the real part of the (coherent) forward scattering of light, that is, the real part of the *index of refraction*, can be computed from Eq. (12.8) by either measuring or calculating $\sigma_{\text{tot}}(\omega)$, the simpler quantity describing the absorption of light in the medium. Equation (12.8) is the original **Kramers-Kronig relation**.

12.4 The Gamma and Beta Functions

We have already encountered the gamma function. In this section, we derive some useful relations involving the gamma function and the closely related beta function. The gamma function is a generalization of the factorial function—which is defined only for positive integers—to the system of complex numbers. By differentiating the integral

$$I(\alpha) \equiv \int_0^\infty e^{-\alpha t} dt = 1/\alpha$$

with respect to α repeatedly and setting $\alpha = 1$ at the end, we get $\int_0^\infty t^n e^{-t} dt = n!$. This fact motivates the generalization

$$\Gamma(z) \equiv \int_0^\infty t^{z-1} e^{-t} dt \quad \text{for } \text{Re}(z) > 0, \quad (12.9)$$

where Γ is called the **gamma (or factorial) function**. It is also called *Euler's integral of the second kind*. It is clear from its definition that

$$\Gamma(n+1) = n! \quad (12.10)$$

if n is a positive integer. The restriction $\text{Re}(z) > 0$ assures the convergence of the integral.

An immediate consequence of Eq. (12.9) is obtained by integrating it by parts:

$$\Gamma(z+1) = z\Gamma(z). \quad (12.11)$$

This also leads to Eq. (12.10) by iteration and the fact that $\Gamma(1) = 1$.

Another consequence is the analyticity of $\Gamma(z)$. Differentiating Eq. (12.11) with respect to z , we obtain

$$\frac{d\Gamma(z+1)}{dz} = \Gamma(z) + z \frac{d\Gamma(z)}{dz}.$$

Thus, $d\Gamma(z)/dz$ exists and is finite if and only if $d\Gamma(z+1)/dz$ is finite (recall that $z \neq 0$). The procedure of showing the latter is outlined in Problem 12.16. Therefore, $\Gamma(z)$ is analytic whenever $\Gamma(z+1)$ is. To see the singularities of $\Gamma(z)$, we note that

$$\Gamma(z+n) = z(z+1)(z+2)\cdots(z+n-1)\Gamma(z),$$

or

$$\Gamma(z) = \frac{\Gamma(z+n)}{z(z+1)(z+2)\cdots(z+n-1)}. \quad (12.12)$$

The numerator is analytic as long as $\operatorname{Re}(z+n) > 0$, or $\operatorname{Re}(z) > -n$. Thus, for $\operatorname{Re}(z) > -n$, the singularities of $\Gamma(z)$ are the poles at $z = 0, -1, -2, \dots, -n+1$. Since n is arbitrary, we conclude that

Box 12.4.1 $\Gamma(z)$ is analytic at all $z \in \mathbb{C}$ except at $z = 0, -1, -2, \dots$, where $\Gamma(z)$ has simple poles.

A useful result is obtained by setting $z = \frac{1}{2}$ in Eq. (12.9):

$$\Gamma\left(\frac{1}{2}\right) = \sqrt{\pi}. \quad (12.13)$$

This can be obtained by making the substitution $u = \sqrt{t}$ in the integral.

We can derive an expression for the logarithmic derivative of the gamma function that involves an infinite series. To do so, we use Eq. (12.2) noting that $1/\Gamma(z+1)$ is an entire function with simple zeros at $\{-k\}_{k=1}^{\infty}$. Equation (12.2) gives

$$\frac{1}{\Gamma(z+1)} = e^{\gamma z} \prod_{k=1}^{\infty} \left(1 + \frac{z}{k}\right) e^{-z/k},$$

where γ is a constant to be determined. Using Eq. (12.11), we obtain

$$\frac{1}{\Gamma(z)} = ze^{\gamma z} \prod_{k=1}^{\infty} \left(1 + \frac{z}{k}\right) e^{-z/k}. \quad (12.14)$$

To determine γ , let $z = 1$ in Eq. (12.14) and evaluate the resulting product numerically. The result is $\gamma = 0.57721566\dots$, the so-called **Euler-Mascheroni constant** **Mascheroni constant**.

Differentiating the logarithm of both sides of Eq. (12.14), we obtain

$$\frac{d}{dz} \ln[\Gamma(z)] = -\frac{1}{z} - \gamma + \sum_{k=1}^{\infty} \left(\frac{1}{k} - \frac{1}{z+k} \right). \quad (12.15)$$

Other properties of the gamma function are derivable from the results presented here. Those derivations are left as problems.

The **beta function**, or **Euler's integral of the first kind**, is defined for complex numbers a and b as follows:

$$B(a, b) \equiv \int_0^1 t^{a-1} (1-t)^{b-1} dt \quad \text{where } \operatorname{Re}(a), \operatorname{Re}(b) > 0. \quad (12.16)$$

By changing t to $1/t$, we can also write

$$B(a, b) \equiv \int_1^{\infty} t^{-a-b} (t-1)^{b-1} dt. \quad (12.17)$$

Since $0 \leq t \leq 1$ in Eq. (12.16), we can define θ by $t = \sin^2 \theta$. This gives

$$B(a, b) = 2 \int_0^{\pi/2} \sin^{2a-1} \theta \cos^{2b-1} \theta d\theta. \quad (12.18)$$

This relation can be used to establish a connection between the gamma and beta functions. We note that

$$\Gamma(a) = \int_0^{\infty} t^{a-1} e^{-t} dt = 2 \int_0^{\infty} x^{2a-1} e^{-x^2} dx,$$

where in the last step we changed the variable to $x = \sqrt{t}$. Multiply $\Gamma(a)$ by $\Gamma(b)$ and express the resulting double integral in terms of polar coordinates to obtain $\Gamma(a)\Gamma(b) = \Gamma(a+b)B(a, b)$, or

gamma function and
beta function are related

$$B(a, b) = B(b, a) = \frac{\Gamma(a)\Gamma(b)}{\Gamma(a+b)}. \quad (12.19)$$

Let us now establish the following useful relation:

$$\Gamma(z)\Gamma(1-z) = \frac{\pi}{\sin \pi z}. \quad (12.20)$$

With $a = z$ and $b = 1 - z$, and using $u = \tan \theta$, Eqs. (12.18) and (12.19) give

$$\Gamma(z)\Gamma(1-z) = B(z, 1-z) = 2 \int_0^{\infty} \frac{u^{2z-1}}{u^2+1} du \quad \text{for } 0 < \operatorname{Re}(z) < 1.$$

Using the result obtained in Example 12.2.4, we immediately get Eq. (12.20), valid for $0 < \operatorname{Re}(z) < 1$. By analytic continuation we then generalize Eq. (12.20) to values of z for which both sides are analytic.

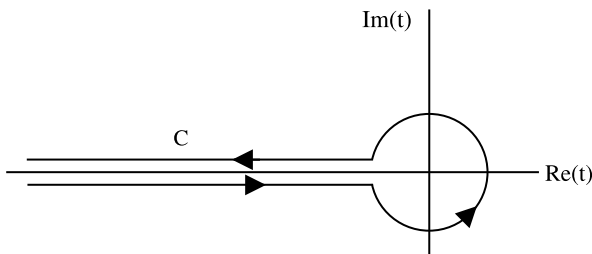

Fig. 12.11 The contour C used in evaluating the reciprocal gamma function

Example 12.4.2 As an illustration of the use of Eq. (12.20), let us show that $\Gamma(z)$ can also be written as

$$\frac{1}{\Gamma(z)} = \frac{1}{2\pi i} \int_C \frac{e^t}{t^z} dt, \tag{12.21}$$

where C is the contour shown in Fig. 12.11. From Eqs. (12.9) and (12.20) it follows that

$$\begin{aligned} \frac{1}{\Gamma(z)} &= \frac{\sin \pi z}{\pi} \Gamma(1-z) = \frac{\sin \pi z}{\pi} \int_0^\infty e^{-r} r^{-z} dr \\ &= \frac{e^{i\pi z} - e^{-i\pi z}}{2\pi i} \int_0^\infty \frac{e^{-r}}{r^z} dr. \end{aligned}$$

The contour integral of Eq. (12.21) can be evaluated by noting that above the real axis, $t = re^{i\pi} = -r$, below it $t = re^{-i\pi} = -r$, and, as the reader may check, that the contribution from the small circle at the origin is zero; so

$$\begin{aligned} \int_C \frac{e^t}{t^z} dt &= \int_0^\infty \frac{e^{-r}}{(re^{i\pi})^z} (-dr) + \int_\infty^0 \frac{e^{-r}}{(re^{-i\pi})^z} (-dr) \\ &= -e^{-i\pi z} \int_0^\infty \frac{e^{-r}}{r^z} dr + e^{i\pi z} \int_0^\infty \frac{e^{-r}}{r^z} dr. \end{aligned}$$

Comparison with the last equation above yields the desired result.

Another useful relation can be obtained by combining Eqs. (12.11) and (12.20):

$$\Gamma(z)\Gamma(1-z) = \Gamma(z)(-z)\Gamma(-z) = \frac{\pi}{\sin \pi z}.$$

Thus,

$$\Gamma(z)\Gamma(-z) = -\frac{\pi}{z \sin \pi z}. \tag{12.22}$$

Once we know $\Gamma(x)$ for positive values of real x , we can use Eq. (12.22) to find $\Gamma(x)$ for $x < 0$. Thus, for instance, $\Gamma(\frac{1}{2}) = \sqrt{\pi}$ gives $\Gamma(-\frac{1}{2}) = -2\sqrt{\pi}$. Equation (12.22) also shows that the gamma function has simple poles wherever z is a negative integer.

12.5 Method of Steepest Descent

It is shown in statistical mechanics ([Hill 87, pp. 150–152]) that the partition function, which generates all the thermodynamical quantities, can be written as a contour integral. Debye found a very elegant technique of approximating this contour integral, which we investigate in this section. Consider the integral

$$I(\alpha) \equiv \int_C e^{\alpha f(z)} g(z) dz \quad (12.23)$$

where $|\alpha|$ is large and f and g are analytic in some region of \mathbb{C} containing the contour C . Since this integral occurs frequently in physical applications, it would be helpful if we could find a general approximation for it that is applicable for all f and g . The fact that $|\alpha|$ is large will be of great help. By redefining $f(z)$, if necessary, we can assume that $\alpha = |\alpha|e^{i \arg(\alpha)}$ is real and positive [absorb $e^{i \arg(\alpha)}$ into the function $f(z)$ if need be].

The exponent of the integrand can be written as

$$\alpha f(z) = \alpha u(x, y) + i\alpha v(x, y).$$

Since α is large and positive, we expect the exponential to be the largest at the maximum of $u(x, y)$. Thus, if we deform the contour so that it passes through a point z_0 at which $u(x, y)$ is maximum, the contribution to the integral may come mostly from the neighborhood of z_0 . This opens up the possibility of expanding the exponent about z_0 and keeping the lowest terms in the expansion, which is what we are after. There is one catch, however. Because of the largeness of α , the imaginary part of αf in the exponent will oscillate violently as $v(x, y)$ changes even by a small amount. This oscillation can make the contribution of the real part of $f(z_0)$ negligibly small and render the whole procedure useless. Thus, we want to tame the variation of $\exp[i\alpha v(x, y)]$ by making $v(x, y)$ vary as slowly as possible. A necessary condition is for the derivative of v to vanish at z_0 . This and the fact that the real part is to have a maximum at z_0 lead to

$$\left. \frac{\partial u}{\partial x} + i \frac{\partial v}{\partial x} = \frac{df}{dz} \right|_{z_0} = 0. \quad (12.24)$$

However, we do not stop here but demand that the imaginary part of f be constant along the deformed contour: $\text{Im}[f(z)] = \text{Im}[f(z_0)]$ or $v(x, y) = v(x_0, y_0)$.

Equation (12.24) and the Cauchy-Riemann conditions imply that $\partial u/\partial x = 0 = \partial u/\partial y$ at z_0 . Thus, it might appear that z_0 is a maximum (or minimum) of the surface described by the function $u(x, y)$. This is not true: For the surface to have a maximum (minimum), both second derivatives, $\partial^2 u/\partial x^2$ and $\partial^2 u/\partial y^2$, must be negative (positive). But that is impossible because $u(x, y)$ is harmonic—the sum of these two derivatives is zero. Recall that a point at which the derivatives vanish but that is neither a maximum nor a minimum is called a *saddle point*. That is why the procedure described below is sometimes called the **saddle point approximation**.

saddle point
approximation

We are interested in values of z close to z_0 . So let us expand $f(z)$ in a Taylor series about z_0 , use Eq. (12.24), and keep terms only up to the second, to obtain

$$f(z) = f(z_0) + \frac{1}{2}(z - z_0)^2 f''(z_0). \quad (12.25)$$

Let us assume that $f''(z_0) \neq 0$, and define

$$z - z_0 = r_1 e^{i\theta_1} \quad \text{and} \quad \frac{1}{2} f''(z_0) = r_2 e^{i\theta_2} \quad (12.26)$$

and substitute in the above expansion to obtain

$$f(z) - f(z_0) = r_1^2 r_2 e^{i(2\theta_1 + \theta_2)}, \quad (12.27)$$

or

$$\begin{aligned} \operatorname{Re}[f(z) - f(z_0)] &= r_1^2 r_2 \cos(2\theta_1 + \theta_2), \\ \operatorname{Im}[f(z) - f(z_0)] &= r_1^2 r_2 \sin(2\theta_1 + \theta_2). \end{aligned} \quad (12.28)$$

The constancy of $\operatorname{Im}[f(z)]$ implies that $\sin(2\theta_1 + \theta_2) = 0$, or $2\theta_1 + \theta_2 = n\pi$. Thus, for $\theta_1 = -\theta_2/2 + n\pi/2$ where $n = 0, 1, 2, 3$, the imaginary part of f is constant. The angle θ_2 is determined by the second equation in (12.26). Once we determine n , the path of saddle point integration will be specified.

To get insight into this specification, consider $z - z_0 = r_1 e^{i(-\theta_2/2 + n\pi/2)}$, and eliminate r_1 from its real and imaginary parts to obtain

$$y - y_0 = \left[\tan\left(\frac{n\pi}{2} - \frac{\theta_2}{2}\right) \right] (x - x_0).$$

This is the equation of a line passing through $z_0 = (x_0, y_0)$ and making an angle of $\theta_1 = (n\pi - \theta_2)/2$ with the real axis. For $n = 0, 2$ we get one line, and for $n = 1, 3$ we get another that is perpendicular to the first (see Fig. 12.12). It is to be emphasized that along both these lines the imaginary part of $f(z)$ remains constant. To choose the correct line, we need to look at the real part of the function. Also note that these “lines” are small segments of (or tangents to) the deformed contour at z_0 .

We are looking for directions along which $\operatorname{Re}(f)$ goes through a relative maximum at z_0 . In fact, we are after a path on which the function decreases maximally. This occurs when $\operatorname{Re}[f(z)] - \operatorname{Re}[f(z_0)]$ take the largest negative value. Equation (12.28) determines such a path: It is that path on which $\cos(2\theta_1 + \theta_2) = -1$, or when $n = 1, 3$. There is only one such path in the region of interest, and the procedure is uniquely determined.⁴ Because the descent from the maximum value at z_0 is maximum along such a path, this procedure is called the method of **steepest descent**.

method of steepest descent

⁴The angle θ_1 is still ambiguous by π , because n can be 1 or 3. However, by a suitable sign convention described below, we can remove this ambiguity.

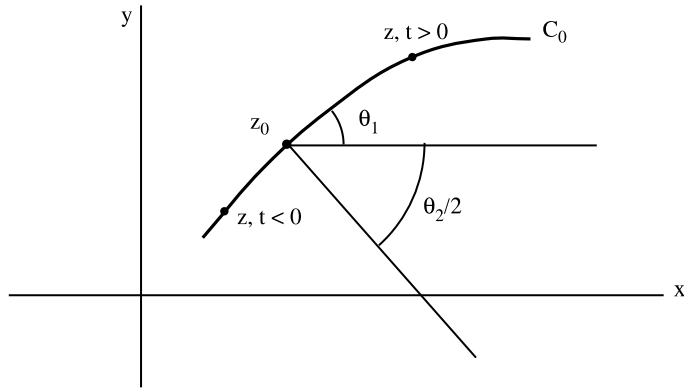

Fig. 12.12 A segment of the contour C_0 in the vicinity of z_0 . The lines mentioned in the text are small segments of the contour C_0 centered at z_0

Now that we have determined the contour, let us approximate the integral. Substituting $2\theta_1 + \theta_2 = \pi, 3\pi$ in Eq. (12.27), we get

$$f(z) - f(z_0) = -r_1^2 r_2 \equiv -t^2 = \frac{1}{2}(z - z_0)^2 f''(z_0). \quad (12.29)$$

Using this in Eq. (12.23) yields

$$I(\alpha) \approx \int_{C_0} e^{\alpha[f(z_0) - t^2]} g(z) dz = e^{\alpha f(z_0)} \int_{C_0} e^{-\alpha t^2} g(z) dz, \quad (12.30)$$

where C_0 is the deformed contour passing through z_0 .

To proceed, we need to solve for z in terms of t . From Eq. (12.29) we have

$$(z - z_0)^2 = -\frac{2}{f''(z_0)} t^2 = -\frac{t^2}{r_2} e^{-i\theta_2}.$$

Therefore, $|z - z_0| = |t|/\sqrt{r_2}$, or $z - z_0 = (|t|/\sqrt{r_2})e^{i\theta_1}$, by the first equation of (12.26). Let us agree that for $t > 0$, the point z on the contour will move in the direction that makes an angle of $0 \leq \theta_1 < \pi$, and that $t < 0$ corresponds to the opposite direction. This convention removes the remaining ambiguity of the angle θ_1 , and gives

$$z = z_0 + \frac{t}{\sqrt{r_2}} e^{i\theta_1}, \quad 0 \leq \theta_1 < \pi. \quad (12.31)$$

Using the Taylor expansion of $g(z)$ about z_0 , we can write

$$\begin{aligned} g(z) dz &= \left\{ \sum_{n=0}^{\infty} \frac{t^n}{r_2^{n/2} n!} e^{in\theta_1} g^{(n)}(z_0) \right\} \frac{e^{i\theta_1}}{\sqrt{r_2}} dt \\ &= \sum_{n=0}^{\infty} \frac{t^n}{r_2^{(n+1)/2} n!} e^{i(n+1)\theta_1} g^{(n)}(z_0) dt, \end{aligned}$$

and substituting this in Eq. (12.30) yields

$$\begin{aligned} I(\alpha) &\approx e^{\alpha f(z_0)} \int_{C_0} e^{-\alpha t^2} \left\{ \sum_{n=0}^{\infty} \frac{t^n}{r_2^{(n+1)/2} n!} e^{i(n+1)\theta_1} g^{(n)}(z_0) \right\} dt \\ &= e^{\alpha f(z_0)} \sum_{n=0}^{\infty} \frac{e^{i(n+1)\theta_1}}{r_2^{(n+1)/2} n!} g^{(n)}(z_0) \int_{-\infty}^{\infty} e^{-\alpha t^2} t^n dt. \end{aligned} \quad (12.32)$$

The extension of the integral limits to infinity does not alter the result significantly because α is assumed large and positive. The integral in the sum is zero for odd n . When n is even, we make the substitution $u = \alpha t^2$ and show that

$$\int_{-\infty}^{\infty} e^{-\alpha t^2} t^n dt = \alpha^{-(n+1)/2} \Gamma[(n+1)/2].$$

With $n = 2k$, and using $r_2 = |f''(z_0)|/2$, the sum becomes

$$I(\alpha) \approx e^{\alpha f(z_0)} \sum_{k=0}^{\infty} \frac{2^{k+1/2} e^{i(2k+1)\theta_1}}{|f''(z_0)|^{k+1/2} (2k)!} g^{(2k)}(z_0) \Gamma\left(k + \frac{1}{2}\right) \alpha^{-k-1/2}. \quad (12.33)$$

This is called the **asymptotic expansion** of $I(\alpha)$. In most applications, only the first term of the above series is retained, giving asymptotic expansion
of $I(\alpha)$

$$I(\alpha) \approx e^{\alpha f(z_0)} \sqrt{\frac{2\pi}{\alpha}} \frac{e^{i\theta_1} g(z_0)}{\sqrt{|f''(z_0)|}}. \quad (12.34)$$

Example 12.5.1 Let us approximate the integral

$$I(\alpha) \equiv \Gamma(\alpha + 1) = \int_0^{\infty} e^{-z} z^\alpha dz,$$

where α is a positive real number. First, we must rewrite the integral in the form of Eq. (12.23). We can do this by noting that $z^\alpha = e^{\alpha \ln z}$. Thus, we have

$$I(\alpha) = \int_0^{\infty} e^{\alpha \ln z - z} dz = \int_0^{\infty} e^{\alpha(\ln z - z/\alpha)} dz,$$

and we identify $f(z) = \ln z - z/\alpha$ and $g(z) = 1$. The saddle point is found from $f'(z) = 0$ or $z_0 = \alpha$. Furthermore, from

$$\frac{1}{2} f''(z_0) = \frac{1}{2} \left(-\frac{1}{\alpha^2} \right) = \frac{1}{2\alpha^2} e^{i\pi} \Rightarrow \theta_2 = \pi$$

and $2\theta_1 + \theta_2 = \pi, 3\pi$, as well as the condition $0 \leq \theta_1 < \pi$, we conclude that $\theta_1 = 0$.

Substitution in Eq. (12.34) yields

$$\begin{aligned} \Gamma(\alpha + 1) &\approx e^{\alpha f(z_0)} \sqrt{\frac{2\pi}{\alpha}} \frac{1}{\sqrt{|1/\alpha^2|}} \\ &= \sqrt{2\pi} \alpha e^{\alpha(\ln \alpha - 1)} = \sqrt{2\pi} e^{-\alpha} \alpha^{\alpha+1/2}, \end{aligned} \quad (12.35)$$

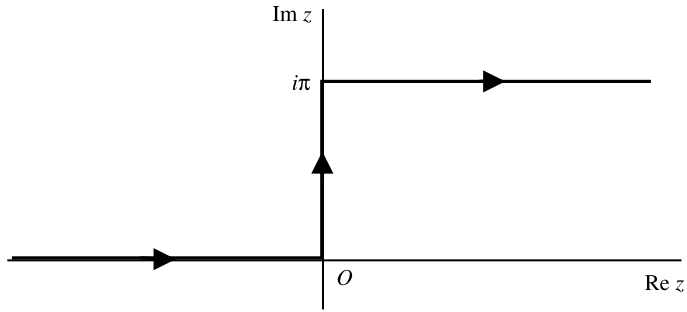

Fig. 12.13 The contour for the evaluation of the Hankel function of the first kind

Stirling approximation which is called the **Stirling approximation**. For $\alpha = n$, a positive integer, this yields the useful result

$$n! \approx \sqrt{2\pi} e^{-n} n^{n+1/2}$$

with the approximation getting better and better for larger and larger n .

Hankel function of the first kind **Example 12.5.2** The *Hankel function of the first kind* is defined as

$$H_v^{(1)}(\alpha) \equiv \frac{1}{i\pi} \int_C e^{(\alpha/2)(z-1/z)} \frac{dz}{z^{\nu+1}},$$

where C is the contour shown in Fig. 12.13.

We want to find the asymptotic expansion of this function, choosing the branch of the function in which $-\pi < \theta < \pi$.

We identify $f(z) = \frac{1}{2}(z - 1/z)$ and $g(z) = z^{-\nu-1}$. Next, the stationary points of f are calculated:

$$\frac{df}{dz} = \frac{1}{2} + \frac{1}{2z^2} = 0 \Rightarrow z_0 = \pm i.$$

The contour of integration suggests the saddle point $z_0 = +i$. The second derivative evaluated at the saddle point gives $f''(z_0) = -1/z_0^3 = -i = e^{-i\pi/2}$, or $\theta_2 = -\pi/2$. This, and the convention $0 \leq \theta_1 < \pi$, force us to choose $\theta_1 = 3\pi/4$. Substituting this in Eq. (12.34) and noting that $f(i) = i$ and $|f''(z_0)| = 1$, we obtain

$$H_v^{(1)}(\alpha) \equiv \frac{1}{i\pi} I(\alpha) \approx \frac{1}{i\pi} e^{\alpha i} \sqrt{\frac{2\pi}{\alpha}} e^{i3\pi/4} i^{-\nu-1} = \sqrt{\frac{2}{\alpha\pi}} e^{i(\alpha-\nu\pi/2-\pi/4)},$$

where we have used $i^{-\nu-1} = e^{-i(\nu+1)\pi/2}$.

Although Eq. (12.34) is adequate for most applications, we shall have occasions to demand a better approximation. One may try to keep higher-order terms of Eq. (12.33), but that infinite sum is in reality inconsistent. The reason is that in the product $g(z) dz$, we kept only the first power of t in the expansion of z . To restore consistency, let us expand $z(t)$ as well.

Suppose

$$z - z_0 = \sum_{m=1}^{\infty} b_m t^m \Rightarrow dz = \sum_{m=0}^{\infty} (m+1)b_{m+1} t^m dt,$$

so that

$$\begin{aligned} g(z) dz &= \sum_{n=0}^{\infty} \frac{t^n}{r_2^{n/2} n!} e^{in\theta_1} g^{(n)}(z_0) \sum_{m=0}^{\infty} (m+1)b_{m+1} t^m dt \\ &= \sum_{m,n=0}^{\infty} \frac{e^{in\theta_1}}{r_2^{n/2} n!} (m+1)b_{m+1} g^{(n)}(z_0) t^{m+n} dt. \end{aligned}$$

Now introduce $l = m + n$ and note that the summation over n goes up to l . This gives

$$g(z) dz = \sum_{l=0}^{\infty} \underbrace{\sum_{n=0}^l \frac{e^{in\theta_1}}{r_2^{n/2} n!} (l-n+1)b_{l-n+1} g^{(n)}(z_0)}_{\equiv a_l} t^l dt = \sum_{l=0}^{\infty} a_l t^l dt.$$

Substituting this in Eq. (12.30) and changing the contour integration into the integral from $-\infty$ to ∞ as before yields

$$\begin{aligned} I(\alpha) &\approx e^{\alpha f(z_0)} \sum_{k=0}^{\infty} a_{2k} \alpha^{-k-1/2} \Gamma\left(k + \frac{1}{2}\right), \\ a_{2k} &= \sum_{n=0}^{2k} \frac{e^{in\theta_1}}{r_2^{n/2} n!} (2k-n+1)b_{2k-n+1} g^{(n)}(z_0). \end{aligned} \tag{12.36}$$

The only thing left to do is to evaluate b_m . We shall not give a general formula for these coefficients. Instead, we shall calculate the first three of them. This should reveal to the reader the general method of approximating them to any order. We have already calculated b_1 in Eq. (12.31). To calculate b_2 , keep the next-highest term in the expansion of both z and t^2 . Thus write

$$z - z_0 = b_1 t + b_2 t^2, \quad t^2 = -\frac{1}{2} f''(z_0)(z - z_0)^2 - \frac{1}{6} f'''(z_0)(z - z_0)^3.$$

Now substitute the first equation in the second and equate the coefficients of equal powers of t on both sides. The second power of t gives nothing new: It merely reaffirms the value of b_1 . The coefficient of the third power of t is $-b_1 b_2 f''(z_0) - \frac{1}{6} b_1^3 f'''(z_0)$. Setting this equal to zero gives

$$b_2 = -\frac{b_1^2 f'''(z_0)}{6 f''(z_0)} = \frac{f'''(z_0)}{3 |f''(z_0)|^2} e^{4i\theta_1}, \tag{12.37}$$

where we substituted for b_1 from Eq. (12.31) and used $2\theta_1 + \theta_2 = \pi$.

To calculate b_3 , keep one more term in the expansion of both z and t^2 to obtain

$$z - z_0 = b_1 t + b_2 t^2 + b_3 t^3$$

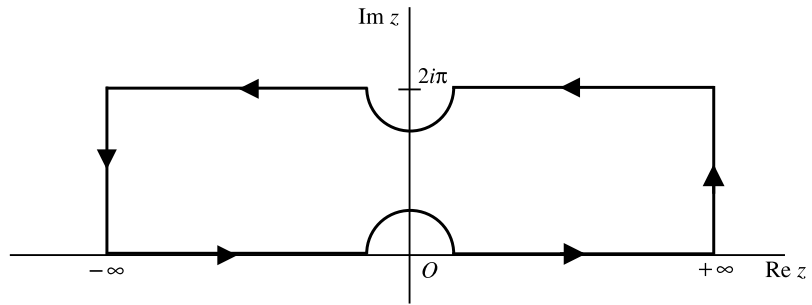

Fig. 12.14 Contour used for Problem 12.4

and

$$t^2 = -\frac{1}{2}f''(z_0)(z - z_0)^2 - \frac{1}{6}f'''(z_0)(z - z_0)^3 - \frac{1}{24}f^{(iv)}(z_0)(z - z_0)^4.$$

Once again substitute the first equation in the second and equate the coefficients of equal powers of t on both sides. The second and third powers of t give nothing new. Setting the coefficient of the fourth power of t equal to zero yields

$$\begin{aligned} b_3 &= b_1^3 \left\{ \frac{5[f'''(z_0)]^2}{72[f''(z_0)]^2} - \frac{f^{(iv)}}{24f''(z_0)} \right\} \\ &= \frac{\sqrt{2}e^{3i\theta_1}}{12|f''(z_0)|^{3/2}} \left\{ \frac{5[f'''(z_0)]^2}{3[f''(z_0)]^2} - \frac{f^{(iv)}}{f''(z_0)} \right\}. \end{aligned} \quad (12.38)$$

12.6 Problems

12.1 Derive Eq. (12.2) from its logarithmic derivative.

12.2 Show that the point at infinity is not a branch point for $f(z) = (z^2 - 1)^{1/2}$.

12.3 Find the following integrals, for which $0 \neq a \in \mathbb{R}$.

$$\begin{aligned} \text{(a)} \quad & \int_0^\infty \frac{\ln x}{(x^2 + a^2)^2} dx, & \text{(b)} \quad & \int_0^\infty \frac{\ln x}{(x^2 + a^2)^2 \sqrt{x}} dx, \\ \text{(c)} \quad & \int_0^\infty \frac{(\ln x)^2}{x^2 + a^2} dx. \end{aligned}$$

12.4 Use the contour in Fig. 12.14 to evaluate the following integrals.

$$\text{(a)} \quad \int_0^\infty \frac{\sin ax}{\sinh x} dx, \quad \text{(b)} \quad \int_0^\infty \frac{x \cos ax}{\sinh x} dx.$$

12.5 Show that $\int_0^\pi f(\sin \theta) d\theta = 2 \int_0^{\pi/2} f(\sin \theta) d\theta$ for an arbitrary function f defined in the interval $[-1, +1]$.

12.6 Find the principal value of the integral $\int_{-\infty}^{\infty} x \sin x dx / (x^2 - x_0^2)$ and evaluate

$$I = \int_{-\infty}^{\infty} \frac{x \sin x}{(x - x_0 \pm i\epsilon)(x + x_0 \pm i\epsilon)} dx$$

for the four possible choices of signs.

12.7 Use analytic continuation, the analyticity of the exponential, hyperbolic, and trigonometric functions, and the analogous identities for real z to prove the following identities.

$$\begin{aligned} \text{(a)} \quad e^z &= \cosh z + \sinh z, & \text{(b)} \quad \cosh^2 z - \sinh^2 z &= 1, \\ \text{(c)} \quad \sin 2z &= 2 \sin z \cos z. \end{aligned}$$

12.8 Show that the function $1/z^2$ represents the analytic continuation into the domain $\mathbb{C} - \{0\}$ (all the complex plane minus the origin) of the function defined by $\sum_{n=0}^{\infty} (n+1)(z+1)^n$ where $|z+1| < 1$.

12.9 Find the analytic continuation into $\mathbb{C} - \{i, -i\}$ (all the complex plane except i and $-i$) of $f(z) = \int_0^{\infty} e^{-zt} \sin t dt$ where $\operatorname{Re}(z) > 0$.

12.10 Expand $f(z) = \sum_{n=0}^{\infty} z^n$ (defined in its circle of convergence) in a Taylor series about $z = a$. For what values of a does this expansion permit the function $f(z)$ to be continued analytically?

12.11 The two power series

$$f_1(z) = \sum_{n=1}^{\infty} \frac{z^n}{n} \quad \text{and} \quad f_2(z) = i\pi + \sum_{n=1}^{\infty} (-1)^n \frac{(z-2)^n}{n}$$

have no common domain of convergence. Show that they are nevertheless analytic continuations of one another.

12.12 Prove that the functions defined by the two series

$$1 + az + a^2 z^2 + \dots \quad \text{and} \quad \frac{1}{1-z} - \frac{(1-a)z}{(1-z)^2} + \frac{(1-a)^2 z^2}{(1-z)^3} - \dots$$

are analytic continuations of one another.

12.13 Show that the function $f_1(z) = 1/(z^2 + 1)$, where $z \neq \pm i$, is the analytic continuation into $\mathbb{C} - \{i, -i\}$ of the function $f_2(z) = \sum_{n=0}^{\infty} (-1)^n z^{2n}$, where $|z| < 1$.

12.14 Find the analytic continuation into $\mathbb{C} - \{0\}$ of the function

$$f(z) = \int_0^{\infty} t e^{-zt} dt \quad \text{where } \operatorname{Re}(z) > 0.$$

12.15 Show that the integral in Eq. (12.9) converges. Hint: First show that $|\Gamma(z+1)| \leq \int_0^\infty t^x e^{-t} dt$ where $x = \operatorname{Re}(z)$. Now show that

$$\int_0^\infty t^x e^{-t} dt \leq \int_0^1 t^x e^{-t} dt + \int_0^\infty t^n e^{-t} dt \quad \text{for some integer } n > 0$$

and conclude that $\Gamma(z)$ is finite.

12.16 Show that $d\Gamma(z+1)/dz$ exists and is finite by establishing the following:

- $|\ln t| < t + 1/t$ for $t > 0$. Hint: For $t \geq 1$, show that $t - \ln t$ is a monotonically increasing function. For $t < 1$, make the substitution $t = 1/s$.
- Use the result from part (a) in the integral for $d\Gamma(z+1)/dz$ to show that $|d\Gamma(z+1)/dz|$ is finite. Hint: Differentiate inside the integral.

12.17 Derive Eq. (12.11) from Eq. (12.9).

12.18 Show that $\Gamma(\frac{1}{2}) = \sqrt{\pi}$, and that

$$(2k-1)!! \equiv (2k-1)(2k-3)\cdots 5 \cdot 3 \cdot 1 = \frac{2^k}{\sqrt{\pi}} \Gamma\left(\frac{2k+1}{2}\right).$$

12.19 Show that $\Gamma(z) = \int_0^1 [\ln(1/t)]^{z-1} dt$ with $\operatorname{Re}(z) > 0$.

12.20 Derive the identity $\int_0^\infty e^{-x^\alpha} dx = \Gamma[(\alpha+1)/\alpha]$.

12.21 Consider the function $f(z) = (1+z)^\alpha$.

- Show that $d^n f/dz^n|_{z=0} = \Gamma(\alpha+1)/\Gamma(\alpha-n+1)$, and use it to derive the relation

$$(1+z)^\alpha = \sum_{n=0}^{\infty} \binom{\alpha}{n} z^n, \quad \text{where}$$

$$\binom{\alpha}{n} \equiv \frac{\alpha!}{n!(\alpha-n)!} \equiv \frac{\Gamma(\alpha+1)}{n!\Gamma(\alpha-n+1)}.$$

- Show that for general complex numbers a and b we can formally write

$$(a+b)^\alpha = \sum_{n=0}^{\infty} \binom{\alpha}{n} a^n b^{\alpha-n}.$$

- Show that if α is a positive integer m , the series in part (b) truncates at $n = m$.

12.22 Prove that the residue of $\Gamma(z)$ at $z = -k$ is $r_k = (-1)^k/k!$. Hint: Use Eq. (12.12)

12.23 Derive the following relation for $z = x + iy$:

$$|\Gamma(z)| = \Gamma(x) \prod_{k=0}^{\infty} \left[1 + \frac{y^2}{(x+k)^2} \right]^{-1/2}.$$

12.24 Using the definition of $B(a, b)$, Eq. (12.16), show that $B(a, b) = B(b, a)$.

12.25 Integrate Eq. (12.21) by parts and derive Eq. (12.11).

12.26 For positive integers n , show that $\Gamma(\frac{1}{2} - n)\Gamma(\frac{1}{2} + n) = (-1)^n \pi$.

12.27 Show that

- (a) $B(a, b) = B(a+1, b) + B(a, b+1)$.
 (b) $B(a, b+1) = (\frac{b}{a+b})B(a, b)$.
 (c) $B(a, b)B(a+b, c) = B(b, c)B(a, b+c)$.

12.28 Verify that $\int_{-1}^1 (1+t)^a (1-t)^b dt = 2^{a+b+1} B(a+1, b+1)$.

12.29 Show that the volume of the solid formed by the surface $z = x^a y^b$, the xy -, yz -, and xz -planes, and the plane parallel to the z -axis and going through the points $(0, y_0)$ and $(x_0, 0)$ is

$$\frac{x_0^{a+1} y_0^{b+1}}{a+b+2} B(a+1, b+1).$$

12.30 Derive this relation:

$$\int_0^{\infty} \frac{\sinh^a x}{\cosh^b x} dx = \frac{1}{2} B\left(\frac{a+1}{2}, \frac{b-a}{2}\right) \quad \text{where } -1 < a < b.$$

Hint: Let $t = \tanh^2 x$ in Eq. (12.16).

12.31 The *Hankel function of the second kind* is defined as

Hankel function of the second kind

$$H_\nu^{(2)}(\alpha) \equiv \frac{1}{i\pi} \int_C e^{(\alpha/2)(z-1/z)} \frac{dz}{z^{\nu+1}},$$

where C is the contour shown in Fig. 12.15.

Find the asymptotic expansion of this function.

12.32 Find the asymptotic dependence of the *modified Bessel function of the first kind*, defined as

modified Bessel function of the first kind

$$I_\nu(\alpha) \equiv \frac{1}{2\pi i} \oint_C e^{(\alpha/2)(z+1/z)} \frac{dz}{z^{\nu+1}},$$

where C starts at $-\infty$, approaches the origin and circles it, and goes back to $-\infty$. Thus the negative real axis is excluded from the domain of analyticity.

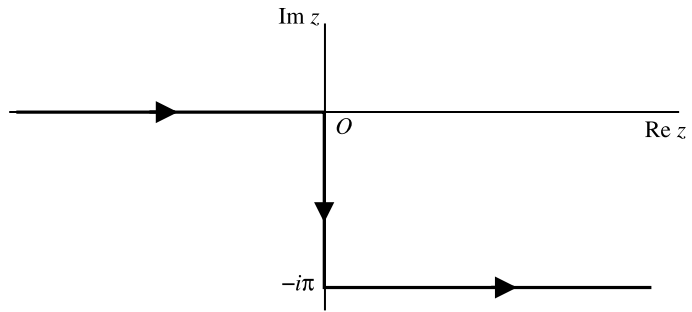

Fig. 12.15 The contour for the evaluation of the Hankel function of the second kind

modified Bessel function of the second kind

12.33 Find the asymptotic dependence of the *modified Bessel function of the second kind*:

$$K_\nu(\alpha) \equiv \frac{1}{2} \int_C e^{-(\alpha/2)(z+1/z)} \frac{dz}{z^{\nu+1}},$$

where C starts at ∞ , approaches the origin and circles it, and goes back to ∞ . Thus the positive real axis is excluded from the domain of analyticity.

Part IV
Differential Equations

The laws of physics are almost exclusively written in the form of differential equations (DEs). In (point) particle mechanics there is only one independent variable, leading to ordinary differential equations (ODEs). In other areas of physics in which extended objects such as fields are studied, variations with respect to position are also important. Partial derivatives with respect to coordinate variables show up in the differential equations, which are therefore called partial differential equations (PDEs). We list the most common PDEs of mathematical physics in the following.

13.1 PDEs of Mathematical Physics

In electrostatics, where time-independent scalar fields, such as potentials, and vector fields such as electrostatic fields, are studied, the law is described by **Poisson's equation**,

Poisson's equation

$$\nabla^2 \Phi(\mathbf{r}) = -4\pi\rho(\mathbf{r}). \quad (13.1)$$

In vacuum, where $\rho(\mathbf{r}) = 0$, Eq. (13.1) reduces to **Laplace's equation**,

Laplace's equation

$$\nabla^2 \Phi(\mathbf{r}) = 0. \quad (13.2)$$

Many electrostatic problems involve conductors held at constant potentials and situated in vacuum. In the space between such conducting surfaces, the electrostatic potential obeys Eq. (13.2).

The most simplified version of the **heat equation** is

heat equation

$$\frac{\partial T}{\partial t} = a^2 \nabla^2 T(\mathbf{r}), \quad (13.3)$$

where T is the temperature and a is a constant characterizing the medium in which heat flows.

One of the most frequently recurring PDEs encountered in mathematical physics is the **wave equation**,

wave equation

$$\nabla^2 \Psi - \frac{1}{c^2} \frac{\partial^2 \Psi}{\partial t^2} = 0. \quad (13.4)$$

This equation (or its simplification to lower dimensions) is applied to the vibration of strings and drums; the propagation of sound in gases, solids, and liquids; the propagation of disturbances in plasmas; and the propagation of electromagnetic waves.

Schrödinger equation The **Schrödinger equation**, describing nonrelativistic quantum phenomena, is

$$-\frac{\hbar^2}{2m}\nabla^2\Psi + V(\mathbf{r})\Psi = i\hbar\frac{\partial\Psi}{\partial t}, \quad (13.5)$$

where m is the mass of a subatomic particle, \hbar is Planck's constant (divided by 2π), V is the potential energy of the particle, and $|\Psi(\mathbf{r}, t)|^2$ is the probability density of finding the particle at \mathbf{r} at time t .

Klein-Gordon equation A relativistic generalization of the Schrödinger equation for a free particle of mass m is the **Klein-Gordon equation**, which, in terms of the natural units ($\hbar = 1 = c$), reduces to

$$\nabla^2\phi - m^2\phi = \frac{\partial^2\phi}{\partial t^2}. \quad (13.6)$$

Equations (13.3)–(13.6) have partial derivatives with respect to time. As a first step toward solving these PDEs and as an introduction to similar techniques used in the solution of PDEs not involving time,¹ let us separate the time variable. We will denote the functions in all four equations by the generic symbol $\Psi(\mathbf{r}, t)$. The basic idea is to separate the \mathbf{r} and t dependence into factors: $\Psi(\mathbf{r}, t) \equiv R(\mathbf{r})T(t)$. This factorization permits us to separate the two operations of space differentiation and time differentiation. Let \mathbf{S} stand for all spatial derivative operators and write all the relevant equations either as $\mathbf{S}\Psi = \partial\Psi/\partial t$ or as $\mathbf{S}\Psi = \partial^2\Psi/\partial t^2$. With this notation and the above separation, we have

$$\mathbf{S}(RT) = T(\mathbf{S}R) = \begin{cases} RdT/dt, \\ Rd^2T/dt^2. \end{cases}$$

Dividing both sides by RT , we obtain

$$\frac{1}{R}\mathbf{S}R = \begin{cases} \frac{1}{T}\frac{dT}{dt}, \\ \frac{1}{T}\frac{d^2T}{dt^2}. \end{cases} \quad (13.7)$$

Now comes the crucial step in the process of separation of variables. The LHS of Eq. (13.7) is a function of *position alone*, and the RHS is a function of *time alone*. Since \mathbf{r} and t are independent variables, the only way that (13.7) can hold is for *both sides to be constant*, say α :

$$\frac{1}{R}\mathbf{S}R = \alpha \quad \Rightarrow \quad \mathbf{S}R = \alpha R$$

¹See [Hass 08] for a thorough discussion of separation in Cartesian and cylindrical coordinates. Chapter 19 of this book also contains examples of solutions to some second-order linear DEs resulting from such separation.

and²

$$\frac{1}{T} \frac{dT}{dt} = \alpha \Rightarrow \frac{dT}{dt} = \alpha T \quad \text{or} \quad \frac{1}{T} \frac{d^2T}{dt^2} = \alpha \Rightarrow \frac{d^2T}{dt^2} = \alpha T.$$

We have reduced the original time-dependent PDE to an ODE,

$$\frac{dT}{dt} = \alpha T \quad \text{or} \quad \frac{d^2T}{dt^2} = \alpha T, \quad (13.8)$$

and a PDE involving only the position variables, $(\mathbf{S} - \alpha)R = 0$. The most general form of $\mathbf{S} - \alpha$ arising from Eqs. (13.3) through (13.6) is $\mathbf{S} - \alpha \equiv \nabla^2 + f(\mathbf{r})$. Therefore, Eqs. (13.3)–(13.6) are equivalent to (13.8), and $\nabla^2 R + f(\mathbf{r})R = 0$, which we rewrite as

$$\nabla^2 \Psi(\mathbf{r}) + f(\mathbf{r})\Psi(\mathbf{r}) = 0. \quad (13.9)$$

This is called a *homogeneous* PDE because of the zero on the right-hand side. Of all the PDEs outlined above, Poisson's equation is the only inhomogeneous equation. We will restrict ourselves to the homogeneous case in this chapter.

Depending on the geometry of the problem, Eq. (13.9) is further separated into ODEs each involving a single coordinate of a suitable coordinate system. We shall see examples of all major coordinate systems (Cartesian, cylindrical, and spherical) in Chap. 19. For the rest of this chapter, we shall concentrate on some general aspects of the spherical coordinates.

Historical Notes

Jean Le Rond d'Alembert (1717–1783) was the illegitimate son of a famous salon hostess of eighteenth-century Paris and a cavalry officer. Abandoned by his mother, d'Alembert was raised by a foster family and later educated by the arrangement of his father at a nearby church-sponsored school, in which he received instruction in the classics and above-average instruction in mathematics. After studying law and medicine, he finally chose to pursue a career in mathematics. In the 1740s he joined the ranks of the *philosophes*, a growing group of deistic and materialistic thinkers and writers who actively questioned the social and intellectual standards of the day. He traveled little (he left France only once, to visit the court of Frederick the Great), preferring instead the company of his friends in the salons, among whom he was well known for his wit and laughter.

D'Alembert turned his mathematical and philosophical talents to many of the outstanding scientific problems of the day, with mixed success. Perhaps his most famous scientific work, entitled *Traité de dynamique*, shows his appreciation that a revolution was taking place in the science of mechanics—the formalization of the principles stated by Newton into a rigorous mathematical framework. The philosophy to which d'Alembert subscribed, however, refused to acknowledge the primacy of a concept as unclear and arbitrary as “force,” introducing a certain awkwardness to his treatment and perhaps causing him to overlook the important principle of conservation of energy. Later, d'Alembert produced a treatise on fluid mechanics (the priority of which is still debated by historians), a paper dealing with vibrating strings (in which the wave equation makes its first appearance in physics), and a skillful treatment of celestial mechanics. D'Alembert is also credited with use of the first partial differential equation as well as the first solution



Jean Le Rond d'Alembert
1717–1783

²In most cases, α is chosen to be real. In the case of the Schrödinger equation, it is more convenient to choose α to be purely imaginary so that the i in the definition of \mathbf{S} can be compensated. In all cases, the precise nature of α is determined by boundary conditions.

to such an equation using **separation of variables**. (One should be careful interpreting “first”: many of d’Alembert’s predecessors and contemporaries gave similar, though less satisfactory, treatments of these milestones.) Perhaps his most well-known contribution to mathematics (at least among students) is the ratio test for the convergence of infinite series.

Much of the work for which d’Alembert is remembered occurred outside mathematical physics. He was chosen as the science editor of the *Encyclopédie*, and his lengthy *Discours Préliminaire* in that volume is considered one of the defining documents of the Enlightenment. Other works included writings on law, religion, and music.

Since d’Alembert’s final years were not especially happy ones, perhaps this account of his life should end with a glimpse at the humanity his philosophy often gave his work. Like many of his contemporaries, he considered the problem of calculating the relative risk associated with the new practice of smallpox inoculation, which in rare cases caused the disease it was designed to prevent. Although not very successful in the mathematical sense, he was careful to point out that the probability of accidental infection, however slight or elegantly derived, would be small consolation to a father whose child died from the inoculation. It is greatly to his credit that d’Alembert did not believe such considerations irrelevant to the problem.

13.2 Separation of the Angular Part

With Cartesian and cylindrical variables, the boundary conditions are important in determining the nature of the solutions of the ODE obtained from the PDE. In almost all applications, however, the angular part of the spherical variables can be separated and studied very generally. This is because the angular part of the Laplacian in the spherical coordinate system is closely related to the operation of rotation and the angular momentum, which are independent of any particular situation.

The separation of the angular part in spherical coordinates can be done in a fashion exactly analogous to the separation of time by writing Ψ as a product of three functions, each depending on only one of the variables. However, we will follow an approach that is used in quantum mechanical treatments of angular momentum. This approach, which is based on the operator algebra of Chap. 4 and is extremely powerful and elegant, gives solutions for the angular part in closed form.

Define the vector operator $\vec{\mathbf{p}}$ as $\vec{\mathbf{p}} = -i\nabla$ so that its j th Cartesian component is $\mathbf{p}_j = -i\partial/\partial x_j$, for $j = 1, 2, 3$. In quantum mechanics $\vec{\mathbf{p}}$ (multiplied by \hbar) is the momentum operator. It is easy to verify that³

$$[x_j, \mathbf{p}_k] = i\delta_{jk} \quad \text{and} \quad [x_j, x_k] = 0 = [\mathbf{p}_j, \mathbf{p}_k]. \quad (13.10)$$

angular momentum operator We can also define the **angular momentum operator** as $\vec{\mathbf{L}} = \vec{\mathbf{r}} \times \vec{\mathbf{p}}$. This is expressed in components as $\mathbf{L}_i = (\vec{\mathbf{r}} \times \vec{\mathbf{p}})_i = \epsilon_{ijk} x_j \mathbf{p}_k$ for $i = 1, 2, 3$, where Einstein’s summation convention (summing over repeated indices) is

³These operators act on the space of functions possessing enough “nice” properties as to render the space suitable. The operator x_j simply multiplies functions, while \mathbf{p}_j differentiates them.

utilized.⁴ Using the commutation relations above, we obtain

$$[\mathbf{L}_j, \mathbf{L}_k] = i\epsilon_{jkl}\mathbf{L}_l.$$

We will see shortly that $\vec{\mathbf{L}}$ can be written solely in terms of the angles θ and φ . Moreover, there is one factor of $\vec{\mathbf{p}}$ in the definition of $\vec{\mathbf{L}}$, so if we square $\vec{\mathbf{L}}$, we will get two factors of $\vec{\mathbf{p}}$, and a Laplacian may emerge in the expression for $\vec{\mathbf{L}} \cdot \vec{\mathbf{L}}$. In this manner, we may be able to write ∇^2 in terms of \mathbf{L}^2 , which depends only on angles. Let us try this:

$$\begin{aligned} \mathbf{L}^2 &= \vec{\mathbf{L}} \cdot \vec{\mathbf{L}} = \sum_{i=1}^3 \mathbf{L}_i \mathbf{L}_i = \epsilon_{ijk}x_j \mathbf{p}_k \epsilon_{imn}x_m \mathbf{p}_n = \epsilon_{ijk}\epsilon_{imn}x_j \mathbf{p}_k x_m \mathbf{p}_n \\ &= (\delta_{jm}\delta_{kn} - \delta_{jn}\delta_{km})x_j \mathbf{p}_k x_m \mathbf{p}_n = x_j \mathbf{p}_k x_j \mathbf{p}_k - x_j \mathbf{p}_k x_k \mathbf{p}_j. \end{aligned}$$

We need to write this expression in such a way that factors with the same index are next to each other, to give a dot product. We must also try, when possible, to keep the $\vec{\mathbf{p}}$ factors to the right so that they can operate on functions without intervention from the x factors. We do this by using Eq. (13.10):

$$\begin{aligned} \mathbf{L}^2 &= x_j(x_j \mathbf{p}_k - i\delta_{kj})\mathbf{p}_k - (\mathbf{p}_k x_j + i\delta_{kj})x_k \mathbf{p}_j \\ &= x_j x_j \mathbf{p}_k \mathbf{p}_k - i x_j \mathbf{p}_j - \mathbf{p}_k x_k x_j \mathbf{p}_j - i x_j \mathbf{p}_j \\ &= x_j x_j \mathbf{p}_k \mathbf{p}_k - 2i x_j \mathbf{p}_j - (x_k \mathbf{p}_k - i\delta_{kk})x_j \mathbf{p}_j. \end{aligned}$$

Recalling that $\delta_{kk} = \sum_{k=1}^3 \delta_{kk} = 3$ and $x_j x_j = \sum_{j=1}^3 x_j x_j = \vec{\mathbf{r}} \cdot \vec{\mathbf{r}} = r^2$ etc., we can write $\mathbf{L}^2 = r^2 \vec{\mathbf{p}} \cdot \vec{\mathbf{p}} + i\vec{\mathbf{r}} \cdot \vec{\mathbf{p}} - (\vec{\mathbf{r}} \cdot \vec{\mathbf{p}})(\vec{\mathbf{r}} \cdot \vec{\mathbf{p}})$, which, if we make the substitution $\vec{\mathbf{p}} = -i\nabla$, yields

$$\nabla^2 = -r^{-2}\mathbf{L}^2 + r^{-2}(\mathbf{r} \cdot \nabla)(\mathbf{r} \cdot \nabla) + r^{-2}\mathbf{r} \cdot \nabla.$$

Letting both sides act on the function $\Psi(r, \theta, \varphi)$, we get

$$\nabla^2 \Psi = -\frac{1}{r^2}\mathbf{L}^2 \Psi + \frac{1}{r^2}(\mathbf{r} \cdot \nabla)(\mathbf{r} \cdot \nabla)\Psi + \frac{1}{r^2}\mathbf{r} \cdot \nabla \Psi. \tag{13.11}$$

But we note that $\mathbf{r} \cdot \nabla = r\hat{\mathbf{e}}_r \cdot \nabla = r\partial/\partial r$. We thus get the final form of $\nabla^2 \Psi$ in spherical coordinates:

$$\nabla^2 \Psi = -\frac{1}{r^2}\mathbf{L}^2 \Psi + \frac{1}{r}\frac{\partial}{\partial r}\left(r\frac{\partial \Psi}{\partial r}\right) + \frac{1}{r}\frac{\partial \Psi}{\partial r}. \tag{13.12}$$

It is important to note that Eq. (13.11) is a general relation that holds in all coordinate systems. Although all the manipulations leading to it were done in Cartesian coordinates, since it is written in vector notation, there is no indication in the final form that it was derived using specific coordinates.

commutation relations between components of angular momentum operator

Laplacian separated into angular and radial parts

⁴It is assumed that the reader is familiar with vector algebra using indices and such objects as δ_{ij} and ϵ_{ijk} . For an introductory treatment, sufficient for our present discussion, see [Hass 08]. A more advanced treatment of these objects (tensors) can be found in Part VIII of the present book.

Equation (13.12) is the spherical version of (13.11) and is the version we shall use. We will first make the simplifying assumption that in Eq. (13.9), the master equation, $f(\mathbf{r})$ is a function of r only. Equation (13.9) then becomes

$$-\frac{1}{r^2}\mathbf{L}^2\Psi + \frac{1}{r}\frac{\partial}{\partial r}\left(r\frac{\partial\Psi}{\partial r}\right) + \frac{1}{r}\frac{\partial\Psi}{\partial r} + f(r)\Psi = 0.$$

Assuming, for the time being, that \mathbf{L}^2 depends only on θ and φ , and separating Ψ into a product of two functions, $\Psi(r, \theta, \varphi) = R(r)Y(\theta, \varphi)$, we can rewrite this equation as

$$-\frac{1}{r^2}\mathbf{L}^2(RY) + \frac{1}{r}\frac{\partial}{\partial r}\left[r\frac{\partial}{\partial r}(RY)\right] + \frac{1}{r}\frac{\partial}{\partial r}(RY) + f(r)RY = 0.$$

Dividing by RY and multiplying by r^2 yields

$$\underbrace{-\frac{1}{Y}\mathbf{L}^2(Y)}_{-\alpha} + \underbrace{\frac{r}{R}\frac{d}{dr}\left(r\frac{dR}{dr}\right) + \frac{r}{R}\frac{dR}{dr} + r^2f(r)}_{+\alpha} = 0,$$

or

$$\mathbf{L}^2Y(\theta, \varphi) = \alpha Y(\theta, \varphi) \quad (13.13)$$

and

$$\frac{d^2R}{dr^2} + \frac{2}{r}\frac{dR}{dr} + \left[f(r) - \frac{\alpha}{r^2}\right]R = 0. \quad (13.14)$$

We will concentrate on the angular part, Eq. (13.13), leaving the radial part to the general discussion of ODEs. The rest of this section will focus on showing that $\mathbf{L}_1 \equiv \mathbf{L}_x$, $\mathbf{L}_2 \equiv \mathbf{L}_y$, and $\mathbf{L}_3 \equiv \mathbf{L}_z$ are independent of r .

Since \mathbf{L}_i is an operator, we can study its action on an arbitrary function f . Thus,

$$\mathbf{L}_i f = -i\epsilon_{ijk}x_j\nabla_k f \equiv -i\epsilon_{ijk}x_j\partial f/\partial x_k.$$

We can express the Cartesian x_j in terms of r , θ , and φ , and use the chain rule to express $\partial f/\partial x_k$ in terms of spherical coordinates. This will give us $\mathbf{L}_i f$ expressed in terms of r , θ , and φ . It will then emerge that r is absent in the final expression.

Let us start with

$$x = r \sin\theta \cos\varphi, \quad y = r \sin\theta \sin\varphi, \quad z = r \cos\theta,$$

and their inverse,

$$r = (x^2 + y^2 + z^2)^{1/2}, \quad \cos\theta = \frac{z}{r}, \quad \tan\varphi = \frac{y}{x},$$

and express the Cartesian derivatives in terms of spherical coordinates using the chain rule. The first such derivative is

$$\frac{\partial f}{\partial x} = \frac{\partial f}{\partial r}\frac{\partial r}{\partial x} + \frac{\partial f}{\partial\theta}\frac{\partial\theta}{\partial x} + \frac{\partial f}{\partial\varphi}\frac{\partial\varphi}{\partial x}. \quad (13.15)$$

The derivative of one coordinate system with respect to the other can be easily calculated. For example, $\partial r/\partial x = x/r = \sin\theta \cos\varphi$, and differentiating both sides of the equation $\cos\theta = z/r$, we obtain

$$\begin{aligned} -\sin\theta \frac{\partial\theta}{\partial x} &= -\frac{z\partial r/\partial x}{r^2} = -\frac{zx}{r^3} = -\frac{\cos\theta \sin\theta \cos\varphi}{r} \\ \Rightarrow \frac{\partial\theta}{\partial x} &= \frac{\cos\theta \cos\varphi}{r}. \end{aligned}$$

Finally, differentiating both sides of $\tan\varphi = y/x$ with respect to x yields $\partial\varphi/\partial x = -\sin\varphi/(r \sin\theta)$. Using these expressions in Eq. (13.15), we get

$$\frac{\partial f}{\partial x} = \sin\theta \cos\varphi \frac{\partial f}{\partial r} + \frac{\cos\theta \cos\varphi}{r} \frac{\partial f}{\partial\theta} - \frac{\sin\varphi}{r \sin\theta} \frac{\partial f}{\partial\varphi}.$$

In exactly the same way, we obtain

$$\begin{aligned} \frac{\partial f}{\partial y} &= \sin\theta \sin\varphi \frac{\partial f}{\partial r} + \frac{\cos\theta \sin\varphi}{r} \frac{\partial f}{\partial\theta} + \frac{\cos\varphi}{r \sin\theta} \frac{\partial f}{\partial\varphi}, \\ \frac{\partial f}{\partial z} &= \cos\theta \frac{\partial f}{\partial r} - \frac{\sin\theta}{r} \frac{\partial f}{\partial\theta}. \end{aligned}$$

We can now calculate \mathbf{L}_x by letting it act on an arbitrary function and expressing all Cartesian coordinates and derivatives in terms of spherical coordinates. The result is

$$\mathbf{L}_x f = -iy \frac{\partial f}{\partial z} + iz \frac{\partial f}{\partial y} = i \left(\sin\varphi \frac{\partial}{\partial\theta} + \cot\theta \cos\varphi \frac{\partial}{\partial\varphi} \right) f,$$

or

$$\mathbf{L}_x = i \left(\sin\varphi \frac{\partial}{\partial\theta} + \cot\theta \cos\varphi \frac{\partial}{\partial\varphi} \right). \quad (13.16)$$

Analogous arguments yield

$$\mathbf{L}_y = i \left(-\cos\varphi \frac{\partial}{\partial\theta} + \cot\theta \sin\varphi \frac{\partial}{\partial\varphi} \right), \quad \mathbf{L}_z = -i \frac{\partial}{\partial\varphi}. \quad (13.17)$$

It is left as a problem for the reader to show that by adding the squares of the components of the angular momentum operator, one obtains

$$\mathbf{L}^2 = -\frac{1}{\sin\theta} \frac{\partial}{\partial\theta} \left(\sin\theta \frac{\partial}{\partial\theta} \right) - \frac{1}{\sin^2\theta} \frac{\partial^2}{\partial\varphi^2}, \quad (13.18)$$

which is independent of r as promised. Substitution in Eq. (13.12) yields the familiar expression for the Laplacian in spherical coordinates.

Cartesian components of angular momentum operator expressed in spherical coordinates

angular momentum squared as differential operator in θ and φ

13.3 Construction of Eigenvalues of \mathbf{L}^2

Now that we have \mathbf{L}^2 in terms of θ and φ , we could substitute in Eq. (13.13), separate the θ and φ dependence, and solve the corresponding ODEs. However, there is a much more elegant way of solving this problem algebraically,

because Eq. (13.13) is simply an eigenvalue equation for \mathbf{L}^2 . In this section, we will find the eigenvalues of \mathbf{L}^2 . The next section will evaluate the eigenvectors of \mathbf{L}^2 .

Let us consider \mathbf{L}^2 as an abstract operator and write (13.13) as

$$\mathbf{L}^2|Y\rangle = \alpha|Y\rangle,$$

where $|Y\rangle$ is an abstract vector whose (θ, φ) th component can be calculated later. Since \mathbf{L}^2 is a differential operator, it does not have a (finite-dimensional) matrix representation. Thus, the determinantal procedure for calculating eigenvalues and eigenfunctions will not work here, and we have to find another way.

The equation above specifies an eigenvalue, α , and an eigenvector, $|Y\rangle$. There may be more than one $|Y\rangle$ corresponding to the same α . To distinguish among these so-called *degenerate eigenvectors*, we choose a second operator, say $\mathbf{L}_3 \in \{\mathbf{L}_i\}$ that commutes with \mathbf{L}^2 . This allows us to select a basis in which both \mathbf{L}^2 and \mathbf{L}_3 are diagonal, or, equivalently, a basis whose vectors are simultaneous eigenvectors of both \mathbf{L}^2 and \mathbf{L}_3 . This is possible by Theorem 6.4.18 and the fact that both \mathbf{L}^2 and \mathbf{L}_3 are hermitian operators in the space of square-integrable functions. (The proof is left as a problem.) In general, we would want to continue adding operators until we obtained a maximum set of commuting operators which could label the eigenvectors. In this case, \mathbf{L}^2 and \mathbf{L}_3 exhaust the set.⁵ Using the more common subscripts x , y , and z instead of 1, 2, 3 and attaching labels to the eigenvectors, we have

$$\mathbf{L}^2|Y_{\alpha,\beta}\rangle = \alpha|Y_{\alpha,\beta}\rangle, \quad \mathbf{L}_z|Y_{\alpha,\beta}\rangle = \beta|Y_{\alpha,\beta}\rangle. \quad (13.19)$$

The hermiticity of \mathbf{L}^2 and \mathbf{L}_z implies the reality of α and β . Next we need to determine the possible values for α and β .

Define two new operators $\mathbf{L}_+ \equiv \mathbf{L}_x + i\mathbf{L}_y$ and $\mathbf{L}_- \equiv \mathbf{L}_x - i\mathbf{L}_y$. It is then easily verified that

$$[\mathbf{L}^2, \mathbf{L}_\pm] = 0, \quad [\mathbf{L}_z, \mathbf{L}_\pm] = \pm\mathbf{L}_\pm, \quad [\mathbf{L}_+, \mathbf{L}_-] = 2\mathbf{L}_z. \quad (13.20)$$

The first equation implies that \mathbf{L}_\pm are invariant operators when acting in the subspace corresponding to the eigenvalue α ; that is, $\mathbf{L}_\pm|Y_{\alpha,\beta}\rangle$ are eigenvectors of \mathbf{L}^2 with the same eigenvalue α :

$$\mathbf{L}^2(\mathbf{L}_\pm|Y_{\alpha,\beta}\rangle) = \mathbf{L}_\pm(\mathbf{L}^2|Y_{\alpha,\beta}\rangle) = \mathbf{L}_\pm(\alpha|Y_{\alpha,\beta}\rangle) = \alpha\mathbf{L}_\pm|Y_{\alpha,\beta}\rangle.$$

The second equation in (13.20) yields

$$\begin{aligned} \mathbf{L}_z(\mathbf{L}_+|Y_{\alpha,\beta}\rangle) &= (\mathbf{L}_z\mathbf{L}_+)|Y_{\alpha,\beta}\rangle = (\mathbf{L}_+\mathbf{L}_z + \mathbf{L}_+)|Y_{\alpha,\beta}\rangle \\ &= \mathbf{L}_+\mathbf{L}_z|Y_{\alpha,\beta}\rangle + \mathbf{L}_+|Y_{\alpha,\beta}\rangle = \beta\mathbf{L}_+|Y_{\alpha,\beta}\rangle + \mathbf{L}_+|Y_{\alpha,\beta}\rangle \\ &= (\beta + 1)\mathbf{L}_+|Y_{\alpha,\beta}\rangle. \end{aligned}$$

⁵We could just as well have chosen \mathbf{L}^2 and any other component as our maximal set. However, \mathbf{L}^2 and \mathbf{L}_3 is the universally accepted choice.

This indicates that $\mathbf{L}_+|Y_{\alpha,\beta}\rangle$ has one more unit of the \mathbf{L}_z eigenvalue than $|Y_{\alpha,\beta}\rangle$ does. In other words, \mathbf{L}_+ raises the eigenvalue of \mathbf{L}_z by one unit. That is why \mathbf{L}_+ is called a **raising operator**. Similarly, \mathbf{L}_- is called a **lowering operator** because $\mathbf{L}_z(\mathbf{L}_-|Y_{\alpha,\beta}\rangle) = (\beta - 1)\mathbf{L}_-|Y_{\alpha,\beta}\rangle$.

angular momentum
raising and lowering
operators

We can summarize the above discussion as

$$\mathbf{L}_{\pm}|Y_{\alpha,\beta}\rangle = C_{\pm}|Y_{\alpha,\beta\pm 1}\rangle,$$

where C_{\pm} are constants to be determined by a suitable normalization.

There are restrictions on (and relations between) α and β . First note that as \mathbf{L}^2 is a sum of squares of hermitian operators, it must be a positive operator; that is, $\langle a|\mathbf{L}^2|a\rangle \geq 0$ for all $|a\rangle$. In particular,

$$0 \leq \langle Y_{\alpha,\beta}|\mathbf{L}^2|Y_{\alpha,\beta}\rangle = \alpha \langle Y_{\alpha,\beta}|Y_{\alpha,\beta}\rangle = \alpha \|Y_{\alpha,\beta}\|^2.$$

Therefore, $\alpha \geq 0$. Next, one can readily show that

$$\mathbf{L}^2 = \mathbf{L}_+\mathbf{L}_- + \mathbf{L}_z^2 - \mathbf{L}_z = \mathbf{L}_-\mathbf{L}_+ + \mathbf{L}_z^2 + \mathbf{L}_z. \quad (13.21)$$

Sandwiching both sides of the first equality between $|Y_{\alpha,\beta}\rangle$ and $\langle Y_{\alpha,\beta}|$ yields

$$\langle Y_{\alpha,\beta}|\mathbf{L}^2|Y_{\alpha,\beta}\rangle = \langle Y_{\alpha,\beta}|\mathbf{L}_+\mathbf{L}_-|Y_{\alpha,\beta}\rangle + \langle Y_{\alpha,\beta}|\mathbf{L}_z^2|Y_{\alpha,\beta}\rangle - \langle Y_{\alpha,\beta}|\mathbf{L}_z|Y_{\alpha,\beta}\rangle,$$

with an analogous expression involving $\mathbf{L}_-\mathbf{L}_+$. Using the fact that $\mathbf{L}_+ = (\mathbf{L}_-)^{\dagger}$, we get

$$\begin{aligned} \alpha \|Y_{\alpha,\beta}\|^2 &= \langle Y_{\alpha,\beta}|\mathbf{L}_+\mathbf{L}_-|Y_{\alpha,\beta}\rangle + \beta^2 \|Y_{\alpha,\beta}\|^2 - \beta \|Y_{\alpha,\beta}\|^2 \\ &= \langle Y_{\alpha,\beta}|\mathbf{L}_-\mathbf{L}_+|Y_{\alpha,\beta}\rangle + \beta^2 \|Y_{\alpha,\beta}\|^2 + \beta \|Y_{\alpha,\beta}\|^2 \\ &= \|\mathbf{L}_+|Y_{\alpha,\beta}\rangle\|^2 + \beta^2 \|Y_{\alpha,\beta}\|^2 \mp \beta \|Y_{\alpha,\beta}\|^2. \end{aligned} \quad (13.22)$$

Because of the positivity of norms, this yields $\alpha \geq \beta^2 - \beta$ and $\alpha \geq \beta^2 + \beta$. Adding these two inequalities gives $2\alpha \geq 2\beta^2 \Rightarrow -\sqrt{\alpha} \leq \beta \leq \sqrt{\alpha}$. It follows that the values of β are bounded. That is, there exist a maximum β , denoted by β_+ , and a minimum β , denoted by β_- , beyond which there are no more values of β . This can happen only if

$$\mathbf{L}_+|Y_{\alpha,\beta_+}\rangle = 0, \quad \mathbf{L}_-|Y_{\alpha,\beta_-}\rangle = 0,$$

because if $\mathbf{L}_{\pm}|Y_{\alpha,\beta_{\pm}}\rangle$ are not zero, then they must have values of β corresponding to $\beta_{\pm} \pm 1$, which are not allowed.

Using β_+ for β in Eq. (13.22) yields

$$(\alpha - \beta_+^2 - \beta_+) \|Y_{\alpha,\beta_+}\|^2 = 0.$$

By definition $|Y_{\alpha,\beta_+}\rangle \neq 0$ (otherwise $\beta_+ - 1$ would be the maximum). Thus, we obtain $\alpha = \beta_+^2 + \beta_+$. An analogous procedure using β_- for β yields $\alpha = \beta_-^2 - \beta_-$. We solve these two equations for β_+ and β_- :

$$\beta_+ = \frac{1}{2}(-1 \pm \sqrt{1 + 4\alpha}), \quad \beta_- = \frac{1}{2}(1 \pm \sqrt{1 + 4\alpha}).$$

Since $\beta_+ \geq \beta_-$ and $\sqrt{1+4\alpha} \geq 1$, we must choose

$$\beta_+ = \frac{1}{2}(-1 + \sqrt{1+4\alpha}) = -\beta_-.$$

Starting with $|Y_{\alpha, \beta_+}\rangle$, we can apply \mathbf{L}_- to it repeatedly. In each step we decrease the value of β by one unit. There must be a limit to the number of vectors obtained in this way, because β has a minimum. Therefore, there must exist a nonnegative integer k such that

$$(\mathbf{L}_-)^{k+1}|Y_{\alpha, \beta_+}\rangle = \mathbf{L}_-(\mathbf{L}_-^k|Y_{\alpha, \beta_+}\rangle) = 0.$$

Thus, $\mathbf{L}_-^k|Y_{\alpha, \beta_+}\rangle$ must be proportional to $|Y_{\alpha, \beta_-}\rangle$. In particular, since $\mathbf{L}_-^k|Y_{\alpha, \beta_+}\rangle$ has a β value equal to $\beta_+ - k$, we have $\beta_- = \beta_+ - k$. Now, using $\beta_- = -\beta_+$ (derived above) yields the important result

$$\beta_+ = \frac{k}{2} \equiv j \quad \text{for } k \in \mathbb{N},$$

or $\alpha = j(j+1)$, since $\alpha = \beta_+^2 + \beta_+$. This result is important enough to be stated as a theorem.

eigenvalues of \mathbf{L}^2 and \mathbf{L}_z
given

Theorem 13.3.1 *The eigenvectors of \mathbf{L}^2 , denoted by $|Y_{jm}\rangle$, satisfy the eigenvalue relations*

$$\mathbf{L}^2|Y_{jm}\rangle = j(j+1)|Y_{jm}\rangle, \quad \mathbf{L}_z|Y_{jm}\rangle = m|Y_{jm}\rangle,$$

where j is a positive integer or half-integer, and m can take a value in the set $\{-j, -j+1, \dots, j-1, j\}$ of $2j+1$ numbers.

Let us briefly consider the normalization of the eigenvectors. We already know that the $|Y_{jm}\rangle$, being eigenvectors of the hermitian operators \mathbf{L}^2 and \mathbf{L}_z , are orthogonal. We also demand that they be of unit norm; that is,

$$\langle Y_{jm}|Y_{j'm'}\rangle = \delta_{jj'}\delta_{mm'}. \quad (13.23)$$

This will determine the constants C_{\pm} , introduced earlier. Let us consider C_+ first, which is defined by $\mathbf{L}_+|Y_{jm}\rangle = C_+|Y_{j, m+1}\rangle$. The hermitian conjugate of this equation is $\langle Y_{jm}|\mathbf{L}_- = C_+^*\langle Y_{j, m+1}|$. We contract these two equations to get

$$\langle Y_{jm}|\mathbf{L}_-\mathbf{L}_+|Y_{jm}\rangle = |C_+|^2\langle Y_{j, m+1}|Y_{j, m+1}\rangle.$$

Then we use the second relation in Eq. (13.21), Theorem 13.3.1, and (13.23) to obtain

$$j(j+1) - m(m+1) = |C_+|^2 \Rightarrow |C_+| = \sqrt{j(j+1) - m(m+1)}.$$

Adopting the convention that the argument (phase) of the complex number C_+ is zero (and therefore that C_+ is real), we get

$$C_+ = \sqrt{j(j+1) - m(m+1)}$$

Similarly, $C_- = \sqrt{j(j+1) - m(m-1)}$.

Box 13.3.2 *The raising and lowering operators act on $|Y_{jm}\rangle$ as follows:*

$$\begin{aligned}\mathbf{L}_+|Y_{jm}\rangle &= \sqrt{j(j+1) - m(m+1)}|Y_{j,m+1}\rangle, \\ \mathbf{L}_-|Y_{jm}\rangle &= \sqrt{j(j+1) - m(m-1)}|Y_{j,m-1}\rangle.\end{aligned}\tag{13.24}$$

Example 13.3.3 Assume that $j = l$, a positive integer. Let us find an expression for $|Y_{lm}\rangle$ by repeatedly applying \mathbf{L}_- to $|Y_{ll}\rangle$. The action for \mathbf{L}_- is completely described by Eq. (13.24). For the first power of \mathbf{L}_- , we obtain

$$\mathbf{L}_-|Y_{ll}\rangle = \sqrt{l(l+1) - l(l-1)}|Y_{l,l-1}\rangle = \sqrt{2l}|Y_{l,l-1}\rangle.$$

We apply \mathbf{L}_- once more:

$$\begin{aligned}(\mathbf{L}_-)^2|Y_{ll}\rangle &= \sqrt{2l}\mathbf{L}_-|Y_{l,l-1}\rangle = \sqrt{2l}\sqrt{l(l+1) - (l-1)(l-2)}|Y_{l,l-2}\rangle \\ &= \sqrt{2l}\sqrt{2(2l-1)}|Y_{l,l-2}\rangle = \sqrt{2(2l)(2l-1)}|Y_{l,l-2}\rangle.\end{aligned}$$

Applying \mathbf{L}_- a third time yields

$$\begin{aligned}(\mathbf{L}_-)^3|Y_{ll}\rangle &= \sqrt{2(2l)(2l-1)}\mathbf{L}_-|Y_{l,l-2}\rangle = \sqrt{2(2l)(2l-1)}\sqrt{6(l-1)}|Y_{l,l-3}\rangle \\ &= \sqrt{3!(2l)(2l-1)(2l-2)}|Y_{l,l-3}\rangle.\end{aligned}$$

The pattern suggests the following formula for a general power k :

$$\mathbf{L}_-^k|Y_{ll}\rangle = \sqrt{k!(2l)(2l-1)\cdots(2l-k+1)}|Y_{l,l-k}\rangle,$$

or $\mathbf{L}_-^k|Y_{ll}\rangle = \sqrt{k!(2l)!/(2l-k)!}|Y_{l,l-k}\rangle$. If we set $l-k = m$ and solve for $|Y_{l,m}\rangle$, we get

$$|Y_{l,m}\rangle = \sqrt{\frac{(l+m)!}{(l-m)!(2l)!}}\mathbf{L}_-^{l-m}|Y_{ll}\rangle.$$

The discussion in this section is the standard treatment of angular momentum in quantum mechanics. In the context of quantum mechanics, Theorem 13.3.1 states the far-reaching physical result that particles can have integer or half-integer spin. Such a conclusion is tied to the rotation group in three dimensions, which, in turn, is an example of a Lie group, or a continuous group of transformations. We shall come back to a study of groups later. It is worth noting that it was the study of differential equations that led the Norwegian mathematician Sophus Lie to the investigation of their symmetries and the development of the beautiful branch of mathematics and theoretical physics that bears his name. Thus, the existence of a connection between group theory (rotation, angular momentum) and the differential equation we are trying to solve should not come as a surprise.

13.4 Eigenvectors of \mathbf{L}^2 : Spherical Harmonics

The treatment in the preceding section took place in an abstract vector space. Let us go back to the function space and represent the operators and vectors in terms of θ and φ .

First, let us consider \mathbf{L}_z in the form of a differential operator, as given in Eq. (13.17). The eigenvalue equation for \mathbf{L}_z becomes

$$-i \frac{\partial}{\partial \varphi} Y_{jm}(\theta, \varphi) = m Y_{jm}(\theta, \varphi).$$

We write $Y_{jm}(\theta, \varphi) = P_{jm}(\theta) Q_{jm}(\varphi)$ and substitute in the above equation to obtain the ODE for φ , $dQ_{jm}/d\varphi = imQ_{jm}$, which has a solution of the form $Q_{jm}(\varphi) = C_{jm} e^{im\varphi}$, where C_{jm} is a constant. Absorbing this constant into P_{jm} , we can write

$$Y_{jm}(\theta, \varphi) = P_{jm}(\theta) e^{im\varphi}.$$

In classical physics the value of functions must be the same at φ as at $\varphi + 2\pi$. This condition restricts the values of m to integers. In quantum mechanics, on the other hand, it is the absolute values of functions that are physically measurable quantities, and therefore m can also be a half-integer.

Box 13.4.1 *From now on, we shall assume that m is an integer and denote the eigenvectors of \mathbf{L}^2 by $Y_{lm}(\theta, \varphi)$, in which l is a nonnegative integer.*

Our task is to find an analytic expression for $Y_{lm}(\theta, \varphi)$. We need differential expressions for \mathbf{L}_\pm . These can easily be obtained from the expressions for \mathbf{L}_x and \mathbf{L}_y given in Eqs. (13.16) and (13.17). (The straightforward manipulations are left as a problem.) We thus have

$$\mathbf{L}_\pm = e^{\pm i\varphi} \left(\pm \frac{\partial}{\partial \theta} + i \cot \theta \frac{\partial}{\partial \varphi} \right). \quad (13.25)$$

Since l is the highest value of m , when \mathbf{L}_+ acts on $Y_{ll}(\theta, \varphi) = P_{ll}(\theta) e^{il\varphi}$ the result must be zero. This leads to the differential equation

$$\left(\frac{\partial}{\partial \theta} + i \cot \theta \frac{\partial}{\partial \varphi} \right) [P_{ll}(\theta) e^{il\varphi}] = 0 \quad \Rightarrow \quad \left(\frac{d}{d\theta} - l \cot \theta \right) P_{ll}(\theta) = 0.$$

The solution to this differential equation is readily found to be

$$P_{ll}(\theta) = C_l (\sin \theta)^l. \quad (13.26)$$

The constant is subscripted because each P_{ll} may lead to a different constant of integration. We can now write

$$Y_{ll}(\theta, \varphi) = C_l (\sin \theta)^l e^{il\varphi}.$$

With $Y_{ll}(\theta, \varphi)$ at our disposal, we can obtain any $Y_{lm}(\theta, \varphi)$ by repeated application of \mathbf{L}_- . In principle, the result of Example 13.3.3 gives all the (abstract) eigenvectors. In practice, however, it is helpful to have a closed form (in terms of derivatives) for just the θ part of $Y_{lm}(\theta, \varphi)$. So, let us apply \mathbf{L}_- , as given in Eq. (13.25) to $Y_{ll}(\theta, \varphi)$:

$$\begin{aligned}\mathbf{L}_- Y_{ll} &= e^{-i\varphi} \left(-\frac{\partial}{\partial \theta} + i \cot \theta \frac{\partial}{\partial \varphi} \right) [P_{ll}(\theta) e^{il\varphi}] \\ &= e^{-i\varphi} \left[-\frac{\partial}{\partial \theta} + i \cot \theta (il) \right] [P_{ll}(\theta) e^{il\varphi}] \\ &= (-1) e^{i(l-1)\varphi} \left(\frac{d}{d\theta} + l \cot \theta \right) P_{ll}(\theta).\end{aligned}$$

It can be shown that for a positive integer,

$$\left(\frac{d}{d\theta} + n \cot \theta \right) f(\theta) = \frac{1}{\sin^n \theta} \frac{d}{d\theta} [\sin^n \theta f(\theta)]. \quad (13.27)$$

Using this result and (13.26) yields

$$\begin{aligned}\mathbf{L}_- Y_{ll} &= (-1) e^{i(l-1)\varphi} \frac{1}{\sin^l \theta} \frac{d}{d\theta} [\sin^l \theta (C_l \sin^l \theta)] \\ &= (-1) C_l \frac{e^{i(l-1)\varphi}}{\sin^l \theta} \frac{d}{d\theta} (\sin^{2l} \theta).\end{aligned} \quad (13.28)$$

We apply \mathbf{L}_- to (13.28), and use Eq. (13.27) with $n = l - 1$ to obtain

$$\begin{aligned}\mathbf{L}_-^2 Y_{ll} &= (-1)^2 C_l e^{i(l-2)\varphi} \frac{1}{\sin^{l-1} \theta} \frac{d}{d\theta} \left[\sin^{l-1} \theta \frac{1}{\sin^l \theta} \frac{d}{d\theta} (\sin^{2l} \theta) \right] \\ &= (-1)^2 C_l \frac{e^{i(l-2)\varphi}}{\sin^{l-1} \theta} \frac{d}{d\theta} \left[\frac{1}{\sin \theta} \frac{d}{d\theta} (\sin^{2l} \theta) \right].\end{aligned}$$

Making the substitution $u = \cos \theta$ yields

$$\mathbf{L}_-^2 Y_{ll} = C_l \frac{e^{i(l-2)\varphi}}{(1-u^2)^{l/2-1}} \frac{d^2}{du^2} [(1-u^2)^l].$$

With a little more effort one can detect a pattern and obtain

$$\mathbf{L}_-^k Y_{ll} = C_l \frac{e^{i(l-k)\varphi}}{(1-u^2)^{(l-k)/2}} \frac{d^k}{du^k} [(1-u^2)^l].$$

If we let $k = l - m$ and make use of the result obtained in Example 13.3.3, we obtain

$$Y_{lm}(\theta, \varphi) = \sqrt{\frac{(l+m)!}{(l-m)!(2l)!}} C_l \frac{e^{im\varphi}}{(1-u^2)^{m/2}} \frac{d^{l-m}}{du^{l-m}} [(1-u^2)^l].$$

To specify $Y_{lm}(\theta, \varphi)$ completely, we need to evaluate C_l . Since C_l does not depend on m , we set $m = 0$ in the above expression, obtaining

$$Y_{l0}(u, \varphi) = \frac{1}{\sqrt{(2l)!}} C_l \frac{d^l}{du^l} [(1-u^2)^l].$$

The RHS looks very much like the Legendre polynomial of Chap. 8. In fact,

$$Y_{l0}(u, \varphi) = \frac{C_l}{\sqrt{(2l)!}} (-1)^l 2^l l! P_l(u) \equiv A_l P_l(u). \quad (13.29)$$

Therefore, the normalization of Y_{l0} and the Legendre polynomials P_l determines C_l .

We now use Eq. (7.25) to obtain the integral form of the orthonormality relation for Y_{lm} :

$$\begin{aligned} \delta_{ll'} \delta_{mm'} &= \langle Y_{l'm'} | Y_{lm} \rangle = \langle Y_{l'm'} | \left(\int_0^{2\pi} d\varphi \int_0^\pi \sin\theta d\theta |\theta, \varphi\rangle \langle \theta, \varphi| \right) | Y_{lm} \rangle \\ &= \int_0^{2\pi} d\varphi \int_0^\pi Y_{l'm'}^*(\theta, \varphi) Y_{lm}(\theta, \varphi) \sin\theta d\theta, \end{aligned} \quad (13.30)$$

which in terms of $u = \cos\theta$ becomes

$$\int_0^{2\pi} d\varphi \int_{-1}^1 Y_{l'm'}^*(u, \varphi) Y_{lm}(u, \varphi) du = \delta_{ll'} \delta_{mm'}. \quad (13.31)$$

Problem 13.15 shows that using (13.30) one gets $A_l = \sqrt{(2l+1)/(4\pi)}$. Therefore, Eq. (13.29) yields not only the value of C_l , but also the useful relation

$$Y_{l0}(u, \varphi) = \sqrt{\frac{2l+1}{4\pi}} P_l(u). \quad (13.32)$$

Substituting the value of C_l thus obtained, we finally get

$$\begin{aligned} Y_{lm}(\theta, \varphi) &= (-1)^l \sqrt{\frac{2l+1}{4\pi}} \frac{e^{im\varphi}}{2^l l!} \sqrt{\frac{(l+m)!}{(l-m)!}} (1-u^2)^{-m/2} \\ &\quad \times \frac{d^{l-m}}{du^{l-m}} [(1-u^2)^l], \end{aligned} \quad (13.33)$$

where $u = \cos\theta$. These functions, the eigenfunctions of \mathbf{L}^2 and \mathbf{L}_z , are called spherical harmonics **spherical harmonics**. They occur frequently in those physical applications for which the Laplacian is expressed in terms of spherical coordinates.

One can immediately read off the θ part of the spherical harmonics:

$$P_{lm}(u) = (-1)^l \sqrt{\frac{2l+1}{4\pi}} \frac{1}{2^l l!} \sqrt{\frac{(l+m)!}{(l-m)!}} (1-u^2)^{-m/2} \frac{d^{l-m}}{du^{l-m}} [(1-u^2)^l].$$

associated Legendre functions However, this is not the version used in the literature. For historical reasons the **associated Legendre functions** $P_l^m(u)$ are used. These are defined by

$$\begin{aligned} P_l^m(u) &= (-1)^m \sqrt{\frac{(l+m)!}{(l-m)!}} \sqrt{\frac{4\pi}{2l+1}} P_{lm}(u) \\ &= (-1)^{l+m} \frac{(l+m)!}{(l-m)!} \frac{(1-u^2)^{-m/2}}{2^l l!} \frac{d^{l-m}}{du^{l-m}} [(1-u^2)^l]. \end{aligned}$$

Thus,

Box 13.4.2 *The solutions of the angular part of the Laplacian are*

$$Y_{lm}(\theta, \varphi) = (-1)^m \left[\frac{2l+1}{4\pi} \frac{(l-m)!}{(l+m)!} \right]^{1/2} P_l^m(\cos \theta) e^{im\varphi}, \quad (13.34)$$

where, with $u = \cos \theta$,

$$P_l^m(u) = (-1)^{l+m} \frac{(l+m)!}{(l-m)!} \frac{(1-u^2)^{-m/2}}{2^l l!} \frac{d^{l-m}}{du^{l-m}} [(1-u^2)^l]. \quad (13.35)$$

We generated the spherical harmonics starting with $Y_{ll}(\theta, \varphi)$ and applying the lowering operator \mathbf{L}_- . We could have started with $Y_{l,-l}(\theta, \varphi)$ instead, and applied the raising operator \mathbf{L}_+ . The latter procedure is identical to the former; nevertheless, we outline it below because of some important relations that emerge along the way. We first note that

$$|Y_{l,-m}\rangle = \sqrt{\frac{(l+m)!}{(l-m)!(2l)!}} \mathbf{L}_+^{l-m} |Y_{l,-l}\rangle. \quad (13.36)$$

(This can be obtained following the steps of Example 13.3.3.) Next, we use $\mathbf{L}_- |Y_{l,-l}\rangle = 0$ in differential form to obtain

$$\left(\frac{d}{d\theta} - l \cot \theta \right) P_{l,-l}(\theta) = 0,$$

which has the same form as the differential equation for P_{ll} . Thus, the solution is $P_{l,-l}(\theta) = C_l' (\sin \theta)^l$, and

$$Y_{l,-l}(\theta, \varphi) = P_{l,-l}(\theta) e^{-il\varphi} = C_l' (\sin \theta)^l e^{-il\varphi}.$$

Applying \mathbf{L}_+ repeatedly yields

$$\mathbf{L}_+^k Y_{l,-l}(u, \varphi) = C_l' \frac{(-1)^k e^{-i(l-k)\varphi}}{(1-u^2)^{(l-k)/2}} \frac{d^k}{du^k} [(1-u^2)^l],$$

where $u = \cos \theta$. Substituting $k = l - m$ and using Eq. (13.36) gives

$$Y_{l,-m}(u, \varphi) = \sqrt{\frac{(l+m)!}{(l-m)!(2l)!}} C_l' \frac{(-1)^{l-m} e^{-im\varphi}}{(1-u^2)^{m/2}} \frac{d^{l-m}}{du^{l-m}} [(1-u^2)^l].$$

The constant C'_l can be determined as before. In fact, for $m = 0$ we get exactly the same result as before, so we expect C'_l to be identical to C_l . Thus,

$$Y_{l,-m}(u, \varphi) = (-1)^{l+m} \sqrt{\frac{2l+1}{4\pi}} \frac{e^{-im\varphi}}{2^l l!} \sqrt{\frac{(l+m)!}{(l-m)!}} \\ \times (1-u^2)^{-m/2} \frac{d^{l-m}}{du^{l-m}} [(1-u^2)^l].$$

Comparison with Eq. (13.33) yields

$$Y_{l,-m}(\theta, \varphi) = (-1)^m Y_{l,m}^*(\theta, \varphi), \quad (13.37)$$

and using the definition $Y_{l,-m}(\theta, \varphi) = P_{l,-m}(\theta) e^{-im\varphi}$ and the first part of Eq. (13.35), we obtain

$$P_l^{-m}(\theta) = (-1)^m \frac{(l-m)!}{(l+m)!} P_l^m(\theta). \quad (13.38)$$

The first few spherical harmonics with positive m are given below. Those with negative m can be obtained using Eq. (13.37).

$$\text{For } l=0, \quad Y_{00} = \frac{1}{\sqrt{4\pi}}.$$

$$\text{For } l=1, \quad Y_{10} = \sqrt{\frac{3}{4\pi}} \cos \theta, \quad Y_{11} = -\sqrt{\frac{3}{8\pi}} e^{i\varphi} \sin \theta.$$

$$\text{For } l=2, \quad Y_{20} = \sqrt{\frac{5}{16\pi}} (3 \cos^2 \theta - 1),$$

$$Y_{21} = -\sqrt{\frac{15}{8\pi}} e^{i\varphi} \sin \theta \cos \theta,$$

$$Y_{22} = \sqrt{\frac{15}{32\pi}} e^{2i\varphi} \sin^2 \theta.$$

$$\text{For } l=3, \quad Y_{30} = \sqrt{\frac{7}{16\pi}} (5 \cos^3 \theta - 3 \cos \theta),$$

$$Y_{31} = -\sqrt{\frac{21}{64\pi}} e^{i\varphi} \sin \theta (5 \cos^2 \theta - 1),$$

$$Y_{32} = \sqrt{\frac{105}{32\pi}} e^{2i\varphi} \sin^2 \theta \cos \theta,$$

$$Y_{33} = -\sqrt{\frac{35}{64\pi}} e^{3i\varphi} \sin^3 \theta.$$

From Eqs. (13.13), (13.18), and (13.34) and the fact that $\alpha = l(l+1)$ for some nonnegative integer l , we obtain

$$\frac{1}{\sin\theta} \frac{\partial}{\partial\theta} \left(\sin\theta \frac{\partial}{\partial\theta} \right) [P_l^m e^{im\varphi}] + \frac{1}{\sin^2\theta} \frac{\partial^2}{\partial\varphi^2} [P_l^m e^{im\varphi}] + l(l+1) P_l^m e^{im\varphi} = 0,$$

which gives

$$\frac{1}{\sin\theta} \frac{d}{d\theta} \left(\sin\theta \frac{dP_l^m}{d\theta} \right) - \frac{m^2}{\sin^2\theta} P_l^m + l(l+1) P_l^m = 0.$$

As before, we let $u = \cos\theta$ to obtain

$$\frac{d}{du} \left[(1-u^2) \frac{dP_l^m}{du} \right] + \left[l(l+1) - \frac{m^2}{1-u^2} \right] P_l^m = 0. \quad (13.39)$$

This is called the **associated Legendre differential equation**. Its solutions, the associated Legendre functions, are given in closed form in Eq. (13.35). For $m = 0$, Eq. (13.39) reduces to the Legendre differential equation whose solutions, again given by Eq. (13.35) with $m = 0$, are the Legendre polynomials encountered in Chap. 8. When $m = 0$, the spherical harmonics become φ -independent. This corresponds to a physical situation in which there is an explicit azimuthal symmetry. In such cases (when it is obvious that the physical property in question does not depend on φ) a Legendre polynomial, depending only on $\cos\theta$, will multiply the radial function.

associated Legendre differential equation

13.4.1 Expansion of Angular Functions

The orthonormality of spherical harmonics can be utilized to expand functions of θ and φ in terms of them. The fact that these functions are complete will be discussed in a general way in the context of Sturm-Liouville systems. Assuming completeness for now, we write

$$f(\theta, \varphi) = \begin{cases} \sum_{l=0}^{\infty} \sum_{m=-l}^l a_{lm} Y_{lm}(\theta, \varphi) & \text{if } l \text{ is not fixed,} \\ \sum_{m=-l}^l a_{lm} Y_{lm}(\theta, \varphi) & \text{if } l \text{ is fixed,} \end{cases} \quad (13.40)$$

where we have included the case where it is known a priori that $f(\theta, \varphi)$ has a given fixed l value. To find a_{lm} , we multiply both sides by $Y_{lm}^*(\theta, \varphi)$ and integrate over the solid angle. The result, obtained by using the orthonormality relation, is

$$a_{lm} = \iint d\Omega f(\theta, \varphi) Y_{lm}^*(\theta, \varphi), \quad (13.41)$$

where $d\Omega \equiv \sin\theta d\theta d\varphi$ is the element of solid angle. A useful special case of this formula is

$$\begin{aligned} a_{l0}^{(f)} &= \iint d\Omega f(\theta, \varphi) Y_{l0}^*(\theta, \varphi) \\ &= \sqrt{\frac{2l+1}{4\pi}} \iint d\Omega f(\theta, \varphi) P_l(\cos\theta), \end{aligned} \quad (13.42)$$

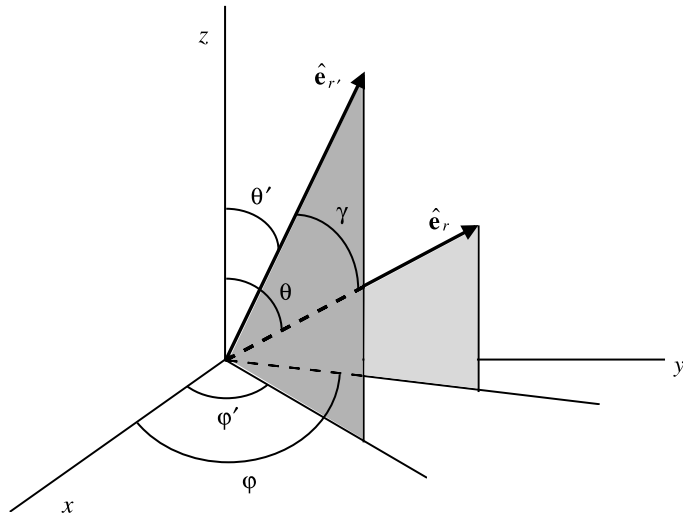

Fig. 13.1 The unit vectors \hat{e}_r and $\hat{e}_{r'}$ with their spherical angles and the angle γ between them

where we have introduced an extra superscript to emphasize the relation of the expansion coefficients with the function being expanded. Another useful relation is obtained when we let $\theta = 0$ in Eq. (13.40):

$$f(\theta, \varphi)|_{\theta=0} = \begin{cases} \sum_{l=0}^{\infty} \sum_{m=-l}^l a_{lm}^{(f)} Y_{lm}(\theta, \varphi)|_{\theta=0} & \text{if } l \text{ is not fixed,} \\ \sum_{m=-l}^l a_{lm}^{(f)} Y_{lm}(\theta, \varphi)|_{\theta=0} & \text{if } l \text{ is fixed.} \end{cases}$$

From Eqs. (13.35) and (13.34) one can show that

$$Y_{lm}(\theta, \varphi)|_{\theta=0} = \delta_{m0} Y_{l0}(0, \varphi) = \delta_{m0} \sqrt{\frac{2l+1}{4\pi}}.$$

Therefore,

$$f(\theta, \varphi)|_{\theta=0} = \begin{cases} \sum_{l=0}^{\infty} a_{l0}^{(f)} \sqrt{\frac{2l+1}{4\pi}} & \text{if } l \text{ is not fixed,} \\ a_{l0}^{(f)} \sqrt{\frac{2l+1}{4\pi}} & \text{if } l \text{ is fixed.} \end{cases} \quad (13.43)$$

13.4.2 Addition Theorem for Spherical Harmonics

An important consequence of the expansion in terms of Y_{lm} is called the **addition theorem** for spherical harmonics. Consider two unit vectors \hat{e}_r and $\hat{e}_{r'}$ making spherical angles (θ, φ) and (θ', φ') , respectively, as shown in Fig. 13.1. Let γ be the angle between the two vectors. The addition theorem states that

$$P_l(\cos \gamma) = \frac{4\pi}{2l+1} \sum_{m=-l}^l Y_{lm}^*(\theta', \varphi') Y_{lm}(\theta, \varphi). \quad (13.44)$$

We shall not give a proof of this theorem here and refer the reader to an elegant proof on page 974 which uses the representation theory of groups. The addition theorem is particularly useful in the expansion of the frequently occurring expression $1/|\mathbf{r}-\mathbf{r}'|$. For definiteness we assume $|\mathbf{r}'| \equiv r' < |\mathbf{r}| \equiv r$. Then, introducing $t = r'/r$, we have

$$\frac{1}{|\mathbf{r}-\mathbf{r}'|} = \frac{1}{(r^2 + r'^2 - 2rr' \cos \gamma)^{1/2}} = \frac{1}{r} (1 + t^2 - 2t \cos \gamma)^{-1/2}.$$

Recalling the generating function for Legendre polynomials from Chap. 8 and using the addition theorem, we get

$$\begin{aligned} \frac{1}{|\mathbf{r}-\mathbf{r}'|} &= \frac{1}{r} \sum_{l=0}^{\infty} t^l P_l(\cos \gamma) = \sum_{l=0}^{\infty} \frac{r'^l}{r^{l+1}} \frac{4\pi}{2l+1} \sum_{m=-l}^l Y_{lm}^*(\theta', \varphi') Y_{lm}(\theta, \varphi) \\ &= 4\pi \sum_{l=0}^{\infty} \sum_{m=-l}^l \frac{1}{2l+1} \frac{r'^l}{r^{l+1}} Y_{lm}^*(\theta', \varphi') Y_{lm}(\theta, \varphi). \end{aligned}$$

It is clear that if $r < r'$, we should expand in terms of the ratio r/r' . It is therefore customary to use $r_<$ to denote the smaller and $r_>$ to denote the larger of the two radii r and r' . Then the above equation is written as

expansion of $1/|\mathbf{r}-\mathbf{r}'|$ in spherical coordinates

$$\frac{1}{|\mathbf{r}-\mathbf{r}'|} = 4\pi \sum_{l=0}^{\infty} \sum_{m=-l}^l \frac{1}{2l+1} \frac{r_<^l}{r_>^{l+1}} Y_{lm}^*(\theta', \varphi') Y_{lm}(\theta, \varphi). \quad (13.45)$$

This equation is used frequently in the study of Coulomb-like potentials.

13.5 Problems

13.1 By applying the operator $[x_j, \mathbf{p}_k]$ to an arbitrary function $f(\mathbf{r})$, show that $[x_j, \mathbf{p}_k] = i\delta_{jk}$.

13.2 Use the defining relation $\mathbf{L}_i = \epsilon_{ijk} x_j \mathbf{p}_k$ to show that $x_j \mathbf{p}_k - x_k \mathbf{p}_j = \epsilon_{ijk} \mathbf{L}_i$. In both of these expressions a sum over the repeated indices is understood.

13.3 For the angular momentum operator $\mathbf{L}_i = \epsilon_{ijk} x_j \mathbf{p}_k$, show that the commutation relation $[\mathbf{L}_j, \mathbf{L}_k] = i\epsilon_{jkl} \mathbf{L}_l$ holds.

13.4 Evaluate $\partial f/\partial y$ and $\partial f/\partial z$ in spherical coordinates and find \mathbf{L}_y and \mathbf{L}_z in terms of spherical coordinates.

13.5 Obtain an expression for \mathbf{L}^2 in terms of θ and φ , and substitute the result in Eq. (13.12) to get the Laplacian in spherical coordinates.

13.6 Show that $\mathbf{L}^2 = \mathbf{L}_+ \mathbf{L}_- + \mathbf{L}_z^2 - \mathbf{L}_z$ and $\mathbf{L}^2 = \mathbf{L}_- \mathbf{L}_+ + \mathbf{L}_z^2 + \mathbf{L}_z$.

13.7 Show that \mathbf{L}^2 , \mathbf{L}_x , \mathbf{L}_y , and \mathbf{L}_z are hermitian operators in the space of square-integrable functions.

13.8 Verify the following commutation relations:

$$[\mathbf{L}^2, \mathbf{L}_\pm] = 0, \quad [\mathbf{L}_z, \mathbf{L}_\pm] = \pm \mathbf{L}_\pm, \quad [\mathbf{L}_+, \mathbf{L}_-] = 2\mathbf{L}_z.$$

13.9 Show that $\mathbf{L}_-|Y_{\alpha\beta}\rangle$ has $\beta - 1$ as its eigenvalue for \mathbf{L}_z , and that $|Y_{\alpha,\beta\pm}\rangle$ cannot be zero.

13.10 Show that if the $|Y_{jm}\rangle$ are normalized to unity, then with proper choice of phase, $\mathbf{L}_-|Y_{jm}\rangle = \sqrt{j(j+1) - m(m-1)}|Y_{j,m-1}\rangle$.

13.11 Derive Eq. (13.36).

13.12 Starting with \mathbf{L}_x and \mathbf{L}_y , derive the following expression for \mathbf{L}_\pm :

$$\mathbf{L}_\pm = e^{\pm i\varphi} \left(\pm \frac{\partial}{\partial \theta} + i \cot \theta \frac{\partial}{\partial \varphi} \right).$$

13.13 Integrate $dP/d\theta - l \cot \theta P = 0$ to find $P(\theta)$.

13.14 Verify the following differential identity:

$$\left(\frac{d}{d\theta} + n \cot \theta \right) f(\theta) = \frac{1}{\sin^n \theta} \frac{d}{d\theta} [\sin^n \theta f(\theta)].$$

13.15 Let $l = l'$ and $m = m' = 0$ in Eq. (13.31), and substitute for Y_{l0} from Eq. (13.29) to obtain $A_l = \sqrt{(2l+1)/4\pi}$.

13.16 Show that

$$\mathbf{L}_+^k Y_{l,-l}(u, \varphi) = C_l' \frac{(-1)^k e^{-i(l-k)\varphi}}{(1-u^2)^{(l-k)/2}} \frac{d^k}{du^k} [(1-u^2)^l].$$

13.17 Derive the relations $Y_{l,-m}(\theta, \varphi) = (-1)^m Y_{l,m}^*(\theta, \varphi)$ and

$$P_l^{-m}(\theta) = (-1)^m \frac{(l-m)!}{(l+m)!} P_l^m(\theta).$$

13.18 Show that

$$\sum_{m=-l}^l |Y_{lm}(\theta, \varphi)|^2 = \frac{2l+1}{4\pi}.$$

Verify this explicitly for $l = 1$ and $l = 2$.

13.19 Show that the addition theorem for spherical harmonics can be written as

$$P_l(\cos \gamma) = P_l(\cos \theta)P_l(\cos \theta') \\ + 2 \sum_{m=1}^l \frac{(l-m)!}{(l+m)!} P_l^m(\cos \theta)P_l^m(\cos \theta') \cos[m(\varphi - \varphi')].$$

The discussion of Chap. 13 has clearly singled out ODEs, especially those of second order, as objects requiring special attention because most common PDEs of mathematical physics can be separated into ODEs (of second order). This is really an oversimplification of the situation. Many PDEs of physics, both at the fundamental theoretical level (as in the general theory of relativity) and from a practical standpoint (weather forecast) are nonlinear, and the method of the separation of variables does not work. Since no general analytic solutions for such nonlinear systems have been found, we shall confine ourselves to the linear systems, especially those that admit a separated solution.

With the exception of the infinite power series, no systematic method of solving DEs existed during the first half of the nineteenth century. The majority of solutions were completely ad hoc and obtained by trial and error, causing frustration and anxiety among mathematicians. It was to overcome this frustration that Sophus Lie, motivated by the newly developed concept of group, took up the systematic study of DEs in the second half of the nineteenth century. This study not only gave a handle on the disarrayed area of DEs, but also gave birth to one of the most beautiful and fundamental branches of mathematical physics, Lie group theory. We shall come back to a thorough treatment of this theory in Parts VII and IX.

Our main task in this chapter is to study the second-order linear differential equations (SOLDEs). However, to understand SOLDEs, we need some basic understanding of differential equations in general. The next section outlines some essential properties of general DEs. Section 2 is a very brief introduction to first-order DEs, and the remainder of the chapter deals with SOLDEs.

14.1 General Properties of ODEs

The most general ODE can be expressed as

$$G\left(x, y, \frac{dy}{dx}, \frac{d^2y}{dx^2}, \dots, \frac{d^n y}{dx^n}\right) = 0, \quad (14.1)$$

in which $G : \mathbb{R}^{n+2} \rightarrow \mathbb{R}$ is a real-valued function of $n + 2$ real variables. When G depends explicitly and nontrivially on $d^n y/dx^n$, Eq. (14.1) is called an *n*th-order ODE. An ODE is said to be **linear** if the part of the function G that includes y and all its derivatives is linear in y . The most general *n*th-order *linear* ODE is

$$p_0(x)y + p_1(x)\frac{dy}{dx} + \cdots + p_n(x)\frac{d^n y}{dx^n} = q(x) \quad \text{for } p_n(x) \neq 0, \quad (14.2)$$

homogeneous and
inhomogeneous ODEs

where $\{p_i\}_{i=0}^n$ and q are functions of the independent variable x . Equation (14.2) is said to be **homogeneous** if $q = 0$; otherwise, it is said to be **inhomogeneous** and $q(x)$ is called the *inhomogeneous term*. It is customary, and convenient, to define a linear differential operator \mathbf{L} by¹

$$\mathbf{L} \equiv p_0(x) + p_1(x)\frac{d}{dx} + \cdots + p_n(x)\frac{d^n}{dx^n}, \quad p_n(x) \neq 0, \quad (14.3)$$

and write Eq. (14.2) as

$$\mathbf{L}[y] = q(x). \quad (14.4)$$

A **solution** of Eq. (14.1) or (14.4) is a single-variable function $f : \mathbb{R} \rightarrow \mathbb{R}$ such that $G(x, f(x), f'(x), \dots, f^{(n)}(x)) = 0$, or $\mathbf{L}[f] = q(x)$, for all x in the domain of definition of f . The solution of a differential equation may not exist if we put too many restrictions on it. For instance, if we demand that $f : \mathbb{R} \rightarrow \mathbb{R}$ be differentiable too many times, we may not be able to find a solution, as the following example shows.

Example 14.1.1 The most general solution of $dy/dx = |x|$ that vanishes at $x = 0$ is

$$f(x) = \begin{cases} \frac{1}{2}x^2 & \text{if } x \geq 0, \\ -\frac{1}{2}x^2 & \text{if } x \leq 0. \end{cases}$$

This function is continuous and has first derivative $f'(x) = |x|$, which is also continuous at $x = 0$. However, if we demand that its second derivative also be continuous at $x = 0$, we cannot find a solution, because

$$f''(x) = \begin{cases} +1 & \text{if } x > 0, \\ -1 & \text{if } x < 0. \end{cases}$$

If we want $f'''(x)$ to exist at $x = 0$, then we have to expand the notion of a function to include distributions, or generalized functions.

Overrestricting a solution for a differential equation results in its absence, but underrestricting it allows multiple solutions. To strike a balance between these two extremes, we agree to make a solution as many times differentiable as plausible and to satisfy certain **initial conditions**. For an *n*th-order

¹Do not confuse this linear differential operator with the angular momentum (vector) operator $\vec{\mathbf{L}}$.

DE such initial conditions are commonly equivalent (but not restricted) to a specification of the function and of its first $n - 1$ derivatives. This sort of specification is made feasible by the following theorem.

Theorem 14.1.2 (Implicit function theorem) *Let $G : \mathbb{R}^{n+1} \rightarrow \mathbb{R}$ have continuous partial derivatives up to the k th order in some neighborhood of a point $P_0 = (r_1, r_2, \dots, r_{n+1})$ in \mathbb{R}^{n+1} . Let $(\partial G / \partial x_{n+1})|_{P_0} \neq 0$. Then there exists a unique function $F : \mathbb{R}^n \rightarrow \mathbb{R}$ that is continuously differentiable k times at (some smaller) neighborhood of P_0 such that*

implicit function theorem

$$x_{n+1} = F(x_1, x_2, \dots, x_n)$$

for all points $P = (x_1, x_2, \dots, x_{n+1})$ in a neighborhood of P_0 and

$$G(x_1, x_2, \dots, x_n, F(x_1, x_2, \dots, x_n)) = 0.$$

Theorem 14.1.2 simply asserts that under certain (mild) conditions we can “solve” for one of the independent variables in $G(x_1, x_2, \dots, x_{n+1}) = 0$ in terms of the others. A proof of this theorem can be found in advanced calculus books.

Application of this theorem to Eq. (14.1) leads to

$$\frac{d^n y}{dx^n} = F\left(x, y, \frac{dy}{dx}, \frac{d^2 y}{dx^2}, \dots, \frac{d^{n-1} y}{dx^{n-1}}\right),$$

provided that G satisfies the conditions of the theorem. If we know the solution $y = f(x)$ and its derivatives up to order $n - 1$, we can evaluate its n th derivative using this equation. In addition, we can calculate the derivatives of all orders (assuming they exist) by differentiating this equation. This allows us to expand the solution in a Taylor series. Thus—for solutions that have derivatives of all orders—knowledge of the value of a solution and its first $n - 1$ derivatives at a point x_0 determines that solution at a neighboring point x .

We shall not study the general ODE of Eq. (14.1) or even its simpler linear version (14.2). We will only briefly study ODEs of the first order in the next section, and then concentrate on linear ODEs of the second order for the rest of this chapter.

14.2 Existence/Uniqueness for First-Order DEs

A general first-order DE (FODE) is of the form $G(x, y, y') = 0$. We can find y' (the derivative of y) in terms of a function of x and y if the function $G(x_1, x_2, x_3)$ is differentiable with respect to its third argument and $\partial G / \partial x_3 \neq 0$. In that case we have

the most general FODE in normal form

$$y' \equiv \frac{dy}{dx} = F(x, y), \quad (14.5)$$

which is said to be a **normal** FODE. If $F(x, y)$ is a *linear* function of y , then Eq. (14.5) becomes a first-order linear DE (FOLDE), which can generally be written as

$$p_1(x) \frac{dy}{dx} + p_0(x)y = q(x). \tag{14.6}$$

It can be shown that the general FOLDE has an explicit solution: (see [Hass 08])

explicit solution to a general first-order linear differential equation

Theorem 14.2.1 *Any first order linear DE of the form $p_1(x)y' + p_0(x)y = q(x)$, in which p_0 , p_1 , and q are continuous functions in some interval (a, b) , has a general solution*

$$y = f(x) = \frac{1}{\mu(x)p_1(x)} \left[C + \int_{x_1}^x \mu(t)q(t) dt \right], \tag{14.7}$$

where C is an arbitrary constant and

$$\mu(x) = \frac{1}{p_1(x)} \exp \left[\int_{x_0}^x \frac{p_0(t)}{p_1(t)} dt \right], \tag{14.8}$$

where x_0 and x_1 are arbitrary points in the interval (a, b) .

No such explicit solution exists for nonlinear first-order DEs. Nevertheless, it is reassuring to know that a solution of such a DE always exists and under some mild conditions, this solution is unique. We summarize some of the ideas involved in the proof of the existence and uniqueness of the solutions to FODEs. (For proofs, see the excellent book by Birkhoff and Rota [Birk 78].) We first state an existence theorem due to Peano:

Peano existence theorem

Theorem 14.2.2 (Peano existence theorem) *If the function $F(x, y)$ is continuous for the points on and within the rectangle defined by $|y - c| \leq K$ and $|x - a| \leq N$, and if $|F(x, y)| \leq M$ there, then the differential equation $y' = F(x, y)$ has at least one solution, $y = f(x)$, defined for $|x - a| \leq \min(N, K/M)$ and satisfying the initial condition $f(a) = c$.*

This theorem guarantees only the existence of solutions. To ensure uniqueness, the function F needs to have some additional properties. An important property is stated in the following definition.

Lipschitz condition

Definition 14.2.3 A function $F(x, y)$ satisfies a **Lipschitz condition** in a domain $D \subset \mathbb{R}^2$ if for some finite constant L (*Lipschitz constant*), it satisfies the inequality

$$|F(x, y_1) - F(x, y_2)| \leq L|y_1 - y_2|$$

for all points (x, y_1) and (x, y_2) in D .

uniqueness theorem

Theorem 14.2.4 (Uniqueness) *Let $f(x)$ and $g(x)$ be any two solutions of*

the FODE $y' = F(x, y)$ in a domain D , where F satisfies a Lipschitz condition with Lipschitz constant L . Then

$$|f(x) - g(x)| \leq e^{L|x-a|} |f(a) - g(a)|.$$

In particular, the FODE has at most one solution curve passing through the point $(a, c) \in D$.

The final conclusion of this theorem is an easy consequence of the assumed differentiability of F and the requirement $f(a) = g(a) = c$. The theorem says that if there is a solution $y = f(x)$ to the DE $y' = F(x, y)$ satisfying $f(a) = c$, then it is *the* solution.

The requirements of the Peano existence theorem are too broad to yield solutions that have some nice properties. For instance, the interval of definition of the solutions may depend on their initial values. The following example illustrates this point.

Example 14.2.5 Consider the DE $dy/dx = e^y$. The general solution of this DE can be obtained by direct integration:

$$e^{-y} dy = dx \Rightarrow -e^{-y} = x + C.$$

If $y = b$ when $x = 0$, then $C = -e^{-b}$, and

$$e^{-y} = -x + e^{-b} \Rightarrow y = -\ln(e^{-b} - x).$$

Thus, the solution is defined for $-\infty < x < e^{-b}$, i.e., the interval of definition of a solution changes with its initial value.

To avoid situations illustrated in the example above, one demands not just the continuity of F —as does the Peano existence theorem—but a Lipschitz condition for it. Then one ensures not only the existence, but also the uniqueness:

Theorem 14.2.6 (Local existence and uniqueness) *Suppose that the function $F(x, y)$ is defined and continuous in the rectangle*

$$|y - c| \leq K, \quad |x - a| \leq N$$

and satisfies a Lipschitz condition there. Let $M = \max |F(x, y)|$ in this rectangle. Then the differential equation $y' = F(x, y)$ has a unique solution $y = f(x)$ satisfying $f(a) = c$ and defined on the interval $|x - a| \leq \min(N, K/M)$.

local existence and uniqueness theorem

14.3 General Properties of SOLDEs

The most general SOLDE is

$$p_2(x) \frac{d^2 y}{dx^2} + p_1(x) \frac{dy}{dx} + p_0(x) y = p_3(x). \quad (14.9)$$

Dividing by $p_2(x)$ and writing p for p_1/p_2 , q for p_0/p_2 , and r for p_3/p_2 reduces this to the **normal form** of a SOLDE

$$\frac{d^2y}{dx^2} + p(x)\frac{dy}{dx} + q(x)y = r(x). \tag{14.10}$$

Equation (14.10) is equivalent to (14.9) if $p_2(x) \neq 0$. The points at which $p_2(x)$ vanishes are called the **singular points** of the differential equation.

There is a crucial difference between the singular points of linear differential equations and those of nonlinear differential equations. For a nonlinear differential equation such as $(x^2 - y)y' = x^2 + y^2$, the curve $y = x^2$ is the collection of singular points. This makes it impossible to construct solutions $y = f(x)$ that are defined on an interval $I = [a, b]$ of the x -axis because for any $x \in I$, there is a y for which the differential equation is undefined. *Linear* differential equations do not have this problem, because the coefficients of the derivatives are functions of x only. Therefore, all the singular “curves” are vertical. Thus, we have the following:

Definition 14.3.1 The normal form of a SOLDE, Eq. (14.10), is **regular** on an interval $[a, b]$ of the x -axis if $p(x)$, $q(x)$, and $r(x)$ are continuous on $[a, b]$. A solution of a normal SOLDE is a *twice-differentiable* function $y = f(x)$ that satisfies the SOLDE at every point of $[a, b]$.

Any function that satisfies (14.10) or (14.9) must necessarily be twice differentiable, and that is all that is demanded of the solutions. Any higher-order differentiability requirement may be too restrictive, as was pointed out in Example 14.1.1. Most solutions to a normal SOLDE, however, automatically have derivatives of order higher than two.

We write Eq. (14.9) in the operator form as

$$\mathbf{L}[y] = p_3, \quad \text{where } \mathbf{L} \equiv p_2 \frac{d^2}{dx^2} + p_1 \frac{d}{dx} + p_0. \tag{14.11}$$

It is clear that \mathbf{L} is a *linear* operator because d/dx is linear, as are all powers of it. Thus, for constants α and β ,

$$\mathbf{L}[\alpha y_1 + \beta y_2] = \alpha \mathbf{L}[y_1] + \beta \mathbf{L}[y_2].$$

In particular, if y_1 and y_2 are two solutions of Eq. (14.11), then $\mathbf{L}[y_1 - y_2] = 0$. That is, the difference between any two solutions of a SOLDE is a solution of the **homogeneous equation** obtained by setting $p_3 = 0$.²

An immediate consequence of the linearity of \mathbf{L} is the following:

Lemma 14.3.2 *If $\mathbf{L}[u] = r(x)$, $\mathbf{L}[v] = s(x)$, α and β are constants, and $w = \alpha u + \beta v$, then $\mathbf{L}[w] = \alpha r(x) + \beta s(x)$.*

The proof of this lemma is trivial, but the result describes the fundamental property of linear operators: When $r = s = 0$, that is, in dealing with

²This conclusion is, of course, not limited to the SOLDE; it holds for all linear DEs.

homogeneous equations, the lemma says that any linear combination of solutions of the homogeneous SOLDE (HSOLDE) is also a solution. This is called the **superposition principle**.

superposition principle

Based on physical intuition, we expect to be able to predict the behavior of a physical system if we know the differential equation obeyed by that system, and, equally importantly, the initial data. Physical intuition also tells us that if the initial conditions are changed by an infinitesimal amount, then the solutions will be changed infinitesimally. Thus, the solutions of linear differential equations are said to be continuous functions of the initial conditions.

Remark 14.3.1 Nonlinear differential equations can have completely different solutions for two initial conditions that are infinitesimally close. Since initial conditions cannot be specified with mathematical precision in practice, nonlinear differential equations lead to unpredictable solutions, or **chaos**. Chaos was a hot topic in the late 1980s and early 1990s. Some enthusiasts called it the third pillar of modern physics on a par with relativity and quantum physics. The enthusiasm has waned, however, because chaos, driven entirely by the availability of computers and their superb graphic capabilities, has produced absolutely no fundamental results comparable with relativity and quantum theory.

The rise and fall of chaos

A prediction is not a prediction unless it is unique. This expectation for linear equations is borne out in the language of mathematics in the form of an existence theorem and a uniqueness theorem. We consider the latter next. But first, we need a lemma.

Lemma 14.3.3 *The only solution $g(x)$ of the homogeneous differential equation $y'' + py' + qy = 0$ defined on the interval $[a, b]$ that satisfies $g(a) = 0 = g'(a)$ is the trivial solution $g = 0$.*

Proof Introduce the nonnegative function $u(x) \equiv [g(x)]^2 + [g'(x)]^2$ and differentiate it to get

$$\begin{aligned} u'(x) &= 2g'g + 2g'g'' = 2g'(g + g'') = 2g'(g - pg' - qg) \\ &= -2p(g')^2 + 2(1 - q)gg'. \end{aligned}$$

Since $(g \pm g')^2 \geq 0$, it follows that $2|gg'| \leq g^2 + g'^2$. Thus,

$$\begin{aligned} 2(1 - q)gg' &\leq 2|(1 - q)gg'| = 2|(1 - q)||gg'| \\ &\leq |(1 - q)|(g^2 + g'^2) \leq (1 + |q|)(g^2 + g'^2), \end{aligned}$$

and therefore,

$$\begin{aligned} u'(x) &\leq |u'(x)| = |-2pg'^2 + 2(1 - q)gg'| \\ &\leq 2|p|g'^2 + (1 + |q|)(g^2 + g'^2) \\ &= [1 + |q(x)|]g^2 + [1 + |q(x)| + 2|p(x)|]g'^2. \end{aligned}$$

Now let $K = 1 + \max[|q(x)| + 2|p(x)|]$, where the maximum is taken over $[a, b]$. Then we obtain

$$u'(x) \leq K(g^2 + g'^2) = Ku(x) \quad \forall x \in [a, b].$$

Using the result of Problem 14.1 yields $u(x) \leq u(a)e^{K(x-a)}$ for all $x \in [a, b]$. This equation, plus $u(a) = 0$, as well as the fact that $u(x) \geq 0$ imply that $u(x) = g^2(x) + g'^2(x) = 0$. It follows that $g(x) = 0 = g'(x)$ for all $x \in [a, b]$. \square

uniqueness of solutions
to SOLDE

Theorem 14.3.4 (Uniqueness) *If p and q are continuous on $[a, b]$, then at most one solution $y = f(x)$ of the DE $y'' + p(x)y' + q(x)y = 0$ can satisfy the initial conditions $f(a) = c_1$ and $f'(a) = c_2$, where c_1 and c_2 are arbitrary constants.*

Proof Let f_1 and f_2 be two solutions satisfying the given initial conditions. Then their difference, $g \equiv f_1 - f_2$, satisfies the homogeneous equation [with $r(x) = 0$]. The initial condition that $g(x)$ satisfies is clearly $g(a) = 0 = g'(a)$. By Lemma 14.3.3, $g = 0$ or $f_1 = f_2$. \square

Theorem 14.3.4 can be applied to any *homogeneous* SOLDE to find the latter's most general solution. In particular, let $f_1(x)$ and $f_2(x)$ be any two solutions of

$$y'' + p(x)y' + q(x)y = 0 \tag{14.12}$$

defined on the interval $[a, b]$. Assume that the two vectors $\mathbf{v}_1 = (f_1(a), f_1'(a))$ and $\mathbf{v}_2 = (f_2(a), f_2'(a))$ in \mathbb{R}^2 are linearly independent.³ Let $g(x)$ be another solution. The vector $(g(a), g'(a))$ can be written as a linear combination of \mathbf{v}_1 and \mathbf{v}_2 , giving the two equations

$$g(a) = c_1 f_1(a) + c_2 f_2(a),$$

$$g'(a) = c_1 f_1'(a) + c_2 f_2'(a).$$

Now consider the function $u(x) \equiv g(x) - c_1 f_1(x) - c_2 f_2(x)$, which satisfies Eq. (14.12) and the initial conditions $u(a) = u'(a) = 0$. By Lemma 14.3.3, we must have $u(x) = 0$ or $g(x) = c_1 f_1(x) + c_2 f_2(x)$. We have proved the following:

Theorem 14.3.5 *Let f_1 and f_2 be two solutions of the HSOLDE*

$$y'' + py' + qy = 0,$$

³If they are not, then one must choose a different initial point for the interval.

where p and q are continuous functions defined on the interval $[a, b]$. If

$$(f_1(a), f_1'(a)) \quad \text{and} \quad (f_2(a), f_2'(a))$$

are linearly independent vectors in \mathbb{R}^2 , then every solution $g(x)$ of this HSOLDE is equal to some linear combination $g(x) = c_1 f_1(x) + c_2 f_2(x)$ of f_1 and f_2 with constant coefficients c_1 and c_2 .

14.4 The Wronskian

The two solutions $f_1(x)$ and $f_2(x)$ in Theorem 14.3.5 have the property that any other solution $g(x)$ can be expressed as a linear combination of them. We call f_1 and f_2 a **basis of solutions** of the HSOLDE. To form a basis of solutions, f_1 and f_2 must be linearly independent.⁴

Definition 14.4.1 The **Wronskian** of any two differentiable functions $f_1(x)$ and $f_2(x)$ is

$$W(f_1, f_2; x) = f_1(x)f_2'(x) - f_2(x)f_1'(x) = \det \begin{pmatrix} f_1(x) & f_1'(x) \\ f_2(x) & f_2'(x) \end{pmatrix}.$$

Proposition 14.4.2 The Wronskian of any two solutions of Eq. (14.12) satisfies

$$W(f_1, f_2; x) = W(f_1, f_2; c)e^{-\int_c^x p(t)dt},$$

where c is any number in the interval $[a, b]$.

Proof Differentiating both sides of the definition of Wronskian and substituting from Eq. (14.12) yields a FOLDE for $W(f_1, f_2; x)$, which can be easily solved. The details are left as a problem. \square

An important consequence of Proposition 14.4.2 is that the Wronskian of any two solutions of Eq. (14.12) does not change sign in $[a, b]$. In particular, if the Wronskian vanishes at one point in $[a, b]$, it vanishes at all points in $[a, b]$.

The real importance of the Wronskian is contained in the following theorem, whose straightforward proof is left as an exercise for the reader.

Theorem 14.4.3 Two differentiable functions f_1 and f_2 , which are nonzero in the interval $[a, b]$, are linearly dependent if and only if their Wronskian vanishes.

Historical Notes

Josef Hoëné de Wronski (1778–1853) was born Josef Hoëné, but he adopted the name Wronski around 1810 just after he married. He had moved to France and become a French

⁴The linear dependence or independence of a number of functions $\{f_i\}_{i=1}^n : [a, b] \rightarrow \mathbb{R}$ is a concept that must hold for all $x \in [a, b]$.



Josef Hoëné de Wronski
1778–1853

citizen in 1800 and moved to Paris in 1810, the same year he published his first memoir on the foundations of mathematics, which received less than favorable reviews from Lacroix and Lagrange. His other interests included the design of caterpillar vehicles to compete with the railways. However, they were never manufactured.

Wronski was interested mainly in applying philosophy to mathematics, the philosophy taking precedence over rigorous mathematical proofs. He criticised Lagrange's use of infinite series and introduced his own ideas for series expansions of a function. The coefficients in this series are determinants now known as **Wronskians** [so named by Thomas Muir (1844–1934), a Glasgow High School science master who became an authority on determinants by devoting most of his life to writing a five-volume treatise on the history of determinants].

For many years Wronski's work was dismissed as rubbish. However, a closer examination of the work in more recent times shows that although some is wrong and he has an incredibly high opinion of himself and his ideas, there are also some mathematical insights of great depth and brilliance hidden within the papers.

14.4.1 A Second Solution to the HSOLDE

If we know one solution to Eq. (14.12), say f_1 , then by differentiating both sides of

$$f_1(x)f_2'(x) - f_2(x)f_1'(x) = W(x) = W(c)e^{-\int_c^x p(t) dt},$$

dividing the result by f_1^2 , and noting that the LHS will be the derivative of f_2/f_1 , we can solve for f_2 in terms of f_1 . The result is

$$f_2(x) = f_1(x) \left\{ C + K \int_{\alpha}^x \frac{1}{f_1^2(s)} \exp \left[- \int_c^s p(t) dt \right] ds \right\},$$

where $K \equiv W(c)$ is another arbitrary (nonzero) constant; we do not have to know $W(x)$ (this would require knowledge of f_2 , which we are trying to calculate!) to obtain $W(c)$. In fact, the reader is urged to check directly that $f_2(x)$ satisfies the DE of (14.12) for arbitrary C and K . Whenever possible—and convenient—it is customary to set $C = 0$, because its presence simply gives a term that is proportional to the known solution $f_1(x)$.

Theorem 14.4.4 Let f_1 be a solution of $y'' + p(x)y' + q(x)y = 0$. Then

$$f_2(x) = f_1(x) \int_{\alpha}^x \frac{1}{f_1^2(s)} \exp \left[- \int_c^s p(t) dt \right] ds,$$

is another solution and $\{f_1, f_2\}$ forms a basis of solutions of the DE.

Example 14.4.5 Here are some examples of finding the second solution from the first:

- (a) A solution to the SOLDE $y'' - k^2y = 0$ is e^{kx} . To find a second solution, we let $C = 0$ and $K = 1$ in Theorem 14.4.4. Since $p(x) = 0$, we have

$$f_2(x) = e^{kx} \left(0 + \int_{\alpha}^x \frac{ds}{e^{2ks}} \right) = -\frac{1}{2k} e^{-kx} + \frac{e^{-2k\alpha}}{2k} e^{kx},$$

which, ignoring the second term (which is proportional to the first solution), leads directly to the choice of e^{-kx} as a second solution.

- (b) The differential equation $y'' + k^2y = 0$ has $\sin kx$ as a solution. With $C = 0$, $\alpha = \pi/(2k)$, and $K = 1$, we get

$$f_2(x) = \sin kx \left(0 + \int_{\pi/2k}^x \frac{ds}{\sin^2 ks} \right) = -\sin kx \cot ks \Big|_{\pi/2k}^x = -\cos kx.$$

- (c) For the solutions in part (a),

$$W(x) = \det \begin{pmatrix} e^{kx} & k e^{kx} \\ e^{-kx} & -k e^{-kx} \end{pmatrix} = -2k,$$

and for those in part (b),

$$W(x) = \det \begin{pmatrix} \sin kx & k \cos kx \\ \cos kx & -k \sin kx \end{pmatrix} = -k.$$

Both Wronskians are constant. In general, the Wronskian of any two linearly independent solutions of $y'' + q(x)y = 0$ is constant.

Most special functions used in mathematical physics are solutions of SOLDEs. The behavior of these functions at certain special points is determined by the physics of the particular problem. In most situations physical expectation leads to a preference for one particular solution over the other. For example, although there are two linearly independent solutions to the Legendre DE

$$\frac{d}{dx} \left[(1-x^2) \frac{dy}{dx} \right] + n(n+1)y = 0,$$

the solution that is most frequently encountered is the Legendre polynomial $P_n(x)$ discussed in Chap. 8. The other solution can be obtained by solving the Legendre equation or by using Theorem 14.4.4, as done in the following example.

Example 14.4.6 The Legendre equation can be reexpressed as

$$\frac{d^2y}{dx^2} - \frac{2x}{1-x^2} \frac{dy}{dx} + \frac{n(n+1)}{1-x^2} y = 0.$$

This is an HSOLDE with

$$p(x) = -\frac{2x}{1-x^2} \quad \text{and} \quad q(x) = \frac{n(n+1)}{1-x^2}.$$

One solution of this HSOLDE is the well-known Legendre polynomial $P_n(x)$. Using this as our input and employing Theorem 14.4.4, we can generate another set of solutions.

Let $Q_n(x)$ stand for the linearly independent “partner” of $P_n(x)$. Then

$$\begin{aligned} Q_n(x) &= P_n(x) \int_{\alpha}^x \frac{1}{P_n^2(s)} \exp\left[\int_0^s \frac{2t}{1-t^2} dt\right] ds \\ &= P_n(x) \int_{\alpha}^x \frac{1}{P_n^2(s)} \left[\frac{1}{1-s^2}\right] ds = A_n P_n(x) \int_{\alpha}^x \frac{ds}{(1-s^2)P_n^2(s)}, \end{aligned}$$

where A_n is an arbitrary constant determined by standardization, and α is an arbitrary point in the interval $[-1, +1]$. For instance, for $n = 0$, we have $P_0 = 1$, and we obtain

$$Q_0(x) = A_0 \int_{\alpha}^x \frac{ds}{1-s^2} = A_0 \left[\frac{1}{2} \ln \left| \frac{1+x}{1-x} \right| - \frac{1}{2} \ln \left| \frac{1+\alpha}{1-\alpha} \right| \right].$$

The standard form of $Q_0(x)$ is obtained by setting $A_0 = 1$ and $\alpha = 0$:

$$Q_0(x) = \frac{1}{2} \ln \left| \frac{1+x}{1-x} \right| \quad \text{for } |x| < 1.$$

Similarly, since $P_1(x) = x$,

$$Q_1(x) = A_1 x \int_{\alpha}^x \frac{ds}{s^2(1-s^2)} = Ax + Bx \ln \left| \frac{1+x}{1-x} \right| + C \quad \text{for } |x| < 1.$$

Here standardization is $A = 0$, $B = \frac{1}{2}$, and $C = -1$. Thus,

$$Q_1(x) = \frac{1}{2} x \ln \left| \frac{1+x}{1-x} \right| - 1.$$

14.4.2 The General Solution to an ISOLDE

Inhomogeneous SOLDEs (ISOLDEs) can be most elegantly discussed in terms of Green’s functions, the subject of Chap. 20, which automatically incorporate the boundary conditions. However, the most general solution of an ISOLDE, with no boundary specification, can be discussed at this point.

Let $g(x)$ be a particular solution of

$$\mathbf{L}[y] = y'' + py' + qy = r(x) \quad (14.13)$$

and let $h(x)$ be any other solution of this equation. Then $h(x) - g(x)$ satisfies Eq. (14.12) and can be written as a linear combination of a basis of solutions $f_1(x)$ and $f_2(x)$, leading to the following equation:

$$h(x) = c_1 f_1(x) + c_2 f_2(x) + g(x). \quad (14.14)$$

Thus, if we have a *particular* solution of the ISOLDE of Eq. (14.13) and two basis solutions of the HSOLDE, then the *most general* solution of (14.13) can be expressed as the sum of a linear combination of the two basis solutions and the particular solution.

We know how to find a second solution to the HSOLDE once we know one solution. We now show that knowing one such solution will also allow us to find a particular solution to the ISOLDE. The method we use is called the **variation of constants**. This method can also be used to find a second solution to the HSOLDE.

method of variation of constants

Let f_1 and f_2 be the two (known) solutions of the HSOLDE and $g(x)$ the sought-after solution to Eq. (14.13). Write g as $g(x) = f_1(x)v(x)$ and substitute it in (14.13) to get a SOLDE for $v(x)$:

$$v'' + \left(p + \frac{2f_1'}{f_1} \right) v' = \frac{r}{f_1}.$$

This is a *first* order linear DE in v' , which has a solution of the form

$$v' = \frac{W(x)}{f_1^2(x)} \left[C + \int_a^x \frac{f_1(t)r(t)}{W(t)} dt \right],$$

where $W(x)$ is the (known) Wronskian of Eq. (14.13). Substituting

$$\frac{W(x)}{f_1^2(x)} = \frac{f_1(x)f_2'(x) - f_2(x)f_1'(x)}{f_1^2(x)} = \frac{d}{dx} \left(\frac{f_2}{f_1} \right)$$

in the above expression for v' and setting $C = 0$ (we are interested in a *particular* solution), we get

$$\begin{aligned} \frac{dv}{dx} &= \frac{d}{dx} \left(\frac{f_2}{f_1} \right) \int_a^x \frac{f_1(t)r(t)}{W(t)} dt \\ &= \frac{d}{dx} \left[\frac{f_2(x)}{f_1(x)} \int_a^x \frac{f_1(t)r(t)}{W(t)} dt \right] - \frac{f_2(x)}{f_1(x)} \underbrace{\frac{d}{dx} \int_a^x \frac{f_1(t)r(t)}{W(t)} dt}_{= f_1(x)r(x)/W(x)} \end{aligned}$$

and

$$v(x) = \frac{f_2(x)}{f_1(x)} \int_a^x \frac{f_1(t)r(t)}{W(t)} dt - \int_a^x \frac{f_2(t)r(t)}{W(t)} dt.$$

This leads to the particular solution

$$g(x) = f_1(x)v(x) = f_2(x) \int_a^x \frac{f_1(t)r(t)}{W(t)} dt - f_1(x) \int_a^x \frac{f_2(t)r(t)}{W(t)} dt. \quad (14.15)$$

We just proved the following result:

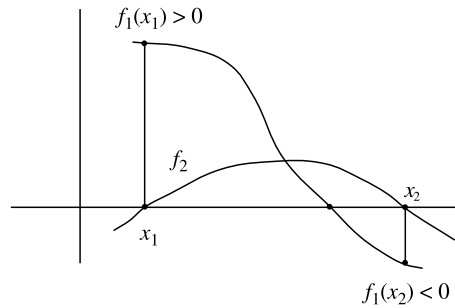

Fig. 14.1 If $f_2'(x_1) > 0 > f_2'(x_2)$, then (assuming that the Wronskian is positive) $f_1(x_1) > 0 > f_1(x_2)$

Proposition 14.4.7 Given a single solution $f_1(x)$ of the HSOLDE corresponding to an ISOLDE, one can use Theorem 14.4.4 to find a second solution $f_2(x)$ of the HSOLDE and Eq. (14.15) to find a particular solution $g(x)$ of the ISOLDE. The most general solution h will then be

$$h(x) = c_1 f_1(x) + c_2 f_2(x) + g(x).$$

14.4.3 Separation and Comparison Theorems

The Wronskian can be used to derive some properties of the graphs of solutions of HSOLDEs. One such property concerns the relative position of the zeros of two linearly independent solutions of an HSOLDE.

the separation theorem

Theorem 14.4.8 (Separation) *The zeros of two linearly independent solutions of an HSOLDE occur alternately.*

Proof Let $f_1(x)$ and $f_2(x)$ be two independent solutions of Eq. (14.12). We have to show that a zero of f_1 exists between any two zeros of f_2 . The linear independence of f_1 and f_2 implies that $W(f_1, f_2; x) \neq 0$ for any $x \in [a, b]$. Let $x_i \in [a, b]$ be a zero of f_2 . Then

$$0 \neq W(f_1, f_2; x_i) = f_1(x_i)f_2'(x_i) - f_2(x_i)f_1'(x_i) = f_1(x_i)f_2'(x_i).$$

Thus, $f_1(x_i) \neq 0$ and $f_2'(x_i) \neq 0$. Suppose that x_1 and x_2 —where $x_2 > x_1$ —are two successive zeros of f_2 . Since f_2 is continuous in $[a, b]$ and $f_2'(x_1) \neq 0$, f_2 has to be either increasing [$f_2'(x_1) > 0$] or decreasing [$f_2'(x_1) < 0$] at x_1 . For f_2 to be zero at x_2 , the next point, $f_2'(x_2)$ must have the *opposite* sign from $f_2'(x_1)$ (see Fig. 14.1). We proved earlier that the sign of the Wronskian does not change in $[a, b]$ (see Proposition 14.4.2 and comments after it). The above equation then says that $f_1(x_1)$ and $f_1(x_2)$ also have opposite signs. The continuity of f_1 then implies that f_1 must cross the x -axis

somewhere between x_1 and x_2 . A similar argument shows that there exists one zero of f_2 between any two zeros of f_1 . \square

Example 14.4.9 Two linearly independent solutions of $y'' + y = 0$ are $\sin x$ and $\cos x$. The separation theorem suggests that the zeros of $\sin x$ and $\cos x$ must alternate, a fact known from elementary trigonometry: The zeros of $\cos x$ occur at odd multiples of $\pi/2$, and those of $\sin x$ occur at even multiples of $\pi/2$.

A second useful result is known as the comparison theorem (for a proof, see [Birk 78, p. 38]).

Theorem 14.4.10 (Comparison) *Let f and g be nontrivial solutions of $u'' + p(x)u = 0$ and $v'' + q(x)v = 0$, respectively, where $p(x) \geq q(x)$ for all $x \in [a, b]$. Then f vanishes at least once between any two zeros of g , unless $p = q$ and f is a constant multiple of g .* the comparison theorem

The form of the differential equations used in the comparison theorem is not restrictive because any HSOLDE can be cast in this form, as the following proposition shows.

Proposition 14.4.11 *If $y'' + p(x)y' + q(x)y = 0$, then*

$$u = y \exp \left[\frac{1}{2} \int_{\alpha}^x p(t) dt \right]$$

satisfies $u'' + S(x)u = 0$, where $S(x) = q - \frac{1}{4}p^2 - \frac{1}{2}p'$.

Proof Define $w(x)$ by $y = wu$, and substitute in the HSOLDE to obtain

$$(u'w + w'u)' + p(u'w + w'u) + quw = 0,$$

or

$$wu'' + (2w' + pw)u' + (qw + pw' + w'')u = 0. \quad (14.16)$$

If we demand that the coefficient of u' be zero, we obtain the DE $2w' + pw = 0$, whose solution is

$$w(x) = C \exp \left[-\frac{1}{2} \int_{\alpha}^x p(t) dt \right].$$

Dividing (14.16) by this w and substituting for w yields

$$u'' + S(x)u = 0, \quad \text{where} \quad S(x) = q + p \frac{w'}{w} + \frac{w''}{w} = q - \frac{1}{4}p^2 - \frac{1}{2}p'.$$

\square

A useful special case of the comparison theorem is given as the following corollary whose straightforward but instructive proof is left as a problem.

Corollary 14.4.12 *If $q(x) \leq 0$ for all $x \in [a, b]$, then no nontrivial solution of the differential equation $v'' + q(x)v = 0$ can have more than one zero.*

Example 14.4.13 It should be clear from the preceding discussion that the oscillations of the solutions of $v'' + q(x)v = 0$ are mostly determined by the sign and magnitude of $q(x)$. For $q(x) \leq 0$ there is no oscillation; that is, there is no solution that changes sign more than once. Now suppose that $q(x) \geq k^2 > 0$ for some real k . Then, by Theorem 14.4.10, any solution of $v'' + q(x)v = 0$ must have at least one zero between any two successive zeros of the solution $\sin kx$ of $u'' + k^2u = 0$. This means that any solution of $v'' + q(x)v = 0$ has a zero in any interval of length π/k if $q(x) \geq k^2 > 0$.

Let us apply this to the **Bessel DE**,

$$y'' + \frac{1}{x}y' + \left(1 - \frac{n^2}{x^2}\right)y = 0.$$

By Proposition 14.4.11, we can eliminate the y' term by substituting v/\sqrt{x} for y .⁵ This transforms the Bessel DE into

$$v'' + \left(1 - \frac{4n^2 - 1}{4x^2}\right)v = 0.$$

oscillation of the Bessel
function of order zero

We compare this, for $n = 0$, with $u'' + u = 0$, which has a solution $u = \sin x$, and conclude that each interval of length π of the positive x -axis contains at least one zero of any solution of order zero ($n = 0$) of the Bessel equation. Thus, in particular, the zeroth Bessel function, denoted by $J_0(x)$, has a zero in each interval of length π of the x -axis.

On the other hand, for $4n^2 - 1 > 0$, or $n > \frac{1}{2}$, we have $1 > [1 - (4n^2 - 1)/4x^2]$. This implies that $\sin x$ has *at least* one zero between any two successive zeros of the Bessel functions of order greater than $\frac{1}{2}$. It follows that such a Bessel function can have *at most* one zero between any two successive zeros of $\sin x$ (or in each interval of length π on the positive x -axis).

Example 14.4.14 Let us apply Corollary 14.4.12 to $v'' - v = 0$ in which $q(x) = -1 < 0$. According to the corollary, the most general solution, $c_1e^x + c_2e^{-x}$, can have at most one zero. Indeed,

$$c_1e^x + c_2e^{-x} = 0 \quad \Rightarrow \quad x = \frac{1}{2} \ln \left| -\frac{c_2}{c_1} \right|,$$

and this (real) x (if it exists) is the only possible solution, as predicted by the corollary.

⁵Because of the square root in the denominator, the range of x will have to be restricted to positive values.

14.5 Adjoint Differential Operators

We discussed adjoint operators in detail in the context of finite-dimensional vector spaces in Chap. 4. In particular, the importance of self-adjoint, or hermitian, operators was clearly spelled out by the spectral decomposition theorem of Chap. 6. A consequence of that theorem is the completeness of the eigenvectors of a hermitian operator, the fact that an arbitrary vector can be expressed as a linear combination of the (orthonormal) eigenvectors of a hermitian operator.

Self-adjoint differential operators are equally important because their “eigenfunctions” also form complete orthogonal sets, as we shall see later. This section generalizes the concept of the adjoint to the case of a differential operator (of second degree).

Definition 14.5.1 The HSOLDE

$$\mathbf{L}[y] \equiv p_2(x)y'' + p_1(x)y' + p_0(x)y = 0 \tag{14.17}$$

is said to be **exact** if

exact HSOLDE

$$\mathbf{L}[f] \equiv p_2(x)f'' + p_1(x)f' + p_0(x)f = \frac{d}{dx}[A(x)f' + B(x)f] \tag{14.18}$$

for all $f \in \mathcal{C}^2[a, b]$ and for some $A, B \in \mathcal{C}^1[a, b]$. An **integrating factor** for $\mathbf{L}[y]$ is a function $\mu(x)$ such that $\mu(x)\mathbf{L}[y]$ is exact.

integrating factor for HSOLDE

If the HSOLDE (14.17) is exact, then Eq. (14.18) gives

$$\frac{d}{dx}[A(x)y' + B(x)y] = 0 \Rightarrow A(x)y' + B(x)y = C,$$

a FOLDE with a constant inhomogeneous term.

If (14.17) has an integrating factor, then even the ISOLDE corresponding to it can be solved, because

$$\begin{aligned} \mu(x)\mathbf{L}[y] = \mu(x)r(x) &\Rightarrow \frac{d}{dx}[A(x)y' + B(x)y] = \mu(x)r(x) \\ &\Rightarrow A(x)y' + B(x)y = \int_{\alpha}^x \mu(t)r(t) dt, \end{aligned}$$

which is a general FOLDE. Thus, the existence of an integrating factor completely solves a SOLDE. It is therefore important to know whether or not a SOLDE admits an integrating factor. First let us give a criterion for the *exactness* of a SOLDE.

Proposition 14.5.2 *The HSOLDE of Eq. (14.17) is exact if and only if $p_2'' - p_1' + p_0 = 0$.*

Proof If the HSOLDE is exact, then Eq. (14.18) holds for all f , implying that $p_2 = A$, $p_1 = A' + B$, and $p_0 = B'$. It follows that $p_2'' = A''$, $p_1' = A'' + B'$, and $p_0 = B'$, which in turn give $p_2'' - p_1' + p_0 = 0$.

Conversely if $p_2'' - p_1' + p_0 = 0$, then, substituting $p_0 = -p_2'' + p_1'$ in the LHS of Eq. (14.17), we obtain

$$\begin{aligned} p_2 y'' + p_1 y' + p_0 y &= p_2 y'' + p_1 y' + (-p_2'' + p_1') y \\ &= p_2 y'' - p_2'' y + (p_1 y)' = (p_2 y' - p_2' y)' + (p_1 y)' \\ &= \frac{d}{dx} (p_2 y' - p_2' y + p_1 y), \end{aligned}$$

and the DE is exact. \square

A general HSOLDE is clearly not exact. Can we make it exact by multiplying it by an integrating factor? The following proposition contains the answer.

Proposition 14.5.3 *A function μ is an integrating factor of the HSOLDE of Eq. (14.17) if and only if it is a solution of the HSOLDE*

$$\mathbf{M}[\mu] \equiv (p_2 \mu)'' - (p_1 \mu)' + p_0 \mu = 0. \quad (14.19)$$

Proof This is an immediate consequence of Proposition 14.5.2. \square

We can expand Eq. (14.19) to obtain the equivalent equation

$$p_2 \mu'' + (2p_2' - p_1) \mu' + (p_2'' - p_1' + p_0) \mu = 0. \quad (14.20)$$

adjoint of a
second-order linear
differential operator

The operator \mathbf{M} given by

$$\mathbf{M} \equiv p_2 \frac{d^2}{dx^2} + (2p_2' - p_1) \frac{d}{dx} + (p_2'' - p_1' + p_0) \quad (14.21)$$

is called the **adjoint** of the operator \mathbf{L} and denoted by $\mathbf{M} \equiv \mathbf{L}^\dagger$. The reason for the use of the word “adjoint” will be made clear below.

Proposition 14.5.3 confirms the existence of an integrating factor. However, the latter can be obtained only by solving Eq. (14.20), which is at least as difficult as solving the original differential equation! In contrast, the integrating factor for a FOLDE can be obtained by a mere integration [$\mu(x)$ given in Eq. (14.8) is an integrating factor of the FOLDE (14.6), as the reader can verify].

Although integrating factors for SOLDEs are not as useful as their counterparts for FOLDEs, they can facilitate the study of SOLDEs. Let us first note that the adjoint of the adjoint of a differential operator is the original operator: $(\mathbf{L}^\dagger)^\dagger = \mathbf{L}$ (see Problem 14.13). This suggests that if v is an integrating factor of $\mathbf{L}[u]$, then u will be an integrating factor of $\mathbf{M}[v] \equiv \mathbf{L}^\dagger[v]$. In particular, multiplying the first one by v and the second one by u and subtracting the results, we obtain [see Equations (14.17) and (14.19)] $v\mathbf{L}[u] - u\mathbf{M}[v] = (vp_2)u'' - u(p_2v)'' + (vp_1)u' + u(p_1v)'$, which can be simplified to

$$v\mathbf{L}[u] - u\mathbf{M}[v] = \frac{d}{dx} [p_2 v u' - (p_2 v)' u + p_1 u v]. \quad (14.22)$$

Integrating this from a to b yields

$$\int_a^b (v\mathbf{L}[u] - u\mathbf{M}[v]) dx = [p_2vu' - (p_2v)'u + p_1uv] \Big|_a^b. \quad (14.23)$$

Equations (14.22) and (14.23) are called the **Lagrange identities**. Equation (14.23) embodies the reason for calling \mathbf{M} the adjoint of \mathbf{L} : If we consider u and v as abstract vectors $|u\rangle$ and $|v\rangle$, \mathbf{L} and \mathbf{M} as operators in a Hilbert space with the inner product $\langle u|v\rangle = \int_a^b u^*(x)v(x) dx$, then Eq. (14.23) can be written as

$$\langle v|\mathbf{L}|u\rangle - \langle u|\mathbf{M}|v\rangle = \langle u|\mathbf{L}^\dagger|v\rangle^* - \langle u|\mathbf{M}|v\rangle = [p_2vu' - (p_2v)'u + p_1uv] \Big|_a^b.$$

If the RHS is zero, then $\langle u|\mathbf{L}^\dagger|v\rangle^* = \langle u|\mathbf{M}|v\rangle$ for all $|u\rangle, |v\rangle$, and since all these operators and functions are real, $\mathbf{L}^\dagger = \mathbf{M}$.

As in the case of finite-dimensional vector spaces, a self-adjoint differential operator merits special consideration. For $\mathbf{M}[v] \equiv \mathbf{L}^\dagger[v]$ to be equal to \mathbf{L} , we must have [see Eqs. (14.17) and (14.20)] $2p_2' - p_1 = p_1$ and $p_2'' - p_1' + p_0 = p_0$. The first equation gives $p_2' = p_1$, which also solves the second equation. If this condition holds, then we can write Eq. (14.17) as $\mathbf{L}[y] = p_2y'' + p_2'y' + p_0y$, or

$$\mathbf{L}[y] = \frac{d}{dx} \left[p_2(x) \frac{dy}{dx} \right] + p_0(x)y = 0.$$

Can we make all SOLDEs self-adjoint? Let us multiply both sides of Eq. (14.17) by a function $h(x)$, to be determined later. We get the new DE

$$h(x)p_2(x)y'' + h(x)p_1(x)y' + h(x)p_0(x)y = 0,$$

which we desire to be self-adjoint. This will be accomplished if we choose $h(x)$ such that $hp_1 = (hp_2)'$, or $p_2h' + h(p_2' - p_1) = 0$, which can be readily integrated to give

$$h(x) = \frac{1}{p_2} \exp \left[\int^x \frac{p_1(t)}{p_2(t)} dt \right].$$

We have just proved the following:

Theorem 14.5.4 *The SOLDE of Eq. (14.17) is self-adjoint if and only if $p_2' = p_1$, in which case the DE has the form* all SOLDEs can be made self-adjoint

$$\frac{d}{dx} \left[p_2(x) \frac{dy}{dx} \right] + p_0(x)y = 0.$$

If it is not self-adjoint, it can be made so by multiplying it through by

$$h(x) = \frac{1}{p_2} \exp \left[\int^x \frac{p_1(t)}{p_2(t)} dt \right].$$

Example 14.5.5 (a) The Legendre equation in normal form,

$$y'' - \frac{2x}{1-x^2}y' + \frac{\lambda}{1-x^2}y = 0,$$

is not self-adjoint. However, if we multiply through by $h(x) = 1 - x^2$, we get

$$(1-x^2)y'' - 2xy' + \lambda y = 0,$$

which can be rewritten as $[(1-x^2)y']' + \lambda y = 0$, which is self-adjoint.

(b) Similarly, the normal form of the Bessel equation

$$y'' + \frac{1}{x}y' + \left(1 - \frac{n^2}{x^2}\right)y = 0$$

is not self-adjoint, but multiplying through by $h(x) = x$ yields

$$\frac{d}{dx}\left(x\frac{dy}{dx}\right) + \left(x - \frac{n^2}{x}\right)y = 0,$$

which is clearly self-adjoint.

14.6 Power-Series Solutions of SOLDEs

Analysis is one of the richest branches of mathematics, focusing on the endless variety of objects we call functions. The simplest kind of function is a polynomial, which is obtained by performing the simple algebraic operations of addition and multiplication on the independent variable x . The next in complexity are the trigonometric functions, which are obtained by taking ratios of geometric objects. If we demand a simplistic, intuitive approach to functions, the list ends there. It was only with the advent of derivatives, integrals, and differential equations that a vastly rich variety of functions exploded into existence in the eighteenth and nineteenth centuries. For instance, e^x , nonexistent before the invention of calculus, can be thought of as the function that solves $dy/dx = y$.

Although the definition of a function in terms of DEs and integrals seems a bit artificial, for most applications it is the only way to define a function. For instance, the **error function**, used in statistics, is defined as

$$\operatorname{erf}(x) \equiv \frac{1}{\sqrt{\pi}} \int_{-\infty}^x e^{-t^2} dt.$$

Such a function cannot be expressed in terms of elementary functions. Similarly, functions (of x) such as

$$\int_x^\infty \frac{\sin t}{t} dt, \quad \int_0^{\pi/2} \sqrt{1-x^2 \sin^2 t} dt, \quad \int_0^{\pi/2} \frac{dt}{\sqrt{1-x^2 \sin^2 t}},$$

and so on are encountered frequently in applications. None of these functions can be expressed in terms of other well-known functions.

An effective way of studying such functions is to study the differential equations they satisfy. In fact, the majority of functions encountered in mathematical physics obey the HSOLDE of Eq. (14.17) in which the $p_i(x)$ are elementary functions, mostly ratios of polynomials (of degree at most 2). Of course, to specify functions completely, appropriate boundary conditions are necessary. For instance, the error function mentioned above satisfies the HSOLDE $y'' + 2xy' = 0$ with the boundary conditions $y(0) = \frac{1}{2}$ and $y'(0) = 1/\sqrt{\pi}$.

The natural tendency to resist the idea of a function as a solution of a SOLDE is mostly due to the abstract nature of differential equations. After all, it is easier to imagine constructing functions by simple multiplications or with simple geometric figures that have been around for centuries. The following beautiful example (see [Birk 78, pp. 85–87]) should overcome this resistance and convince the skeptic that differential equations contain all the information about a function.

Example 14.6.1 (Trigonometric functions as solutions of DEs) We can show that the solutions to $y'' + y = 0$ have all the properties we expect of $\sin x$ and $\cos x$. Let us denote the two linearly independent solutions of this equation by $C(x)$ and $S(x)$. To specify these functions completely, we set $C(0) = S'(0) = 1$, and $C'(0) = S(0) = 0$. We claim that this information is enough to identify $C(x)$ and $S(x)$ as $\cos x$ and $\sin x$, respectively.

First, let us show that the solutions exist and are well-behaved functions. With $C(0)$ and $C'(0)$ given, the equation $y'' + y = 0$ can generate all derivatives of $C(x)$ at zero: $C''(0) = -C(0) = -1$, $C'''(0) = -C'(0) = 0$, $C^{(4)}(0) = -C''(0) = +1$, and, in general,

$$C^{(n)}(0) = \begin{cases} 0 & \text{if } n \text{ is odd,} \\ (-1)^k & \text{if } n = 2k \text{ where } k = 0, 1, 2, \dots \end{cases}$$

Thus, the Taylor expansion of $C(x)$ is

$$C(x) = \sum_{k=0}^{\infty} (-1)^k \frac{x^{2k}}{(2k)!}. \quad (14.24)$$

Similarly,

$$S(x) = \sum_{k=0}^{\infty} (-1)^k \frac{x^{2k+1}}{(2k+1)!}. \quad (14.25)$$

A simple ratio test on the series representation of $C(x)$ yields

$$\begin{aligned} \lim_{k \rightarrow \infty} \frac{a_{k+1}}{a_k} &= \lim_{k \rightarrow \infty} \frac{(-1)^{k+1} x^{2(k+1)} / (2k+2)!}{(-1)^k x^{2k} / (2k)!} \\ &= \lim_{k \rightarrow \infty} \frac{-x^2}{(2k+2)(2k+1)} = 0, \end{aligned}$$

which shows that the series for $C(x)$ converges for all values of x . Similarly, the series for $S(x)$ is also convergent. Thus, we are dealing with well-defined finite-valued functions.

This example illustrates that all information about sine and cosine is hidden in their differential equation.

Let us now enumerate and prove some properties of $C(x)$ and $S(x)$.

(a) $C'(x) = -S(x)$.

We prove this relation by differentiating $C''(x) + C(x) = 0$ and writing the result as $[C'(x)]' + C'(x) = 0$ to make evident the fact that $C'(x)$ is also a solution. Since $C'(0) = 0$ and $[C'(0)]' = C''(0) = -1$, and since $-S(x)$ satisfies the same initial conditions, the uniqueness theorem implies that $C'(x) = -S(x)$. Similarly, $S'(x) = C(x)$.

(b) $C^2(x) + S^2(x) = 1$.

Since the $p(x)$ term is absent from the SOLDE, Proposition 14.4.2 implies that the Wronskian of $C(x)$ and $S(x)$ is constant. On the other hand,

$$\begin{aligned} W(C, S; x) &= C(x)S'(x) - C'(x)S(x) = C^2(x) + S^2(x) \\ &= W(C, S; 0) = C^2(0) + S^2(0) = 1. \end{aligned}$$

(c) $S(a+x) = S(a)C(x) + C(a)S(x)$.

The use of the chain rule easily shows that $S(a+x)$ is a solution of the equation $y'' + y = 0$. Thus, it can be written as a linear combination of $C(x)$ and $S(x)$ [which are linearly independent because their Wronskian is nonzero by (b)]:

$$S(a+x) = AS(x) + BC(x). \quad (14.26)$$

This is a functional identity, which for $x = 0$ gives $S(a) = BC(0) = B$. If we differentiate both sides of Eq. (14.26), we get

$$C(a+x) = AS'(x) + BC'(x) = AC(x) - BS(x),$$

which for $x = 0$ gives $C(a) = A$. Substituting the values of A and B in Eq. (14.26) yields the desired identity. A similar argument leads to

$$C(a+x) = C(a)C(x) - S(a)S(x).$$

(d) Periodicity of $C(x)$ and $S(x)$.

Let x_0 be the smallest positive real number such that $S(x_0) = C(x_0)$. Then property (b) implies that $C(x_0) = S(x_0) = 1/\sqrt{2}$. On the other hand,

$$\begin{aligned} S(x_0+x) &= S(x_0)C(x) + C(x_0)S(x) = C(x_0)C(x) + S(x_0)S(x) \\ &= C(x_0)C(x) - S(x_0)S(-x) = C(x_0-x). \end{aligned}$$

The third equality follows because by Eq. (14.25), $S(x)$ is an odd function of x . This is true for all x ; in particular, for $x = x_0$ it yields $S(2x_0) = C(0) = 1$, and by property (b), $C(2x_0) = 0$. Using property (c) once more, we get

$$\begin{aligned} S(2x_0+x) &= S(2x_0)C(x) + C(2x_0)S(x) = C(x), \\ C(2x_0+x) &= C(2x_0)C(x) - S(2x_0)S(x) = -S(x). \end{aligned}$$

Substituting $x = 2x_0$ yields $S(4x_0) = C(2x_0) = 0$ and $C(4x_0) = -S(2x_0) = -1$. Continuing in this manner, we can easily obtain

$$S(8x_0 + x) = S(x), \quad C(8x_0 + x) = C(x),$$

which prove the periodicity of $S(x)$ and $C(x)$ and show that their period is $8x_0$. It is even possible to determine x_0 . This determination is left as a problem, but the result is

$$x_0 = \int_0^{1/\sqrt{2}} \frac{dt}{\sqrt{1-t^2}}.$$

A numerical calculation will show that this is $\pi/4$.

14.6.1 Frobenius Method of Undetermined Coefficients

A proper treatment of SOLDEs requires the medium of complex analysis and will be undertaken in the next chapter. At this point, however, we are seeking a *formal* infinite series solution to the SOLDE

$$y'' + p(x)y' + q(x)y = 0,$$

where $p(x)$ and $q(x)$ are real and analytic. This means that $p(x)$ and $q(x)$ can be represented by convergent power series in some interval (a, b) . [The interesting case where $p(x)$ and $q(x)$ may have singularities will be treated in the context of complex solutions.]

The general procedure is to write the expansions⁶

$$p(x) = \sum_{k=0}^{\infty} a_k x^k, \quad q(x) = \sum_{k=0}^{\infty} b_k x^k, \quad y = \sum_{k=0}^{\infty} c_k x^k \quad (14.27)$$

for the coefficient functions p and q and the solution y , substitute them in the SOLDE, and equate the coefficient of each power of x to zero. For this purpose, we need expansions for derivatives of y :

$$y' = \sum_{k=1}^{\infty} k c_k x^{k-1} = \sum_{k=0}^{\infty} (k+1) c_{k+1} x^k,$$

$$y'' = \sum_{k=1}^{\infty} (k+1) k c_{k+1} x^{k-1} = \sum_{k=0}^{\infty} (k+2)(k+1) c_{k+2} x^k.$$

⁶Here we are expanding about the origin. If such an expansion is impossible or inconvenient, one can expand about another point, say x_0 . One would then replace all powers of x in all expressions below with powers of $x - x_0$. These expansions assume that p , q , and y have no singularity at $x = 0$. In general, this assumption is not valid, and a different approach, in which the whole series is multiplied by a (not necessarily positive integer) power of x , ought to be taken. Details are provided in Chap. 15.

Thus

$$p(x)y' = \sum_{k=0}^{\infty} \sum_{m=0}^{\infty} a_m x^m (k+1)c_{k+1} x^k = \sum_{k,m} (k+1)a_m c_{k+1} x^{k+m}.$$

Let $k+m \equiv n$ and sum over n . Then the other sum, say m , cannot exceed n . Thus,

$$p(x)y' = \sum_{n=0}^{\infty} \sum_{m=0}^n (n-m+1)a_m c_{n-m+1} x^n.$$

Similarly, $q(x)y = \sum_{n=0}^{\infty} \sum_{m=0}^n b_m c_{n-m} x^n$. Substituting these sums and the series for y'' in the SOLDE, we obtain

$$\sum_{n=0}^{\infty} \left\{ (n+1)(n+2)c_{n+2} + \sum_{m=0}^n [(n-m+1)a_m c_{n-m+1} + b_m c_{n-m}] \right\} x^n = 0.$$

For this to be true for all x , the coefficient of each power of x must vanish:

$$(n+1)(n+2)c_{n+2} = - \sum_{m=0}^n [(n-m+1)a_m c_{n-m+1} + b_m c_{n-m}] \quad \text{for } n \geq 0,$$

or

$$n(n+1)c_{n+1} = - \sum_{m=0}^{n-1} [(n-m)a_m c_{n-m} + b_m c_{n-m-1}] \quad \text{for } n \geq 1. \quad (14.28)$$

If we know c_0 and c_1 (for instance from boundary conditions), we can uniquely determine c_n for $n \geq 2$ from Eq. (14.28). This, in turn, gives a unique power-series expansion for y , and we have the following theorem.

existence theorem for SOLDE **Theorem 14.6.2** (Existence) *For any SOLDE of the form $y'' + p(x)y' + q(x)y = 0$ with analytic coefficient functions given by the first two equations of (14.27), there exists a unique power series, given by the third equation of (14.27) that formally satisfies the SOLDE for each choice of c_0 and c_1 .*

This theorem merely states the existence of a formal power series and says nothing about its convergence. The following example will demonstrate that convergence is not necessarily guaranteed.

Example 14.6.3 The formal power-series solution for $x^2 y' - y + x = 0$ can be obtained by letting $y = \sum_{n=0}^{\infty} c_n x^n$. Then $y' = \sum_{n=0}^{\infty} (n+1)c_{n+1} x^n$, and substitution in the DE gives

$$\sum_{n=0}^{\infty} (n+1)c_{n+1} x^{n+2} - \sum_{n=0}^{\infty} c_n x^n + x = 0,$$

or

$$\sum_{n=0}^{\infty} (n+1)c_{n+1} x^{n+2} - c_0 - c_1 x - \sum_{n=2}^{\infty} c_n x^n + x = 0.$$

We see that $c_0 = 0$, $c_1 = 1$, and $(n + 1)c_{n+1} = c_{n+2}$ for $n \geq 0$. Thus, we have the recursion relation $nc_n = c_{n+1}$ for $n \geq 1$ whose unique solution is $c_n = (n - 1)!$, which generates the following solution for the DE:

$$y = x + x^2 + (2!)x^3 + (3!)x^4 + \cdots + (n - 1)!x^n + \cdots .$$

This series is not convergent for any nonzero x .

The SOLDE solved in the preceding example is not normal. However, for *normal* SOLDEs, the power series of y in Eq. (14.27) converges to an analytic function, as the following theorem shows (for a proof, see [Birk 78, p. 95]):

Theorem 14.6.4 For any choice of c_0 and c_1 , the radius of convergence of any power series solution $y = \sum_{k=0}^{\infty} c_k x^k$ for the normal HSOLDE

$$y'' + p(x)y' + q(x)y = 0$$

whose coefficients satisfy the recursion relation of (14.28) is at least as large as the smaller of the two radii of convergence of the two series for $p(x)$ and $q(x)$.

In particular, if $p(x)$ and $q(x)$ are analytic in an interval around $x = 0$, then the solution of the normal HSOLDE is also analytic in a neighborhood of $x = 0$.

Example 14.6.5 As an application of Theorem 14.6.2, let us consider the Legendre equation in its normal form

$$y'' - \frac{2x}{1-x^2}y' + \frac{\lambda}{1-x^2}y = 0.$$

For $|x| < 1$ both p and q are analytic, and

$$p(x) = -2x \sum_{m=0}^{\infty} (x^2)^m = \sum_{m=0}^{\infty} (-2)x^{2m+1},$$

$$q(x) = \lambda \sum_{m=0}^{\infty} (x^2)^m = \sum_{m=0}^{\infty} \lambda x^{2m}.$$

Thus, the coefficients of Eq. (14.27) are

$$a_m = \begin{cases} 0 & \text{if } m \text{ is even,} \\ -2 & \text{if } m \text{ is odd} \end{cases} \quad \text{and} \quad b_m = \begin{cases} \lambda & \text{if } m \text{ is even,} \\ 0 & \text{if } m \text{ is odd.} \end{cases}$$

We want to substitute for a_m and b_m in Eq. (14.28) to find c_{n+1} . It is convenient to consider two cases: when n is odd and when n is even. For $n = 2r + 1$, Eq. (14.28)—after some algebra—yields

$$(2r + 1)(2r + 2)c_{2r+2} = \sum_{m=0}^r (4r - 4m - \lambda)c_{2(r-m)}. \quad (14.29)$$

With $r \rightarrow r + 1$, this becomes

$$\begin{aligned}
 & (2r + 3)(2r + 4)c_{2r+4} \\
 &= \sum_{m=0}^{r+1} (4r + 4 - 4m - \lambda)c_{2(r+1-m)} \\
 &= (4r + 4 - \lambda)c_{2(r+1)} + \sum_{m=1}^{r+1} (4r + 4 - 4m - \lambda)c_{2(r+1-m)} \\
 &= (4r + 4 - \lambda)c_{2r+2} + \sum_{m=0}^r (4r - 4m - \lambda)c_{2(r-m)} \\
 &= (4r + 4 - \lambda)c_{2r+2} + (2r + 1)(2r + 2)c_{2r+2} \\
 &= [-\lambda + (2r + 3)(2r + 2)]c_{2r+2},
 \end{aligned}$$

where in going from the second equality to the third we changed the dummy index, and in going from the third equality to the fourth we used Eq. (14.29). Now we let $2r + 2 \equiv k$ to obtain $(k + 1)(k + 2)c_{k+2} = [k(k + 1) - \lambda]c_k$, or

$$c_{k+2} = \frac{k(k + 1) - \lambda}{(k + 1)(k + 2)}c_k \quad \text{for even } k.$$

It is not difficult to show that starting with $n = 2r$, the case of even n , we obtain this same equation for odd k . Thus, we can write

$$c_{n+2} = \frac{n(n + 1) - \lambda}{(n + 1)(n + 2)}c_n. \quad (14.30)$$

For arbitrary c_0 and c_1 , we obtain two independent solutions, one of which has only even powers of x and the other only odd powers. The generalized ratio test (see [Hass 08, Chap. 5]) shows that the series is divergent for $x = \pm 1$ unless $\lambda = l(l + 1)$ for some positive integer l . In that case the infinite series becomes a polynomial, the Legendre polynomial encountered in Chap. 8.

Equation (14.30) could have been obtained by substituting Eq. (14.27) directly into the Legendre equation. The roundabout way to (14.30) taken here shows the generality of Eq. (14.28). With specific differential equations it is generally better to substitute (14.27) directly.

quantum harmonic
oscillator: power series
method

Example 14.6.6 We studied Hermite polynomials in Chap. 8 in the context of classical orthogonal polynomials. Let us see how they arise in physics.

The one-dimensional time-independent Schrodinger equation for a particle of mass m in a potential $V(x)$ is

$$-\frac{\hbar^2}{2m} \frac{d^2\psi}{dx^2} + V(x)\psi = E\psi,$$

where E is the total energy of the particle.

For a harmonic oscillator, $V(x) = \frac{1}{2}kx^2 \equiv \frac{1}{2}m\omega^2x^2$ and

$$\psi'' - \frac{m^2\omega^2}{\hbar^2}x^2\psi + \frac{2m}{\hbar^2}E\psi = 0.$$

Substituting $\psi(x) = H(x)\exp(-m\omega x^2/2\hbar)$ and then making the change of variables $x = (1/\sqrt{m\omega/\hbar})y$ yields

$$H'' - 2yH' + \lambda H = 0 \quad \text{where } \lambda = \frac{2E}{\hbar\omega} - 1. \quad (14.31)$$

This is the Hermite differential equation in normal form. We assume the expansion $H(y) = \sum_{n=0}^{\infty} c_n y^n$ which yields

$$H'(y) = \sum_{n=1}^{\infty} n c_n y^{n-1} = \sum_{n=0}^{\infty} (n+1) c_{n+1} y^n,$$

$$H''(y) = \sum_{n=1}^{\infty} n(n+1) c_{n+1} y^{n-1} = \sum_{n=0}^{\infty} (n+1)(n+2) c_{n+2} y^n.$$

Substituting in Eq. (14.31) gives

$$\sum_{n=0}^{\infty} [(n+1)(n+2)c_{n+2} + \lambda c_n] y^n - 2 \sum_{n=0}^{\infty} (n+1) c_{n+1} y^{n+1} = 0,$$

or

$$2c_2 + \lambda c_0 + \sum_{n=0}^{\infty} [(n+2)(n+3)c_{n+3} + \lambda c_{n+1} - 2(n+1)c_{n+1}] y^{n+1} = 0.$$

Setting the coefficients of powers of y equal to zero, we obtain

$$c_2 = -\frac{\lambda}{2}c_0,$$

$$c_{n+3} = \frac{2(n+1) - \lambda}{(n+2)(n+3)} c_{n+1} \quad \text{for } n \geq 0,$$

or, replacing n with $n-1$,

$$c_{n+2} = \frac{2n - \lambda}{(n+1)(n+2)} c_n, \quad n \geq 1. \quad (14.32)$$

The ratio test yields easily that the series is convergent for all values of y .

Thus, the infinite series whose coefficients obey the recursive relation in Eq. (14.32) converges for all y . However, if we demand that $\lim_{x \rightarrow \infty} \psi(x) = 0$, which is necessary on physical grounds, the series must be truncated. This happens only if $\lambda = 2l$ for some integer l (see Problem 14.22 and [Hass 08, Chap. 13]), and in that case we obtain a polynomial, the Hermite polynomial of order l . A consequence of such a truncation is the quantization of harmonic oscillator energy:

$$2l = \lambda = \frac{2E}{\hbar\omega} - 1 \quad \Rightarrow \quad E = \left(l + \frac{1}{2}\right)\hbar\omega.$$

Two solutions are generated from Eq. (14.32), one including only even powers and the other only odd powers. These are clearly linearly independent. Thus, knowledge of c_0 and c_1 determines the general solution of the HSOLDE of (14.31).

14.6.2 Quantum Harmonic Oscillator

The preceding two examples show how certain special functions used in mathematical physics are obtained in an analytic way, by solving a differential equation. We saw in Chap. 13 how to obtain spherical harmonics and Legendre polynomials by algebraic methods. It is instructive to solve the harmonic oscillator problem using algebraic methods.

The Hamiltonian of a one-dimensional harmonic oscillator is

$$\mathbf{H} = \frac{\mathbf{p}^2}{2m} + \frac{1}{2}m\omega^2 x^2,$$

where $\mathbf{p} = -i\hbar d/dx$ is the momentum operator. Let us find the eigenvectors and eigenvalues of \mathbf{H} .

We define the operators

$$\mathbf{a} \equiv \sqrt{\frac{m\omega}{2\hbar}}x + i\frac{\mathbf{p}}{\sqrt{2m\hbar\omega}} \quad \text{and} \quad \mathbf{a}^\dagger \equiv \sqrt{\frac{m\omega}{2\hbar}}x - i\frac{\mathbf{p}}{\sqrt{2m\hbar\omega}}.$$

Using the commutation relation $[x, \mathbf{p}] = i\hbar\mathbf{1}$, we can show that

$$[\mathbf{a}, \mathbf{a}^\dagger] = \mathbf{1} \quad \text{and} \quad \mathbf{H} = \hbar\omega\mathbf{a}^\dagger\mathbf{a} + \frac{1}{2}\hbar\omega\mathbf{1}. \quad (14.33)$$

Furthermore, one can readily show that

$$[\mathbf{H}, \mathbf{a}] = -\hbar\omega\mathbf{a}, \quad [\mathbf{H}, \mathbf{a}^\dagger] = \hbar\omega\mathbf{a}^\dagger. \quad (14.34)$$

Let $|\psi_E\rangle$ be the eigenvector corresponding to the eigenvalue E : $\mathbf{H}|\psi_E\rangle = E|\psi_E\rangle$, and note that Eq. (14.34) gives

$$\mathbf{H}\mathbf{a}|\psi_E\rangle = (\mathbf{a}\mathbf{H} - \hbar\omega\mathbf{a})|\psi_E\rangle = (E - \hbar\omega)\mathbf{a}|\psi_E\rangle$$

and

$$\mathbf{H}\mathbf{a}^\dagger|\psi_E\rangle = (E + \hbar\omega)\mathbf{a}^\dagger|\psi_E\rangle.$$

Thus, $\mathbf{a}|\psi_E\rangle$ is an eigenvector of \mathbf{H} , with eigenvalue $E - \hbar\omega$, and $\mathbf{a}^\dagger|\psi_E\rangle$ is an eigenvector with eigenvalue $E + \hbar\omega$. That is why \mathbf{a}^\dagger and \mathbf{a} are called the **raising** and **lowering** (or creation and annihilation) **operators**, respectively. We can write

$$\mathbf{a}|\psi_E\rangle = c_E|\psi_{E-\hbar\omega}\rangle.$$

By applying \mathbf{a} repeatedly, we obtain states of lower and lower energies. But there is a limit to this because \mathbf{H} is a positive operator: It cannot have a negative eigenvalue. Thus, there must exist a **ground state**, $|\psi_0\rangle$, such that

$\mathbf{a}|\psi_0\rangle = 0$. The energy of this ground state (or the eigenvalue corresponding to $|\psi_0\rangle$) can be obtained:⁷

$$\mathbf{H}|\psi_0\rangle = \left(\hbar\omega\mathbf{a}^\dagger\mathbf{a} + \frac{1}{2}\hbar\omega\right)|\psi_0\rangle = \frac{1}{2}\hbar\omega|\psi_0\rangle.$$

Repeated application of the raising operator yields both higher-level states and eigenvalues. We thus define $|\psi_n\rangle$ by

$$(\mathbf{a}^\dagger)^n|\psi_0\rangle = c_n|\psi_n\rangle, \quad (14.35)$$

where c_n is a normalizing constant. The energy of $|\psi_n\rangle$ is n units higher than the ground state's, or

$$E_n = \left(n + \frac{1}{2}\right)\hbar\omega,$$

which is what we obtained in the preceding example.

To find c_n , we demand orthonormality for the $|\psi_n\rangle$. Taking the inner product of (14.35) with itself, we can show (see Problem 14.23) that

$$|c_n|^2 = n|c_{n-1}|^2 \Rightarrow |c_n|^2 = n!|c_0|^2,$$

which for $|c_0| = 1$ and real c_n yields $c_n = \sqrt{n!}$. It follows, then, that

$$|\psi_n\rangle = \frac{1}{\sqrt{n!}}(\mathbf{a}^\dagger)^n|\psi_0\rangle. \quad (14.36)$$

In terms of functions and derivative operators, $\mathbf{a}|\psi_0\rangle = 0$ gives

$$\left(\sqrt{\frac{m\omega}{2\hbar}}x + \sqrt{\frac{\hbar}{2m\omega}}\frac{d}{dx}\right)\psi_0(x) = 0$$

with the solution $\psi_0(x) = c \exp(-m\omega x^2/2\hbar)$. Normalizing $\psi_0(x)$ gives

$$1 = \langle\psi_0|\psi_0\rangle = c^2 \int_{-\infty}^{\infty} \exp\left(-\frac{m\omega x^2}{\hbar}\right) dx = c^2 \left(\frac{\hbar\pi}{m\omega}\right)^{1/2}.$$

Thus,

$$\psi_0(x) = \left(\frac{m\omega}{\hbar\pi}\right)^{1/4} e^{-m\omega x^2/(2\hbar)}.$$

We can now write Eq. (14.36) in terms of differential operators:

$$\psi_n(x) = \frac{1}{\sqrt{n!}} \left(\frac{m\omega}{\hbar\pi}\right)^{1/4} \left(\sqrt{\frac{m\omega}{2\hbar}}x - \sqrt{\frac{\hbar}{2m\omega}}\frac{d}{dx}\right)^n e^{-m\omega x^2/(2\hbar)}.$$

Defining a new variable $y = \sqrt{m\omega/\hbar}x$ transforms this equation into

$$\psi_n = \left(\frac{m\omega}{\hbar\pi}\right)^{1/4} \frac{1}{\sqrt{2^n n!}} \left(y - \frac{d}{dy}\right)^n e^{-y^2/2}.$$

⁷From here on, the unit operator $\mathbf{1}$ will not be shown explicitly.

quantum harmonic oscillator: connection between algebraic and analytic methods

From this, the relation between Hermite polynomials, and the solutions of the one-dimensional harmonic oscillator as given in the previous example, we can obtain a general formula for $H_n(x)$. In particular, if we note that (see Problem 14.23)

$$e^{y^2/2} \left(y - \frac{d}{dy} \right) e^{-y^2/2} = -e^{y^2} \frac{d}{dy} e^{-y^2}$$

and, in general,

$$e^{y^2/2} \left(y - \frac{d}{dy} \right)^n e^{-y^2/2} = (-1)^n e^{y^2} \frac{d^n}{dy^n} e^{-y^2},$$

we recover the generalized Rodriguez formula of Chap. 8 for Hermite polynomials.

14.7 SOLDEs with Constant Coefficients

The solution to a SOLDE with constant coefficients can always be found in closed form. In fact, we can treat an n th-order linear differential equation (NOLDE) with constant coefficients with no extra effort. This section outlines the procedure for solving such an equation. For details, the reader is referred to any elementary book on differential equations (see also [Hass 08]). The most general n th-order linear differential equation (NOLDE) with constant coefficients can be written as

$$\mathbf{L}[y] \equiv y^{(n)} + a_{n-1}y^{(n-1)} + \cdots + a_1y' + a_0y = r(x). \quad (14.37)$$

The corresponding homogeneous NOLDE (HNOLDE) has $r(x) = 0$. The solution to the HNOLDE

$$\mathbf{L}[y] \equiv y^{(n)} + a_{n-1}y^{(n-1)} + \cdots + a_1y' + a_0y = 0 \quad (14.38)$$

can be found by making the exponential substitution $y = e^{\lambda x}$, which results in the equation

$$\mathbf{L}[e^{\lambda x}] = (\lambda^n + a_{n-1}\lambda^{n-1} + \cdots + a_1\lambda + a_0)e^{\lambda x} = 0.$$

characteristic
polynomial of an
HNOLDE

This equation will hold only if λ is a root of the **characteristic polynomial**

$$p(\lambda) \equiv \lambda^n + a_{n-1}\lambda^{n-1} + \cdots + a_1\lambda + a_0,$$

which, by the fundamental theorem of algebra (Theorem 10.5.6), can be written as

$$p(\lambda) = (\lambda - \lambda_1)^{k_1} (\lambda - \lambda_2)^{k_2} \cdots (\lambda - \lambda_m)^{k_m}, \quad (14.39)$$

where λ_j is the distinct (complex) root of $p(\lambda)$ with multiplicity k_j .

Theorem 14.7.1 Let $\{\lambda_j\}_{j=1}^m$ be the distinct roots of the characteristic polynomial of the real HNOLDE of Eq. (14.38) with multiplicities $\{k_j\}_{j=1}^m$. Then the functions

$$\left\{ \left\{ x^{r_j} e^{\lambda_j x} \right\}_{r_j=0}^{k_j-1} \right\}_{j=1}^m \equiv \left\{ e^{\lambda_j x}, x e^{\lambda_j x}, \dots, x^{k_j-1} e^{\lambda_j x} \right\}_{j=1}^m$$

are a basis of solutions of Eq. (14.38).

When λ_i is complex, one can write its corresponding solution in terms of trigonometric functions.

Example 14.7.2 An equation that is used in both mechanics and circuit theory is

$$\frac{d^2 y}{dt^2} + a \frac{dy}{dt} + by = 0 \quad \text{for } a, b > 0. \quad (14.40)$$

Its characteristic polynomial is $p(\lambda) = \lambda^2 + a\lambda + b$, which has the roots

$$\lambda_1 = \frac{1}{2}(-a + \sqrt{a^2 - 4b}) \quad \text{and} \quad \lambda_2 = \frac{1}{2}(-a - \sqrt{a^2 - 4b}).$$

We can distinguish three different possible motions depending on the relative sizes of a and b .

- (a) $a^2 > 4b$ (overdamped): Here we have two distinct simple roots. The multiplicities are both one ($k_1 = k_2 = 1$); therefore, the power of x for both solutions is zero ($r_1 = r_2 = 0$). Let $\gamma \equiv \frac{1}{2}\sqrt{a^2 - 4b}$. Then the most general solution is overdamped oscillation

$$y(t) = e^{-at/2} (c_1 e^{\gamma t} + c_2 e^{-\gamma t}).$$

Since $a > 2\gamma$, this solution starts at $y = c_1 + c_2$ at $t = 0$ and continuously decreases; so, as $t \rightarrow \infty$, $y(t) \rightarrow 0$.

- (b) $a^2 = 4b$ (critically damped): In this case we have one multiple root of order 2 ($k_1 = 2$); therefore, the power of x can be zero or 1 ($r_1 = 0, 1$). Thus, the general solution is critically damped oscillation

$$y(t) = c_1 t e^{-at/2} + c_0 e^{-at/2}.$$

This solution starts at $y(0) = c_0$ at $t = 0$, reaches a maximum (or minimum) at $t = 2/a - c_0/c_1$, and subsequently decays (grows) exponentially to zero.

- (c) $a^2 < 4b$ (underdamped): Once more, we have two distinct simple roots. The multiplicities are both one ($k_1 = k_2 = 1$); therefore, the power of x for both solutions is zero ($r_1 = r_2 = 0$). Let $\omega \equiv \frac{1}{2}\sqrt{4b - a^2}$. Then $\lambda_1 = -a/2 + i\omega$ and $\lambda_2 = \lambda_1^*$. The roots are complex, and the most general solution is thus of the form underdamped oscillation

$$y(t) = e^{-at/2} (c_1 \cos \omega t + c_2 \sin \omega t) = A e^{-at/2} \cos(\omega t + \alpha).$$

The solution is a harmonic variation with a decaying amplitude $A \exp(-at/2)$. Note that if $a = 0$, the amplitude does not decay. That is why a is called the **damping factor** (or the damping constant).

These equations describe either a mechanical system oscillating (with no external force) in a viscous (dissipative) fluid, or an electrical circuit consisting of a resistance R , an inductance L , and a capacitance C . For RLC circuits, $a = R/L$ and $b = 1/(LC)$. Thus, the damping factor depends on the relative magnitudes of R and L . On the other hand, the frequency

$$\omega \equiv \sqrt{b - \left(\frac{a}{2}\right)^2} = \sqrt{\frac{1}{LC} - \frac{R^2}{4L^2}}$$

depends on all three elements. In particular, for $R \geq 2\sqrt{L/C}$ the circuit does not oscillate.

A physical system whose behavior in the absence of a driving force is described by a HNOLDE will obey an inhomogeneous NOLDE in the presence of the driving force. This driving force is simply the inhomogeneous term of the NOLDE. The best way to solve such an inhomogeneous NOLDE in its most general form is by using Fourier transforms and Green's functions, as we will do in Chap. 20. For the particular, but important, case in which the inhomogeneous term is a product of polynomials and exponentials, the solution can be found in closed form.

Theorem 14.7.3 *The INOLDE $\mathbf{L}[y] = e^{\lambda x} S(x)$, where $S(x)$ is a polynomial, has the particular solution $e^{\lambda x} q(x)$, where $q(x)$ is also a polynomial. The degree of $q(x)$ equals that of $S(x)$ unless $\lambda = \lambda_j$, a root of the characteristic polynomial of \mathbf{L} , in which case the degree of $q(x)$ exceeds that of $S(x)$ by k_j , the multiplicity of λ_j .*

Once we know the form of the particular solution of the NOLDE, we can find the coefficients in the polynomial of the solution by substituting in the NOLDE and matching the powers on both sides.

Example 14.7.4 Let us find the most general solutions for the following two differential equations subject to the boundary conditions $y(0) = 0$ and $y'(0) = 1$.

(a) The first DE we want to consider is

$$y'' + y = xe^x. \quad (14.41)$$

The characteristic polynomial is $\lambda^2 + 1$, whose roots are $\lambda_1 = i$ and $\lambda_2 = -i$. Thus, a basis of solutions is $\{\cos x, \sin x\}$. To find the particular solution we note that λ (the coefficient of x in the exponential part of the inhomogeneous term) is 1, which is neither of the roots λ_1 and λ_2 . Thus, the particular solution is of the form $q(x)e^x$, where $q(x) = Ax + B$ is of degree 1 [same degree as that of $S(x) = x$]. We now substitute $y = (Ax + B)e^x$ in Eq. (14.41) to obtain the relation

$$2Axe^x + (2A + 2B)e^x = xe^x.$$

Matching the coefficients, we have

$$2A = 1 \quad \text{and} \quad 2A + 2B = 0 \quad \Rightarrow \quad A = \frac{1}{2} = -B.$$

Thus, the most general solution is

$$y = c_1 \cos x + c_2 \sin x + \frac{1}{2}(x - 1)e^x.$$

Imposing the given boundary conditions yields $0 = y(0) = c_1 - \frac{1}{2}$ and $1 = y'(0) = c_2$. Thus,

$$y = \frac{1}{2} \cos x + \sin x + \frac{1}{2}(x - 1)e^x$$

is the unique solution.

(b) The next DE we want to consider is

$$y'' - y = xe^x. \quad (14.42)$$

Here $p(\lambda) = \lambda^2 - 1$, and the roots are $\lambda_1 = 1$ and $\lambda_2 = -1$. A basis of solutions is $\{e^x, e^{-x}\}$. To find a particular solution, we note that $S(x) = x$ and $\lambda = 1 = \lambda_1$. Theorem 14.7.3 then implies that $q(x)$ must be of degree 2, because λ_1 is a simple root, i.e., $k_1 = 1$. We therefore try

$$q(x) = Ax^2 + Bx + C \quad \Rightarrow \quad y = (Ax^2 + Bx + C)e^x.$$

Taking the derivatives and substituting in Eq. (14.42) yields two equations,

$$4A = 1 \quad \text{and} \quad A + B = 0,$$

whose solution is $A = -B = \frac{1}{4}$. Note that C is not determined, because Ce^x is a solution of the homogeneous DE corresponding to Eq. (14.42), so when \mathbf{L} is applied to y , it eliminates the term Ce^x . Another way of looking at the situation is to note that the most general solution to (14.42) is of the form

$$y = c_1 e^x + c_2 e^{-x} + \left(\frac{1}{4}x^2 - \frac{1}{4}x + C \right) e^x.$$

The term Ce^x could be absorbed in $c_1 e^x$. We therefore set $C = 0$, apply the boundary conditions, and find the unique solution

$$y = \frac{5}{4} \sinh x + \frac{1}{4}(x^2 - x)e^x.$$

14.8 The WKB Method

In this section, we treat the somewhat specialized method of obtaining an approximate solution to a particular type of second-order DE arising from the Schrödinger equation in one dimension. The method's name comes from Wentzel, Kramers, and Brillouin, who invented it and applied it for the first time.

Suppose we are interested in finding approximate solutions of the DE

$$\frac{d^2y}{dx^2} + q(x)y = 0 \quad (14.43)$$

in which q varies “slowly” with respect to x in the sense discussed below. If q varies infinitely slowly, i.e., if it is a constant, the solution to Eq. (14.43) is simply an imaginary exponential (or trigonometric). So, let us define $\phi(x)$ by $y = e^{i\phi(x)}$ and rewrite the DE as

$$(\phi')^2 + i\phi'' - q = 0. \quad (14.44)$$

Assuming that ϕ'' is small (compared to q), so that y does not oscillate too rapidly, we can find an approximate solution to the DE:

$$\phi' = \pm\sqrt{q} \Rightarrow \phi = \pm \int \sqrt{q(x)} dx. \quad (14.45)$$

The condition of validity of our assumption is obtained by differentiating (14.45):

$$|\phi''| \approx \frac{1}{2} \left| \frac{q'}{\sqrt{q}} \right| \ll |q|.$$

It follows from Eq. (14.45) and the definition of ϕ that $1/\sqrt{q}$ is approximately $1/(2\pi)$ times one “wavelength” of the solution y . Therefore, the approximation is valid if the change in q in one wavelength is small compared to $|q|$.

The approximation can be improved by inserting the derivative of (14.45) in the DE and solving for a new ϕ :

$$(\phi')^2 \approx q \pm \frac{i}{2} \frac{q'}{\sqrt{q}} \Rightarrow \phi' \approx \pm \left(q \pm \frac{i}{2} \frac{q'}{\sqrt{q}} \right)^{1/2},$$

or

$$\begin{aligned} \phi' &\approx \pm\sqrt{q} \left(1 \pm \frac{i}{2} \frac{q'}{q^{3/2}} \right)^{1/2} = \pm\sqrt{q} \left(1 \pm \frac{i}{4} \frac{q'}{q^{3/2}} \right) \\ &= \pm\sqrt{q} + \frac{i}{4} \frac{q'}{q} \Rightarrow \phi(x) \approx \pm \int \sqrt{q} dx + \frac{i}{4} \ln q. \end{aligned}$$

The two choices give rise to two different solutions, a linear combination of which gives the most general solution. Thus,

$$y \approx \frac{1}{\sqrt[4]{q(x)}} \left\{ c_1 \exp \left[i \int \sqrt{q} dx \right] + c_2 \exp \left[-i \int \sqrt{q} dx \right] \right\}. \quad (14.46)$$

Equation (14.46) gives an approximate solution to (14.43) in any region in which the condition of validity holds. The method fails if q changes too rapidly or if it is zero at some point of the region. The latter is a serious difficulty, since we often wish to join a solution in a region in which $q(x) > 0$ to one in a region in which $q(x) < 0$. There is a general procedure for deriving the so-called *connection formulas* relating the constants c_1 and c_2 of the two solutions on either side of the point where $q(x) = 0$. We shall not go into the details of such a derivation, as it is not particularly illuminating.⁸ We simply quote a particular result that is useful in applications.

connection formulas

Suppose that q passes through zero at x_0 , is positive to the right of x_0 , and satisfies the condition of validity in regions both to the right and to the left of x_0 . Furthermore, assume that the solution of the DE decreases exponentially to the left of x_0 . Under such conditions, the solution to the left will be of the form

$$\frac{1}{\sqrt[4]{-q(x)}} \exp\left[-\int_x^{x_0} \sqrt{-q(x)} dx\right], \quad (14.47)$$

while to the right, we have

$$2 \frac{1}{\sqrt[4]{q(x)}} \cos\left[\int_{x_0}^x \sqrt{q(x)} dx - \frac{\pi}{4}\right]. \quad (14.48)$$

A similar procedure gives connection formulas for the case where q is positive on the left and negative on the right of x_0 .

Example 14.8.1 Consider the Schrödinger equation in one dimension

$$\frac{d^2\psi}{dx^2} + \frac{2m}{\hbar^2}[E - V(x)]\psi = 0$$

where $V(x)$ is a potential well meeting the horizontal line of constant E at $x = a$ and $x = b$, so that

$$q(x) = \frac{2m}{\hbar^2}[E - V(x)] \begin{cases} > 0 & \text{if } a < x < b, \\ < 0 & \text{if } x < a \text{ or } x > b. \end{cases}$$

The solution that is bounded to the left of a must be exponentially decaying. Therefore, in the interval (a, b) the approximate solution, as given by Eq. (14.48), is

$$\psi(x) \approx \frac{A}{(E - V)^{1/4}} \cos\left(\int_a^x \sqrt{\frac{2m}{\hbar^2}[E - V(x)]} dx - \frac{\pi}{4}\right),$$

where A is some arbitrary constant. The solution that is bounded to the right of b must also be exponentially decaying. Hence, the solution for $a < x < b$ is

$$\psi(x) \approx \frac{B}{(E - V)^{1/4}} \cos\left(\int_x^b \sqrt{\frac{2m}{\hbar^2}[E - V(x)]} dx - \frac{\pi}{4}\right).$$

⁸The interested reader is referred to the book by Mathews and Walker, pp. 27–37.

Since these two expressions give the same function in the same region, they must be equal. Thus, $A = B$, and, more importantly,

$$\begin{aligned} & \cos\left(\int_a^x \sqrt{\frac{2m}{\hbar^2}[E - V(x)]} dx - \frac{\pi}{4}\right) \\ &= \cos\left(\int_x^b \sqrt{\frac{2m}{\hbar^2}[E - V(x)]} dx - \frac{\pi}{4}\right), \end{aligned}$$

or

$$\int_a^b \sqrt{2m[E - V(x)]} dx = \left(n + \frac{1}{2}\right)\pi\hbar.$$

Bohr-Sommerfeld quantization condition This is essentially the Bohr-Sommerfeld quantization condition of pre-1925 quantum mechanics.

14.8.1 Classical Limit of the Schrödinger Equation

As long as we are approximating solutions of second-order DEs that arise naturally from the Schrödinger equation, it is instructive to look at another approximation to the Schrödinger equation, its classical limit in which the Planck constant goes to zero.

The idea is to note that since $\psi(\mathbf{r}, t)$ is a complex function, one can write it as

$$\psi(\mathbf{r}, t) = A(\mathbf{r}, t) \exp\left[\frac{i}{\hbar}S(\mathbf{r}, t)\right], \quad (14.49)$$

where $A(\mathbf{r}, t)$ and $S(\mathbf{r}, t)$ are real-valued functions. Substituting (14.49) in the Schrödinger equation and separating the real and the imaginary parts yields

$$\begin{aligned} \frac{\partial S}{\partial t} + \frac{\nabla S \cdot \nabla S}{2m} + V &= \frac{\hbar^2}{2m} \frac{\nabla^2 A}{A}, \\ m \frac{\partial A}{\partial t} + \nabla S \cdot \nabla A + \frac{A}{2} \nabla^2 S &= 0. \end{aligned} \quad (14.50)$$

These two equations are completely equivalent to the Schrödinger equation. The second equation has a direct physical interpretation. Define

$$\rho(\mathbf{r}, t) \equiv A^2(\mathbf{r}, t) = |\psi(\mathbf{r}, t)|^2 \quad \text{and} \quad \mathbf{J}(\mathbf{r}, t) \equiv A^2(\mathbf{r}, t) \underbrace{\frac{\nabla S}{m}}_{\equiv \mathbf{v}} = \rho \mathbf{v}, \quad (14.51)$$

multiply the second equation in (14.50) by $2A/m$, and note that it then can be written as

$$\frac{\partial \rho}{\partial t} + \nabla \cdot \mathbf{J} = 0, \quad (14.52)$$

which is the continuity equation for probability. The fact that \mathbf{J} is indeed the probability current density is left for Problem 14.32.

The first equation of (14.50) gives an interesting result when $\hbar \rightarrow 0$ because in this limit, the RHS of the equation will be zero, and we get

$$\frac{\partial S}{\partial t} + \frac{1}{2}mv^2 + V = 0.$$

Taking the gradient of this equation, we obtain

$$\left(\frac{\partial}{\partial t} + \mathbf{v} \cdot \nabla\right)m\mathbf{v} + \nabla V = 0,$$

which is the equation of motion of a classical fluid with velocity field $\mathbf{v} = \nabla S/m$. We thus have the following:

Proposition 14.8.2 *In the classical limit, the solution of the Schrödinger equation describes a fluid (statistical mixture) of noninteracting classical particles of mass m subject to the potential $V(\mathbf{r})$. The density and the current density of this fluid are, respectively, the probability density $\rho = |\psi|^2$ and the probability current density \mathbf{J} of the quantum particle.*

Schrödinger equation describes a classical statistical mixture when $\hbar \rightarrow 0$.

14.9 Problems

14.1 Let $u(x)$ be a differentiable function satisfying the differential inequality $u'(x) \leq Ku(x)$ for $x \in [a, b]$, where K is a constant. Show that $u(x) \leq u(a)e^{K(x-a)}$. Hint: Multiply both sides of the inequality by e^{-Kx} , and show that the result can be written as the derivative of a nonincreasing function. Then use the fact that $a \leq x$ to get the final result.

14.2 Prove Proposition 14.4.2.

14.3 Let $f_1(x) = x$ and $f_2(x) = |x|$ for $x \in [-1, 1]$. Show that these two functions are linearly independent in the given interval, and that their Wronskian vanishes. Is this a violation of Theorem 14.4.3?

14.4 How would you generalize the Wronskian to n functions which have derivatives up to n th order? Prove that the Wronskian vanishes if the functions are linearly dependent.

14.5 Let f and g be two differentiable functions that are linearly dependent. Show that their Wronskian vanishes.

14.6 Show that if (f_1, f_1') and (f_2, f_2') are linearly dependent at one point, then f_1 and f_2 are linearly dependent at all $x \in [a, b]$. Here f_1 and f_2 are solutions of the DE of (14.12). Hint: Derive the identity

$$W(f_1, f_2; x_2) = W(f_1, f_2; x_1) \exp\left\{-\int_{x_1}^{x_2} p(t) dt\right\}.$$

14.7 Show that the solutions to the SOLDE $y'' + q(x)y = 0$ have a constant Wronskian.

14.8 Find (in terms of an integral) $G_n(x)$, the linearly independent “partner” of the Hermite polynomial $H_n(x)$. Specialize this to $n = 0, 1$. Is it possible to find $G_0(x)$ and $G_1(x)$ in terms of elementary functions?

14.9 Let f_1, f_2 , and f_3 be any three solutions of $y'' + py' + qy = 0$. Show that the (generalized 3×3) Wronskian of these solutions is zero. Thus, any three solutions of the HSOLDE are linearly dependent.

14.10 For the HSOLDE $y'' + py' + qy = 0$, show that

$$p = -\frac{f_1 f_2'' - f_2 f_1''}{W(f_1, f_2)} \quad \text{and} \quad q = \frac{f_1' f_2'' - f_2' f_1''}{W(f_1, f_2)}.$$

Thus, knowing two solutions of an HSOLDE allows us to reconstruct the DE.

14.11 Let f_1, f_2 , and f_3 be three solutions of the third-order linear differential equation $y''' + p_2(x)y'' + p_1(x)y' + p_0(x)y = 0$. Derive a FODE satisfied by the (generalized 3×3) Wronskian of these solutions.

14.12 Prove Corollary 14.4.12. Hint: Consider the solution $u = 1$ of the DE $u'' = 0$ and apply Theorem 14.4.10.

14.13 Show that the adjoint of \mathbf{M} given in Eq. (14.20) is the original \mathbf{L} .

14.14 Show that if $u(x)$ and $v(x)$ are solutions of the self-adjoint DE Abel's identity $(pu')' + qu = 0$, then **Abel's identity**, $p(uv' - vu') = \text{constant}$, holds.

14.15 Reduce each DE to self-adjoint form.

$$(a) \quad x^2 y'' + xy' + y = 0, \quad (b) \quad y'' + y' \tan x = 0.$$

14.16 Reduce the self-adjoint DE $(py')' + qy = 0$ to $u'' + S(x)u = 0$ by an appropriate change of the dependent variable. What is $S(x)$? Apply this reduction to the Legendre DE for $P_n(x)$, and show that

$$S(x) = \frac{1 + n(n+1) - n(n+1)x^2}{(1-x^2)^2}.$$

Now use this result to show that every solution of the Legendre equation has at least $(2n+1)/\pi$ zeros on $(-1, +1)$.

14.17 Substitute $v = y'/y$ in the *homogeneous* SOLDE

$$y'' + p(x)y' + q(x)y = 0$$

and:

- (a) Show that it turns into $v' + v^2 + p(x)v + q(x) = 0$, which is a first-order *nonlinear* equation called the **Riccati equation**. Would the same substitution work if the DE were inhomogeneous? Riccati equation
- (b) Show that by an appropriate transformation, the Riccati equation can be directly cast in the form $u' + u^2 + S(x) = 0$.

14.18 For the function $S(x)$ defined in Example 14.6.1, let $S^{-1}(x)$ be the inverse, i.e., $S^{-1}(S(x)) = x$. Show that

$$\frac{d}{dx}[S^{-1}(x)] = \frac{1}{\sqrt{1-x^2}},$$

and given that $S^{-1}(0) = 0$, conclude that

$$S^{-1}(x) = \int_0^x \frac{dt}{\sqrt{1-t^2}}.$$

14.19 Define $\sinh x$ and $\cosh x$ as the solutions of $y'' = y$ satisfying the boundary conditions $y(0) = 0$, $y'(0) = 1$ and $y(0) = 1$, $y'(0) = 0$, respectively. Using Example 14.6.1 as a guide, show that

- (a) $\cosh^2 x - \sinh^2 x = 1$,
- (b) $\cosh(-x) = \cosh x$,
- (c) $\sinh(-x) = -\sinh x$.
- (d) $\sinh(a+x) = \sinh a \cosh x + \cosh a \sinh x$.

14.20 For Example 14.6.5, derive

- (a) Equation (14.29), and
- (b) Equation (14.30) by direct substitution.
- (c) Let $\lambda = l(l+1)$ and calculate the Legendre polynomials $P_l(x)$ for $l = 0, 1, 2, 3$, subject to the condition $P_l(1) = 1$.

14.21 Use Eq. (14.32) of Example 14.6.6 to generate the first three Hermite polynomials. Use the normalization

$$\int_{-\infty}^{\infty} [H_n(x)]^2 e^{-x^2} dx = \sqrt{\pi} 2^n n!$$

to determine the arbitrary constant.

14.22 The function defined by

$$f(x) = \sum_{n=0}^{\infty} c_n x^n, \quad \text{where} \quad c_{n+2} = \frac{2n-\lambda}{(n+1)(n+2)} c_n,$$

can be written as $f(x) = c_0 g(x) + c_1 h(x)$, where g is even and h is odd in x . Show that $f(x)$ goes to infinity at least as fast as e^{x^2} does, i.e., $\lim_{x \rightarrow \infty} f(x)e^{-x^2} \neq 0$. Hint: Consider $g(x)$ and $h(x)$ separately and show

that

$$g(x) = \sum_{n=0}^{\infty} b_n x^n, \quad \text{where} \quad b_{n+1} = \frac{4n - \lambda}{(2n+1)(2n+2)} b_n.$$

Then concentrate on the ratio $g(x)/e^{x^2}$, where g and e^{x^2} are approximated by polynomials of very high degrees. Take the limit of this ratio as $x \rightarrow \infty$, and use recursion relations for g and e^{x^2} . The odd case follows similarly.

14.23 Refer to Sect. 14.6.2 for this problem.

- Derive the commutation relation $[\mathbf{a}, \mathbf{a}^\dagger] = \mathbf{1}$.
- Show that the Hamiltonian can be written as given in Eq. (14.33).
- Derive the commutation relation $[\mathbf{a}, (\mathbf{a}^\dagger)^n] = n(\mathbf{a}^\dagger)^{n-1}$.
- Take the inner product of Eq. (14.35) with itself and use (c) to show that $|c_n|^2 = n|c_{n-1}|^2$. From this, conclude that $|c_n|^2 = n!|c_0|^2$.
- For any function $f(y)$, show that

$$\left(y - \frac{d}{dy}\right) (e^{y^2/2} f) = -e^{y^2/2} \frac{df}{dy}.$$

Apply $(y - d/dy)$ repeatedly to both sides of the above equation to obtain

$$\left(y - \frac{d}{dy}\right)^n (e^{y^2/2} f) = (-1)^n e^{y^2/2} \frac{d^n f}{dy^n}.$$

- Choose an appropriate $f(y)$ in part (e) and show that

$$e^{y^2/2} \left(y - \frac{d}{dy}\right)^n e^{-y^2/2} = (-1)^n e^{y^2/2} \frac{d^n}{dy^n} (e^{-y^2}).$$

Airy's DE 14.24 Solve **Airy's DE**, $y'' + xy = 0$, by the power-series method. Show that the radius of convergence for both independent solutions is infinite. Use the comparison theorem to show that for $x > 0$ these solutions have infinitely many zeros, but for $x < 0$ they can have at most one zero.

14.25 Show that the functions $x^r e^{\lambda x}$, where $r = 0, 1, 2, \dots, k$, are linearly independent. Hint: Apply appropriate powers of $\mathbf{D} - \lambda$ to a linear combination of $x^r e^{\lambda x}$ for all possible r 's.

14.26 Find a basis of real solutions for each DE.

- $y'' + 5y' + 6 = 0$,
- $y''' + 6y'' + 12y' + 8y = 0$,
- $\frac{d^4 y}{dx^4} = y$,
- $\frac{d^4 y}{dx^4} = -y$.

14.27 Solve the following initial value problems.

- $\frac{d^4 y}{dx^4} = y$, $y(0) = y'(0) = y''(0) = 0$, $y'''(0) = 1$,

$$(b) \quad \frac{d^4 y}{dx^4} + \frac{d^2 y}{dx^2} = 0, \quad y(0) = y''(0) = y'''(0) = 0, \quad y'(0) = 1,$$

$$(c) \quad \frac{d^4 y}{dx^4} = 0, \quad y(0) = y'(0) = y''(0) = 0, \quad y'''(0) = 2.$$

14.28 Solve $y'' - 2y' + y = xe^x$ subject to the initial conditions $y(0) = 0$, $y'(0) = 1$.

14.29 Find the general solution of each equation,

$$(a) \quad y'' = xe^x,$$

$$(b) \quad y'' - 4y' + 4y = x^2,$$

$$(c) \quad y'' + y = \sin x \sin 2x,$$

$$(d) \quad y'' - y = (1 + e^{-x})^2,$$

$$(e) \quad y'' - y = e^x \sin 2x,$$

$$(f) \quad y^{(6)} - y^{(4)} = x^2,$$

$$(g) \quad y'' - 4y' + 4 = e^x + xe^{2x},$$

$$(h) \quad y'' + y = e^{2x}.$$

14.30 Consider the **Euler equation**,

the Euler equation

$$x^n y^{(n)} + a_{n-1} x^{n-1} y^{(n-1)} + \cdots + a_1 x y' + a_0 y = r(x).$$

Substitute $x = e^t$ and show that such a substitution reduces this to a DE with constant coefficients. In particular, solve $x^2 y'' - 4x y' + 6y = x$.

14.31 Show that

- the substitution (14.49) reduces the Schrödinger equation to (14.50), and
- derive the continuity equation for probability from the second equation of (14.50).

14.32 Show that the usual definition of probability current density,

$$\mathbf{J} = \text{Re} \left[\psi^* \frac{\hbar}{im} \nabla \psi \right],$$

reduces to that in Eq. (14.51) if we use (14.49).

We have familiarized ourselves with some useful techniques for finding solutions to differential equations. One powerful method that leads to formal solutions is power series. We also stated Theorem 14.6.4 which guarantees the convergence of the solution of the power series within a circle whose size is at least as large as the smallest of the circles of convergence of the coefficient functions. Thus, the convergence of the solution is related to the convergence of the coefficient functions. What about the nature of the convergence, or the analyticity of the solution? Is it related to the analyticity of the coefficient functions? If so, how? Are the singular points of the coefficients also singular points of the solution? Is the nature of the singularities the same? This chapter answers some of these questions.

Analyticity is best handled in the complex plane. An important reason for this is the property of analytic continuation discussed in Chap. 12. The differential equation $du/dx = u^2$ has a solution $u = -1/x$ for all x except $x = 0$. Thus, we have to “puncture” the real line by removing $x = 0$ from it. Then we have two solutions, because the domain of definition of $u = -1/x$ is not connected on the real line (technically, the definition of a function includes its domain as well as the rule for going from the domain to the range). In addition, if we confine ourselves to the real line, there is no way that we can connect the $x > 0$ region to the $x < 0$ region. However, in the complex plane the same equation, $dw/dz = w^2$, has the complex solution $w = -1/z$, which is analytic everywhere except at $z = 0$. Puncturing the complex plane does not destroy the connectivity of the region of definition of w . Thus, the solution in the $x > 0$ region can be analytically continued to the solution in the $x < 0$ region by going around the origin.

The aim of this chapter is to investigate the analytic properties of the solutions of some well known SOLDEs in mathematical physics. We begin with a result from differential equation theory (for a proof, see [Birk 78, p. 223]).

Proposition 15.0.1 (Continuation principle) *The function obtained by analytic continuation of any solution of an analytic differential equation along any path in the complex plane is a solution of the analytic continuation of the differential equation along the same path.*

continuation principle

An analytic differential equation is one with analytic coefficient functions. This proposition makes it possible to find a solution in one region of the complex plane and then continue it analytically. The following example shows how the singularities of the coefficient functions affect the behavior of the solution.

Example 15.0.2 Let us consider the FODE $w' - (\gamma/z)w = 0$ for $\gamma \in \mathbb{R}$. The coefficient function $p(z) = -\gamma/z$ has a simple pole at $z = 0$. The solution to the FODE is easily found to be $w = z^\gamma$. Thus, depending on whether γ is a nonnegative integer, a negative integer $-m$, or a noninteger, the solution has a regular point, a pole of order m , or a branch point at $z = 0$, respectively.

This example shows that the singularities of the solution depend on the parameters of the differential equation.

15.1 Analytic Properties of Complex DEs

To prepare for discussing the analytic properties of the solutions of SOLDEs, let us consider some general properties of differential equations from a complex analytical point of view.

15.1.1 Complex FOLDEs

In the homogeneous FOLDE

$$\frac{dw}{dz} + p(z)w = 0, \quad (15.1)$$

$p(z)$ is assumed to have only isolated singular points. It follows that $p(z)$ can be expanded about a point z_0 —which may be a singularity of $p(z)$ —as a Laurent series in some annular region $r_1 < |z - z_0| < r_2$:

$$p(z) = \sum_{n=-\infty}^{\infty} a_n (z - z_0)^n \quad \text{where} \quad r_1 < |z - z_0| < r_2.$$

The solution to Eq. (15.1), as given in Theorem 14.2.1 with $q = 0$, is

$$\begin{aligned} w(z) &= \exp\left[-\int p(z) dz\right] \\ &= C \exp\left[-a_{-1} \int \frac{dz}{z - z_0} - \sum_{n=0}^{\infty} a_n \int (z - z_0)^n dz \right. \\ &\quad \left. - \sum_{n=2}^{\infty} a_{-n} \int (z - z_0)^{-n} dz\right] \end{aligned}$$

$$= C \exp \left[-a_{-1} \ln(z - z_0) - \sum_{n=0}^{\infty} \frac{a_n}{n+1} (z - z_0)^{n+1} + \sum_{n=1}^{\infty} \frac{a_{-n-1}}{n} (z - z_0)^{-n} \right]$$

We can write this solution as

$$w(z) = C(z - z_0)^\alpha g(z), \quad (15.2)$$

where $\alpha \equiv -a_{-1}$ and $g(z)$ is an analytic *single-valued* function in the annular region $r_1 < |z - z_0| < r_2$ because $g(z)$ is the exponential of an analytic function.

For the special case in which p has a simple pole, i.e., when $a_{-n} = 0$ for all $n \geq 2$, the second sum in the exponent will be absent, and g will be analytic even at z_0 . In fact, $g(z_0) = 1$, and choosing $C = 1$, we can write

$$w(z) = (z - z_0)^\alpha \left[1 + \sum_{k=1}^{\infty} b_k (z - z_0)^k \right]. \quad (15.3)$$

Depending on the nature of the singularity of $p(z)$ at z_0 , the solutions given by Eq. (15.2) have different classifications. For instance, if $p(z)$ has a removable singularity (if $a_{-n} = 0 \forall n \geq 1$), the solution is $Cg(z)$, which is analytic. In this case, we say that the FOLDE [Eq. (15.1)] has a *removable singularity at z_0* . If $p(z)$ has a simple pole at z_0 (if $a_{-1} \neq 0$ and $a_{-n} = 0 \forall n \geq 2$), then in general, the solution has a branch point at z_0 . In this case we say that the FOLDE has a *regular singular point*. Finally, if $p(z)$ has a pole of order $m > 1$, then the solution will have an essential singularity (see Problem 15.1). In this case the FOLDE is said to have an *irregular singular point*.

The singularity of the coefficient functions of an FOLDE determines the singularity of the solution.

To arrive at the solution given by Eq. (15.2), we had to solve the FOLDE. Since higher-order differential equations are not as easily solved, it is desirable to obtain such a solution through other considerations. The following example sets the stage for this endeavor.

Example 15.1.1 A FOLDE has a unique solution, to within a multiplicative constant, given by Theorem 14.2.1. Thus, given a solution $w(z)$, any other solution must be of the form $Cw(z)$. Let z_0 be a singularity of $p(z)$, and let $z - z_0 = re^{i\theta}$. Start at a point z and circle z_0 so that $\theta \rightarrow \theta + 2\pi$. Even though $p(z)$ may have a simple pole at z_0 , the solution may have a branch point there. This is clear from the general solution, where α may be a noninteger. Thus, $\tilde{w}(z) \equiv w(z_0 + re^{i(\theta+2\pi)})$ may be different from $w(z)$. To discover this branch point—without solving the DE—invoke Proposition 15.0.1 and conclude that $\tilde{w}(z)$ is also a solution to the FOLDE. Thus, $\tilde{w}(z)$ can be different from $w(z)$ by at most a multiplicative constant: $\tilde{w}(z) = Cw(z)$. Define the *complex* number α by $C = e^{2\pi i\alpha}$. Then the function $g(z) \equiv (z - z_0)^{-\alpha} w(z)$ is single-valued

around z_0 . In fact,

$$\begin{aligned} g(z_0 + re^{i(\theta+2\pi)}) &= [re^{i(\theta+2\pi)}]^{-\alpha} w(z_0 + re^{i(\theta+2\pi)}) \\ &= (z - z_0)^{-\alpha} e^{-2\pi i\alpha} e^{2\pi i\alpha} w(z) = (z - z_0)^{-\alpha} w(z) = g(z). \end{aligned}$$

This argument shows that a solution $w(z)$ of the FOLDE of Eq. (15.1) can be written as $w(z) = (z - z_0)^\alpha g(z)$, where $g(z)$ is single-valued.

15.1.2 The Circuit Matrix

The method used in Example 15.1.1 can be generalized to obtain a similar result for the NOLDE

$$\mathbf{L}[w] = \frac{d^n w}{dz^n} + p_{n-1}(z) \frac{d^{n-1} w}{dz^{n-1}} + \cdots + p_1(z) \frac{dw}{dz} + p_0(z)w = 0 \quad (15.4)$$

where all the $p_i(z)$ are analytic in $r_1 < |z - z_0| < r_2$.

Let $\{w_j(z)\}_{j=1}^n$ be a basis of solutions of Eq. (15.4), and let $z - z_0 = re^{i\theta}$. Start at z and analytically continue the functions $w_j(z)$ one complete turn to $\theta + 2\pi$. Let $\tilde{w}_j(z) \equiv \tilde{w}_j(z_0 + re^{i\theta}) \equiv w_j(z_0 + re^{i(\theta+2\pi)})$. Then, by a generalization of Proposition 15.0.1, $\{\tilde{w}_j(z)\}_{j=1}^n$ are not only solutions, but they are linearly independent (because they are w_j 's evaluated at a different point). Therefore, they also form a basis of solutions. On the other hand, $\tilde{w}_j(z)$ can be expressed as a linear combination of the $w_j(z)$. Thus,

$$\tilde{w}_j(z) = w_j(z_0 + re^{i(\theta+2\pi)}) = \sum_{k=1}^n a_{jk} w_k(z).$$

circuit matrix The matrix $\mathbf{A} = (a_{jk})$, called the **circuit matrix** of the NOLDE, is invertible, because it transforms one basis into another. Therefore, it has only nonzero eigenvalues. We let λ be one such eigenvalue, and choose the column vector \mathbf{C} , with entries $\{c_i\}_{i=1}^n$, to be the corresponding eigenvector of the transpose of \mathbf{A} (note that \mathbf{A} and \mathbf{A}^t have the same set of eigenvalues). At least one such eigenvector always exists, because the characteristic polynomial of \mathbf{A}^t has at least one root. Now we let $w(z) = \sum_{j=1}^n c_j w_j(z)$. Clearly, this $w(z)$ is a solution of (15.4), and

$$\begin{aligned} \tilde{w}(z) &\equiv w(z_0 + re^{i(\theta+2\pi)}) = \sum_{j=1}^n c_j w_j(z_0 + re^{i(\theta+2\pi)}) \\ &= \sum_{j=1}^n c_j \sum_{k=1}^n a_{jk} w_k(z) = \sum_{j,k} (\mathbf{A}^t)_{kj} c_j w_k(z) = \sum_{k=1}^n \lambda c_k w_k(z) = \lambda w(z). \end{aligned}$$

If we define α by $\lambda = e^{2\pi i\alpha}$, then $w(z_0 + re^{i(\theta+2\pi)}) = e^{2\pi i\alpha} w(z)$. Now we write $f(z) \equiv (z - z_0)^{-\alpha} w(z)$. Following the argument used in Example 15.1.1, we get $f(z_0 + re^{i(\theta+2\pi)}) = f(z)$; that is, $f(z)$ is single-valued around z_0 . We thus have the following theorem.

Theorem 15.1.2 Any homogeneous NOLDE with analytic coefficient functions in $r_1 < |z - z_0| < r_2$ admits a solution of the form

$$w(z) = (z - z_0)^\alpha f(z)$$

where $f(z)$ is single-valued around z_0 in $r_1 < |z - z_0| < r_2$.

An isolated singular point z_0 near which an analytic function $w(z)$ can be written as $w(z) = (z - z_0)^\alpha f(z)$, where $f(z)$ is single-valued and analytic in the punctured neighborhood of z_0 , is called a **simple branch point** of $w(z)$. The arguments leading to Theorem 15.1.2 imply that a solution with a simple branch point exists if and only if the vector \mathbf{C} whose components appear in $w(z)$ is an eigenvector of A^t , the transpose of the circuit matrix. Thus, there are as many solutions with simple branch points as there are linearly independent eigenvectors of A^t .

15.2 Complex SOLDEs

Let us now consider the SOLDE $w'' + p(z)w' + q(z)w = 0$. Given two linearly independent solutions $w_1(z)$ and $w_2(z)$, we form the 2×2 matrix A and try to diagonalize it. There are three possible outcomes:

1. The matrix A is diagonalizable, and we can find two eigenvectors, $F(z)$ and $G(z)$, corresponding, respectively, to two distinct eigenvalues, λ_1 and λ_2 . This means that

$$F(z_0 + re^{i(\theta+2\pi)}) = \lambda_1 F(z), \quad \text{and} \quad G(z_0 + re^{i(\theta+2\pi)}) = \lambda_2 G(z).$$

Defining $\lambda_1 = e^{2\pi i\alpha}$ and $\lambda_2 = e^{2\pi i\beta}$, we get

$$F(z) = (z - z_0)^\alpha f(z) \quad \text{and} \quad G(z) = (z - z_0)^\beta g(z),$$

as Theorem 15.1.2 suggests. The set $\{F(z), G(z)\}$ is called a **canonical basis** of the SOLDE.

2. The matrix A is diagonalizable, and the two eigenvalues are the same. In this case both $F(z)$ and $G(z)$ have the same constant α :

$$F(z) = (z - z_0)^\alpha f(z) \quad \text{and} \quad G(z) = (z - z_0)^\alpha g(z).$$

3. We cannot find two eigenvectors. This corresponds to the case where A is not diagonalizable. However, we can always find one eigenvector, so A has only one eigenvalue, λ . We let $w_1(z)$ be the solution of the form $(z - z_0)^\alpha f(z)$, where $f(z)$ is single-valued and $\lambda = e^{2\pi i\alpha}$. The existence of such a solution is guaranteed by Theorem 15.1.2. Let $w_2(z)$ be any other linearly independent solution (Theorem 14.3.5 ensures the existence of such a second solution). Then

$$w_2(z_0 + re^{i(\theta+2\pi)}) = aw_1(z) + bw_2(z),$$

and the circuit matrix will be $A = \begin{pmatrix} \lambda & 0 \\ a & b \end{pmatrix}$, which has eigenvalues λ and b . Since A is assumed to have only one eigenvalue (otherwise we would have the first outcome again), we must have $b = \lambda$. This reduces A to $A = \begin{pmatrix} \lambda & 0 \\ a & \lambda \end{pmatrix}$, where $a \neq 0$. The condition $a \neq 0$ is necessary to distinguish this case from the second outcome. Now we analytically continue $h(z) \equiv w_2(z)/w_1(z)$ one whole turn around z_0 , obtaining

$$\begin{aligned} h(z_0 + re^{i(\theta+2\pi)}) &= \frac{w_2(z_0 + re^{i(\theta+2\pi)})}{w_1(z_0 + re^{i(\theta+2\pi)})} = \frac{aw_1(z) + \lambda w_2(z)}{\lambda w_1(z)} \\ &= \frac{a}{\lambda} + \frac{w_2(z)}{w_1(z)} = \frac{a}{\lambda} + h(z). \end{aligned}$$

It then follows that the function¹

$$g_1(z) \equiv h(z) - \frac{a}{2\pi i \lambda} \ln(z - z_0)$$

is single-valued in $r_1 < |z - z_0| < r_2$. If we redefine $g_1(z)$ and $w_2(z)$ as $(2\pi i \lambda/a)g_1(z)$ and $(2\pi i \lambda/a)w_2(z)$, respectively, we have the following:

Theorem 15.2.1 *If $p(z)$ and $q(z)$ are analytic for $r_1 < |z - z_0| < r_2$, then the SOLDE $w'' + p(z)w' + q(z)w = 0$ admits a basis of solutions $\{w_1, w_2\}$ in the neighborhood of the singular point z_0 , where either*

$$w_1(z) = (z - z_0)^\alpha f(z), \quad w_2(z) = (z - z_0)^\beta g(z)$$

or, in exceptional cases (when the circuit matrix is not diagonalizable),

$$w_1(z) = (z - z_0)^\alpha f(z), \quad w_2(z) = w_1(z)[g_1(z) + \ln(z - z_0)].$$

The functions $f(z)$, $g(z)$, and $g_1(z)$ are analytic and single-valued in the annular region.

This theorem allows us to factor out the *branch point* z_0 from the rest of the solutions. However, even though $f(z)$, $g(z)$, and $g_1(z)$ are analytic in the annular region $r_1 < |z - z_0| < r_2$, they may very well have poles of arbitrary orders at z_0 . Can we also factor out the *poles*? In general, we cannot; however, under special circumstances, described in the following definition, we can.

Definition 15.2.2 A SOLDE $w'' + p(z)w' + q(z)w = 0$ that is analytic in $0 < |z - z_0| < r$ is said to have a **regular singular point** at z_0 if $p(z)$ has at worst a simple pole and $q(z)$ has at worst a pole of order 2 there.

¹Recall that $\ln(z - z_0)$ increases by $2\pi i$ for each turn around z_0 .

In a neighborhood of a regular singular point z_0 , the coefficient functions $p(z)$ and $q(z)$ have the power-series expansions

$$p(z) = \frac{a_{-1}}{z - z_0} + \sum_{k=0}^{\infty} a_k (z - z_0)^k,$$

$$q(z) = \frac{b_{-2}}{(z - z_0)^2} + \frac{b_{-1}}{z - z_0} + \sum_{k=0}^{\infty} b_k (z - z_0)^k.$$

Multiplying both sides of the first equation by $z - z_0$ and the second by $(z - z_0)^2$ and introducing $P(z) \equiv (z - z_0)p(z)$, $Q(z) \equiv (z - z_0)^2 q(z)$, we obtain

$$P(z) = \sum_{k=0}^{\infty} a_{k-1} (z - z_0)^k, \quad Q(z) = \sum_{k=0}^{\infty} b_{k-2} (z - z_0)^k.$$

It is also convenient to multiply the SOLDE by $(z - z_0)^2$ and write it as

$$(z - z_0)^2 w'' + (z - z_0)P(z)w' + Q(z)w = 0. \quad (15.5)$$

Inspired by the discussion leading to Theorem 15.2.1, we write

$$w(z) = (z - z_0)^\nu \sum_{k=0}^{\infty} C_k (z - z_0)^k, \quad C_0 = 1, \quad (15.6)$$

where we have chosen the arbitrary multiplicative constant in such a way that $C_0 = 1$. Substitute this in Eq. (15.5), and change the dummy variable—to obtain

$$\sum_{n=0}^{\infty} \left\{ (n + \nu)(n + \nu - 1)C_n + \sum_{k=0}^n [(k + \nu)a_{n-k-1} + b_{n-k-2}]C_k \right\} \\ \times (z - z_0)^{n+\nu} = 0,$$

which results in the recursion relation

$$(n + \nu)(n + \nu - 1)C_n = - \sum_{k=0}^n [(k + \nu)a_{n-k-1} + b_{n-k-2}]C_k. \quad (15.7)$$

For $n = 0$, this leads to what is known as the **indicial equation** for the exponent ν :

$$I(\nu) \equiv \nu(\nu - 1) + a_{-1}\nu + b_{-2} = 0. \quad (15.8)$$

The roots of this equation are called the **characteristic exponents** of z_0 , and $I(\nu)$ is called its **indicial polynomial**. In terms of this polynomial, (15.7) can be expressed as

$$I(n + \nu)C_n = - \sum_{k=0}^{n-1} [(k + \nu)a_{n-k-1} + b_{n-k-2}]C_k \quad \text{for } n = 1, 2, \dots \quad (15.9)$$

indicial equation, indicial polynomial, characteristic exponents

Equation (15.8) determines what values of ν are possible, and Eq. (15.9) gives C_1, C_2, C_3, \dots , which in turn determine $w(z)$. Special care must be taken if the indicial polynomial vanishes at $n + \nu$ for some positive integer n , that is, if $n + \nu$, in addition to ν , is a root of the indicial polynomial: $I(n + \nu) = 0 = I(\nu)$.

If ν_1 and ν_2 are characteristic exponents of the indicial equation and $\text{Re}(\nu_1) > \text{Re}(\nu_2)$, then a solution for ν_1 always exists. A solution for ν_2 also exists if $\nu_1 - \nu_2 \neq n$ for any (positive) integer n . In particular, if z_0 is an ordinary point [a point at which both $p(z)$ and $q(z)$ are analytic], then only one solution is determined by (15.9). (Why?) The foregoing discussion is summarized in the following:

Theorem 15.2.3 *If the differential equation $w'' + p(z)w' + q(z)w = 0$ has a regular singular point at $z = z_0$, then at least one power series of the form of (15.6) formally solves the equation. If ν_1 and ν_2 are the characteristic exponents of z_0 , then there are two linearly independent formal solutions unless $\nu_1 - \nu_2$ is an integer.*

Example 15.2.4 Let us consider some familiar differential equations.

(a) The Bessel equation is

$$w'' + \frac{1}{z}w' + \left(1 - \frac{\alpha^2}{z^2}\right)w = 0.$$

In this case, the origin is a regular singular point, $a_{-1} = 1$, and $b_{-2} = -\alpha^2$. Thus, the indicial equation is $\nu(\nu - 1) + \nu - \alpha^2 = 0$, and its solutions are $\nu_1 = \alpha$ and $\nu_2 = -\alpha$. Therefore, there are two linearly independent solutions to the Bessel equation unless $\nu_1 - \nu_2 = 2\alpha$ is an integer, i.e., unless α is either an integer or a half-integer.

(b) For the Coulomb potential $f(r) = \beta/r$, the radial equation (13.14) reduces to

$$w'' + \frac{2}{z}w' + \left(\frac{\beta}{z} - \frac{\alpha}{z^2}\right)w = 0.$$

The point $z = 0$ is a regular singular point at which $a_{-1} = 2$ and $b_{-2} = -\alpha$. The indicial polynomial is $I(\nu) = \nu^2 + \nu - \alpha$ with characteristic exponents

$$\nu_1 = -\frac{1}{2} + \frac{1}{2}\sqrt{1 + 4\alpha} \quad \text{and} \quad \nu_2 = -\frac{1}{2} - \frac{1}{2}\sqrt{1 + 4\alpha}.$$

There are two independent solutions unless $\nu_1 - \nu_2 = \sqrt{1 + 4\alpha}$ is an integer. In practice, $\alpha = l(l + 1)$, where l is some integer; so $\nu_1 - \nu_2 = 2l + 1$, and only one solution is obtained.

hypergeometric differential equation (c) The **hypergeometric** differential equation is

$$w'' + \frac{\gamma - (\alpha + \beta + 1)z}{z(1 - z)}w' - \frac{\alpha\beta}{z(1 - z)}w = 0.$$

A substantial number of functions in mathematical physics are solutions of this remarkable equation, with appropriate values for α , β , and γ . The regular singular points² are $z = 0$ and $z = 1$. At $z = 0$, $a_{-1} = \gamma$ and $b_{-2} = 0$. The indicial polynomial is $I(v) = v(v + \gamma - 1)$, whose roots are $v_1 = 0$ and $v_2 = 1 - \gamma$. Unless γ is an integer, we have two formal solutions.

It is shown in differential equation theory [Birk 78, pp. 40–242] that as long as $v_1 - v_2$ is not an integer, the series solution of Theorem 15.2.3 is convergent for a neighborhood of z_0 . What happens when $v_1 - v_2$ is an integer? First, as a convenience, we translate the coordinate axes so that the point z_0 coincides with the origin. This will save us some writing, because instead of powers of $z - z_0$, we will have powers of z . Next we let $v_1 = v_2 + n$ with n a *positive* integer. Then, since it is impossible to encounter any new zero of the indicial polynomial beyond v_1 , the recursion relation, Eq. (15.9), will be valid for all values of n , and we obtain a solution:

$$w_1(z) = z^{v_1} f(z) = z^{v_1} \left(1 + \sum_{k=1}^{\infty} C_k z^k \right),$$

which is convergent in the region $0 < |z| < r$ for some $r > 0$.

To investigate the nature and the possibility of the second solution, write the recursion relations of Eq. (15.9) for the smaller characteristic root v_2 :

$$\begin{aligned} I(v_2 + 1)C_1 &= \overbrace{-(v_2 a_0 + b_{-1})}^{\equiv \rho_1 I(v_2 + 1)} C_0 \Rightarrow C_1 = \rho_1, \\ I(v_2 + 2)C_2 &= -(v_2 a_1 + b_0)C_0 - [(v_2 + 1)a_0 + b_{-1}]C_1 \Rightarrow C_2 \equiv \rho_2, \\ &\vdots \\ I(v_2 + n - 1)C_{n-1} &\equiv \rho_{n-1} I(v_2 + n - 1)C_0 \Rightarrow C_{n-1} = \rho_{n-1}, \\ I(v_2 + n)C_n &= I(v_1)C_n = \rho_n C_0 \Rightarrow 0 = \rho_n, \end{aligned} \tag{15.10}$$

where in each step, we have used the result of the previous step in which C_k is given as a multiple of $C_0 = 1$. Here, the ρ 's are constants depending (possibly in a very complicated way) on the a_k 's and b_k 's.

Theorem 15.2.3 guarantees two power series solutions only when $v_1 - v_2$ is not an integer. When $v_1 - v_2$ is an integer, Eq. (15.10) shows that a necessary condition for a second *power series* solution to exist is that $\rho_n = 0$. Therefore, when $\rho_n \neq 0$, we have to resort to other means of obtaining the second solution.

Let us define the second solution as

$$w_2(z) \equiv w_1(z)h(z) = \overbrace{z^{v_1} f(z)}^{\equiv w_1(z)} h(z) \tag{15.11}$$

²The coefficient of w need not have a pole of order 2. Its pole can be of order one as well.

and substitute in the SOLDE to obtain a FOLDE in h' , namely,

$$h'' + (p + 2w'_1/w_1)h' = 0,$$

or, by substituting $w'_1/w_1 = v_1/z + f'/f$, the equivalent FOLDE

$$h'' + \left(\frac{2v_1}{z} + \frac{2f'}{f} + p \right) h' = 0. \quad (15.12)$$

Lemma 15.2.5 *The coefficient of h' in Eq. (15.12) has a residue of $n + 1$.*

Proof Recall that the residue of a function is the coefficient of z^{-1} in the Laurent expansion of the function (about $z = 0$). Let us denote this residue for the coefficient of h' by A_{-1} . Since $f(0) = 1$, the ratio f'/f is analytic at $z = 0$. Thus, the simple pole at $z = 0$ comes from the other two terms. Substituting the Laurent expansion of $p(z)$ gives

$$\frac{2v_1}{z} + p = \frac{2v_1}{z} + \frac{a_{-1}}{z} + a_0 + a_1z + \cdots$$

This shows that $A_{-1} = 2v_1 + a_{-1}$. On the other hand, comparing the two versions of the indicial polynomial

$$v^2 + (a_{-1} - 1)v + b_{-2} \quad \text{and} \quad (v - v_1)(v - v_2) = v^2 - (v_1 + v_2)v + v_1v_2$$

gives

$$v_1 + v_2 = -(a_{-1} - 1), \quad \text{or} \quad 2v_1 - n = -(a_{-1} - 1).$$

Therefore, $A_{-1} = 2v_1 + a_{-1} = n + 1$. □

Theorem 15.2.6 *Suppose that the characteristic exponents of a SOLDE with a regular singular point at $z = 0$ are v_1 and v_2 . Consider three cases:*

1. $v_1 - v_2$ is not an integer.
2. $v_2 = v_1 - n$ where n is a nonnegative integer, and ρ_n , as defined in Eq. (15.10), vanishes.
3. $v_2 = v_1 - n$ where n is a nonnegative integer, and ρ_n , as defined in Eq. (15.10), does not vanish.

Then, in the first two cases, there exists a basis of solutions $\{w_1, w_2\}$ of the form

$$w_i(z) = z^{v_i} \left(1 + \sum_{k=1}^{\infty} C_k^{(i)} z^k \right), \quad i = 1, 2,$$

and in the third case, the basis of solutions takes the form

$$w_1(z) = z^{v_1} \left(1 + \sum_{k=1}^{\infty} a_k z^k \right), \quad w_2(z) = z^{v_2} \left(1 + \sum_{k=1}^{\infty} b_k z^k \right) + C w_1(z) \ln z,$$

where the power series are convergent in a neighborhood of $z = 0$.

Proof The first two cases have been shown before. For the third case, we use Lemma 15.2.5 and write

$$\frac{2\nu_1}{z} + \frac{2f'}{f} + p = \frac{n+1}{z} + \sum_{k=0}^{\infty} c_k z^k,$$

and the solution for the FOLDE in h' will be [see Eq. (15.3) and the discussion preceding it]

$$h'(z) = z^{-n-1} \left(1 + \sum_{k=1}^{\infty} b_k z^k \right).$$

For $n = 0$, i.e., when the indicial polynomial has a double root, this yields

$$h'(z) = 1/z + \sum_{k=1}^{\infty} b_k z^{k-1} \Rightarrow h(z) = \ln z + g_1(z),$$

where g_1 is analytic in a neighborhood of $z = 0$. For $n \neq 0$, we have $h'(z) = b_n/z + \sum_{k \neq n}^{\infty} b_k z^{k-n-1}$ and, by integration,

$$\begin{aligned} h(z) &= b_n \ln z + \sum_{k \neq n}^{\infty} \frac{b_k}{k-n} z^{k-n} \\ &= b_n \ln z + z^{-n} \sum_{k \neq n}^{\infty} \frac{b_k}{k-n} z^k = b_n \ln z + z^{-n} g_2(z), \end{aligned}$$

where g_2 is analytic in a neighborhood of $z = 0$. Substituting h in Eq. (15.11) and recalling that $\nu_2 = \nu_1 - n$, we obtain the desired results of the theorem. \square

15.3 Fuchsian Differential Equations

In many cases of physical interest, the behavior of the solution of a SOLDE at infinity is important. For instance, bound state solutions of the Schrödinger equation describing the probability amplitudes of particles in quantum mechanics must tend to zero as the distance from the center of the binding force increases.

We have seen that the behavior of a solution is determined by the behavior of the coefficient functions. To determine the behavior at infinity, we substitute $z = 1/t$ in the SOLDE

$$\frac{d^2 w}{dz^2} + p(z) \frac{dw}{dz} + q(z)w = 0 \quad (15.13)$$

and obtain

$$\frac{d^2 v}{dt^2} + \left[\frac{2}{t} - \frac{1}{t^2} r(t) \right] \frac{dv}{dt} + \frac{1}{t^4} s(t)v = 0, \quad (15.14)$$

where $v(t) = w(1/t)$, $r(t) = p(1/t)$, and $s(t) = q(1/t)$.

Clearly, as $z \rightarrow \infty$, $t \rightarrow 0$. Thus, we are interested in the behavior of (15.14) at $t = 0$. We assume that both $r(t)$ and $s(t)$ are analytic at $t = 0$. Equation (15.14) shows, however, that the solution $v(t)$ may still have singularities at $t = 0$ because of the extra terms appearing in the coefficient functions.

We assume that infinity is a regular singular point of (15.13), by which we mean that $t = 0$ is a regular singular point of (15.14). Therefore, in the Taylor expansions of $r(t)$ and $s(t)$, the first (constant) term of $r(t)$ and the first two terms of $s(t)$ must be zero. Thus, we write

$$r(t) = a_1 t + a_2 t^2 + \cdots = \sum_{k=1}^{\infty} a_k t^k,$$

$$s(t) = b_2 t^2 + b_3 t^3 + \cdots = \sum_{k=2}^{\infty} b_k t^k.$$

By their definitions, these two equations imply that for $p(z)$ and $q(z)$, and for large values of $|z|$, we must have expressions of the form

$$p(z) = \frac{a_1}{z} + \frac{a_2}{z^2} + \cdots = \sum_{k=1}^{\infty} \frac{a_k}{z^k},$$

$$q(z) = \frac{b_2}{z^2} + \frac{b_3}{z^3} + \cdots = \sum_{k=2}^{\infty} \frac{b_k}{z^k}.$$
(15.15)

When infinity is a regular singular point of Eq. (15.13), or, equivalently, when the origin is a regular singular point of (15.14), it follows from Theorem 15.2.6 that there exists at least one solution of the form $v_1(t) = t^\alpha (1 + \sum_{k=1}^{\infty} C_k t^k)$ or, in terms of z ,

$$w_1(z) = z^{-\alpha} \left(1 + \sum_{k=1}^{\infty} \frac{C_k}{z^k} \right).$$
(15.16)

Here α is a characteristic exponents at $t = 0$ of (15.14), whose indicial polynomial is easily found to be $\alpha(\alpha - 1) + (2 - a_1)\alpha + b_2 = 0$.

Definition 15.3.1 A homogeneous differential equation with single-valued analytic coefficient functions is called a **Fuchsian** differential equation (FDE) if it has *only* regular singular points in the extended complex plane, i.e., the complex plane including the point at infinity.

It turns out that a particular kind of FDE describes a large class of nonelementary functions encountered in mathematical physics. Therefore, it is instructive to classify various kinds of FDEs. A fact that is used in such a classification is that complex functions whose only singularities in the *extended* complex plane are poles are rational functions, i.e., ratios of polynomials (see Proposition 11.2.2). We thus expect FDEs to have only rational functions as coefficients.

Consider the case where the equation has at most two regular singular points at z_1 and z_2 . We introduce a new variable $\xi(z) = \frac{z-z_1}{z-z_2}$. The regular singular points at z_1 and z_2 are mapped onto the points $\xi_1 = \xi(z_1) = 0$ and $\xi_2 = \xi(z_2) = \infty$, respectively, in the extended ξ -plane. Equation (15.13) becomes

$$\frac{d^2u}{d\xi^2} + \Phi(\xi)\frac{du}{d\xi} + \Theta(\xi)u = 0, \tag{15.17}$$

where u , Φ , and Θ are functions of ξ obtained when z is expressed in terms of ξ in $w(z)$, $p(z)$, and $q(z)$, respectively. From Eq. (15.15) and the fact that $\xi = 0$ is at most a simple pole of $\Phi(\xi)$, we obtain $\Phi(\xi) = a_1/\xi$. Similarly, $\Theta(\xi) = b_2/\xi^2$. Thus, a SOFDE with two regular singular points is equivalent to the DE $w'' + (a_1/z)w' + (b_2/z^2)w = 0$. Multiplying both sides by z^2 , we obtain $z^2w'' + a_1zw' + b_2w = 0$, which is the second-order Euler differential equation. A general n th-order Euler differential equation is equivalent to a NOLDE with constant coefficients (see Problem 14.30). Thus, a second order Fuchsian DE (SOFDE) with two regular singular points is equivalent to a SOLDE with constant coefficients and produces nothing new.

The simplest SOFDE whose solutions may include nonelementary functions is therefore one having three regular singular points, at say z_1 , z_2 , and z_3 . By the transformation

$$\xi(z) = \frac{(z - z_1)(z_3 - z_2)}{(z - z_2)(z_3 - z_1)}$$

we can map z_1 , z_2 , and z_3 onto $\xi_1 = 0$, $\xi_2 = \infty$, and $\xi_3 = 1$. Thus, we assume that the three regular singular points are at $z = 0$, $z = 1$, and $z = \infty$. It can be shown [see Problem (15.8)] that the most general $p(z)$ and $q(z)$ are

$$p(z) = \frac{A_1}{z} + \frac{B_1}{z-1} \quad \text{and} \quad q(z) = \frac{A_2}{z^2} + \frac{B_2}{(z-1)^2} - \frac{A_3}{z(z-1)}.$$

We thus have the following:

Theorem 15.3.2 *The most general second order Fuchsian DE with three regular singular points can be transformed into the form*

$$w'' + \left(\frac{A_1}{z} + \frac{B_1}{z-1} \right) w' + \left[\frac{A_2}{z^2} + \frac{B_2}{(z-1)^2} - \frac{A_3}{z(z-1)} \right] w = 0, \tag{15.18}$$

where A_1, A_2, A_3, B_1 , and B_2 are constants. This equation is called the **Riemann differential equation**.

We can write the Riemann DE in terms of pairs of characteristic exponents, (λ_1, λ_2) , (μ_1, μ_2) , and (ν_1, ν_2) , belonging to the singular points 0, 1, and ∞ , respectively. The indicial equations are easily found to be

$$\begin{aligned} \lambda^2 + (A_1 - 1)\lambda + A_2 &= 0, \\ \mu^2 + (B_1 - 1)\mu + B_2 &= 0, \\ \nu^2 + (1 - A_1 - B_1)\nu + A_2 + B_2 - A_3 &= 0. \end{aligned}$$

A second-order Fuchsian DE with two regular singular points leads to uninteresting solutions!

A second-order Fuchsian DE with three regular singular points leads to interesting solutions!

Riemann differential equation

By writing the indicial equations as $(\lambda - \lambda_1)(\lambda - \lambda_2) = 0$, and so forth and comparing coefficients, we can find the following relations:

$$\begin{aligned} A_1 &= 1 - \lambda_1 - \lambda_2, & A_2 &= \lambda_1 \lambda_2, \\ B_1 &= 1 - \mu_1 - \mu_2, & B_2 &= \mu_1 \mu_2, \\ A_1 + B_1 &= \nu_1 + \nu_2 + 1, & A_2 + B_2 - A_3 &= \nu_1 \nu_2. \end{aligned}$$

Riemann identity These equations lead easily to the **Riemann identity**

$$\lambda_1 + \lambda_2 + \mu_1 + \mu_2 + \nu_1 + \nu_2 = 1. \quad (15.19)$$

Substituting these results in (15.18) gives the following result.

Theorem 15.3.3 *A second order Fuchsian DE with three regular singular points in the extended complex plane is equivalent to the Riemann DE,*

$$\begin{aligned} w'' + \left(\frac{1 - \lambda_1 - \lambda_2}{z} + \frac{1 - \mu_1 - \mu_2}{z - 1} \right) w' \\ + \left[\frac{\lambda_1 \lambda_2}{z^2} + \frac{\mu_1 \mu_2}{(z - 1)^2} + \frac{\nu_1 \nu_2 - \lambda_1 \lambda_2 - \mu_1 \mu_2}{z(z - 1)} \right] w = 0, \end{aligned} \quad (15.20)$$

which is uniquely determined by the pairs of characteristic exponents at each singular point. The characteristic exponents satisfy the Riemann identity, Eq. (15.19).

The uniqueness of the Riemann DE allows us to derive identities for solutions and reduce the independent parameters of Eq. (15.20) from five to three. We first note that if $w(z)$ is a solution of the Riemann DE corresponding to (λ_1, λ_2) , (μ_1, μ_2) , and (ν_1, ν_2) , then the function

$$v(z) = z^\lambda (z - 1)^\mu w(z)$$

has branch points at $z = 0, 1, \infty$ [because $w(z)$ does]; therefore, it is a solution of the Riemann DE. Its pairs of characteristic exponents are (see Problem 15.10)

$$(\lambda_1 + \lambda, \lambda_2 + \lambda), \quad (\mu_1 + \mu, \mu_2 + \mu), \quad (\nu_1 - \lambda - \mu, \nu_2 - \lambda - \mu).$$

In particular, if we let $\lambda = -\lambda_1$ and $\mu = -\mu_1$, then the pairs reduce to

$$(0, \lambda_2 - \lambda_1), \quad (0, \mu_2 - \mu_1), \quad (\nu_1 + \lambda_1 + \mu_1, \nu_2 + \lambda_1 + \mu_1).$$

Defining $\alpha \equiv \nu_1 + \lambda_1 + \mu_1$, $\beta \equiv \nu_2 + \lambda_1 + \mu_1$, and $\gamma \equiv 1 - \lambda_2 + \lambda_1$, and using (15.19), we can write the pairs as

$$(0, 1 - \gamma), \quad (0, \gamma - \alpha - \beta), \quad (\alpha, \beta),$$

which yield the third version of the Riemann DE

$$w'' + \left(\frac{\gamma}{z} + \frac{1 - \gamma + \alpha + \beta}{z - 1} \right) w' + \frac{\alpha \beta}{z(z - 1)} w = 0.$$

This important equation is commonly written in the equivalent form

$$z(1-z)w'' + [\gamma - (1 + \alpha + \beta)z]w' - \alpha\beta w = 0 \quad (15.21)$$

and is called the **hypergeometric** differential equation (HGDE). We will study this equation next.

15.4 The Hypergeometric Function

The two characteristic exponents of Eq. (15.21) at $z = 0$ are 0 and $1 - \gamma$. It follows from Theorem 15.2.6 that there exists an *analytic* solution (corresponding to the characteristic exponent 0) at $z = 0$. Let us denote this solution, the **hypergeometric function**, by $F(\alpha, \beta; \gamma; z)$ and write

$$F(\alpha, \beta; \gamma; z) = \sum_{k=0}^{\infty} a_k z^k \quad \text{where } a_0 = 1.$$

Substituting in the DE, we obtain the recurrence relation

$$a_{k+1} = \frac{(\alpha + k)(\beta + k)}{(k + 1)(\gamma + k)} a_k \quad \text{for } k \geq 0.$$

These coefficients can be determined successively if γ is neither zero nor a negative integer:

$$F(\alpha, \beta; \gamma; z) = \frac{\Gamma(\gamma)}{\Gamma(\alpha)\Gamma(\beta)} \sum_{k=0}^{\infty} \frac{\Gamma(\alpha + k)\Gamma(\beta + k)}{\Gamma(k + 1)\Gamma(\gamma + k)} z^k. \quad (15.22)$$

The series in (15.22) is called the **hypergeometric series**, because it is the generalization of $F(1, \beta; \beta; z)$, which is simply the geometric series.

We note immediately from (15.22) that

Box 15.4.1 *The hypergeometric series becomes a polynomial if either α or β is a negative integer.*

This is because for $k < |\alpha|$ (or $k < |\beta|$) both $\Gamma(\alpha + k)$ [or $\Gamma(\beta + k)$] and $\Gamma(\alpha)$ [or $\Gamma(\beta)$] have poles that cancel each other. However, $\Gamma(\alpha + k)$ [or $\Gamma(\beta + k)$] becomes finite for $k > |\alpha|$ (or $k > |\beta|$), and the pole in $\Gamma(\alpha)$ [or $\Gamma(\beta)$] makes the denominator infinite. Therefore, all terms of the series (15.22) beyond $k = |\alpha|$ (or $k = |\beta|$) will be zero.

Many of the properties of the hypergeometric function can be obtained directly from the HGDE (15.21). For instance, differentiating the HGDE and letting $v = w'$, we obtain

$$z(1-z)v'' + [\gamma + 1 - (\alpha + \beta + 3)z]v' - (\alpha + 1)(\beta + 1)v = 0,$$

which shows that $F'(\alpha, \beta; \gamma; z) = CF(\alpha + 1, \beta + 1; \gamma + 1; z)$. The constant C can be determined by differentiating Eq. (15.22), setting $z = 0$ in the result, and noting that $F(\alpha + 1, \beta + 1; \gamma + 1; 0) = 1$. Then we obtain

$$F'(\alpha, \beta; \gamma; z) = \frac{\alpha\beta}{\gamma} F(\alpha + 1, \beta + 1; \gamma + 1; z). \quad (15.23)$$

Now assume that $\gamma \neq 1$, and make the substitution $w = z^{1-\gamma}u$ in the HGDE to obtain³

$$z(1-z)u'' + [\gamma_1 - (\alpha_1 + \beta_1 + 1)z]u' - \alpha_1\beta_1u = 0,$$

where $\alpha_1 = \alpha - \gamma + 1$, $\beta_1 = \beta - \gamma + 1$, and $\gamma_1 = 2 - \gamma$. Thus,

$$u = F(\alpha - \gamma + 1, \beta - \gamma + 1; 2 - \gamma; z),$$

and u is therefore analytic at $z = 0$. This leads to an interesting result. Provided that γ is not an integer, the two functions

$$w_1(z) \equiv F(\alpha, \beta; \gamma; z), \quad w_2(z) \equiv z^{1-\gamma} F(\alpha - \gamma + 1, \beta - \gamma + 1; 2 - \gamma; z) \quad (15.24)$$

form a canonical basis of solutions to the HGDE at $z = 0$. This follows from Theorem 15.2.6 and the fact that $(0, 1 - \gamma)$ are a pair of (different) characteristic exponents at $z = 0$.



Johann Carl Friedrich
Gauss 1777–1855

Historical Notes

Johann Carl Friedrich Gauss (1777–1855) was the greatest of all mathematicians and perhaps the most richly gifted genius of whom there is any record. He was born in the city of Brunswick in northern Germany. His exceptional skill with numbers was clear at a very early age, and in later life he joked that he knew how to count before he could talk. It is said that Goethe wrote and directed little plays for a puppet theater when he was 6 and that Mozart composed his first childish minuets when he was 5, but Gauss corrected an error in his father's payroll accounts at the age of 3. At the age of seven, when he started elementary school, his teacher was amazed when Gauss summed the integers from 1 to 100 instantly by spotting that the sum was 50 pairs of numbers each pair summing to 101. His long professional life is so filled with accomplishments that it is impossible to give a full account of them in the short space available here. All we can do is simply give a chronology of his almost uncountable discoveries.

- 1792–1794:** Gauss reads the works of Newton, Euler, and Lagrange; discovers the prime number theorem (at the age of 14 or 15); invents the method of least squares; conceives the Gaussian law of distribution in the theory of probability.
- 1795:** (only 18 years old!) Proves that a regular polygon with n sides is constructible (by ruler and compass) if and only if n is the product of a power of 2 and distinct prime numbers of the form $p_k = 2^{2^k} + 1$, and completely solves the 2000-year old problem of ruler-and-compass construction of regular polygons. He also discovers the law of quadratic reciprocity.
- 1799:** Proves the **fundamental theorem of algebra** in his doctoral dissertation using the then-mysterious complex numbers with complete confidence.
- 1801:** Gauss publishes his *Disquisitiones Arithmeticae* in which he creates the modern rigorous approach to mathematics; predicts the exact location of the asteroid Ceres.

³In the following discussion, α_1 , β_1 , and γ_1 will represent the parameters of the new DE satisfied by the new function defined in terms of the old.

- 1807:** Becomes professor of astronomy and the director of the new observatory at Göttingen.
- 1809:** Publishes his second book, *Theoria motus corporum coelestium*, a major two-volume treatise on the motion of celestial bodies and the bible of planetary astronomers for the next 100 years.
- 1812:** Publishes *Disquisitiones generales circa seriem infinitam*, a rigorous treatment of infinite series, and introduces the **hypergeometric function** for the first time, for which he uses the notation $F(\alpha, \beta; \gamma; z)$; an essay on approximate integration.
- 1820–1830:** Publishes over 70 papers, including *Disquisitiones generales circa superficies curvas*, in which he creates the intrinsic **differential geometry** of general curved surfaces, the forerunner of Riemannian geometry and the general theory of relativity. From the 1830s on, Gauss was increasingly occupied with physics, and he enriched every branch of the subject he touched. In the theory of **surface tension**, he developed the fundamental idea of conservation of energy and solved the earliest problem in the **calculus of variations**. In **optics**, he introduced the concept of the focal length of a system of lenses. He virtually created the science of **geomagnetism**, and in collaboration with his friend and colleague Wilhelm Weber he invented the electromagnetic telegraph. In 1839 Gauss published his fundamental paper on the general theory of inverse square forces, which established **potential theory** as a coherent branch of mathematics and in which he established the **divergence theorem**.

Gauss had many opportunities to leave Göttingen, but he refused all offers and remained there for the rest of his life, living quietly and simply, traveling rarely, and working with immense energy on a wide variety of problems in mathematics and its applications. Apart from science and his family—he married twice and had six children, two of whom emigrated to America—his main interests were history and world literature, international politics, and public finance. He owned a large library of about 6000 volumes in many languages, including Greek, Latin, English, French, Russian, Danish, and of course German. His acuteness in handling his own financial affairs is shown by the fact that although he started with virtually nothing, he left an estate over a hundred times as great as his average annual income during the last half of his life.

The foregoing list is the published portion of Gauss's total achievement; the unpublished and private part is almost equally impressive. His scientific diary, a little booklet of 19 pages, discovered in 1898, extends from 1796 to 1814 and consists of 146 very concise statements of the results of his investigations, which often occupied him for weeks or months. These ideas were so abundant and so frequent that he physically did not have time to publish them. Some of the ideas recorded in this diary:

- 1. Cauchy Integral Formula:** Gauss discovers it in 1811, 16 years before Cauchy.
- 2. Non-Euclidean Geometry:** After failing to prove Euclid's fifth postulate at the age of 15, Gauss came to the conclusion that the Euclidean form of geometry cannot be the only one possible.
- 3. Elliptic Functions:** Gauss had found many of the results of Abel and Jacobi (the two main contributors to the subject) before these men were born. The facts became known partly through Jacobi himself. His attention was caught by a cryptic passage in the *Disquisitiones*, whose meaning can only be understood if one knows something about elliptic functions. He visited Gauss on several occasions to verify his suspicions and tell him about his own most recent discoveries, and each time Gauss pulled 30-year-old manuscripts out of his desk and showed Jacobi what Jacobi had just shown him. After a week's visit with Gauss in 1840, Jacobi wrote to his brother, "Mathematics would be in a very different position if practical astronomy had not diverted this colossal genius from his glorious career."

A possible explanation for not publishing such important ideas is suggested by his comments in a letter to Bolyai: "It is not knowledge but the act of learning, not possession but the act of getting there, which grants the greatest enjoyment. When I have clarified and exhausted a subject, then I turn away from it in order to go into darkness again." His was the temperament of an explorer who is reluctant to take the time to write an account of his

last expedition when he could be starting another. As it was, Gauss wrote a great deal, but to have published every fundamental discovery he made in a form satisfactory to himself would have required several long lifetimes.

A third relation can be obtained by making the substitution $w = (1 - z)^{\gamma - \alpha - \beta} u$. This leads to a hypergeometric equation for u with $\alpha_1 = \gamma - \alpha$, $\beta_1 = \gamma - \beta$, and $\gamma_1 = \gamma$. Furthermore, w is analytic at $z = 0$, and $w(0) = 1$. We conclude that $w = F(\alpha, \beta; \gamma; z)$. We therefore have the identity

$$F(\alpha, \beta; \gamma; z) = (1 - z)^{\gamma - \alpha - \beta} F(\gamma - \alpha, \gamma - \beta; \gamma; z). \quad (15.25)$$

To obtain the canonical basis at $z = 1$, we make the substitution $t = 1 - z$, and note that the result is again the HGDE, with $\alpha_1 = \alpha$, $\beta_1 = \beta$, and $\gamma_1 = \alpha + \beta - \gamma + 1$. It follows from Eq. (15.24) that

$$w_3(z) \equiv F(\alpha, \beta; \alpha + \beta - \gamma + 1; 1 - z), \quad (15.26)$$

$$w_4(z) \equiv (1 - z)^{\gamma - \alpha - \beta} F(\gamma - \alpha, \gamma - \beta; \gamma - \alpha - \beta + 1; 1 - z)$$

form a canonical basis of solutions to the HGDE at $z = 1$.

A symmetry of the hypergeometric function that is easily obtained from the HGDE is

$$F(\alpha, \beta; \gamma; z) = F(\beta, \alpha; \gamma; z). \quad (15.27)$$

The six functions

$$F(\alpha \pm 1, \beta; \gamma; z), \quad F(\alpha, \beta \pm 1; \gamma; z), \quad F(\alpha, \beta; \gamma \pm 1; z)$$

are called hypergeometric functions **contiguous to** $F(\alpha, \beta; \gamma; z)$. The discussion above showed how to obtain the basis of solutions at $z = 1$ from the regular solution to the HDE $z = 0$, $F(\alpha, \beta; \gamma; z)$. We can show that the basis of solutions at $z = \infty$ can also be obtained from the hypergeometric function.

Equation (15.16) suggests a function of the form

$$v(z) = z^r F\left(\alpha_1, \beta_1; \gamma_1; \frac{1}{z}\right) \equiv z^r w\left(\frac{1}{z}\right) \Rightarrow w(z) = z^r v\left(\frac{1}{z}\right), \quad (15.28)$$

where r , α_1 , β_1 , and γ_1 are to be determined. Since $w(z)$ is a solution of the HGDE, v will satisfy the following DE (see Problem 15.15):

$$z(1 - z)v'' + [1 - \alpha - \beta - 2r - (2 - \gamma - 2r)z]v' - \left[r^2 - r + r\gamma - \frac{1}{z}(r + \alpha)(r + \beta)\right]v = 0. \quad (15.29)$$

This reduces to the HGDE if $r = -\alpha$ or $r = -\beta$. For $r = -\alpha$, the parameters become $\alpha_1 = \alpha$, $\beta_1 = 1 + \alpha - \gamma$, and $\gamma_1 = \alpha - \beta + 1$. For $r = -\beta$, the parameters are $\alpha_1 = \beta$, $\beta_1 = 1 + \beta - \gamma$, and $\gamma_1 = \beta - \alpha + 1$. Thus,

$$\begin{aligned} v_1(z) &= z^{-\alpha} F\left(\alpha, 1 + \alpha - \gamma; \alpha - \beta + 1; \frac{1}{z}\right), \\ v_2(z) &= z^{-\beta} F\left(\beta, 1 + \beta - \gamma; \beta - \alpha + 1; \frac{1}{z}\right) \end{aligned} \quad (15.30)$$

form a canonical basis of solutions for the HGDE that are valid about $z = \infty$.

As the preceding discussion suggests, it is possible to obtain many relations among the hypergeometric functions with different parameters and independent variables. In fact, the nineteenth-century mathematician Kummer showed that there are 24 different (but linearly dependent, of course) solutions to the HGDE. These are collectively known as **Kummer's solutions**, and six of them were derived above. Another important relation (shown in Problem 15.16) is that

Kummer's solutions

$$z^{\alpha-\gamma}(1-z)^{\gamma-\alpha-\beta}F\left(\gamma-\alpha, 1-\alpha; 1-\alpha+\beta; \frac{1}{z}\right) \quad (15.31)$$

also solves the HGDE.

Many of the functions that occur in mathematical physics are related to the hypergeometric function. Even some of the common elementary functions can be expressed in terms of the hypergeometric function with appropriate parameters. For example, when $\beta = \gamma$, we obtain

$$F(\alpha, \beta; \beta; z) = \sum_{k=0}^{\infty} \frac{\Gamma(\alpha+k)}{\Gamma(\alpha)\Gamma(k+1)} z^k = (1-z)^{-\alpha}.$$

Similarly,

$$F\left(\frac{1}{2}, \frac{1}{2}; \frac{3}{2}; z^2\right) = \frac{\sin^{-1}z}{z}, \quad \text{and} \quad F(1, 1; 2; -z) = \frac{\ln(1+z)}{z}.$$

However, the real power of the hypergeometric function is that it encompasses almost all of the nonelementary functions encountered in physics. Let us look briefly at a few of these.

Jacobi functions are solutions of the DE

Jacobi functions

$$(1-x^2)\frac{d^2u}{dx^2} + [\beta-\alpha-(\alpha+\beta+2)x]\frac{du}{dx} + \lambda(\lambda+\alpha+\beta+1)u = 0. \quad (15.32)$$

Defining $x = 1 - 2z$ changes this DE into the HGDE with parameters $\alpha_1 = \lambda$, $\beta_1 = \lambda + \alpha + \beta + 1$, and $\gamma_1 = 1 + \alpha$. The solutions of Eq. (15.32), called the **Jacobi functions of the first kind**, are, with appropriate normalization,

$$P_{\lambda}^{(\alpha,\beta)}(z) = \frac{\Gamma(\lambda+\alpha+1)}{\Gamma(\lambda+1)\Gamma(\alpha+1)} F\left(-\lambda, \lambda+\alpha+\beta+1; 1+\alpha; \frac{1-z}{2}\right).$$

When $\lambda = n$, a nonnegative integer, the Jacobi function turns into a polynomial of degree n with the following expansion:

$$P_n^{(\alpha,\beta)}(z) = \frac{\Gamma(n+\alpha+1)}{\Gamma(n+1)\Gamma(n+\alpha+\beta+1)} \times \sum_{k=0}^n \frac{\Gamma(n+\alpha+\beta+k+1)}{\Gamma(\alpha+k+1)} \left(\frac{z-1}{2}\right)^k.$$

These are the Jacobi polynomials discussed in Chap. 8. In fact, the DE satisfied by $P_n^{(\alpha,\beta)}(x)$ of Chap. 8 is identical to Eq. (15.32). Note that the transformation $x = 1 - 2z$ translates the points $z = 0$ and $z = 1$ to the points $x = 1$ and $x = -1$, respectively. Thus the regular singular points of the Jacobi functions of the first kind are at ± 1 and ∞ .

A second, linearly independent, solution of Eq. (15.32) is obtained by using (15.31). These are called the **Jacobi functions of the second kind**:

$$Q_\lambda^{(\alpha,\beta)}(z) = \frac{2^{\lambda+\alpha+\beta} \Gamma(\lambda + \alpha + 1) \Gamma(\lambda + \beta + 1)}{\Gamma(2\lambda + \alpha + \beta + 2)(z - 1)^{\lambda+\alpha+1}(z + 1)^\beta} \times F\left(\lambda + \alpha + 1, \lambda + 1; 2\lambda + \alpha + \beta + 2; \frac{2}{1 - z}\right). \quad (15.33)$$

Gegenbauer functions **Gegenbauer functions**, or ultraspherical functions, are special cases of Jacobi functions for which $\alpha = \beta = \mu - \frac{1}{2}$. They are defined by

$$C_\lambda^\mu(z) = \frac{\Gamma(\lambda + 2\mu)}{\Gamma(\lambda + 1)\Gamma(2\mu)} F\left(-\lambda, \lambda + 2\mu; \mu + \frac{1}{2}; \frac{1 - z}{2}\right). \quad (15.34)$$

Note the change in the normalization constant. Linearly independent Gegenbauer functions “of the second kind” can be obtained from the Jacobi functions of the second kind by the substitution $\alpha = \beta = \mu - \frac{1}{2}$.

Another special case of the Jacobi functions is obtained when $\alpha = \beta = 0$. Those obtained from the Jacobi functions of the first kind are called

Legendre functions **Legendre functions of the first kind**:

$$P_\lambda(z) \equiv P_\lambda^{(0,0)}(z) = C_\lambda^{1/2} = F\left(-\lambda, \lambda + 1; 1; \frac{1 - z}{2}\right). \quad (15.35)$$

Legendre functions of the second kind are obtained from the Jacobi functions of the second kind in a similar way:

$$Q_\lambda(z) = \frac{2^\lambda \Gamma^2(\lambda + 1)}{\Gamma(2\lambda + 2)(z - 1)^{\lambda+1}} F\left(\lambda + 1, \lambda + 1; 2\lambda + 2; \frac{2}{1 - z}\right).$$

Other functions derived from the Jacobi functions are obtained similarly (see Chap. 8).

15.5 Confluent Hypergeometric Functions

The transformation $x = 1 - 2z$ translates the regular singular points of the HGDE by a finite amount. Consequently, the new functions still have two regular singular points, $z = \pm 1$, in the complex plane. In some physical cases of importance, only the origin, corresponding to $r = 0$ in spherical coordinates (typically the location of the source of a central force), is the singular point. If we want to obtain a differential equation consistent with such a case, we have to “push” the singular point $z = 1$ to infinity. This can

be achieved by making the substitution $t = rz$ in the HGDE and taking the limit $r \rightarrow \infty$. The substitution yields

$$\frac{d^2w}{dt^2} + \left(\frac{\gamma}{t} + \frac{1 - \gamma + \alpha + \beta}{t - r} \right) \frac{dw}{dt} + \frac{\alpha\beta}{t(t-r)}w = 0. \quad (15.36)$$

If we blindly take the limit $r \rightarrow \infty$ with α , β , and γ remaining finite, Eq. (15.36) reduces to $\ddot{w} + (\gamma/t)\dot{w} = 0$, an elementary FODE in w . To obtain a nonelementary DE, we need to manipulate the parameters, to let some of them tend to infinity. We want γ to remain finite, because otherwise the coefficient of dw/dt will blow up. We therefore let β or α tend to infinity. The result will be the same either way because α and β appear symmetrically in the equation. It is customary to let $\beta = r \rightarrow \infty$. In that case, Eq. (15.36) becomes

$$\frac{d^2w}{dt^2} + \left(\frac{\gamma}{t} - 1 \right) \frac{dw}{dt} - \frac{\alpha}{t}w = 0.$$

Multiplying by t and changing the independent variable back to z yields

$$zw''(z) + (\gamma - z)w'(z) - \alpha w(z) = 0. \quad (15.37)$$

confluent
hypergeometric DE

This is called the **confluent hypergeometric DE** (CHGDE).

Since $z = 0$ is still a regular singular point of the CHGDE, we can obtain expansions about that point. The characteristic exponents are 0 and $1 - \gamma$, as before. Thus, there is an analytic solution (corresponding to the characteristic exponent 0) to the CHGDE at the origin, which is called the **confluent hypergeometric function** and denoted by $\Phi(\alpha; \gamma; z)$. Since $z = 0$ is the only possible (finite) singularity of the CHGDE, $\Phi(\alpha; \gamma; z)$ is an entire function.

We can obtain the series expansion of $\Phi(\alpha; \gamma; z)$ directly from Eq. (15.22) and the fact that $\Phi(\alpha; \gamma; z) = \lim_{\beta \rightarrow 0} F(\alpha, \beta; \gamma; z/\beta)$. The result is

$$\Phi(\alpha; \gamma; z) = \frac{\Gamma(\gamma)}{\Gamma(\alpha)} \sum_{k=0}^{\infty} \frac{\Gamma(\alpha + k)}{\Gamma(k + 1)\Gamma(\gamma + k)} z^k. \quad (15.38)$$

confluent
hypergeometric function
and series

This is called the **confluent hypergeometric series**. An argument similar to the one given in the case of the hypergeometric function shows that

Box 15.5.1 *The confluent hypergeometric function $\Phi(\alpha; \gamma; z)$ reduces to a polynomial when α is a negative integer.*

A second solution of the CHGDE can be obtained, as for the HGDE. If $1 - \gamma$ is not an integer, then by taking the limit $\beta \rightarrow \infty$ of Eq. (15.24), we obtain the second solution $z^{1-\gamma} \Phi(\alpha - \gamma + 1, 2 - \gamma; z)$. Thus,

Proposition 15.5.2 *Any solution of the CHGDE can be written as a linear combination of $\Phi(\alpha; \gamma; z)$ and $z^{1-\gamma} \Phi(\alpha - \gamma + 1, 2 - \gamma; z)$.*

15.5.1 Hydrogen-Like Atoms

The time-independent Schrödinger equation for a central potential, in units in which $\hbar = m = 1$, is $-\frac{1}{2}\nabla^2\Psi + V(r)\Psi = E\Psi$. For the case of hydrogen-like atoms, $V(r) = -Ze^2/r$, where Z is the atomic number, and the equation reduces to

$$\nabla^2\Psi + \left(2E + \frac{2Ze^2}{r}\right)\Psi = 0.$$

The radial part of this equation is given by Eq. (13.14) with $f(r) = 2E + 2Ze^2/r$. Defining $u = rR(r)$, we may write

$$\frac{d^2u}{dr^2} + \left(\lambda + \frac{a}{r} - \frac{b}{r^2}\right)u = 0, \quad (15.39)$$

where $\lambda = 2E$, $a = 2Ze^2$, and $b = l(l+1)$. This equation can be further simplified by defining $r \equiv kz$ (k is an arbitrary constant to be determined later):

$$\frac{d^2u}{dz^2} + \left(\lambda k^2 + \frac{ak}{z} - \frac{b}{z^2}\right)u = 0.$$

Choosing $\lambda k^2 = -\frac{1}{4}$ and introducing $\alpha \equiv a/(2\sqrt{-\lambda})$ yields

$$\frac{d^2u}{dz^2} + \left(-\frac{1}{4} + \frac{\alpha}{z} - \frac{b}{z^2}\right)u = 0.$$

Equations of this form can be transformed into the CHGDE by making the substitution $u(z) = z^\mu e^{-\nu z} f(z)$. It then follows that

$$\frac{d^2f}{dz^2} + \left(\frac{2\mu}{z} - 2\nu\right)\frac{df}{dz} + \left[-\frac{1}{4} + \frac{\mu(\mu-1)}{z^2} - \frac{2\mu\nu}{z} + \frac{\alpha}{z} - \frac{b}{z^2} + \nu^2\right]f = 0.$$

Choosing $\nu^2 = \frac{1}{4}$ and $\mu(\mu-1) = b$ reduces this equation to

$$f'' + \left(\frac{2\mu}{z} - 2\nu\right)f' - \frac{2\mu\nu - \alpha}{z}f = 0,$$

which is in the form of (15.37).

quantization of the
energy of the hydrogen
atom

On physical grounds, we expect $u(z) \rightarrow 0$ as $z \rightarrow \infty$.⁴ Therefore, $\nu = \frac{1}{2}$. Similarly, with $\mu(\mu-1) = b = l(l+1)$, we obtain the two possibilities $\mu = -l$ and $\mu = l+1$. Again on physical grounds, we demand that $u(0)$ be finite (the wave function must not blow up at $r = 0$). This implies⁵ that $\mu = l+1$. We thus obtain

$$f'' + \left[\frac{2(l+1)}{z} - 1\right]f' - \frac{l+1-\alpha}{z}f = 0.$$

⁴This is because the volume integral of $|\Psi|^2$ over all space must be finite. The radial part of this integral is simply the integral of $r^2 R^2(r) = u^2(r)$. This latter integral will not be finite unless $u(\infty) = 0$.

⁵Recall that μ is the exponent of $z = r/k$.

Multiplying by z gives

$$zf'' + [2(l+1) - z]f' - (l+1 - \alpha)f = 0.$$

Comparing this with Eq. (15.37) shows that f is proportional to $\Phi(l+1 - \alpha, 2l+2; z)$. Thus, the solution of (15.39) can be written as

$$u(z) = Cz^{l+1}e^{-z/2}\Phi(l+1 - \alpha, 2l+2; z).$$

An argument similar to that used in Problem 14.22 will reveal that the product $e^{-z/2}\Phi(l+1 - \alpha, 2l+2; z)$ will be infinite unless the power series representing Φ terminates (becomes a polynomial). It follows from Box 15.5.1 that this will take place if

$$l+1 - \alpha = -N \quad (15.40)$$

for some integer $N \geq 0$. In that case we obtain the Laguerre polynomials

$$L_N^j \equiv \frac{\Gamma(N+j+1)}{\Gamma(N+1)\Gamma(j+1)}\Phi(-N, j+1; z), \quad \text{where } j = 2l+1.$$

Condition (15.40) is the quantization rule for the energy levels of a hydrogen-like atom. Writing everything in terms of the original parameters and defining $n = N + l + 1$ yields—after restoring all the m 's and the \hbar 's—the energy levels of a hydrogen-like atom:

$$E = -\frac{Z^2me^4}{2\hbar^2n^2} = -Z^2\left(\frac{mc^2}{2}\right)\alpha^2\frac{1}{n^2},$$

where $\alpha = e^2/(\hbar c) = 1/137$ is the **fine-structure constant**.

fine-structure constant

The radial wave functions can now be written as

$$R_{n,l}(r) = \frac{u_{n,l}(r)}{r} = Cr^l e^{-Zr/(na_0)}\Phi\left(-n+l+1, 2l+2; \frac{2Zr}{na_0}\right),$$

where

$$a_0 = \hbar^2/(me^2) = 0.529 \times 10^{-8} \text{ cm}$$

is the **Bohr radius**.

Bohr radius

Historical Notes

Friedrich Wilhelm Bessel (1784–1846) showed no signs of unusual academic ability in school, although he did show a liking for mathematics and physics. He left school intending to become a merchant's apprentice, a desire that soon materialized with a seven-year unpaid apprenticeship with a large mercantile firm in Bremen. The young Bessel proved so adept at accounting and calculation that he was granted a small salary, with raises, after only the first year. An interest in foreign trade led Bessel to study geography and languages at night, astonishingly learning to read and write English in only three months. He also studied navigation in order to qualify as a cargo officer aboard ship, but his innate curiosity soon compelled him to investigate astronomy at a more fundamental level. Still serving his apprenticeship, Bessel learned to observe the positions of stars with sufficient accuracy to determine the longitude of Bremen, checking his results against professional astronomical journals. He then tackled the more formidable problem of determining the orbit of Halley's comet from published observations. After seeing the close



Friedrich Wilhelm Bessel
1784–1846

agreement between Bessel's calculations and those of Halley, the German astronomer Olbers encouraged Bessel to improve his already impressive work with more observations. The improved calculations, an achievement tantamount to a modern doctoral dissertation, were published with Olbers's recommendation. Bessel later received appointments with increasing authority at observatories near Bremen and in Königsberg, the latter position being accompanied by a professorship. (The title of doctor, required for the professorship, was granted by the University of Göttingen on the recommendation of Gauss.)

Bessel proved himself an excellent observational astronomer. His careful measurements coupled with his mathematical aptitude allowed him to produce accurate positions for a number of previously mapped stars, taking account of instrumental effects, atmospheric refraction, and the position and motion of the observation site. In 1820 he determined the position of the vernal equinox accurate to 0.01 second, in agreement with modern values. His observation of the variation of the proper motion of the stars Sirius and Procyon led him to posit the existence of nearby, large, low-luminosity stars called dark companions. Between 1821 and 1833 he catalogued the positions of about 75,000 stars, publishing his measurements in detail. One of his most important contributions to astronomy was the determination of the distance to a star using parallax. This method uses triangulation, or the determination of the apparent positions of a distant object viewed from two points a known distance apart, in this case two diametrically opposed points of the Earth's orbit. The angle subtended by the baseline of Earth's orbit, viewed from the star's perspective, is known as the star's parallax. Before Bessel's measurement, stars were assumed to be so distant that their parallaxes were too small to measure, and it was further assumed that bright stars (thought to be nearer) would have the largest parallax. Bessel correctly reasoned that stars with large proper motions were more likely to be nearby ones and selected such a star, 61 Cygni, for his historic measurement. His measured parallax for that star differs by less than 8 % from the currently accepted value.

Given such an impressive record in astronomy, it seems only fitting that the famous functions that bear Bessel's name grew out of his investigations of perturbations in planetary systems. He showed that such perturbations could be divided into two effects and treated separately: the obvious direct attraction due to the perturbing planet and an indirect effect caused by the sun's response to the perturber's force. The so-called Bessel functions then appear as coefficients in the series treatment of the indirect perturbation. Although special cases of Bessel functions were discovered by Bernoulli, Euler, and Lagrange, the systematic treatment by Bessel clearly established his preeminence, a fitting tribute to the creator of the most famous functions in mathematical physics.

15.5.2 Bessel Functions

Bessel differential equation The **Bessel differential equation** is usually written as

$$w'' + \frac{1}{z}w' + \left(1 - \frac{\nu^2}{z^2}\right)w = 0. \quad (15.41)$$

As in the example above, the substitution $w = z^\mu e^{-\eta z} f(z)$ transforms (15.41) into

$$\frac{d^2 f}{dz^2} + \left(\frac{2\mu + 1}{z} - 2\eta\right) \frac{df}{dz} + \left[\frac{\mu^2 - \nu^2}{z^2} - \frac{\eta(2\mu + 1)}{z} + \eta^2 + 1\right] f = 0,$$

which, if we set $\mu = \nu$ and $\eta = i$, reduces to

$$f'' + \left(\frac{2\nu + 1}{z} - 2i\right) f' - \frac{(2\nu + 1)i}{z} f = 0.$$

Making the further substitution $2iz = t$, and multiplying out by t , we obtain

$$t \frac{d^2 f}{dt^2} + (2\nu + 1 - t) \frac{df}{dt} - \left(\nu + \frac{1}{2} \right) f = 0,$$

which is in the form of (15.37) with $\alpha = \nu + \frac{1}{2}$ and $\gamma = 2\nu + 1$.

Thus, solutions of the Bessel equation, Eq. (15.41), can be written as constant multiples of $z^\nu e^{-iz} \Phi(\nu + \frac{1}{2}, 2\nu + 1; 2iz)$. With proper normalization, we define the **Bessel function of the first kind of order ν** as

Bessel function of the first kind

$$J_\nu(z) = \frac{1}{\Gamma(\nu + 1)} \left(\frac{z}{2} \right)^\nu e^{-iz} \Phi \left(\nu + \frac{1}{2}, 2\nu + 1; 2iz \right). \quad (15.42)$$

Using Eq. (15.38) and the expansion for e^{-iz} , we can show that

$$J_\nu(z) = \left(\frac{z}{2} \right)^\nu \sum_{k=0}^{\infty} \frac{(-1)^k}{k! \Gamma(\nu + k + 1)} \left(\frac{z}{2} \right)^{2k}. \quad (15.43)$$

The second linearly independent solution can be obtained as usual and is proportional to

$$\begin{aligned} z^{1-(2\nu+1)} \left(\frac{z}{2} \right)^\nu e^{-iz} \Phi \left(\nu + \frac{1}{2} - (2\nu + 1) + 1, 2 - (2\nu + 1); 2iz \right) \\ = C \left(\frac{z}{2} \right)^{-\nu} e^{-iz} \Phi \left(-\nu + \frac{1}{2}, -2\nu + 1; 2iz \right) = C J_{-\nu}(z), \end{aligned}$$

provided that $1 - \gamma = 1 - (2\nu + 1) = -2\nu$ is not an integer. When ν is an integer, $J_{-n}(z) = (-1)^n J_n(z)$ (see Problem 15.25). Thus, when ν is a noninteger, the most general solution is of the form $AJ_\nu(z) + BJ_{-\nu}(z)$.

How do we find a second linearly independent solution when ν is an integer n ? We first define

$$Y_\nu(z) = \frac{J_\nu(z) \cos \nu\pi - J_{-\nu}(z)}{\sin \nu\pi}, \quad (15.44)$$

called the Bessel function of the second kind, or the **Neumann function**. For noninteger ν this is simply a linear combination of the two linearly independent solutions. For integer ν the function is indeterminate. Therefore, we use l'Hôpital's rule and define

Bessel function of the second kind, or Neumann function

$$Y_n(z) \equiv \lim_{\nu \rightarrow n} Y_\nu(z) = \frac{1}{\pi} \lim_{\nu \rightarrow n} \left[\frac{\partial J_\nu}{\partial \nu} - (-1)^n \frac{\partial J_{-\nu}}{\partial \nu} \right].$$

Equation (15.43) yields

$$\frac{\partial J_\nu}{\partial \nu} = J_\nu(z) \ln \left(\frac{z}{2} \right) - \left(\frac{z}{2} \right)^\nu \sum_{k=0}^{\infty} (-1)^k \frac{\Psi(\nu + k + 1)}{k! \Gamma(\nu + k + 1)} \left(\frac{z}{2} \right)^{2k},$$

where $\Psi(z) = (d/dz) \ln \Gamma(z)$. Similarly,

$$\frac{\partial J_{-\nu}}{\partial \nu} = -J_{-\nu}(z) \ln \left(\frac{z}{2} \right) + \left(\frac{z}{2} \right)^{-\nu} \sum_{k=0}^{\infty} \frac{\Psi(-\nu + k + 1)}{k! \Gamma(-\nu + k + 1)} \left(\frac{z}{2} \right)^{2k}.$$

Substituting these expressions in the definition of $Y_n(z)$ and using $J_{-n}(z) = (-1)^n J_n(z)$, we obtain

$$Y_n(z) = \frac{2}{\pi} J_n(z) \ln\left(\frac{z}{2}\right) - \frac{1}{\pi} \left(\frac{z}{2}\right)^n \sum_{k=0}^{\infty} (-1)^k \frac{\Psi(n+k+1)}{k! \Gamma(n+k+1)} \left(\frac{z}{2}\right)^{2k} - \frac{1}{\pi} \left(\frac{z}{2}\right)^{-n} (-1)^n \sum_{k=0}^{\infty} (-1)^k \frac{\Psi(k-n+1)}{k! \Gamma(k-n+1)} \left(\frac{z}{2}\right)^{2k}. \quad (15.45)$$

The natural log term is indicative of the solution suggested by Theorem 15.2.6. Since $Y_\nu(z)$ is linearly independent of $J_\nu(z)$ for any ν , integer or noninteger, it is convenient to consider $\{J_\nu(z), Y_\nu(z)\}$ as a basis of solutions for the Bessel equation.

Bessel function of the third kind or Hankel function

Another basis of solutions is defined as

$$H_\nu^{(1)}(z) = J_\nu(z) + iY_\nu(z), \quad H_\nu^{(2)}(z) = J_\nu(z) - iY_\nu(z), \quad (15.46)$$

which are called Bessel functions of the third kind, or **Hankel functions**.

Replacing z by iz in the Bessel equation yields

$$\frac{d^2w}{dz^2} + \frac{1}{z} \frac{dw}{dz} - \left(1 + \frac{\nu^2}{z^2}\right)w = 0,$$

modified Bessel functions

whose basis of solutions consists of multiples of $J_\nu(iz)$ and $J_{-\nu}(iz)$. Thus, the **modified Bessel functions of the first kind** are defined as

$$I_\nu(z) \equiv e^{-i\pi\nu/2} J_\nu(iz) = \left(\frac{z}{2}\right)^\nu \sum_{k=0}^{\infty} \frac{1}{k! \Gamma(\nu+k+1)} \left(\frac{z}{2}\right)^{2k}.$$

Similarly, the **modified Bessel functions of the second kind** are defined as

$$K_\nu(z) = \frac{\pi}{2 \sin \nu\pi} [I_{-\nu}(z) - I_\nu(z)].$$

When ν is an integer n , $I_n = I_{-n}$, and K_n is indeterminate. Thus, we define $K_n(z)$ as $\lim_{\nu \rightarrow n} K_\nu(z)$. This gives

$$K_n(z) = \frac{(-1)^n}{2} \lim_{\nu \rightarrow n} \left[\frac{\partial I_{-\nu}}{\partial \nu} - \frac{\partial I_\nu}{\partial \nu} \right],$$

which has the power-series representation

$$K_n(z) = (-1)^{n+1} I_n(z) \ln\left(\frac{z}{2}\right) + \frac{1}{2} (-1)^n \left(\frac{z}{2}\right)^n \sum_{k=0}^{\infty} \frac{\Psi(n+k+1)}{k! \Gamma(n+k+1)} \left(\frac{z}{2}\right)^{2k} + \frac{1}{2} (-1)^n \left(\frac{z}{2}\right)^{-n} \sum_{k=0}^{\infty} \frac{\Psi(k-n+1)}{k! \Gamma(k-n+1)} \left(\frac{z}{2}\right)^{2k}.$$

We can obtain a recurrence relation for solutions of the Bessel equation as follows. If $Z_\nu(z)$ is a solution of order ν , then (see Problem 15.28) recurrence relation for solutions of the Bessel DE

$$Z_{\nu+1} = C_1 z^\nu \frac{d}{dz} [z^{-\nu} Z_\nu(z)] \quad \text{and} \quad Z_{\nu-1} = C_2 z^{-\nu} \frac{d}{dz} [z^\nu Z_\nu(z)].$$

If the constants are chosen in such a way that Z_ν , $Z_{-\nu}$, $Z_{\nu+1}$, and $Z_{\nu-1}$ satisfy their appropriate series expansions, then $C_1 = -1$ and $C_2 = 1$. Carrying out the differentiation in the equations for $Z_{\nu+1}$ and $Z_{\nu-1}$, we obtain

$$Z_{\nu+1} = \frac{\nu}{z} Z_\nu - \frac{dZ_\nu}{dz}, \quad Z_{\nu-1} = \frac{\nu}{z} Z_\nu + \frac{dZ_\nu}{dz}. \quad (15.47)$$

Adding these two equations yields the recursion relation

$$Z_{\nu-1}(z) + Z_{\nu+1}(z) = \frac{2\nu}{z} Z_\nu(z), \quad (15.48)$$

where $Z_\nu(z)$ can be any of the three kinds of Bessel functions.

15.6 Problems

15.1 Show that the solution of $w' + w/z^2 = 0$ has an essential singularity at $z = 0$.

15.2 Derive the recursion relation of Eq. (15.7) and express it in terms of the indicial polynomial, as in Eq. (15.9).

15.3 Find the characteristic exponent associated with the solution of

$$w'' + p(z)w' + q(z)w = 0$$

at an ordinary point [a point at which $p(z)$ and $q(z)$ have no poles]. How many solutions can you find?

15.4 The Laplace equation in electrostatics when separated in spherical coordinates yields a DE in the radial coordinate given by

$$\frac{d}{dx} \left(x^2 \frac{dy}{dx} \right) - n(n+1)y = 0 \quad \text{for } n \geq 0.$$

Starting with an infinite series of the form (15.6), show that the two independent solutions of this ODE are of the form x^n and x^{-n-1} .

15.5 Find the indicial polynomial, characteristic exponents, and recursion relation at both of the regular singular points of the Legendre equation,

$$w'' - \frac{2z}{1-z^2} w' + \frac{\alpha}{1-z^2} w = 0.$$

What is a_k , the coefficient of the Laurent expansion, for the point $z = +1$?

15.6 Show that the substitution $z = 1/t$ transforms Eq. (15.13) into Eq. (15.14).

15.7 Obtain the indicial polynomial of Eq. (15.14) for expansion about $t = 0$.

15.8 Show that Riemann DE represents the most general second order Fuchsian DE.

15.9 Derive the indicial equation for the Riemann DE.

15.10 Show that the transformation $v(z) = z^\lambda(z-1)^\mu w(z)$ changes the pairs of characteristic exponents (λ_1, λ_2) , (μ_1, μ_2) , and (ν_1, ν_2) for the Riemann DE to $(\lambda_1 + \lambda, \lambda_2 + \lambda)$, $(\mu_1 + \mu, \mu_2 + \mu)$, and $(\nu_1 - \lambda - \mu, \nu_2 - \lambda - \mu)$.

15.11 Go through the steps leading to Eqs. (15.24), (15.25), and (15.26).

15.12 Show that the elliptic function of the first kind, defined as

$$K(z) = \int_0^{\pi/2} \frac{d\theta}{\sqrt{1 - z^2 \sin^2 \theta}},$$

can be expressed as $(\pi/2)F(\frac{1}{2}, \frac{1}{2}; 1; z^2)$.

15.13 By differentiating the hypergeometric series, show that

$$\frac{d^n}{dz^n} F(\alpha, \beta; \gamma; z) = \frac{\Gamma(\alpha + n)\Gamma(\beta + n)\Gamma(\gamma)}{\Gamma(\alpha)\Gamma(\beta)\Gamma(\gamma + n)} F(\alpha + n, \beta + n; \gamma + n; z).$$

15.14 Use direct substitution in the hypergeometric series to show that

$$F(-\alpha, \beta; \beta; -z) = (1+z)^\alpha, \quad F\left(\frac{1}{2}, \frac{1}{2}; \frac{3}{2}; z^2\right) = \frac{1}{z} \sin^{-1} z,$$

$$F(1, 1; 2; -z) = \frac{1}{z} \ln(1+z).$$

15.15 Show that the substitution $v(z) = z^r w(1/z)$ [see Eq. (15.28)] transforms the HGDE into Eq. (15.29).

15.16 Consider the function $v(z) \equiv z^r(1-z)^s F(\alpha_1, \beta_1; \gamma_1; 1/z)$ and assume that it is a solution of HGDE. Find a relation among r, s, α_1, β_1 , and γ_1 such that $v(z)$ is written in terms of three parameters rather than five. In particular, show that one possibility is

$$v(z) = z^{\alpha-\gamma} (1-z)^{\gamma-\alpha-\beta} F(\gamma-\alpha, 1-\alpha; 1+\beta-\alpha; 1/z).$$

Find all such possibilities.

15.17 Show that the Jacobi functions are related to the hypergeometric functions.

15.18 Derive the expression for the Jacobi function of the second kind as given in Eq. (15.33).

15.19 Show that $z = \infty$ is not a regular singular point of the CHGDE.

15.20 Derive the confluent hypergeometric series from hypergeometric series.

15.21 Show that the **Weber-Hermite equation**, $u'' + (v + \frac{1}{2} - \frac{1}{4}z^2)u = 0$ can be transformed into the CHGDE. Hint: Make the substitution $u(z) = \exp(-\frac{1}{4}z^2)v(z)$. Weber-Hermite equation

15.22 The linear combination

$$\begin{aligned} \Psi(\alpha, \gamma; z) \equiv & \frac{\Gamma(1-\gamma)}{\Gamma(\alpha-\gamma+1)} \Phi(\alpha, \gamma; z) \\ & + \frac{\Gamma(\gamma-1)}{\Gamma(\alpha)} z^{1-\gamma} \Phi(\alpha-\gamma+1, 2-\gamma; z) \end{aligned}$$

is also a solution of the CHGDE. Show that the Hermite polynomials can be written as

$$H_n\left(\frac{z}{\sqrt{2}}\right) = 2^n \Psi\left(-\frac{n}{2}, \frac{1}{2}; \frac{z^2}{2}\right).$$

15.23 Verify that the error function $\operatorname{erf}(z) = \int_0^z e^{-t^2} dt$ satisfies the relation $\operatorname{erf}(z) = z \Phi\left(\frac{1}{2}, \frac{3}{2}; -z^2\right)$.

15.24 Derive the series expansion of the Bessel function of the first kind from that of the confluent hypergeometric series and the expansion of the exponential. Check your answer by obtaining the same result by substituting the power series directly in the Bessel DE.

15.25 Show that $J_{-n}(z) = (-1)^n J_n(z)$. Hint: Let $\nu = -n$ in the expansion of $J_\nu(z)$ and use $\Gamma(m) = \infty$ for a nonpositive integer m .

15.26 In a potential-free region, the radial part of the Schrödinger equation reduces to

$$\frac{d^2 R}{dr^2} + \frac{2}{r} \frac{dR}{dr} + \left[\lambda - \frac{\alpha}{r^2} \right] R = 0.$$

Write the solutions of this DE in terms of Bessel functions. Hint: Substitute $R = u/\sqrt{r}$. These solutions are called **spherical Bessel functions**.

spherical Bessel
functions

15.27 Theorem 15.2.6 states that under certain conditions, linearly independent solutions of SOLDE at regular singular points exist even though the difference between the characteristic exponents is an integer. An example is the case of Bessel functions of half-odd-integer orders. Evaluate the Wronskian of the two linearly independent solutions, J_ν and $J_{-\nu}$, of the Bessel equation

and show that it vanishes *only if* ν is an integer. This shows, in particular, that $J_{n+1/2}$ and $J_{-n-1/2}$ are linearly independent. Hint: Consider the value of the Wronskian at $z = 0$, and use the formula $\Gamma(\nu)\Gamma(1 - \nu) = \pi / \sin \nu\pi$.

15.28 Show that $z^{\pm\nu}(d/dz)[z^{\mp\nu}Z_\nu(z)]$ is a solution of the Bessel equation of order $\nu \pm 1$ if Z_ν is a solution of order ν .

15.29 Use the recursion relation of Eq. (15.47) to prove that

$$\begin{aligned}\left(\frac{1}{z} \frac{d}{dz}\right)^m [z^\nu Z_\nu(z)] &= z^{\nu-m} Z_{\nu-m}(z), \\ \left(\frac{1}{z} \frac{d}{dz}\right)^m [z^{-\nu} Z_\nu(z)] &= (-1)^m z^{-\nu-m} Z_{\nu+m}(z).\end{aligned}$$

15.30 Using the series expansion of the Bessel function, write $J_{1/2}(z)$ and $J_{-1/2}(z)$ in terms of elementary functions. Hint: First show that

$$\Gamma\left(k + \frac{3}{2}\right) = \sqrt{\pi} (2k + 1)! / (k! 2^{2k+1}).$$

15.31 From the results of the previous two problems, derive the relations

$$\begin{aligned}J_{-n-1/2}(z) &= \sqrt{\frac{2}{\pi}} z^{n+1/2} \left(\frac{1}{z} \frac{d}{dz}\right)^n \left(\frac{\cos z}{z}\right), \\ J_{n+1/2}(z) &= \sqrt{\frac{2}{\pi}} z^{n+1/2} \left(-\frac{1}{z} \frac{d}{dz}\right)^n \left(\frac{\sin z}{z}\right).\end{aligned}$$

15.32 Obtain the following integral identities:

$$\begin{aligned}\text{(a)} \quad & \int z^{\nu+1} J_\nu(z) dz = z^{\nu+1} J_{\nu+1}(z). \\ \text{(b)} \quad & \int z^{-\nu+1} J_\nu(z) dz = -z^{-\nu+1} J_{\nu-1}(z). \\ \text{(c)} \quad & \int z^{\mu+1} J_\nu(z) dz = z^{\mu+1} J_{\nu+1}(z) + (\mu - \nu) z^\mu J_\nu(z) \\ & \quad - (\mu^2 - \nu^2) \int z^{\mu-1} J_\nu(z) dz,\end{aligned}$$

and evaluate

$$\text{(d)} \quad \int z^3 J_0(z) dz.$$

Hint: For (c) write $z^{\mu+1} = z^{\mu-\nu} z^{\nu+1}$ and use integration by parts.

15.33 Use Theorem 15.2.6 and the fact that $J_n(z)$ is entire to show that for integer n , a second solution to the Bessel equation exists and can be written as $Y_n(z) = J_n(z)[f_n(z) + C_n \ln z]$, where $f_n(z)$ is analytic about $z = 0$.

15.34 (a) Show that the Wronskian $W(J_\nu, Z; z)$ of J_ν and any other solution Z of the Bessel equation, satisfies the equation

$$\frac{d}{dz} [zW(J_\nu, Z; z)] = 0.$$

(b) For some constant A , show that

$$\frac{d}{dz} \left[\frac{Z}{J_\nu} \right] = \frac{W(z)}{J_\nu^2(z)} = \frac{A}{zJ_\nu^2(z)}.$$

(c) Show that the general second solution of the Bessel equation can be written as

$$Z_\nu(z) = J_\nu(z) \left[B + A \int \frac{dz}{zJ_\nu^2(z)} \right].$$

15.35 Spherical Bessel functions are defined by

$$f_l(z) \equiv \sqrt{\frac{\pi}{2}} \left(\frac{Z_{l+1/2}(z)}{\sqrt{z}} \right).$$

Let $f_l(z)$ denote a spherical Bessel function “of some kind.” By direct differentiation and substitution in the Bessel equation, show that

$$(a) \quad \frac{d}{dz} [z^{l+1} f_l(z)] = z^{l+1} f_{l-1}(z),$$

$$(b) \quad \frac{d}{dz} [z^{-l} f_l(z)] = -z^{-l} f_{l+1}(z).$$

(c) Combine the results of parts (a) and (b) to derive the recursion relations

$$f_{l-1}(z) + f_{l+1}(z) = \frac{2l+1}{z} f_l(z),$$

$$l f_{l-1}(z) - (l+1) f_{l+1}(z) = (2l+1) \frac{df_l}{dz}.$$

15.36 Show that

$$W(J_\nu, Y_\nu; z) = \frac{2}{\pi z}, \quad W(H_\nu^{(1)}, H_\nu^{(2)}; z) = \frac{4}{i\pi z}.$$

Hint: Use Problem 15.34.

15.37 Verify the following relations:

$$(a) \quad Y_{n+1/2}(z) = (-1)^{n+1} J_{-n-1/2}(z), \quad Y_{-n-1/2}(z) = (-1)^n J_{n+1/2}(z),$$

$$(b) \quad Y_{-\nu}(z) = \sin \nu\pi J_\nu(z) + \cos \nu\pi Y_\nu(z) = \frac{J_\nu(z) - \cos \nu\pi J_{-\nu}(z)}{\sin \nu\pi},$$

$$(c) \quad Y_{-n}(z) = (-1)^n Y_n(z) \quad \text{in the limit } \nu \rightarrow n \text{ in part (b).}$$

15.38 Use the recurrence relation for the Bessel function to show that $J_1(z) = -J_0'(z)$.

15.39 Let $u = J_\nu(\lambda z)$ and $v = J_\nu(\mu z)$. Multiply the Bessel DE for u by v/z and that of v by u/z . Subtract the two equations to obtain

$$(\lambda^2 - \mu^2)zuv = \frac{d}{dz} \left[z \left(u \frac{dv}{dz} - v \frac{du}{dz} \right) \right].$$

- (a) Write the above equation in terms of $J_\nu(\lambda z)$ and $J_\nu(\mu z)$ and integrate both sides with respect to z .
 (b) Now divide both sides by $\lambda^2 - \mu^2$ and take the limit as $\mu \rightarrow \lambda$. You will need to use L'Hôpital's rule.
 (c) Substitute for $J_\nu''(\lambda z)$ from the Bessel DE and simplify to get

$$\int z [J_\nu(\lambda z)]^2 dz = \frac{z^2}{2} \left\{ [J_\nu'(\lambda z)]^2 + \left(1 - \frac{\nu^2}{\lambda^2 z^2} \right) [J_\nu(\lambda z)]^2 \right\}.$$

- (d) Finally, let $\lambda = x_{\nu n}/a$, where $x_{\nu n}$ is the n th root of J_ν , and use Eq. (15.47) to arrive at

$$\int_0^a z J_\nu^2 \left(\frac{x_{\nu n}}{a} z \right) dz = \frac{a^2}{2} J_{\nu+1}^2(x_{\nu n}).$$

15.40 The generating function $g(z, t)$ for Bessel functions of integer order is

$$g(z, t) = \exp \left[\frac{1}{2} z(t - 1/t) \right].$$

To see this, rewrite $g(z, t)$ as $e^{zt/2} e^{-z/2t}$, expand both factors, and write the product as powers of t^n . Now show that the coefficient of t^n is simply $J_n(z)$. Finally, use $J_{-n}(z) = (-1)^n J_n(z)$ to derive the formula

$$\exp \left[\frac{1}{2} z(t - 1/t) \right] = \sum_{n=-\infty}^{\infty} J_n(z) t^n.$$

15.41 Make the substitutions $z = \beta t^\gamma$ and $w = t^\alpha u$ to transform the Bessel DE into

$$t^2 \frac{d^2 u}{dt^2} + (2\alpha + 1)t \frac{du}{dt} + (\beta^2 \gamma^2 t^{2\gamma} + \alpha^2 - \nu^2 \gamma^2) u = 0.$$

Airy's differential equation Now show that **Airy's DE**, $\ddot{u} - tu = 0$, has solutions of the form $J_{1/3}(\frac{2}{3}it^{3/2})$ and $J_{-1/3}(\frac{2}{3}it^{3/2})$.

15.42 Show that the general solution of $\frac{d^2 w}{dt^2} + \frac{e^{2t} - \nu^2}{t^4} w = 0$ is $w = t[AJ_\nu(e^{1/t}) + BY_\nu(e^{1/t})]$.

15.43 Transform $dw/dz + w^2 + z^m = 0$ by making the substitution $w = (d/dz) \ln v$. Now make the further substitutions

$$v = u\sqrt{z} \quad \text{and} \quad t = \frac{2}{m+2} z^{1+(1/2)m}$$

to show that the new DE can be transformed into a Bessel equation of order $1/(m+2)$.

15.44 Starting with the relation

$$\exp\left[\frac{1}{2}x(t-1/t)\right]\exp\left[\frac{1}{2}y(t-1/t)\right] = \exp\left[\frac{1}{2}(x+y)(t-1/t)\right]$$

and the fact that the exponential function is the generating function for $J_n(z)$, prove the “addition theorem” for Bessel functions:

$$J_n(x+y) = \sum_{k=-\infty}^{\infty} J_k(x)J_{n-k}(y).$$

The discussion in Chap. 15 introduced a general method of solving differential equations by power series—also called the Frobenius method—which gives a solution that converges within a circle of convergence. In general, this circle of convergence may be small; however, the function represented by the power series can be analytically continued using methods presented in Chap. 12.

This chapter, which is a bridge between differential equations and operators on Hilbert spaces (to be developed in the next part), introduces another method of solving DEs, which uses **integral transforms** and incorporates the analytic continuation automatically. The integral transform of a function v is another function u given by

$$u(z) = \int_C K(z, t)v(t) dt, \quad (16.1)$$

where C is a convenient contour, and $K(z, t)$, called the **kernel** of the integral transform, is an appropriate function of two complex variables.

kernel of integral transforms

Example 16.0.1 Let us consider some examples of integral transforms.

examples of integral transforms

- (a) The **Fourier transform** is familiar from the discussion of Chap. 9. The kernel is

$$K(x, y) = e^{ixy}.$$

- (b) The **Laplace transform** is used frequently in electrical engineering. Its kernel is

$$K(x, y) = e^{-xy}.$$

- (c) The **Euler transform** has the kernel

$$K(x, y) = (x - y)^y.$$

- (d) The **Mellin transform** has the kernel

$$K(x, y) = G(x^y),$$

where G is an arbitrary function. Most of the time $K(x, y)$ is taken to be simply x^y .

(e) The **Hankel transform** has the kernel

$$K(x, y) = yJ_n(xy),$$

where J_n is the n th-order Bessel function.

(f) A transform that is useful in connection with the Bessel equation has the kernel

$$K(x, y) = \left(\frac{x}{2}\right)^{\nu} e^{y-x^2/4y}.$$

Strategy for solving DEs using integral transforms

The idea behind using integral transform is to write the solution $u(z)$ of a DE in z in terms of an integral such as Eq. (16.1) and choose v and the kernel in such a way as to render the DE more manageable. Let \mathbf{L}_z be a differential operator (DO) in the variable z . We want to determine $u(z)$ such that $\mathbf{L}_z[u] = 0$, or equivalently, such that $\int_C \mathbf{L}_z[K(z, t)]v(t) dt = 0$. Suppose that we can find \mathbf{M}_t , a DO in the variable t , such that $\mathbf{L}_z[K(z, t)] = \mathbf{M}_t[K(z, t)]$. Then the DE becomes $\int_C (\mathbf{M}_t[K(z, t)])v(t) dt = 0$. If C has a and b as initial and final points (a and b may be equal), then the Lagrange identity [see Eq. (14.23)] yields

$$0 = \mathbf{L}_z[u] = \int_a^b K(z, t)\mathbf{M}_t^\dagger[v(t)] dt + Q[K, v]|_a^b,$$

where $Q[K, v]$ is the “surface term”. If $v(t)$ and the contour C (or a and b) are chosen in such a way that

$$Q[K, v]|_a^b = 0 \quad \text{and} \quad \mathbf{M}_t^\dagger[v(t)] = 0, \tag{16.2}$$

the problem is solved. The trick is to find an \mathbf{M}_t such that Eq. (16.2) is easier to solve than the original equation, $\mathbf{L}_z[u] = 0$. This in turn demands a clever choice of the kernel, $K(z, t)$. This chapter discusses how to solve some common differential equations of mathematical physics using the general idea presented above.

16.1 Integral Representation of the Hypergeometric Function

Recall that for the hypergeometric function, the differential operator is

$$\mathbf{L}_z = z(1-z)\frac{d^2}{dz^2} + [\gamma - (\alpha + \beta + 1)z]\frac{d}{dz} - \alpha\beta.$$

Euler kernel For such operators—whose coefficient functions are polynomials—the proper choice for $K(z, t)$ is the **Euler kernel**, $(z - t)^s$. Applying \mathbf{L}_z to this kernel and rearranging terms, we obtain

$$\begin{aligned} \mathbf{L}_z[K(z, t)] = & \{z^2[-s(s-1) - s(\alpha + \beta + 1) - \alpha\beta] + z[s(s-1) + s\gamma \\ & + st(\alpha + \beta + 1) + 2\alpha\beta t] - \gamma st - \alpha\beta t^2\}(z - t)^{s-2}. \end{aligned} \tag{16.3}$$

Note that except for a multiplicative constant, $K(z, t)$ is symmetric in z and t . This suggests that the general form of \mathbf{M}_t may be chosen to be the same as that of \mathbf{L}_z except for the interchange of z and t . If we can manipulate the parameters in such a way that \mathbf{M}_t becomes simple, then we have a chance of solving the problem. For instance, if \mathbf{M}_t has the form of \mathbf{L}_z with the constant term absent, then the hypergeometric DE effectively reduces to a FODE (in dv/dt). Let us exploit this possibility.

The general form of the \mathbf{M}_t that we are interested in is

$$\mathbf{M}_t = p_2(t) \frac{d^2}{dt^2} + p_1(t) \frac{d}{dt},$$

i.e., with no p_0 term. By applying \mathbf{M}_t to $K(z, t) = (z - t)^s$ and setting the result equal to the RHS of Eq. (16.3), we obtain

$$\begin{aligned} & s(s-1)p_2 - p_1sz + p_1st \\ &= z^2[-s(s-1) - s(\alpha + \beta + 1) - \alpha\beta] \\ &+ z[s(s-1) + s\gamma + st(\alpha + \beta + 1) + 2\alpha\beta t] - \gamma st - \alpha\beta t^2, \end{aligned}$$

for which the coefficients of equal powers of z on both sides must be equal:

$$\begin{aligned} -s(s-1) - s(\alpha + \beta + 1) - \alpha\beta &= 0 \quad \Rightarrow \quad s = -\alpha \quad \text{or} \quad s = -\beta, \\ -p_1s &= s(s-1) + s\gamma + st(\alpha + \beta + 1) + 2\alpha\beta t, \\ s(s-1)p_2 + p_1st &= -\gamma st - \alpha\beta t^2. \end{aligned}$$

If we choose $s = -\alpha$ ($s = -\beta$ leads to an equivalent representation), the coefficient functions of \mathbf{M}_t will be completely determined. In fact, the second equation gives $p_1(t)$, and the third determines $p_2(t)$. We finally obtain

$$p_1(t) = \alpha + 1 - \gamma + t(\beta - \alpha - 1), \quad p_2(t) = t - t^2,$$

and

$$\mathbf{M}_t = (t - t^2) \frac{d^2}{dt^2} + [\alpha + 1 - \gamma + t(\beta - \alpha - 1)] \frac{d}{dt}, \quad (16.4)$$

which, according to Eq. (14.19), yields the following DE for the adjoint:

$$\mathbf{M}_t^\dagger[v] = \frac{d^2}{dt^2}[(t - t^2)v] - \frac{d}{dt}\{[\alpha - \gamma + 1 + t(\beta - \alpha - 1)]v\} = 0. \quad (16.5)$$

The solution to this equation is $v(t) = Ct^{\alpha-\gamma}(t-1)^{\gamma-\beta-1}$ (see Problem 16.5). We also need the surface term, $Q[K, v]$, in the Lagrange identity (see Problem 16.6 for details):

$$Q[K, v](t) = C\alpha t^{\alpha-\gamma+1}(t-1)^{\gamma-\beta}(z-t)^{-\alpha-1}.$$

Finally, we need a specification of the contour. For different contours we will get different solutions. The contour chosen must, of course, have the property that $Q[K, v]$ vanishes as a result of the integration. There are

two possibilities: Either the contour is closed [$a = b$ in (16.2)] or $a \neq b$ but $Q[K, v]$ takes on the same value at a and at b .

Let us consider the second of these possibilities. Clearly, $Q[K, v](t)$ vanishes at $t = 1$ if $\text{Re}(\gamma) > \text{Re}(\beta)$. Also, as $t \rightarrow \infty$,

$$Q[K, v](t) \rightarrow (-1)^{-\alpha-1} C \alpha t^{\alpha-\gamma+1} t^{\gamma-\beta} t^{-\alpha-1} = (-1)^{-\alpha-1} C \alpha t^{-\beta},$$

which vanishes if $\text{Re}(\beta) > 0$. We thus take $a = 1$ and $b = \infty$, and assume that $\text{Re}(\gamma) > \text{Re}(\beta) > 0$. It then follows that

$$u(z) = \int_a^b K(z, t)v(t) dt = C' \int_1^\infty (t-z)^{-\alpha} t^{\alpha-\gamma} (t-1)^{\gamma-\beta-1} dt. \tag{16.6}$$

The constant C' can be determined to be $\Gamma(\gamma)/[\Gamma(\beta)\Gamma(\gamma-\beta)]$ (see Problem 16.7). Therefore,

$$u(z) \equiv F(\alpha, \beta; \gamma; z) = \frac{\Gamma(\gamma)}{\Gamma(\beta)\Gamma(\gamma-\beta)} \int_1^\infty (t-z)^{-\alpha} t^{\alpha-\gamma} (t-1)^{\gamma-\beta-1} dt.$$

Euler formula for the hypergeometric function

It is customary to change the variable of integration from t to $1/t$. The resulting expression is called the **Euler formula** for the hypergeometric function:

$$F(\alpha, \beta; \gamma; z) = \frac{\Gamma(\gamma)}{\Gamma(\beta)\Gamma(\gamma-\beta)} \int_0^1 (1-tz)^{-\alpha} t^{\beta-1} (1-t)^{\gamma-\beta-1} dt. \tag{16.7}$$

Note that the term $(1-tz)^{-\alpha}$ in the integral has two branch points in the z -plane, one at $z = 1/t$ and the other at $z = \infty$. Therefore, we cut the z -plane from $z_1 = 1/t$, a point on the positive real axis, to $z_2 = \infty$. Since $0 \leq t \leq 1$, z_1 is somewhere in the interval $[1, \infty)$. To ensure that the cut is applicable for all values of t , we take $z_1 = 1$ and cut the plane along the positive real axis. It follows that Eq. (16.7) is well behaved as long as

$$0 < \arg(1-z) < 2\pi. \tag{16.8}$$

We could choose a different contour, which, in general, would lead to a different solution. The following example illustrates one such choice.

Example 16.1.1 First note that $Q[K, v]$ vanishes at $t = 0$ and $t = 1$ as long as $\text{Re}(\gamma) > \text{Re}(\beta)$ and $\text{Re}(\alpha) > \text{Re}(\gamma) - 1$. Hence, we can choose the contour to start at $t = 0$ and end at $t = 1$. We then have

$$\begin{aligned} w(z) &= C'' \int_0^1 (z-t)^{-\alpha} t^{\alpha-\gamma} (1-t)^{\gamma-\beta-1} dt \\ &= C'' z^{-\alpha} \int_0^1 \left(1 - \frac{t}{z}\right)^{-\alpha} t^{\alpha-\gamma} (1-t)^{\gamma-\beta-1} dt. \end{aligned} \tag{16.9}$$

To see the relation between $w(z)$ and the hypergeometric function, expand $(1-t/z)^{-\alpha}$ in the integral to get

$$w(z) = C'' z^{-\alpha} \sum_{n=0}^\infty \frac{\Gamma(\alpha+n)}{\Gamma(\alpha)\Gamma(n+1)} \left(\frac{1}{z}\right)^n \int_0^1 t^{\alpha+n-\gamma} (1-t)^{\gamma-\beta-1} dt. \tag{16.10}$$

Now evaluate the integral by changing t to $1/t$ and using Eqs. (12.19) and (12.17). This changes the integral to

$$\int_1^{\infty} t^{-\alpha-n-1+\beta}(t-1)^{\gamma-\beta-1} dt = \frac{\Gamma(\alpha+n+1-\gamma)\Gamma(\gamma-\beta)}{\Gamma(\alpha+n+1-\beta)}.$$

Substituting this in Eq. (16.10), we obtain

$$\begin{aligned} w(z) &= \frac{C''}{\Gamma(\alpha)} \Gamma(\gamma-\beta) z^{-\alpha} \sum_{n=0}^{\infty} \frac{\Gamma(\alpha+n)\Gamma(\alpha+n+1-\gamma)}{\Gamma(\alpha+n+1-\beta)\Gamma(n+1)} \left(\frac{1}{z}\right)^n \\ &= \frac{C''}{\Gamma(\alpha)} \Gamma(\gamma-\beta) z^{-\alpha} \frac{\Gamma(\alpha)\Gamma(\alpha+1-\gamma)}{\Gamma(\alpha+1-\beta)} \\ &\quad \times F(\alpha, \alpha-\gamma+1; \alpha-\beta+1; 1/z), \end{aligned}$$

where we have used the hypergeometric series of Chap. 15. Choosing

$$C'' = \frac{\Gamma(\alpha+1-\beta)}{\Gamma(\gamma-\beta)\Gamma(\alpha+1-\gamma)}$$

yields $w(z) = z^{-\alpha} F(\alpha, \alpha-\gamma+1; \alpha-\beta+1; 1/z)$, which is one of the solutions of the hypergeometric DE [Eq. (15.30)].

16.1.1 Integral Representation of the Confluent Hypergeometric Function

Having obtained the integral representation of the hypergeometric function, we can readily get the integral representation of the confluent hypergeometric function by taking the proper limit. It was shown in Chap. 15 that

$$\Phi(\alpha, \gamma; z) = \lim_{\beta \rightarrow \infty} F(\alpha, \beta; \gamma; z/\beta).$$

This suggests taking the limit of Eq. (16.7). The presence of the gamma functions with β as their arguments complicates things, but on the other hand, the symmetry of the hypergeometric function can be utilized to our advantage. Thus, we may write

$$\begin{aligned} \Phi(\alpha, \gamma; z) &= \lim_{\beta \rightarrow \infty} F\left(\alpha, \beta; \gamma; \frac{z}{\beta}\right) = \lim_{\beta \rightarrow \infty} F\left(\beta, \alpha; \gamma; \frac{z}{\beta}\right) \\ &= \lim_{\beta \rightarrow \infty} \frac{\Gamma(\gamma)}{\Gamma(\alpha)\Gamma(\gamma-\alpha)} \int_0^1 \left(1 - \frac{tz}{\beta}\right)^{-\beta} t^{\alpha-1} (1-t)^{\gamma-\alpha-1} dt \\ &= \frac{\Gamma(\gamma)}{\Gamma(\alpha)\Gamma(\gamma-\alpha)} \int_0^1 e^{zt} t^{\alpha-1} (1-t)^{\gamma-\alpha-1} dt \end{aligned} \quad (16.11)$$

because the limit of the first term in the integral is simply e^{tz} . Note that the condition $\text{Re}(\gamma) > \text{Re}(\alpha) > 0$ must still hold here.

Integral transforms are particularly useful in determining the asymptotic behavior of functions. We shall use them in deriving asymptotic formulas for Bessel functions later on, and Problem 16.10 derives the asymptotic formula for the confluent hypergeometric function.

16.2 Integral Representation of Bessel Functions

Choosing the kernel, the contour, and the function $v(t)$ that lead to an integral representation of a function is an art, and the nineteenth century produced many masters of it. A particularly popular theme in such endeavors was the Bessel equation and Bessel functions. This section considers the integral representations of Bessel functions.

The most effective kernel for the Bessel DE is

$$K(z, t) = \left(\frac{z}{2}\right)^{\nu} \exp\left(t - \frac{z^2}{4t}\right).$$

When the Bessel DO

$$\mathbf{L}_z \equiv \frac{d^2}{dz^2} + \frac{1}{z} \frac{d}{dz} + \left(1 - \frac{z^2}{4t}\right)$$

acts on $K(z, t)$, it yields

$$\mathbf{L}_z K(z, t) = \left(-\frac{\nu+1}{t} + 1 + \frac{z^2}{4t^2}\right) \left(\frac{z}{2}\right)^{\nu} e^{t-z^2/4t} = \left(\frac{d}{dt} - \frac{\nu+1}{t}\right) K(z, t).$$

Thus, $\mathbf{M}_t = d/dt - (\nu+1)/t$, and Eq. (14.19) gives

$$\mathbf{M}_t^{\dagger}[v(t)] = -\frac{dv}{dt} - \frac{\nu+1}{t}v = 0,$$

whose solution, including the arbitrary constant of integration k , is $v(t) = kt^{-\nu-1}$. When we substitute this solution and the kernel in the surface term of the Lagrange identity, Eq. (14.23), we obtain

$$Q[K, v](t) = p_1 K(z, t)v(t) = k \left(\frac{z}{2}\right)^{\nu} t^{-\nu-1} e^{t-z^2/(4t)}.$$

A contour in the t -plane that ensures the vanishing of $Q[K, v]$ for all values of v starts at $t = -\infty$, comes to the origin, orbits it on an arbitrary circle, and finally goes back to $t = -\infty$ (see Fig. 16.1). Such a contour is possible because of the factor e^t in the expression for $Q[K, v]$. We thus can write

$$J_{\nu}(z) = k \left(\frac{z}{2}\right)^{\nu} \int_C t^{-\nu-1} e^{t-z^2/(4t)} dt. \quad (16.12)$$

Note that the integrand has a cut along the negative real axis due to the factor $t^{-\nu-1}$. If ν is an integer, the cut shrinks to a pole at $t = 0$.

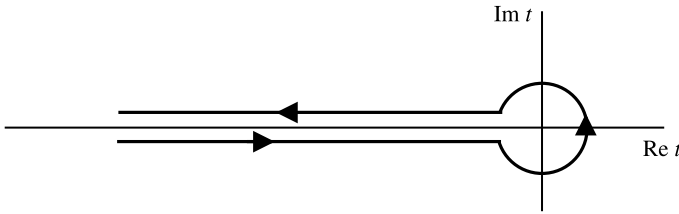

Fig. 16.1 The contour C in the t -plane used in evaluating $J_\nu(z)$

The constant k must be determined in such a way that the above expression for $J_\nu(z)$ agrees with the series representation obtained in Chap. 15. It can be shown (see Problem 16.11) that $k = 1/(2\pi i)$. Thus, we have

$$J_\nu(z) = \frac{1}{2\pi i} \left(\frac{z}{2}\right)^\nu \int_C t^{-\nu-1} e^{t-z^2/(4t)} dt.$$

It is more convenient to take the factor $(z/2)^\nu$ into the integral, introduce a new integration variable $u = 2t/z$, and rewrite the preceding equation as

$$J_\nu(z) = \frac{1}{2\pi i} \int_C u^{-\nu-1} \exp\left[\frac{z}{2}\left(u - \frac{1}{u}\right)\right] du. \tag{16.13}$$

integral representation
of Bessel function

This result is valid as long as $\text{Re}(zu) < 0$ when $u \rightarrow -\infty$ on the negative real axis; that is, $\text{Re}(z)$ must be positive for Eq. (16.13) to work.

An interesting result can be obtained from Eq. (16.13) when ν is an integer. In that case the only singularity will be at the origin, so the contour can be taken to be a circle about the origin. This yields

$$J_n(z) = \frac{1}{2\pi i} \int_C u^{-n-1} \exp\left[\frac{z}{2}\left(u - \frac{1}{u}\right)\right] du,$$

which is the n th coefficient of the Laurent series expansion of $\exp[(z/2)(u - 1/u)]$ about the origin. We thus have this important result:

$$\exp\left[\frac{z}{2}\left(t - \frac{1}{t}\right)\right] = \sum_{n=-\infty}^{\infty} J_n(z)t^n. \tag{16.14}$$

Bessel generating
function

The function $\exp[(z/2)(t - 1/t)]$ is therefore appropriately called the **generating function** for Bessel functions of integer order (see also Problem 15.40). Equation (16.14) can be useful in deriving relations for such Bessel functions as the following example shows.

Example 16.2.1 Let us rewrite the LHS of (16.14) as $e^{zt/2}e^{-z/2t}$, expand the exponentials, and collect terms to obtain

$$\begin{aligned} e^{zt/2}e^{-z/2t} &= \sum_{m=0}^{\infty} \frac{1}{m!} \left(\frac{zt}{2}\right)^m \sum_{n=0}^{\infty} \frac{1}{n!} \left(-\frac{z}{2t}\right)^n \\ &= \sum_{m=0}^{\infty} \sum_{n=0}^{\infty} \frac{(-1)^n}{m!n!} \left(\frac{z}{2}\right)^{m+n} t^{m-n}. \end{aligned}$$

If we let $m - n = k$, change the m summation to k , and note that k goes from $-\infty$ to ∞ , we get

$$\begin{aligned} \exp\left[\frac{z}{2}\left(t - \frac{1}{t}\right)\right] &= \sum_{k=-\infty}^{\infty} \sum_{n=0}^{\infty} \frac{(-1)^n}{(n+k)!n!} \left(\frac{z}{2}\right)^{2n+k} t^k \\ &= \sum_{k=-\infty}^{\infty} \left[\left(\frac{z}{2}\right)^k \sum_{n=0}^{\infty} \frac{(-1)^n}{\Gamma(n+k+1)\Gamma(n+1)} \left(\frac{z}{2}\right)^{2n} \right] t^k. \end{aligned}$$

Comparing this equation with Eq. (16.14) yields the familiar expansion for the Bessel function:

$$J_k(z) = \left(\frac{z}{2}\right)^k \sum_{n=0}^{\infty} \frac{(-1)^n}{\Gamma(n+k+1)\Gamma(n+1)} \left(\frac{z}{2}\right)^{2n}.$$

We can also obtain a recurrence relation for $J_n(z)$. Differentiating both sides of Eq. (16.14) with respect to t yields

$$\frac{z}{2} \left(1 + \frac{1}{t^2}\right) \exp\left[\frac{z}{2}\left(t - \frac{1}{t}\right)\right] = \sum_{n=-\infty}^{\infty} n J_n(z) t^{n-1}. \quad (16.15)$$

Using Eq. (16.14) on the LHS gives

$$\begin{aligned} \sum_{n=-\infty}^{\infty} \left(\frac{z}{2} + \frac{z}{2t^2}\right) J_n(z) t^n &= \frac{z}{2} \sum_{n=-\infty}^{\infty} J_n(z) t^n + \frac{z}{2} \sum_{n=-\infty}^{\infty} J_n(z) t^{n-2} \\ &= \frac{z}{2} \sum_{n=-\infty}^{\infty} J_{n-1}(z) t^{n-1} + \frac{z}{2} \sum_{n=-\infty}^{\infty} J_{n+1}(z) t^{n-1}, \end{aligned} \quad (16.16)$$

where we substituted $n - 1$ for n in the first sum and $n + 1$ for n in the second. Equating the coefficients of equal powers of t on the LHS and the RHS of Eqs. (16.15) and (16.16), we get

$$n J_n(z) = \frac{z}{2} [J_{n-1}(z) + J_{n+1}(z)],$$

which was obtained by a different method in Chap. 15 [see Eq. (15.48)].

We can start with Eq. (16.13) and obtain other integral representations of Bessel functions by making appropriate substitutions. For instance, we can let $u = e^w$ and assume that the circle of the contour C has unit radius. The contour C' in the w -plane is determined as follows. Write $u = r e^{i\theta}$ and $w \equiv x + iy$, so¹ $r e^{i\theta} = e^x e^{iy}$ yielding $r = e^x$ and $e^{i\theta} = e^{iy}$. Along the first part of C , $\theta = -\pi$ and r goes from ∞ to 1. Thus, along the corresponding part of C' , $y = -\pi$ and x goes from ∞ to 0. On the circular part of C , $r = 1$ and θ goes from $-\pi$ to $+\pi$. Thus, along the corresponding part of C' ,

¹Do not confuse x and y with the real and imaginary parts of z .

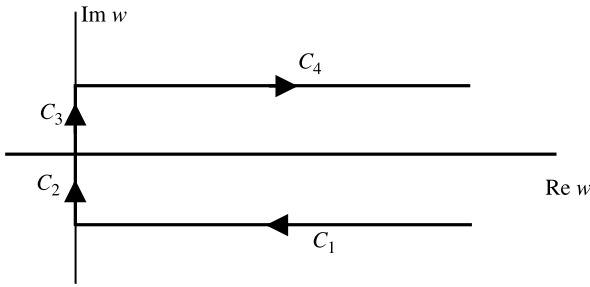

Fig. 16.2 The contour C' in the w -plane used in evaluating $J_\nu(z)$

$x = 0$ and y goes from $-\pi$ to $+\pi$. Finally, on the last part of C' , $y = \pi$ and x goes from 0 to ∞ . Therefore, the contour C' in the w -plane is as shown in Fig. 16.2.

Substituting $u = e^w$ in Eq. (16.13) yields

$$J_\nu(z) = \frac{1}{2\pi i} \int_{C'} e^{z \sinh w - \nu w} dw, \quad \text{Re}(z) > 0, \quad (16.17)$$

which can be transformed into (see Problem 16.12)

$$J_\nu(z) = \frac{1}{\pi} \int_0^\pi \cos(\nu\theta - z \sin \theta) d\theta - \frac{\sin \nu\pi}{\pi} \int_0^\infty e^{-\nu t - z \sinh t} dt. \quad (16.18)$$

For the special case of integer ν , we obtain

$$J_n(z) = \frac{1}{\pi} \int_0^\pi \cos(n\theta - z \sin \theta) d\theta.$$

integral representation
of Bessel functions of
integer order

In particular,

$$J_0(z) = \frac{1}{\pi} \int_0^\pi \cos(z \sin \theta) d\theta.$$

We can use the integral representation for $J_\nu(z)$ to find the integral representation for Bessel functions of other kinds. For instance, to obtain the integral representation for the Neumann function $Y_\nu(z)$, we use Eq. (15.44):

$$\begin{aligned} Y_\nu(z) &= (\cot \nu\pi) J_\nu(z) - \frac{1}{\sin \nu\pi} J_{-\nu}(z) \\ &= \frac{\cot \nu\pi}{\pi} \int_0^\pi \cos(\nu\theta - z \sin \theta) d\theta - \frac{\cos \nu\pi}{\pi} \int_0^\infty e^{-\nu t - z \sinh t} dt \\ &\quad - \frac{1}{\pi \sin \nu\pi} \int_0^\pi \cos(\nu\theta + z \sin \theta) d\theta - \frac{1}{\pi} \int_0^\infty e^{\nu t - z \sinh t} dt \end{aligned}$$

with $\text{Re}(z) > 0$. Substitute $\pi - \theta$ for θ in the third integral on the RHS. Then insert the resulting integrals plus Eq. (16.18) in $H_\nu^{(1)}(z) = J_\nu(z) + iY_\nu(z)$ to

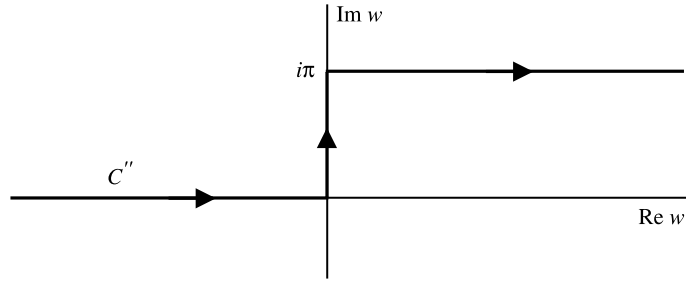

Fig. 16.3 The contour C'' in the w -plane used in evaluating $H_\nu^{(1)}(z)$

obtain

$$H_\nu^{(1)}(z) = \frac{1}{\pi} \int_0^\pi e^{i(z \sin \theta - \nu \theta)} d\theta + \frac{1}{i\pi} \int_0^\infty e^{\nu t - z \sinh t} dt \\ + \frac{e^{-i\nu\pi}}{i\pi} \int_0^\infty e^{-\nu t - z \sinh t} dt, \quad \operatorname{Re}(z) > 0.$$

These integrals can easily be shown to result from integrating along the contour C'' of Fig. 16.3. Thus, we have

$$H_\nu^{(1)}(z) = \frac{1}{i\pi} \int_{C''} e^{z \sinh w - \nu w} dw \quad \operatorname{Re}(z) > 0.$$

By changing i to $-i$, we can show that

$$H_\nu^{(2)}(z) = -\frac{1}{i\pi} \int_{C'''} e^{z \sinh w - \nu w} dw, \quad \operatorname{Re}(z) > 0,$$

where C''' is the mirror image of C'' about the real axis.

16.2.1 Asymptotic Behavior of Bessel Functions

As mentioned before, integral representations are particularly useful for determining the asymptotic behavior of functions. For Bessel functions we can consider two kinds of limits. Assuming that both ν and $z = x$ are real, we can consider $\nu \rightarrow \infty$ or $x \rightarrow \infty$. First, let us consider the behavior of $J_\nu(x)$ of large order. The appropriate method for calculating the asymptotic form is the method of steepest descent discussed in Chap. 12 for which ν takes the place of the large parameter α . We use Eq. (16.17) because its integrand is simpler than that of Eq. (16.13). The form of the integrand in Eq. (16.17) may want to suggest $f(w) = -w$ and $g(w) = e^{x \sinh w}$. However, this choice does not allow setting $f'(w)$ equal to zero. To proceed, therefore, we write the exponent as $\nu(\frac{x}{\nu} \sinh w - w)$, and conveniently introduce $x/\nu \equiv 1/\cosh w_0$, with w_0 a real number, which we take to be positive. Substituting this in the equation above, we can read off

$$f(w) = \frac{\sinh w}{\cosh w_0} - w, \quad g(w) = 1.$$

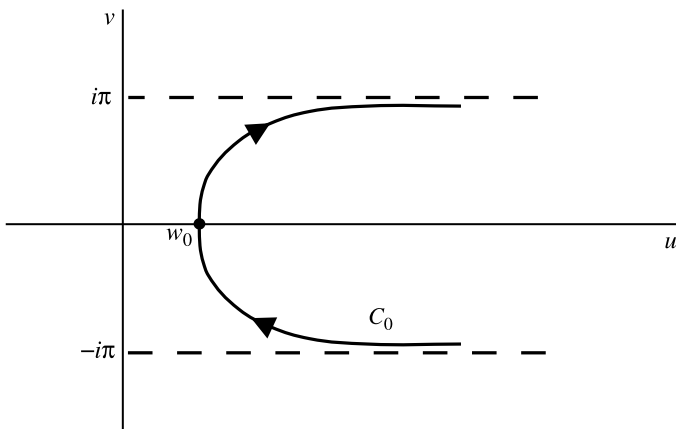

Fig. 16.4 The contour C_0 in the w -plane used in evaluating $J_\nu(z)$ for large values of ν

The saddle point is obtained from $df/dw = 0$ or $\cosh w = \cosh w_0$. Thus, $w = \pm w_0 + 2in\pi$, for $n = 0, 1, 2, \dots$. Since the contour C' lies in the right half-plane, we choose w_0 as the saddle point. The second derivative $f''(w_0)$ is simply $\tanh w_0$, which is real, making $\theta_2 = 0$, and $\theta_1 = \pi/2$ or $3\pi/2$. The convention of Chap. 12 suggests taking $\theta_1 = \pi/2$ (see Fig. 16.4). The rest is a matter of substitution. We are interested in the approximation to w up to the third order in t : $w - w_0 = b_1t + b_2t^2 + b_3t^3$. Using Eqs. (12.31), (12.37), and (12.38), we can easily find the three coefficients:

$$\begin{aligned}
 b_1 &= \frac{\sqrt{2}}{|f''(w_0)|^{1/2}} e^{i\theta_1} = i \frac{\sqrt{2}}{\sqrt{\tanh w_0}}, \\
 b_2 &= \frac{f'''(w_0)}{3|f''(w_0)|^2} e^{4i\theta_1} = \frac{\cosh^2 w_0}{3 \sinh^2 w_0}, \\
 b_3 &= \left\{ \frac{5[f'''(w_0)]^2}{3[f''(w_0)]^2} - \frac{f^{(4)}(w_0)}{f''(w_0)} \right\} \frac{\sqrt{2}e^{3i\theta_1}}{12|f''(w_0)|^{3/2}} \\
 &= -i \frac{\sqrt{2}}{12(\tanh w_0)^{3/2}} \left(\frac{5}{3} \coth^2 w_0 - 1 \right).
 \end{aligned}$$

If we substitute the above in Eq. (12.36), we obtain the following asymptotic formula valid for $\nu \rightarrow \infty$:

$$J_\nu(x) \approx \frac{e^{x(\sinh w_0 - w_0 \cosh w_0)}}{(2\pi x \sinh w_0)^{1/2}} \left[1 + \frac{1}{8x \sinh w_0} \left(1 - \frac{5}{3} \coth^2 w_0 \right) + \dots \right],$$

where ν is related to w_0 via $\nu = x \cosh w_0$.

Let us now consider the asymptotic behavior for large x . It is convenient to consider the Hankel functions $H_\nu^{(1)}(x)$ and $H_\nu^{(2)}(x)$. The contours C'' and C''' involve both the positive and the negative real axis; therefore, it is

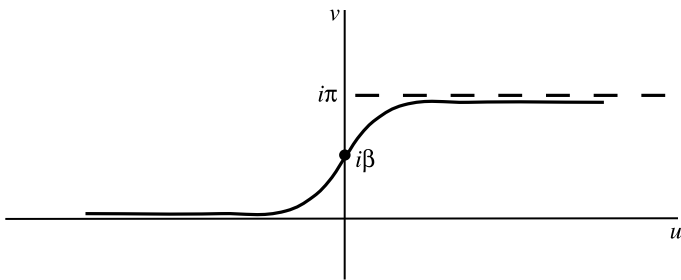

Fig. 16.5 The contour in the w -plane used in evaluating $H_\nu^{(1)}(z)$ in the limit of large values of x

convenient, assuming that $x > \nu$, to write $\nu = x \cos \beta$ so that

$$H_\nu^{(1)}(x) = \frac{1}{i\pi} \int_{C''} e^{x(\sinh w - w \cos \beta)} dw.$$

The saddle points are given by the solutions to $\cosh w = \cos \beta$, which are $w_0 = \pm i\beta$. Choosing $w_0 = +i\beta$, we note that the contour along which

$$\text{Im}(\sinh w - w \cos \beta) = \text{Im}(\sinh w_0 - w_0 \cos \beta)$$

is given by $\cosh u = [\sin \beta + (v - \beta) \cos \beta] / \sin v$. This contour is shown in Fig. 16.5. The rest of the procedure is exactly the same as for $J_\nu(x)$ described above. In fact, to obtain the expansion for $H_\nu^{(1)}(x)$, we simply replace w_0 by $i\beta$. The result is

$$H_\nu^{(1)}(x) \approx \left(\frac{2}{i\pi x \sin \beta} \right)^{1/2} e^{i(x \sin \beta - \nu \beta)} \left[1 + \frac{1}{8ix \sin \beta} \left(1 + \frac{5}{3} \cot^2 \beta \right) + \dots \right].$$

When x is much larger than ν , β will be close to $\pi/2$, and we have

$$H_\nu^{(1)}(x) \approx \sqrt{\frac{2}{\pi x}} e^{i(x - \nu\pi/2 - \pi/4)} \left(1 + \frac{1}{8ix} \right),$$

which, with $1/x \rightarrow 0$, is what we obtained in Example 12.5.2.

The other saddle point, at $-i\beta$, gives the other Hankel function, with the asymptotic limit

$$H_\nu^{(2)}(x) \approx \sqrt{\frac{2}{\pi x}} e^{-i(x - \nu\pi/2 - \pi/4)} \left(1 - \frac{1}{8ix} \right)$$

We can now use the expressions for the asymptotic forms of the two Hankel functions to write the asymptotic forms of $J_\nu(x)$ and $Y_\nu(x)$ for large x :

$$\begin{aligned} J_\nu(x) &= \frac{1}{2} [H_\nu^{(1)}(x) + H_\nu^{(2)}(x)] \\ &\approx \sqrt{\frac{2}{\pi x}} \left[\cos \left(x - \nu \frac{\pi}{2} - \frac{\pi}{4} \right) + \frac{1}{8x} \sin \left(x - \nu \frac{\pi}{2} - \frac{\pi}{4} \right) + \dots \right], \end{aligned}$$

$$\begin{aligned}
 Y_\nu(x) &= \frac{1}{2i} [H_\nu^{(1)}(x) - H_\nu^{(2)}(x)] \\
 &\approx \sqrt{\frac{2}{\pi x}} \left[\sin\left(x - \nu \frac{\pi}{2} - \frac{\pi}{4}\right) - \frac{1}{8x} \cos\left(x - \nu \frac{\pi}{2} - \frac{\pi}{4}\right) + \dots \right].
 \end{aligned}$$

16.3 Problems

16.1 Use the change of variables $k = \ln t$ and $ix = \omega - \alpha$ (where k and x are the common variables used in Fourier transform equations) to show that the Fourier transform changes into a Mellin transform,

$$G(t) = \frac{1}{2\pi i} \int_{-i\infty+\alpha}^{i\infty+\alpha} F(\omega)t^{-\omega}d\omega, \quad \text{where} \quad F(\omega) = \int_0^\infty G(t)t^{\omega-1}dt.$$

16.2 The Laplace transform $L[f]$ of a function $f(t)$ is defined as

$$L[f](s) \equiv \int_0^\infty e^{-st} f(t) dt.$$

Show that the Laplace transform of

- | | | |
|---|--------------------------------------|----------------------------|
| (a) $f(t) = 1$ | is $\frac{1}{s}$, | where $s > 0$. |
| (b) $f(t) = \cosh \omega t$ | is $\frac{s}{s^2 - \omega^2}$, | where $s^2 > \omega^2$. |
| (c) $f(t) = \sinh \omega t$ | is $\frac{\omega}{s^2 - \omega^2}$, | where $s^2 > \omega^2$. |
| (d) $f(t) = \cos \omega t$ | is $\frac{s}{s^2 + \omega^2}$. | |
| (e) $f(t) = \sin \omega t$ | is $\frac{\omega}{s^2 + \omega^2}$. | |
| (f) $f(t) = e^{\omega t}$ for $t > 0$, | is $\frac{1}{s - \omega}$, | where $s > \omega$. |
| (g) $f(t) = t^n$ | is $\frac{\Gamma(n+1)}{s^{n+1}}$, | where $s > 0$, $n > -1$. |

16.3 Evaluate the integral

$$f(t) = \int_0^\infty \frac{\sin \omega t}{\omega} d\omega$$

by finding the Laplace transform and changing the order of integration. Express the result for both $t > 0$ and $t < 0$ in terms of the theta function. (You will need some results from Problem 16.2.)

16.4 Show that the Laplace transform of the derivative of a function is given by $L[F'](s) = sL[F](s) - F(0)$. Similarly, show that for the second derivative the transform is

$$L[F''](s) = s^2L[F](s) - sF(0) - F'(0).$$

Use these results to solve the differential equation $u''(t) + \omega^2u(t) = 0$ subject to the boundary conditions $u(0) = a$, $u'(0) = 0$.

16.5 Solve the DE of Eq. (16.5).

16.6 Calculate the surface term for the hypergeometric DE.

16.7 Determine the constant C' in Eq. (16.6), the solution to the hypergeometric DE. Hint: Expand $(t - z)^{-\alpha}$ inside the integral, use Eqs. (12.19) and (12.17), and compare the ensuing series with the hypergeometric series of Chap. 15.

16.8 Derive the Euler formula [Eq. (16.7)].

16.9 Show that

$$F(\alpha, \beta; \gamma; 1) = \frac{\Gamma(\gamma)\Gamma(\gamma - \alpha - \beta)}{\Gamma(\gamma - \alpha)\Gamma(\gamma - \beta)}. \quad (16.19)$$

Hint: Use Eq. (12.19). Equation (16.19) was obtained by Gauss using only hypergeometric series.

16.10 We determine the asymptotic behavior of $\Phi(\alpha, \gamma; z)$ for $z \rightarrow \infty$ in this problem. Break up the integral in Eq. (16.11) into two parts, one from 0 to $-\infty$ and the other from $-\infty$ to 1. Substitute $-t/z$ for t in the first integral, and $1 - t/z$ for t in the second. Assuming that $z \rightarrow \infty$ along the positive real axis, show that the second integral will dominate, and that

$$\Phi(\alpha, \gamma; z) \rightarrow \frac{\Gamma(\gamma)}{\Gamma(\alpha)} z^{\alpha-\gamma} e^z \quad \text{as } z \rightarrow \infty.$$

16.11 In this problem, we determine the constant k of Eq. (16.12).

- Write the contour integral of Eq. (16.12) for each of the three pieces of the contour. Note that $\arg(t) = -\pi$ as t comes from $-\infty$ and $\arg(t) = \pi$ as t goes to $-\infty$. Obtain a real integral from 0 to ∞ .
- Use the relation $\Gamma(z)\Gamma(1 - z) = \pi/\sin \pi z$, obtained in Chap. 12, to show that

$$\Gamma(-z) = -\frac{\pi}{\Gamma(z+1)\sin \pi z}.$$

- Expand the function $\exp(z^2/4t)$ in the integral of part (a), and show that the contour integral reduces to

$$-2i \sin v\pi \sum_{n=0}^{\infty} \left(\frac{z}{2}\right)^{2n} \frac{\Gamma(-n - v)}{\Gamma(n + 1)}.$$

(d) Use the result of part (c) in part (b), and compare the result with the series expansion of $J_\nu(z)$ in Chap. 15 to arrive finally at $k = 1/(2\pi i)$.

16.12 By integrating along C_1 , C_2 , C_3 , and C_4 of Fig. 16.2, derive Eq. (16.18).

16.13 By substituting $t = \exp(i\theta)$ in Eq. (16.14), show that

$$e^{iz \sin \theta} = J_0(z) + 2 \sum_{n=1}^{\infty} J_{2n}(z) \cos(2n\theta) + 2i \sum_{n=0}^{\infty} J_{2n+1}(z) \sin[(2n+1)\theta].$$

In particular, show that

$$J_0(z) = \frac{1}{2\pi} \int_0^{2\pi} e^{iz \sin \theta} d\theta.$$

16.14 Derive the integral representations of $H_\nu^{(1)}(x)$ and $H_\nu^{(2)}(x)$ given in Sect. 16.2.

Part V
Operators on Hilbert Spaces

The first two parts of the book dealt almost exclusively with algebraic techniques. The third and fourth part were devoted to analytic methods. In this introductory chapter, we shall try to unite these two branches of mathematics to gain insight into the nature of some of the important equations in physics and their solutions. Let us start with a familiar problem.

17.1 From Abstract to Integral and Differential Operators

Let's say we want to solve an abstract operator equation $\mathbf{A}|u\rangle = |v\rangle$ in an N -dimensional vector space \mathcal{V} . To this end, we select a basis $B = \{|a_i\rangle\}_{i=1}^N$, write the equation in matrix form, and solve the resulting system of N linear equations. This produces the components of the solution $|u\rangle$ in B . If components in another basis B' are desired, they can be obtained using the similarity transformation connecting the two bases (see Chap. 5).

There is a standard formal procedure for obtaining the matrix equation. It is convenient to choose an orthonormal basis $B = \{|e_i\rangle\}_{i=1}^N$ for \mathcal{V} and refer all components to this basis. The procedure involves contracting both sides of the equation with $\langle e_i|$ and inserting $\mathbf{1} = \sum_{j=1}^N |e_j\rangle\langle e_j|$ between \mathbf{A} and $|u\rangle$:

$$\sum_{j=1}^N \langle e_i|\mathbf{A}|e_j\rangle\langle e_j|u\rangle = \langle e_i|v\rangle \quad \text{for } i = 1, 2, \dots, N,$$

or

$$\sum_{j=1}^N A_{ij}u_j = v_i \quad \text{for } i = 1, 2, \dots, N, \tag{17.1}$$

where $A_{ij} \equiv \langle e_i|\mathbf{A}|e_j\rangle$, $u_j \equiv \langle e_j|u\rangle$, and $v_i \equiv \langle e_i|v\rangle$. Equation (17.1) is a system of N linear equations in N unknowns $\{u_j\}_{j=1}^N$, which can be solved to obtain the solution(s) of the original equation in B .

A convenient basis is that in which \mathbf{A} is represented by a diagonal matrix $\text{diag}(\lambda_1, \lambda_2, \dots, \lambda_N)$. Then the operator equation takes the simple form $\lambda_i u_i = v_i$, and the solution becomes immediate.

Let us now apply the procedure just described to infinite-dimensional vector spaces, in particular, for the case of a continuous index. We want to find the solutions of $\mathbf{K}|u\rangle = |f\rangle$. Following the procedure used above, we obtain

$$\langle x|\mathbf{K}\left(\underbrace{\int_a^b |y\rangle w(y)\langle y| dy}_{\equiv \mathbf{1}}\right)|u\rangle = \int_a^b \langle x|\mathbf{K}|y\rangle w(y)\langle y|u\rangle dy = \langle x|f\rangle,$$

where we have used the results obtained in Sect. 7.3. Writing this in functional notation, we have

$$\int_a^b K(x, y)w(y)u(y) dy = f(x), \quad (17.2)$$

Integral operators and kernels

which is the continuous analogue of Eq. (17.1). Here (a, b) is the interval on which the functions are defined. We note that the indices have turned into continuous arguments, and the sum has turned into an integral. The operator \mathbf{K} that leads to an equation such as (17.2) is called an **integral operator** (IO), and the “matrix element” $K(x, y)$ is said to be its **kernel**.

local operators

The discussion of the discrete case mentioned the possibility of the operator \mathbf{A} being diagonal in the given basis B . Let us do the same with (17.2); that is, noting that x and y are indices for K , let us assume that $K(x, y) = 0$ for $x \neq y$. Such operators are called **local operators**. For local operators, the contribution to the integral comes only at the point where $x = y$ (hence, their name). If $K(x, y)$ is finite at this point, and the functions $w(y)$ and $u(y)$ are well behaved there, the LHS of (17.2) will vanish, and we will get inconsistencies. To avoid this, we need to have

$$K(x, y) = \begin{cases} 0 & \text{if } x \neq y, \\ \infty & \text{if } x = y. \end{cases}$$

Thus, $K(x, y)$ has the behavior of a delta function. Letting $K(x, y) \equiv L(x)\delta(x - y)/w(x)$ and substituting in Eq. (17.2) yields $L(x)u(x) = f(x)$.

difference between discrete and continuous operators

In the discrete case, λ_i was merely an indexed number; its continuous analogue, $L(x)$, may represent merely a function. However, the fact that x is a continuous variable (index) gives rise to other possibilities for $L(x)$ that do not exist for the discrete case. For instance, $L(x)$ could be a *differential* operator. The derivative, although defined by a limiting process involving neighboring points, is a local operator. Thus, we can speak of the derivative of a function *at a point*. For the discrete case, u_i can only “hop” from i to $i + 1$ and then back to i . Such a difference (as opposed to differential) process is not local; it involves not only i but also $i + 1$. The “point” i does not have an (infinitesimally close) neighbor.

This essential difference between discrete and continuous operators makes the latter far richer in possibilities for applications. In particular, if $L(x)$ is considered a differential operator, the equation $L(x)u(x) = f(x)$ leads directly to the fruitful area of differential equation theory.

17.2 Bounded Operators in Hilbert Spaces

The concept of an operator on a Hilbert space is extremely subtle. Even the elementary characteristics of operators, such as the operation of hermitian conjugation, cannot generally be defined on the whole Hilbert space.

In finite-dimensional vector spaces there is a one-to-one correspondence between operators and matrices. So, in some sense, the study of operators reduces to a study of matrices, which are collections of real or complex numbers. Although we have already noted an analogy between matrices and kernels, a whole new realm of questions arises when A_{ij} is replaced by $K(x, y)$ —questions about the continuity of $K(x, y)$ in both its arguments, about the limit of $K(x, y)$ as x and/or y approach the “end points” of the interval on which \mathbf{K} is defined, about the boundedness and “compactness” of \mathbf{K} , and so on. Such subtleties are not unexpected. After all, when we tried to generalize concepts of finite-dimensional vector spaces to infinite dimensions in Chap. 7, we encountered difficulties. There we were concerned about vectors only; the generalization of operators is even more complicated.

Example 17.2.1 Recall that \mathbb{C}^∞ is the set of sequences $|a\rangle = \{\alpha_i\}_{i=1}^\infty$, or of ∞ -tuples $(\alpha_1, \alpha_2, \dots)$, that satisfy the convergence requirement $\sum_{j=1}^\infty |\alpha_j|^2 < \infty$ (see Example 2.1.2). It is a Hilbert space with inner product defined by $\langle a|b\rangle = \sum_{j=1}^\infty \alpha_j^* \beta_j$. The standard (orthonormal) basis for \mathbb{C}^∞ is $\{|e_i\rangle\}_{i=1}^\infty$, where $|e_i\rangle$ has all components equal to zero except the i th one, which is 1. Then one has $|a\rangle = \sum_{j=1}^\infty \alpha_j |e_j\rangle$.

One can introduce an operator \mathbf{X} , called the **right-shift operator**, by

right-shift operator

$$\mathbf{X}|a\rangle = \mathbf{X}\left(\sum_{j=1}^\infty \alpha_j |e_j\rangle\right) = \sum_{j=1}^\infty \alpha_j |e_{j+1}\rangle.$$

In other words, \mathbf{X} transforms $(\alpha_1, \alpha_2, \dots)$ to $(0, \alpha_1, \alpha_2, \dots)$. It is straightforward to show that \mathbf{X} is indeed a linear operator.

The first step in our study of vector spaces of infinite dimensions was getting a handle on the convergence of infinite sums. This entailed defining a norm for vectors and a distance between them. In addition, we noted that the set of linear transformations $\mathcal{L}(\mathcal{V}, \mathcal{W})$ was a vector space in its own right. Since operators are “vectors” in this space, the study of operators requires constructing a norm in $\mathcal{L}(\mathcal{V}, \mathcal{W})$ when \mathcal{V} and \mathcal{W} are infinite-dimensional.

Definition 17.2.2 Let \mathcal{H}_1 and \mathcal{H}_2 be two Hilbert spaces with norms $\|\cdot\|_1$ and $\|\cdot\|_2$. For any $\mathbf{T} \in \mathcal{L}(\mathcal{H}_1, \mathcal{H}_2)$, the number

$$\max \left\{ \frac{\|\mathbf{T}x\|_2}{\|x\|_1} \mid |x\rangle \neq 0 \right\}$$

operator norm (if it exists) is called¹ the **operator norm** of \mathbf{T} and is denoted by $\|\mathbf{T}\|$. A linear transformation whose norm is finite is called a **bounded linear transformation**. A bounded linear transformation from a Hilbert space to itself is called a **bounded operator**. The collection of all bounded linear transformations, which is a subset of $\mathcal{L}(\mathcal{H}_1, \mathcal{H}_2)$, will be denoted by $\mathcal{B}(\mathcal{H}_1, \mathcal{H}_2)$, and if $\mathcal{H}_1 = \mathcal{H}_2 \equiv \mathcal{H}$, it will be denoted by $\mathcal{B}(\mathcal{H})$.

Note that $\|\cdot\|_1$ and $\|\cdot\|_2$ are the norms induced by the inner product of \mathcal{H}_1 and \mathcal{H}_2 . Also note that by dividing by $\|x\|_1$ we eliminate the possibility of dilating the norm of $\|\mathbf{T}\|$ by choosing a “long” vector. By restricting the length of $|x\rangle$, one can eliminate the necessity for dividing by the length. In fact, the norm can equivalently be defined as

$$\|\mathbf{T}\| = \max\{\|\mathbf{T}x\|_2 \mid \|x\|_1 = 1\} = \max\{\|\mathbf{T}x\|_2 \mid \|x\|_1 \leq 1\}. \quad (17.3)$$

It is straightforward to show that the three definitions are equivalent and they indeed define a norm.

Proposition 17.2.3 *An operator \mathbf{T} is bounded if and only if it maps vectors of finite norm to vectors of finite norm.*

Proof Clearly, if \mathbf{T} is bounded, then $\|\mathbf{T}x\|$ has finite norm. Conversely, if $\|\mathbf{T}x\|_2$ is finite for all $|x\rangle$ (of unit length), $\max\{\|\mathbf{T}x\|_2 \mid \|x\|_1 = 1\}$ is also finite, and \mathbf{T} is bounded. \square

An immediate consequence of the definition is

$$\|\mathbf{T}x\|_2 \leq \|\mathbf{T}\| \|x\|_1 \quad \forall |x\rangle \in \mathcal{H}_1. \quad (17.4)$$

If we choose $|x\rangle = |y\rangle$ instead of $|x\rangle$, it will follow from (17.4) that as $|x\rangle$ approaches $|y\rangle$, $\mathbf{T}|x\rangle$ approaches $\mathbf{T}|y\rangle$. This is the property that characterizes continuity:

bounded operators are continuous **Proposition 17.2.4** *The bounded operator $\mathbf{T} \in \mathcal{B}(\mathcal{H}_1, \mathcal{H}_2)$ is a continuous linear map from \mathcal{H}_1 to \mathcal{H}_2 .*

Another consequence of the definition is that

Box 17.2.5 $\mathcal{B}(\mathcal{H}_1, \mathcal{H}_2)$ is a vector subspace of $\mathcal{L}(\mathcal{H}_1, \mathcal{H}_2)$, and for $\mathcal{H}_1 = \mathcal{H}_2 = \mathcal{H}$, we have $\mathbf{1} \in \mathcal{B}(\mathcal{H})$ and $\|\mathbf{1}\| = 1$.

¹The precise definition uses “supremum” instead of “maximum”. Rather than spending a lot of effort explaining the difference between the two concepts, we use the less precise, but more intuitively familiar, concept of “maximum”.

Example 17.2.6 We have seen that in an inner product space, one can associate a linear operator (linear functional) to every vector. Thus, associated with the vector $|x\rangle$ in a Hilbert space \mathcal{H} is the linear operator $\mathbf{f}_x : \mathcal{H} \rightarrow \mathbb{C}$ defined by $\mathbf{f}_x(|y\rangle) \equiv \langle x|y\rangle$. We want to compare the operator norm of \mathbf{f}_x with the norm of $|x\rangle$. First note that by using the Schwarz inequality, we get

$$\|\mathbf{f}_x\| = \max \left\{ \frac{|\mathbf{f}_x(|y\rangle)|}{\|y\|} \mid |y\rangle \neq 0 \right\} = \max \left\{ \frac{|\langle x|y\rangle|}{\|y\|} \mid |y\rangle \neq 0 \right\} \leq \|x\|.$$

On the other hand, from $\|x\|^2 = \mathbf{f}_x(|x\rangle)$, we obtain

$$\|x\| = \frac{\mathbf{f}_x(|x\rangle)}{\|x\|} \leq \max \left\{ \frac{|\mathbf{f}_x(|y\rangle)|}{\|y\|} \mid |y\rangle \neq 0 \right\} = \|\mathbf{f}_x\|.$$

These two inequalities imply that $\|\mathbf{f}_x\| = \|x\|$.

Example 17.2.7 The derivative operator $\mathbf{D} = d/dx$ is not a bounded operator on the Hilbert space² $\mathcal{L}^2(a, b)$ of square-integrable functions. With a function like $f(x) = \sqrt{x-a}$, one gets

$$\|f\|^2 = \int_a^b (x-a) dx = \frac{1}{2}(b-a)^2 \Rightarrow \|f\| = \frac{b-a}{\sqrt{2}},$$

derivative operator is unbounded

while $df/dx = 1/(2\sqrt{x-a})$ gives $\|\mathbf{D}f\|^2 = \frac{1}{4} \int_a^b dx/(x-a) = \infty$. We conclude that $\|\mathbf{D}\| = \infty$.

Since $\mathcal{L}(\mathcal{H})$ is an algebra as well as a vector space, one may be interested in the relation between the product of operators and their norms. More specifically, one may want to know how $\|\mathbf{ST}\|$ is related to $\|\mathbf{S}\|$ and $\|\mathbf{T}\|$.

norm of a product is less than the product of norms.

Proposition 17.2.8 *If \mathbf{S} and \mathbf{T} are bounded operators, then*

$$\|\mathbf{ST}\| \leq \|\mathbf{S}\| \|\mathbf{T}\|. \tag{17.5}$$

In Particular, $\|\mathbf{T}^n\| \leq \|\mathbf{T}\|^n$.

Proof Use the definition of operator norm for the product \mathbf{ST} :

$$\begin{aligned} \|\mathbf{ST}\| &= \max \left\{ \frac{\|\mathbf{ST}x\|}{\|x\|} \mid |x\rangle \neq 0 \right\} \\ &= \max \left\{ \frac{\|\mathbf{ST}x\|}{\|\mathbf{T}x\|} \frac{\|\mathbf{T}x\|}{\|x\|} \mid |x\rangle \neq 0 \neq \mathbf{T}|x\rangle \right\} \end{aligned}$$

²Here the two Hilbert spaces coincide, so that the derivative operator acts on a single Hilbert space.

$$\leq \max \left\{ \frac{\|\mathbf{S}(\mathbf{T}|x)\|}{\|\mathbf{T}x\|} \mid \mathbf{T}|x\rangle \neq 0 \right\} \underbrace{\max \left\{ \frac{\|\mathbf{T}x\|}{\|x\|} \mid |x\rangle \neq 0 \right\}}_{=\|\mathbf{T}\|}.$$

Now note that the first term on the RHS does not scan all the vectors for maximality: It scans only the vectors in the image of \mathbf{T} . If we include all vectors, we may obtain a larger number. Therefore,

$$\max \left\{ \frac{\|\mathbf{S}(\mathbf{T}|x)\|}{\|\mathbf{T}x\|} \mid \mathbf{T}|x\rangle \neq 0 \right\} \leq \max \left\{ \frac{\|\mathbf{S}x\|}{\|x\|} \mid |x\rangle \neq 0 \right\} = \|\mathbf{S}\|,$$

and the desired inequality is established. \square

We can put Eq. (17.5) to immediate good use.

Proposition 17.2.9 *Let \mathcal{H} be a Hilbert space and $\mathbf{T} \in \mathcal{B}(\mathcal{H})$. If $\|\mathbf{T}\| < 1$, then $\mathbf{1} - \mathbf{T}$ is invertible and $(\mathbf{1} - \mathbf{T})^{-1} = \sum_{n=0}^{\infty} \mathbf{T}^n$.*

Proof First note that the series converges, because

$$\left\| \sum_{n=0}^{\infty} \mathbf{T}^n \right\| \leq \sum_{n=0}^{\infty} \|\mathbf{T}^n\| \leq \sum_{n=0}^{\infty} \|\mathbf{T}\|^n = \frac{1}{1 - \|\mathbf{T}\|}$$

and the sum has a finite norm. Furthermore,

$$\begin{aligned} (\mathbf{1} - \mathbf{T}) \sum_{n=0}^{\infty} \mathbf{T}^n &= (\mathbf{1} - \mathbf{T}) \left(\lim_{k \rightarrow \infty} \sum_{n=0}^k \mathbf{T}^n \right) = \lim_{k \rightarrow \infty} (\mathbf{1} - \mathbf{T}) \sum_{n=0}^k \mathbf{T}^n \\ &= \lim_{k \rightarrow \infty} \left(\sum_{n=0}^k \mathbf{T}^n - \sum_{n=0}^k \mathbf{T}^{n+1} \right) = \lim_{k \rightarrow \infty} (\mathbf{1} - \mathbf{T}^{k+1}) = \mathbf{1}, \end{aligned}$$

because

$$0 \leq \lim_{k \rightarrow \infty} \|\mathbf{T}^{k+1}\| \leq \lim_{k \rightarrow \infty} \|\mathbf{T}\|^{k+1} = 0$$

for $\|\mathbf{T}\| < 1$, and the vanishing of the norm implies the vanishing of the operator itself. One can similarly show that $(\sum_{n=0}^{\infty} \mathbf{T}^n)(\mathbf{1} - \mathbf{T}) = \mathbf{1}$. \square

A corollary of this proposition is that operators that are “close enough” to an invertible operator are invertible (see Problem 17.1). Another corollary, whose proof is left as a straightforward exercise, is the following:

Corollary 17.2.10 *Let $\mathbf{T} \in \mathcal{B}(\mathcal{H})$ and λ a complex number such that $\|\mathbf{T}\| < |\lambda|$. Then $\mathbf{T} - \lambda \mathbf{1}$ is an invertible operator, and*

$$(\mathbf{T} - \lambda \mathbf{1})^{-1} = -\frac{1}{\lambda} \sum_{n=0}^{\infty} \left(\frac{\mathbf{T}}{\lambda} \right)^n.$$

17.2.1 Adjoints of Bounded Operators

Adjoints play an important role in the study of operators. We recall that the adjoint of \mathbf{T} is defined as

$$\langle y|\mathbf{T}|x\rangle^* = \langle x|\mathbf{T}^\dagger|y\rangle \quad \text{or} \quad \langle \mathbf{T}x|y\rangle = \langle x|\mathbf{T}^\dagger y\rangle.$$

In the finite-dimensional case, we could calculate the matrix representation of the adjoint in a particular basis using this definition and generalize to all bases by similarity transformations. That is why we never raised the question of the existence of the adjoint of an operator. In the infinite-dimensional case, one must prove such an existence. We state the following theorem without proof:

Theorem 17.2.11 *Let $\mathbf{T} \in \mathcal{B}(\mathcal{H})$. Then the adjoint of \mathbf{T} , defined by*

$$\langle \mathbf{T}x|y\rangle = \langle x|\mathbf{T}^\dagger y\rangle,$$

exists. Furthermore, $\|\mathbf{T}\| = \|\mathbf{T}^\dagger\|$.

\mathbf{T} and \mathbf{T}^\dagger have equal norms

17.3 Spectra of Linear Operators

One of the most important results of the theory of finite-dimensional vector spaces is the spectral decomposition theorem developed in Chap. 6. The infinite-dimensional analogue of that theorem is far more encompassing and difficult to prove. It is beyond the scope of this book to develop all the machinery needed for a thorough discussion of the infinite-dimensional spectral theory. Instead, we shall present the central results, and occasionally introduce the reader to the peripheral arguments when they seem to have their own merits.

Definition 17.3.1 Let $\mathbf{T} \in \mathcal{L}(\mathcal{H})$. A complex number λ is called a **regular point** of \mathbf{T} if the operator $(\mathbf{T} - \lambda\mathbf{1})^{-1}$ exists and is bounded. The set of all regular points of \mathbf{T} is called the **resolvent set** of \mathbf{T} , and is denoted by $\rho(\mathbf{T})$. The complement of $\rho(\mathbf{T})$ in the complex plane is called the **spectrum** of \mathbf{T} and is denoted by $\sigma(\mathbf{T})$.

regular point, resolvent set, and spectrum of an operator

Note that if \mathbf{T} is bounded, then $\mathbf{T} - \lambda\mathbf{1}$ is automatically bounded.

Corollary 17.2.10 implies that if \mathbf{T} is bounded, then $\rho(\mathbf{T})$ is not empty,³ and that the spectrum of a bounded linear operator on a Hilbert space is a bounded set. In fact, an immediate consequence of the corollary is that $\lambda \leq \|\mathbf{T}\|$ for all $\lambda \in \sigma(\mathbf{T})$.

³One can simply choose a λ whose absolute value is greater than $\|\mathbf{T}\|$.

every eigenvalue of an operator on a vector space of finite dimension is in its spectrum and vice versa

It is instructive to contrast the finite-dimensional case against the implications of the above definition. Recall that because of the dimension theorem, a linear operator on a finite-dimensional vector space \mathcal{V} is invertible if and only if it is either onto or one-to-one. Now, $\lambda \in \sigma(\mathbf{T})$ if and only if $\mathbf{T} - \lambda \mathbf{1}$ is not invertible. For finite dimensions, this implies that⁴ $\ker(\mathbf{T} - \lambda \mathbf{1}) \neq 0$. Thus, in finite dimensions, $\lambda \in \sigma(\mathbf{T})$ if and only if there is a vector $|a\rangle$ in \mathcal{V} such that $(\mathbf{T} - \lambda \mathbf{1})|a\rangle = 0$. This is the combined definition of eigenvalue and eigenvector, and is the definition we will have to use to define eigenvalues in infinite dimensions. It follows that in the finite-dimensional case, $\sigma(\mathbf{T})$ coincides with the set of all eigenvalues of \mathbf{T} . This is not true for infinite dimensions, as the following example shows.

not all points of $\sigma(\mathbf{T})$ are eigenvalues

Example 17.3.2 Consider the right-shift operator acting on \mathbb{C}^∞ . It is easy to see that $\|\mathbf{T}_r a\| = \|a\|$ for all $|a\rangle$. This yields $\|\mathbf{T}_r\| = 1$, so that any λ that belongs to $\sigma(\mathbf{T}_r)$ must be such that $|\lambda| \leq 1$. We now show that the converse is also true, i.e., that if $|\lambda| \leq 1$, then $\lambda \in \sigma(\mathbf{T}_r)$. It is sufficient to show that if $0 < |\lambda| \leq 1$, then $\mathbf{T}_r - \lambda \mathbf{1}$ is not invertible. To establish this, we shall show that $\mathbf{T}_r - \lambda \mathbf{1}$ is not onto.

Suppose that $\mathbf{T}_r - \lambda \mathbf{1}$ is onto. Then there must be a vector $|a\rangle$ such that $(\mathbf{T}_r - \lambda \mathbf{1})|a\rangle = |e_1\rangle$ where $|e_1\rangle$ is the first standard basis vector of \mathbb{C}^∞ . Equating components on both sides yields the recursion relations $\alpha_1 = -1/\lambda$, and $\alpha_{j-1} = \lambda\alpha_j$ for all $j \geq 2$. One can readily solve this recursion relation to obtain $\alpha_j = -1/\lambda^j$ for all j . This is a contradiction, because

$$\sum_{j=1}^{\infty} |\alpha_j|^2 = \sum_{j=1}^{\infty} \frac{1}{|\lambda|^{2j}}$$

will not converge if $0 < |\lambda| \leq 1$, i.e., $|a\rangle \notin \mathbb{C}^\infty$, and therefore $\mathbf{T}_r - \lambda \mathbf{1}$ is not onto.

We conclude that $\sigma(\mathbf{T}_r) = \{\lambda \in \mathbb{C} \mid 0 < |\lambda| \leq 1\}$. If we could generalize the result of the finite-dimensional case to \mathbb{C}^∞ , we would conclude that all complex numbers whose magnitude is at most 1 are eigenvalues of \mathbf{T}_r . Quite to our surprise, the following argument shows that \mathbf{T}_r has no eigenvalues at all!

Suppose that λ is an eigenvalue of \mathbf{T}_r . Let $|a\rangle$ be any eigenvector for λ . Since \mathbf{T}_r preserves the length of a vector, we have

$$\langle a|a\rangle = \langle \mathbf{T}_r a|\mathbf{T}_r a\rangle = \langle \lambda a|\lambda a\rangle = |\lambda|^2 \langle a|a\rangle.$$

It follows that $|\lambda| = 1$. Now write $|a\rangle = \{\alpha_j\}_{j=1}^\infty$ and let α_m be the first nonzero term of this sequence. Then $0 = \langle \mathbf{T}_r a|e_m\rangle = \langle \lambda a|e_m\rangle = \lambda\alpha_m$. The first equality comes about because $\mathbf{T}_r|a\rangle$ has its first nonzero term in the $(m+1)$ st position. Since $\lambda \neq 0$, we must have $\alpha_m = 0$, which contradicts the choice of this number.

⁴Note how critical finite-dimensionality is for this implication. In infinite dimensions, an operator can be one-to-one (thus having a zero kernel) without being onto.

17.4 Compact Sets

This section deals with some technical concepts, and as such will be rather formal. The central concept of this section is compactness. Although we shall be using compactness sparingly in the sequel, the notion has sufficient application in higher analysis and algebra that it warrants an introductory exposure.

Let us start with the familiar case of the real line, and the intuitive notion of “compactness”. Clearly, we do not want to call the entire real line “compact”, because intuitively, it is not. The next candidate seems to be a “finite” interval. So, first consider the *open* interval (a, b) . Can we call it compact? Intuition says “yes”, but the following argument shows that it would not be appropriate to call the open interval compact.

Consider the map $\varphi : \mathbb{R} \rightarrow (a, b)$ given by

$$\varphi(t) = \frac{b-a}{2} \tanh t + \frac{b+a}{2}.$$

The reader may check that this map is continuous and bijective. Thus, we can continuously map all of \mathbb{R} in a one-to-one manner onto (a, b) . This makes (a, b) “look” very much⁵ like \mathbb{R} . How can we modify the interval to make it compact? We do not want to alter its finiteness. So, the obvious thing to do is to add the end points. Thus, the interval $[a, b]$ seems to be a good candidate; and indeed it is.

The next step is to generalize the notion of a closed, finite interval and eventually come up with a definition that can be applied to all spaces. First we need some terminology.

Definition 17.4.1 An **open ball** $B_r(x)$ of radius r and center $|x\rangle$ in a normed vector space \mathcal{V} is the set of all vectors in \mathcal{V} whose distance from $|x\rangle$ is strictly less than r : open ball

$$B_r(x) \equiv \{|y\rangle \in \mathcal{V} \mid \|y - x\| < r\}.$$

We call $B_r(x)$ an **open round neighborhood** of $|x\rangle$. open round neighborhood

This is a generalization of open interval because

$$(a, b) = \left\{ y \in \mathbb{R} \mid \left| y - \frac{a+b}{2} \right| < \frac{b-a}{2} \right\}.$$

Example 17.4.2 A prototype of finite-dimensional normed spaces is \mathbb{R}^n . An open ball of radius r centered at \mathbf{x} is

$$B_r(\mathbf{x}) = \{ \mathbf{y} \in \mathbb{R}^n \mid (y_1 - x_1)^2 + (y_2 - x_2)^2 + \cdots + (y_n - x_n)^2 < r^2 \}.$$

Thus, all points *inside* a circle form an open ball in the xy -plane, and all interior points of a solid sphere form an open ball in space.

⁵In topological jargon one says that (a, b) and \mathbb{R} are **homeomorphic**.

bounded subset **Definition 17.4.3** A **bounded subset** of a normed vector space is a subset that can be enclosed in an open ball of finite radius.

For example, any region drawn on a piece of paper is a bounded subset of \mathbb{R}^2 , and any “visible” part of our environment is a bounded subset of \mathbb{R}^3 because we can always find a big enough circle or sphere to enclose these subsets.

open subset **Definition 17.4.4** A subset \mathcal{O} of a normed vector space \mathcal{V} is called **open** if each of its points (vectors) has an open round neighborhood lying entirely in \mathcal{O} . A **boundary point** of \mathcal{O} is a point (vector) in \mathcal{V} all of whose open round neighborhoods contain points inside and outside \mathcal{O} . A **closed subset** \mathcal{C} of \mathcal{V} is a subset that contains all of its boundary points. The **closure** of a subset S is the union of S and all of its boundary points, and is denoted by \bar{S} .

For example, the boundary of a region drawn on paper consists of all its boundary points. A curve drawn on paper has nothing but boundary points. Every point is also its own boundary. A boundary is always a closed set. In particular, a point is a closed set. In general, an open set cannot contain any boundary points. A frequently used property of a closed set \mathcal{C} is that a convergent sequence of points of \mathcal{C} converges to a point in \mathcal{C} .

dense subset **Definition 17.4.5** A subset W of a normed vector space \mathcal{V} is **dense** in \mathcal{V} if the closure of W is the entire space \mathcal{V} . Equivalently, W is dense if, given any $|u\rangle \in \mathcal{V}$ and any $\epsilon > 0$, there is a $|w\rangle \in W$ such that $\|u - w\| < \epsilon$, i.e., any vector in \mathcal{V} can be approximated, with arbitrary accuracy, by a vector in W .

rational numbers are dense in the real numbers A paradigm of dense spaces is the set of rational numbers in the normed vector space of real numbers. It is a well-known fact that any real number can be approximated by a rational number with arbitrary accuracy: The decimal (or binary) representation of real numbers is precisely such an approximation. An intuitive way of imagining denseness is that the (necessarily) infinite subset is equal to *almost* all of the set, and its members are scattered “densely” everywhere in the set. The embedding of the rational numbers in the set of real numbers, and how they densely populate that set, is a good mental picture of all dense subsets.

A useful property involving the concept of closure and openness has to do with continuous maps between normed vector spaces. Let $f : \mathcal{H}_1 \rightarrow \mathcal{H}_2$ be a continuous map. Let \mathcal{O}_2 be an open set in \mathcal{H}_2 . Let $f^{-1}(\mathcal{O}_2)$ denote the inverse image of \mathcal{O}_2 , i.e., all points of \mathcal{H}_1 that are mapped to \mathcal{O}_2 . Let $|x_1\rangle$ be a vector in $f^{-1}(\mathcal{O}_2)$, $|x_2\rangle = f(|x_1\rangle)$, and let $B_\epsilon(x_2)$ be a ball contained entirely in \mathcal{O}_2 . Then $f^{-1}(B_\epsilon(x_2))$ contains $|x_1\rangle$ and lies entirely in $f^{-1}(\mathcal{O}_2)$. Because of the continuity of f , one can now construct an open ball centered at $|x_1\rangle$ lying entirely in $f^{-1}(B_\epsilon(x_2))$, and by inclusion, in $f^{-1}(\mathcal{O}_2)$. This shows that every point of $f^{-1}(\mathcal{O}_2)$ has a round open neighborhood lying entirely in $f^{-1}(\mathcal{O}_2)$. Thus, $f^{-1}(\mathcal{O}_2)$ is an open subset. One can similarly show the corresponding property for closed subsets. We can summarize this in the following:

Proposition 17.4.6 *Let $f : \mathcal{H}_1 \rightarrow \mathcal{H}_2$ be continuous. Then the inverse image of an open (closed) subset of \mathcal{H}_2 is an open (closed) subset of \mathcal{H}_1 .*

Consider the resolvent set of a bounded operator \mathbf{T} . We claim that this set is open in \mathbb{C} . To see this, note that if $\lambda \in \rho(\mathbf{T})$, then $\mathbf{T} - \lambda\mathbf{1}$ is invertible. On the other hand, Problem 17.1 shows that operators close to an invertible operator are invertible. Thus, if we choose a sufficiently small positive number ϵ and consider all complex numbers μ within a distance ϵ from λ , then all operators of the form $\mathbf{T} - \mu\mathbf{1}$ are invertible, i.e., $\mu \in \rho(\mathbf{T})$. Therefore, any $\lambda \in \rho(\mathbf{T})$ has an open round neighborhood in the complex plane all points of which are in the resolvent. This shows that the resolvent set is open. In particular, it cannot contain any boundary points. However, $\rho(\mathbf{T})$ and $\sigma(\mathbf{T})$ have to be separated by a common boundary.⁶ Since $\rho(\mathbf{T})$ cannot contain any boundary point, $\sigma(\mathbf{T})$ must carry the entire boundary. This shows that $\sigma(\mathbf{T})$ is a closed subset of \mathbb{C} . Recalling that $\sigma(\mathbf{T})$ is also bounded, we have the following result.

$\rho(\mathbf{T})$ is open, and $\sigma(\mathbf{T})$ is closed and bounded in \mathbb{C} .

Proposition 17.4.7 *For any $\mathbf{T} \in \mathcal{B}(\mathcal{H})$ the set $\rho(\mathbf{T})$ is an open subset of \mathbb{C} and $\sigma(\mathbf{T})$ is a closed, bounded subset of \mathbb{C} .*

17.4.1 Compactness and Infinite Sequences

Let us go back to the notion of compactness. It turns out that the feature of the closed interval $[a, b]$ most appropriate for generalization is the behavior of infinite sequences of numbers lying in the interval. More specifically, let $\{\alpha_i\}_{i=1}^\infty$ be a sequence of *infinitely many* real numbers all lying in the interval $[a, b]$. It is intuitively clear that since there is not enough room for these points to stay away from each other, they will have to crowd around a number of points in the interval. For example, the sequence

$$\left\{ (-1)^n \frac{2n+1}{4n} \right\}_{n=1}^\infty = \left\{ -\frac{3}{4}, +\frac{5}{8}, -\frac{7}{12}, +\frac{9}{16}, \dots \right\}$$

in the interval $[-1, +1]$ crowds around the two points $-\frac{1}{2}$ and $+\frac{1}{2}$, i.e., the sequence has two limits, both in the interval. In fact, the points with even n accumulate around $+\frac{1}{2}$ and those with odd n crowd around $-\frac{1}{2}$. It turns out that all closed intervals of \mathbb{R} have this property, namely, all sequences crowd around some (limit) points of the interval. To see that open intervals do not share this property consider the open interval $(0, 1)$. The sequence $\{\frac{1}{2n+1}\}_{n=1}^\infty = \{\frac{1}{3}, \frac{1}{5}, \dots\}$ clearly has the limit point zero, which is not a point of the interval. But we already know that open intervals are not compact.

⁶The spectrum of a bounded operator need not occupy any “area” in the complex plane. It may consist of isolated points or line segments, etc., in which case the spectrum will constitute the entire boundary.

Definition 17.4.8 (Bolzano-Weierstrass Property) A subset \mathcal{K} of a normed vector space is called **compact** if every (infinite) sequence in \mathcal{K} has a convergent subsequence.

The reason for the introduction of a subsequence in the definition is that a sequence may have many points to which it converges. But no matter how many of these points there may exist, one can always obtain a convergent subsequence by choosing from among the points in the sequence. For instance, in the example above, one can choose the subsequence consisting of elements for which n is even. This subsequence converges to the single point $+\frac{1}{2}$.

An important theorem in real analysis characterizes all compact sets in \mathbb{R}^n :⁷

Theorem 17.4.9 (BWHB) *A subset of \mathbb{R}^n is compact if and only if it is closed and bounded.*

We showed earlier that the spectrum of a bounded linear operator is closed and bounded. Identifying \mathbb{C} with \mathbb{R}^2 , the BWHB theorem implies that

Box 17.4.10 *The spectrum of a bounded linear operator is a compact subset of \mathbb{C} .*

An immediate consequence of the BWHB Theorem is that every bounded subset of \mathbb{R}^n has a compact closure. Since \mathbb{R}^n is a prototype of all *finite-dimensional* (normed) vector spaces, the same statement is true for all such vector spaces. What is interesting is that the statement indeed *characterizes* the normed space:

Theorem 17.4.11 *A normed vector space is finite-dimensional if and only if every bounded subset has a compact closure.*

This result can also be applied to *subspaces* of a normed vector space: A subspace \mathcal{W} of a normed vector space \mathcal{V} is finite-dimensional if and only if every bounded subset of \mathcal{W} has a compact closure in \mathcal{W} . A useful version of this property is stated in terms of sequences of points (vectors):

⁷BWHB stands for Bolzano, Weierstrass, Heine, and Borel. Bolzano and Weierstrass proved that any closed and bounded subset of \mathbb{R} has the Bolzano-Weierstrass property. Heine and Borel abstracted the notion of compactness in terms of open sets, and showed that a closed bounded subset of \mathbb{R} is compact. The BWHB theorem as applied to \mathbb{R} is usually called the Heine-Borel theorem (although some authors call it the Bolzano-Weierstrass theorem). Since the Bolzano-Weierstrass property and compactness are equivalent, we have decided to choose BWHB as the name of our theorem.

Theorem 17.4.12 *A subspace \mathcal{W} of a normed vector space \mathcal{V} is finite dimensional if and only if every bounded sequence in \mathcal{W} has a convergent subsequence in \mathcal{W} .*

Historical Notes

Karl Theodor Wilhelm Weierstrass (1815–1897) was both the greatest analyst and the world’s foremost teacher of advanced mathematics of the last third of the nineteenth century. His career was also remarkable in another way—and a consolation to all “late starters”—for he began the solid part of his professional life at the age of almost 40, when most mathematicians are long past their creative years.

His father sent him to the University of Bonn to qualify for the higher ranks of the Prussian civil service by studying law and commerce. But Karl had no interest in these subjects. He infuriated his father by rarely attending lectures, getting poor grades, and instead, becoming a champion beer drinker. He did manage to become a superb fencer, but when he returned home, he had no degree.

In order to earn his living, he made a fresh start by teaching mathematics, physics, botany, German, penmanship, and gymnastics to the children of several small Prussian towns during the day. During the nights, however, he mingled with the intellectuals of the past, particularly the great Norwegian mathematician Abel. His remarkable research on Abelian functions was carried on for years without the knowledge of another living soul; he didn’t discuss it with anyone at all, or submit it for publication in the mathematical journals of the day.

All this changed in 1854 when Weierstrass at last published an account of his research on Abelian functions. This paper caught the attention of an alert professor at the University of Königsberg who persuaded his university to award Weierstrass an honorary doctor’s degree. The Ministry of Education granted Weierstrass a year’s leave of absence with pay to continue his research, and the next year he was appointed to the University of Berlin, where he remained the rest of his life.

Weierstrass’s great creative talents were evenly divided between his thinking and his teaching. The student notes of his lectures, and copies of these notes, and copies of copies, were passed from hand to hand throughout Europe and even America. Like Gauss he was indifferent to fame, but unlike Gauss he endeared himself to generations of students by the generosity with which he encouraged them to develop and publish, and receive credit for, ideas and theorems that he essentially originated himself. Among Weierstrass’s students and followers were Cantor, Schwarz, Hölder, Mittag-Leffler, Sonja Kovalevskaya (Weierstrass’s favorite student), Hilbert, Max Planck, Willard Gibbs, and many others.

In 1885 he published the famous theorem now called the **Weierstrass approximation theorem** (see Theorems 7.2.3 and 9.1.1), which was given a far-reaching generalization, with many applications, by the modern American mathematician M. H. Stone.

The quality that came to be known as “Weierstrassian rigor” was particularly visible in his contributions to the foundations of real analysis. He refused to accept any statement as “intuitively obvious,” but instead demanded ironclad proof based on explicit properties of the real numbers. The careful reasoning required for these proofs was founded on a crucial property of the real numbers now known as the **BWHB theorem**.



Karl Theodor Wilhelm Weierstrass 1815–1897

17.5 Compact Operators

It is straightforward to show that if \mathcal{K} is a compact set in \mathcal{H}_1 and $f : \mathcal{H}_1 \rightarrow \mathcal{H}_2$ is continuous, then $f(\mathcal{K})$ (the image of \mathcal{K}) is compact in \mathcal{H}_2 . Since all bounded operators are continuous, we conclude that *all bounded operators map compact subsets onto compact subsets*. There is a special subset of $\mathcal{B}(\mathcal{H}_1, \mathcal{H}_2)$ that deserves particular attention.

Definition 17.5.1 An operator $\mathbf{K} \in \mathcal{B}(\mathcal{H}_1, \mathcal{H}_2)$ is called a **compact operator** if it maps a *bounded* subset of \mathcal{H}_1 onto a subset of \mathcal{H}_2 with compact closure.

Since we will be dealing with function spaces, and since it is easier to deal with sequences of functions than with subsets of the space of functions, we find it more useful to have a definition of compact operators in terms of sequences rather than subsets. Thus, instead of a bounded subset, we take a subset of it consisting of a (necessarily) bounded sequence. The image of this sequence will be a sequence in a compact set, which, by definition, must have a convergent subsequence. We therefore have the following:

Theorem 17.5.2 An operator $\mathbf{K} \in \mathcal{B}(\mathcal{H}_1, \mathcal{H}_2)$ is compact if and only if for any bounded sequence $\{|x_n\rangle\}$ in \mathcal{H}_1 , the sequence $\{\mathbf{K}|x_n\rangle\}$ has a convergent subsequence in \mathcal{H}_2 .

Example 17.5.3 Consider $\mathcal{B}(\mathcal{H})$, the set of bounded operators on the Hilbert space \mathcal{H} . If \mathbf{K} is a compact operator and \mathbf{T} a bounded operator, then \mathbf{KT} and \mathbf{TK} are compact. This is because $\{\mathbf{T}|x_n\rangle \equiv |y_n\rangle\}$ is a bounded sequence if $\{|x_n\rangle\}$ is, and $\{\mathbf{K}|y_n\rangle = \mathbf{KT}|x_n\rangle\}$ has a convergent subsequence, because \mathbf{K} is compact. For the second part, use the first definition of the compact operator and note that \mathbf{K} maps bounded sets onto compact sets, which \mathbf{T} (being continuous) maps onto a compact set. As a special case of this property we note that the product of two compact operators is compact. Similarly, one can show that any linear combination of compact operators is compact. Thus, any polynomial of a compact operator is compact. In particular,

product of two compact operators is compact

$$(\mathbf{1} - \mathbf{K})^n = \sum_{j=0}^n \frac{n!}{j!(n-j)!} (-\mathbf{K})^j = \mathbf{1} + \sum_{j=1}^n \frac{n!}{j!(n-j)!} (-\mathbf{K})^j \equiv \mathbf{1} - \mathbf{K}_n,$$

where \mathbf{K}_n is a compact operator.

finite rank operators

Definition 17.5.4 An operator $\mathbf{T} \in \mathcal{L}(\mathcal{H}_1, \mathcal{H}_2)$ is called a **finite rank operator** if its range is finite-dimensional.

linear transformations of finite-dimensional vector spaces are compact

The following is clear from Theorem 17.4.12.

Proposition 17.5.5 A finite rank operator is compact. In particular, every linear transformation of a finite-dimensional vector space is compact.

Theorem 17.5.6 If $\{\mathbf{K}_n\} \in \mathcal{L}(\mathcal{H}_1, \mathcal{H}_2)$ are compact and $\mathbf{K} \in \mathcal{L}(\mathcal{H}_1, \mathcal{H}_2)$ is such that $\|\mathbf{K} - \mathbf{K}_n\| \rightarrow 0$, then \mathbf{K} is compact.

Proof See [DeVi 90]. □

Recall that given an orthonormal basis $\{|e_i\rangle\}_{i=1}^\infty$, any operator \mathbf{T} on a Hilbert space \mathcal{H} can be written as $\sum_{i,j=1}^\infty c_{ij}|e_i\rangle\langle e_j|$, where $c_{ij} = \langle e_i|\mathbf{T}|e_j\rangle$. Now let \mathbf{K} be a compact operator and consider the *finite rank* operators

$$\mathbf{K}_n \equiv \sum_{i,j=1}^n c_{ij}|e_i\rangle\langle e_j|, \quad c_{ij} = \langle e_i|\mathbf{K}|e_j\rangle.$$

Clearly, $\|\mathbf{K} - \mathbf{K}_n\| \rightarrow 0$. The hermitian adjoints $\{\mathbf{K}_n^\dagger\}$ are also of finite rank (therefore, compact). Barring some convergence technicality, we see that \mathbf{K}^\dagger , which is the limit of the sequence of these compact operators, is also compact.

Theorem 17.5.7 \mathbf{K} is a compact operator if and only if \mathbf{K}^\dagger is.

\mathbf{K} is compact iff \mathbf{K}^\dagger is

A particular type of operator occurs frequently in integral equation theory. These are called Hilbert-Schmidt operators and defined as follows:

Definition 17.5.8 Let \mathcal{H} be a Hilbert space, and $\{|e_i\rangle\}_{i=1}^\infty$ an orthonormal basis. An operator $\mathbf{T} \in \mathcal{L}(\mathcal{H})$ is called **Hilbert-Schmidt** if

Hilbert-Schmidt operators

$$\text{tr}(\mathbf{T}^\dagger\mathbf{T}) \equiv \sum_{i=1}^\infty \langle e_i|\mathbf{T}^\dagger\mathbf{T}|e_i\rangle = \sum_{i=1}^\infty \langle \mathbf{T}e_i|\mathbf{T}e_i\rangle = \sum_{i=1}^\infty \|\mathbf{T}e_i\|^2 < \infty.$$

Theorem 17.5.9 Hilbert-Schmidt operators are compact.

For a proof, see [Rich 78, pp. 242–246].

Example 17.5.10 It is time to give a concrete example of a compact (Hilbert-Schmidt) operator. For this, we return to Eq. (17.2) with $w(y) = 1$, and assume that $|u\rangle \in \mathcal{L}^2(a, b)$. Suppose further that the function $K(x, y)$ is continuous on the closed rectangle $[a, b] \times [a, b]$ in the xy -plane (or \mathbb{R}^2). Under such conditions, $K(x, y)$ is called a **Hilbert-Schmidt kernel**. We now show that \mathbf{K} is compact. First note that due to the continuity of $K(x, y)$, $\int_a^b \int_a^b |K(x, y)|^2 dx dy < \infty$. Next, we calculate the trace of $\mathbf{K}^\dagger\mathbf{K}$. Let $\{|e_i\rangle\}_{i=1}^\infty$ be any orthonormal basis of $\mathcal{L}^2(a, b)$. Then

Hilbert-Schmidt kernel

$$\begin{aligned} \text{tr} \mathbf{K}^\dagger\mathbf{K} &= \sum_{i=1}^\infty \langle e_i|\mathbf{K}^\dagger\mathbf{K}|e_i\rangle \\ &= \sum_{i=1}^\infty \iiint \langle e_i|x\rangle \langle x|\mathbf{K}^\dagger|y\rangle \langle y|\mathbf{K}|z\rangle \langle z|e_i\rangle dx dy dz \\ &= \iiint \langle y|\mathbf{K}|x\rangle^* \langle y|\mathbf{K}|z\rangle \sum_{i=1}^\infty \langle z|e_i\rangle \langle e_i|x\rangle dx dy dz \end{aligned}$$

$$\begin{aligned}
 &= \iiint \langle y | \mathbf{K} | x \rangle^* \langle y | \mathbf{K} | z \rangle \langle z | \overbrace{\left(\sum_{i=1}^{\infty} |e_i\rangle \langle e_i| \right)}^{=\delta(x-z)} | x \rangle dx dy dz \\
 &= \int_a^b \int_a^b |K(x, y)|^2 dx dy < \infty.
 \end{aligned}$$

Historical Notes

Bernard Bolzano (1781–1848) was a Czech philosopher, mathematician, and theologian who made significant contributions to both mathematics and the theory of knowledge. He entered the Philosophy Faculty of the University of Prague in 1796, studying philosophy and mathematics. He wrote “My special pleasure in mathematics rested therefore particularly on its purely speculative parts, in other words I prized only that part of mathematics which was at the same time philosophy.”

In the autumn of 1800 he began three years of theological study while he was preparing a doctoral thesis on geometry. He received his doctorate in 1804 for a thesis in which he gave his view of mathematics and what constitutes a correct mathematical proof. In the preface he wrote:

I could not be satisfied with a completely strict proof if it were not derived from concepts which the thesis to be proved contained, but rather made use of some fortuitous, alien, intermediate concept, which is always an erroneous transition to another kind.



Bernard Bolzano
1781–1848

Two days after receiving his doctorate Bolzano was ordained a Roman Catholic priest. However, he came to realize that teaching and not ministering defined his true vocation. In the same year, Bolzano was appointed to the chair of philosophy and religion at the University of Prague. Because of his pacifist beliefs and his concern for economic justice, he was suspended from his position in 1819 after pressure from the Austrian government. Bolzano had not given up without a fight but once he was suspended on a charge of heresy he was put under house arrest and forbidden to publish.

Although some of his books had to be published outside Austria because of government censorship, he continued to write and to play an important role in the intellectual life of his country. Bolzano intended to write a series of papers on the foundations of mathematics. He wrote two, the first of which was published. Instead of publishing the second one he decided to “. . . make myself better known to the learned world by publishing some papers which, by their titles, would be more suited to arouse attention.”

Pursuing this strategy he published *Der binomische Lehrsatz . . .* (1816) and *Rein analytischer Beweis . . .* (1817), which contain an attempt to free calculus from the concept of the infinitesimal. He is clear in his intention stating in the preface of the first that the work is “a sample of a new way of developing analysis.” The paper gives a proof of the intermediate value theorem with Bolzano’s new approach and in the work he defined what is now called a Cauchy sequence. The concept appears in Cauchy’s work four years later but it is unlikely that Cauchy had read Bolzano’s work.

After 1817, Bolzano published no further mathematical works for many years. Between the late 1820s and the 1840s, he worked on a major work *Grössenlehre*. This attempt to put the whole of mathematics on a logical foundation was published in parts, while Bolzano hoped that his students would finish and publish the complete work.

His work *Paradoxien des Unendlichen*, a study of paradoxes of the infinite, was published in 1851, three years after his death, by one of his students. The word “set” appears here for the first time. In this work Bolzano gives examples of 1–1 correspondences between the elements of an infinite set and the elements of a proper subset.

Bolzano’s theories of mathematical infinity anticipated Georg Cantor’s theory of infinite sets. It is also remarkable that he gave a function which is nowhere differentiable yet everywhere continuous.

17.5.1 Spectrum of Compact Operators

Our next task is to investigate the spectrum $\sigma(\mathbf{K})$ of a compact operator \mathbf{K} on a Hilbert space \mathcal{H} . We are particularly interested in the set of eigenvalues and eigenvectors of compact operators. Recall that every eigenvalue of an operator on a vector space of finite dimension is in its spectrum, and that every point of the spectrum is an eigenvalue (see p. 518). In general, the second statement is not true. In fact, we saw that the right-shift operator had no eigenvalue at all, yet its spectrum was the entire unit disk of the complex plane.

We first observe that $0 \in \sigma(\mathbf{K})$, because otherwise $0 \in \rho(\mathbf{K})$, which implies that $\mathbf{K} = \mathbf{K} - 0\mathbf{1}$ is invertible with inverse \mathbf{K}^{-1} . The product of two compact operators (in fact, the product of a compact and a bounded operator) is compact (see Example 17.5.3). This yields a contradiction⁸ because the unit operator cannot be compact: It maps a bounded sequence to itself, not to a sequence with a convergent subsequence.

The next theorem, whose proof can be found in [DeVi 90], characterizes the spectrum of a compact operator completely.

Theorem 17.5.11 *Let \mathbf{K} be a compact operator on an infinite-dimensional Hilbert space \mathcal{H} . Then*

1. $0 \in \sigma(\mathbf{K})$.
2. Each nonzero point of $\sigma(\mathbf{K})$ is an eigenvalue of \mathbf{K} whose eigenspace is finite-dimensional.
3. $\sigma(\mathbf{K})$ is either a finite set or it is a sequence that converges to zero.

17.6 Spectral Theorem for Compact Operators

The finite-dimensional spectral decomposition theorem of Chap. 6 was based on the existence of eigenvalues, eigenspaces, and projection operators. Such existence was guaranteed by the existence of an inner product for any finite-dimensional vector space. The task of establishing spectral decomposition for infinite-dimensional vector spaces is complicated not only by the possibility of the absence of an inner product, but also by the questions of completeness, closure, and convergence. One can eliminate the first two hindrances by restricting oneself to a Hilbert space. However, even so, one has to deal with other complications of infinite dimensions.

As an example, consider the relation $\mathcal{V} = \mathcal{W} \oplus \mathcal{W}^\perp$, which is trivially true for any subspace \mathcal{W} in finite dimensions once an orthonormal basis is chosen. Recall that the procedure for establishing this relation is to complement a basis of \mathcal{W} to produce a basis for the whole space. In an infinite-dimensional Hilbert space, we do not know a priori how to complement the

⁸Our conclusion is valid only in infinite dimensions. In finite dimensions, all operators, including $\mathbf{1}$, are compact.

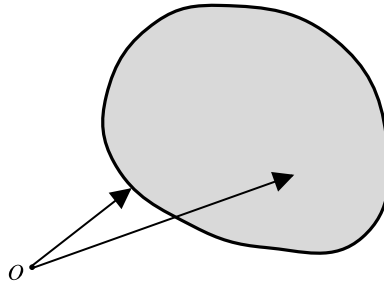

Fig. 17.1 The shaded area represents a convex subset of the vector space. It consists of vectors whose tips lie in the shaded region. It is clear that there is a (unique) vector belonging to the subset whose length is minimum

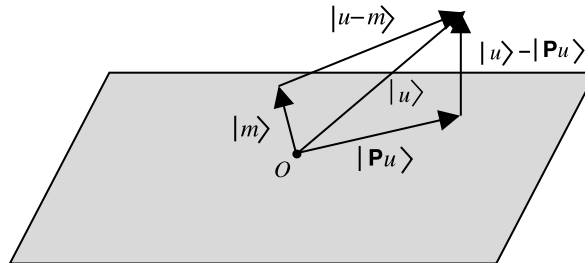

Fig. 17.2 The shaded area represents the subspace \mathcal{M} of the vector space. The convex subset E consists of all vectors connecting points of \mathcal{M} to the tip of $|u\rangle$. It is clear that there is a (unique) vector belonging to E whose length is minimum. The figure shows that this vector is orthogonal to \mathcal{M}

basis of a subspace (which may be infinite-dimensional). Thus, one has to prove the existence of the orthogonal complement of a subspace. Without going into details, we sketch the proof. First a definition:

convex subset **Definition 17.6.1** A **convex subset** E of a vector space is a collection of vectors such that if $|u\rangle$ and $|v\rangle$ are in E , then $|u\rangle - t(|u\rangle - |v\rangle)$ is also in E for all $0 \leq t \leq 1$.

Intuitively, any two points of a convex subset can be connected by a straight line segment lying entirely in the subset.

Let E be a closed convex subset (not a subspace) of a Hilbert space \mathcal{H} . One can show that there exists a unique vector in E with minimal norm (see Fig. 17.1). Now let \mathcal{M} be a subspace of \mathcal{H} . For an arbitrary vector $|u\rangle$ in \mathcal{H} , consider the subset $E = |u\rangle - \mathcal{M}$, i.e., all vectors of the form $|u\rangle - |m\rangle$ with $|m\rangle \in \mathcal{M}$. It is easily shown that E is a closed convex set. Denote the unique vector of minimal norm of $|u\rangle - \mathcal{M}$ by $|u\rangle - |Pu\rangle$ with $|Pu\rangle \in \mathcal{M}$. One can show that $|u\rangle - |Pu\rangle$ is orthogonal to $|m\rangle$ for all $|m\rangle \in \mathcal{M}$, i.e., $(|u\rangle - |Pu\rangle) \in \mathcal{M}^\perp$ (see Fig. 17.2). Obviously, only the zero vector can be simultaneously in \mathcal{M} and \mathcal{M}^\perp . Furthermore, any vector $|u\rangle$ in \mathcal{H} can be written as $|u\rangle = |Pu\rangle + (|u\rangle - |Pu\rangle)$ with $|Pu\rangle \in \mathcal{M}$ and $(|u\rangle - |Pu\rangle) \in \mathcal{M}^\perp$. This shows that $\mathcal{H} = \mathcal{M} \oplus \mathcal{M}^\perp$. In words, a Hilbert space is the direct sum

of any one of its subspaces and the orthogonal complement of that subspace. The vector $|Pu\rangle$ so constructed is the projection of $|u\rangle$ in \mathcal{M} .

A projection operator \mathbf{P} can be defined as a linear operator with the property that $\mathbf{P}^2 = \mathbf{P}$. One can then show the following.

Theorem 17.6.2 *The kernel $\ker \mathbf{P}$ of a projection operator is the orthogonal complement of the range $\mathbf{P}(\mathcal{H})$ of \mathbf{P} in \mathcal{H} iff \mathbf{P} is hermitian.*

17.6.1 Compact Hermitian Operator

We now concentrate on the compact operators, and first look at hermitian compact operators. We need two lemmas:

Lemma 17.6.3 *Let $\mathbf{H} \in \mathcal{B}(\mathcal{H})$ be a bounded hermitian operator on the Hilbert space \mathcal{H} . Then $\|\mathbf{H}\| = \max\{|\langle \mathbf{H}x|x\rangle| \mid \|x\| = 1\}$.*

Proof Let M denote the positive number on the RHS. From the definition of the norm of an operator, we easily obtain $|\langle \mathbf{H}x|x\rangle| \leq \|\mathbf{H}\| \|x\|^2 = \|\mathbf{H}\|$, or $M \leq \|\mathbf{H}\|$. For the reverse inequality, see Problem 17.6. \square

Lemma 17.6.4 *Let $\mathbf{K} \in \mathcal{B}(\mathcal{H})$ be a hermitian compact operator. Then there is an eigenvalue λ of \mathbf{K} such that $|\lambda| = \|\mathbf{K}\|$.*

Proof Let $\{|x_n\rangle\}$ be a sequence of unit vectors such that

$$\|\mathbf{K}\| = \lim |\langle \mathbf{K}x_n|x_n\rangle|.$$

This is always possible, as the following argument shows. Let ϵ be a small positive number. There must exist a unit vector $|x_1\rangle \in \mathcal{H}$ such that

$$\|\mathbf{K}\| - \epsilon = |\langle \mathbf{K}x_1|x_1\rangle|,$$

because otherwise, $\|\mathbf{K}\| - \epsilon$ would be greater than or equal to the norm of the operator (see Lemma 17.6.3). Similarly, there must exist another (different) unit vector $|x_2\rangle \in \mathcal{H}$ such that $\|\mathbf{K}\| - \epsilon/2 = |\langle \mathbf{K}x_2|x_2\rangle|$. Continuing this way, we construct an infinite sequence of unit vectors $\{|x_n\rangle\}$ with the property $\|\mathbf{K}\| - \epsilon/n = |\langle \mathbf{K}x_n|x_n\rangle|$. This construction clearly produces the desired sequence. Note that the argument holds for *any* hermitian bounded operator; compactness is not necessary.

Now define $\lambda_n \equiv \langle \mathbf{K}x_n|x_n\rangle$ and let $\lambda = \lim \lambda_n$, so that $|\lambda| = \|\mathbf{K}\|$. Compactness of \mathbf{K} implies that $\{\mathbf{K}x_n\}$ converges. Let $|y\rangle \in \mathcal{H}$ be the limit of $\{\mathbf{K}x_n\}$. Then $\|y\| = \lim \|\mathbf{K}x_n\| \leq \|\mathbf{K}\| \|x_n\| = \|\mathbf{K}\|$. On the other hand,

$$0 \leq \|\mathbf{K}x_n - \lambda x_n\|^2 = \|\mathbf{K}x_n\|^2 - 2\lambda \langle \mathbf{K}x_n|x_n\rangle + |\lambda|^2.$$

Taking the limit and noting that λ_n and λ are real, we get

$$\begin{aligned} 0 &\leq \lim \|\mathbf{K}x_n\|^2 - 2\lambda \lim \langle \mathbf{K}x_n|x_n\rangle + |\lambda|^2 = \|y\|^2 - 2\lambda^2 + \lambda^2 \\ &\Rightarrow \|y\|^2 \geq \|\mathbf{K}\|^2. \end{aligned}$$

It follows from these two inequalities that $\|y\| = \|\mathbf{K}\|$ and that $\lim |x_n\rangle = |y\rangle/\lambda$. Furthermore,

$$(\mathbf{K} - \lambda \mathbf{1})(|y\rangle/\lambda) = (\mathbf{K} - \lambda \mathbf{1})(\lim |x_n\rangle) = \lim (\mathbf{K} - \lambda \mathbf{1})|x_n\rangle = 0$$

Therefore, λ is an eigenvalue of \mathbf{K} with eigenvector $|y\rangle/\lambda$ and $|\lambda| = \|\mathbf{K}\|$. \square

Arrange all the eigenvalues of Theorem 17.5.11 in the order of decreasing absolute value. Let \mathcal{M}_n denote the (finite-dimensional) eigenspace corresponding to eigenvalue λ_n , and \mathbf{P}_n the projection to \mathcal{M}_n . The eigenspaces are pairwise orthogonal and $\mathbf{P}_n \mathbf{P}_m = 0$ for $m \neq n$. This follows in exact analogy with the finite-dimensional case.

First assume that \mathbf{K} has only finitely many eigenvalues,

$$|\lambda_1| \geq |\lambda_2| \geq \cdots \geq |\lambda_r| > 0.$$

Let

$$\mathcal{M} \equiv \mathcal{M}_1 \oplus \mathcal{M}_2 \oplus \cdots \oplus \mathcal{M}_r \equiv \sum_{j=1}^r \oplus \mathcal{M}_j \equiv \bigoplus_{j=1}^r \mathcal{M}_j$$

and let \mathcal{M}_0 be the orthogonal complement of \mathcal{M} . Since each eigenspace is invariant under \mathbf{K} , so is \mathcal{M} . Therefore, by Theorem 6.1.6—which holds for infinite-dimensional vector spaces as well—and the fact that \mathbf{K} is hermitian, \mathcal{M}_0 is also invariant. Let \mathbf{K}_0 be the restriction of \mathbf{K} to \mathcal{M}_0 . By Lemma 17.6.4, \mathbf{K}_0 has an eigenvalue λ such that $|\lambda| = \|\mathbf{K}_0\|$. If $\lambda \neq 0$, it must be one of the eigenvalues already accounted for, because any eigenvalue of \mathbf{K}_0 is also an eigenvalue of \mathbf{K} . This is impossible, because \mathcal{M}_0 is orthogonal to all the eigenspaces. So, $\lambda = 0$, or $|\lambda| = \|\mathbf{K}_0\| = 0$, or $\mathbf{K}_0 = \mathbf{0}$, i.e., \mathbf{K} acts as the zero operator on \mathcal{M}_0 .

Let \mathbf{P}_0 be the orthogonal projection on \mathcal{M}_0 . Then $\mathcal{H} = \sum_{j=0}^r \oplus \mathcal{M}_j$, and we have $\mathbf{1} = \sum_{j=0}^r \mathbf{P}_j$, and for an arbitrary $|x\rangle \in \mathcal{H}$, we have

$$\mathbf{K}|x\rangle = \mathbf{K} \left(\sum_{j=0}^r \mathbf{P}_j |x\rangle \right) = \sum_{j=0}^r \mathbf{K}(\mathbf{P}_j |x\rangle) = \sum_{j=1}^r \lambda_j (\mathbf{P}_j |x\rangle).$$

It follows that $\mathbf{K} = \sum_{j=1}^r \lambda_j \mathbf{P}_j$. Notice that the range of \mathbf{K} is $\sum_{j=1}^r \oplus \mathcal{M}_j$, which is finite-dimensional. Thus, \mathbf{K} has finite rank. Barring some technical details, which we shall not reproduce here, the case of a compact hermitian operator with infinitely many eigenvalues goes through in the same way (see [DeVi 90, pp. 179–180]):

spectral theorem for
compact hermitian
operators

Theorem 17.6.5 (Spectral Theorem: Compact Hermitian Operators) *Let \mathbf{K} be a compact hermitian operator on a Hilbert space \mathcal{H} . Let $\{\lambda_j\}_{j=1}^N$ be the distinct nonzero eigenvalues of \mathbf{K} arranged in decreasing order of absolute values. For each j let \mathcal{M}_j be the eigenspace of \mathbf{K} corresponding to eigenvalue λ_j and \mathbf{P}_j its projection operator with the property $\mathbf{P}_i \mathbf{P}_j = 0$ for $i \neq j$. Then:*

1. If $N < \infty$, then \mathbf{K} is an operator of finite rank, $\mathbf{K} = \sum_{j=1}^N \lambda_j \mathbf{P}_j$, and $\mathcal{H} = \mathcal{M}_0 \oplus \mathcal{M}_1 \oplus \cdots \oplus \mathcal{M}_N$, or $\mathbf{1} = \sum_{j=0}^N \mathbf{P}_j$, where \mathcal{M}_0 is infinite-dimensional.
2. If $N = \infty$, then $\lambda_j \rightarrow 0$ as $j \rightarrow \infty$, $\mathbf{K} = \sum_{j=1}^{\infty} \lambda_j \mathbf{P}_j$, and $\mathcal{H} = \mathcal{M}_0 \oplus \sum_{j=1}^{\infty} \mathcal{M}_j$, or $\mathbf{1} = \sum_{j=0}^{\infty} \mathbf{P}_j$, where \mathcal{M}_0 could be finite- or infinite-dimensional. Furthermore,

$$\left\| \mathbf{K} - \sum_{j=1}^m \lambda_j \mathbf{P}_j \right\| = |\lambda_{m+1}| \quad \forall m,$$

which shows that the infinite series above converges for an operator norm.

The eigenspaces of a compact hermitian operator are orthogonal and, by (2) of Theorem 17.6.5, span the entire space. By the Gram–Schmidt process, one can select an orthonormal basis for each eigenspace. We therefore have the following corollary.

Corollary 17.6.6 *If \mathbf{K} is a compact hermitian operator on a Hilbert space \mathcal{H} , then the eigenvectors of \mathbf{K} constitute an orthonormal basis for \mathcal{H} .*

Theorem 17.6.7 *Let \mathbf{K} be a compact hermitian operator on a Hilbert space \mathcal{H} and let $\mathbf{K} = \sum_{j=1}^N \lambda_j \mathbf{P}_j$, where N could be infinite. A bounded linear operator on \mathcal{H} commutes with \mathbf{K} if and only if it commutes with every \mathbf{P}_j .*

Proof The “if” part is straightforward. So assume that the bounded operator \mathbf{T} commutes with \mathbf{K} . For $|x\rangle \in \mathcal{M}_j$, we have $(\mathbf{K} - \lambda_j)\mathbf{T}|x\rangle = \mathbf{T}(\mathbf{K} - \lambda_j)|x\rangle = 0$. Similarly, $(\mathbf{K} - \lambda_j)\mathbf{T}^\dagger|x\rangle = \mathbf{T}^\dagger(\mathbf{K} - \lambda_j)|x\rangle = 0$, because $0 = [\mathbf{T}, \mathbf{K}]^\dagger = [\mathbf{T}^\dagger, \mathbf{K}]$. These equations show that both \mathbf{T} and \mathbf{T}^\dagger leave \mathcal{M}_j invariant. This means that \mathcal{M}_j reduces \mathbf{T} , and by Theorem 6.1.8, $\mathbf{T}\mathbf{P}_j = \mathbf{P}_j\mathbf{T}$. \square

17.6.2 Compact Normal Operator

Next we prove the spectral theorem for a normal operator. Recall that any operator \mathbf{T} can be written as $\mathbf{T} = \mathbf{X} + i\mathbf{Y}$ where $\mathbf{X} = \frac{1}{2}(\mathbf{T} + \mathbf{T}^\dagger)$ and $\mathbf{Y} = \frac{1}{2i}(\mathbf{T} - \mathbf{T}^\dagger)$ are hermitian, and since both \mathbf{T} and \mathbf{T}^\dagger are compact, \mathbf{X} and \mathbf{Y} are compact as well. For normal operators, we have the extra condition that $[\mathbf{X}, \mathbf{Y}] = [\mathbf{T}, \mathbf{T}^\dagger] = 0$. Let $\mathbf{X} = \sum_{j=1}^N \lambda_j \mathbf{P}_j$ and $\mathbf{Y} = \sum_{k=1}^N \mu_k \mathbf{Q}_k$ be the spectral decompositions of \mathbf{X} and \mathbf{Y} . Using Theorem 17.6.7, it is straightforward to show that if $[\mathbf{X}, \mathbf{Y}] = 0$ then $[\mathbf{P}_j, \mathbf{Q}_k] = 0$. Now, since $\mathcal{H} = \sum_{j=0}^N \mathcal{M}_j = \sum_{k=0}^N \mathcal{N}_k$, where \mathcal{M}_j are the eigenspaces of \mathbf{X} and \mathcal{N}_k those of \mathbf{Y} , we have, for any $|x\rangle \in \mathcal{H}$,

$$\mathbf{X}|x\rangle = \left(\sum_{j=1}^N \lambda_j \mathbf{P}_j \right) \left(\sum_{k=0}^N \mathbf{Q}_k |x\rangle \right) = \sum_{j=1}^N \sum_{k=0}^N \lambda_j \mathbf{P}_j \mathbf{Q}_k |x\rangle.$$

Similarly,

$$\mathbf{Y}|x\rangle = \mathbf{Y}\left(\sum_{j=0}^N \mathbf{P}_j|x\rangle\right) = \sum_{k=1}^N \sum_{j=0}^N \mu_k \mathbf{Q}_k \mathbf{P}_j|x\rangle.$$

Combining these two relations and noting that $\mathbf{Q}_k \mathbf{P}_j = \mathbf{P}_j \mathbf{Q}_k$ gives

$$\mathbf{T}|x\rangle = (\mathbf{X} + i\mathbf{Y})|x\rangle = \sum_{j=0}^N \sum_{k=0}^N (\lambda_j + i\mu_k) \mathbf{P}_j \mathbf{Q}_k|x\rangle.$$

The projection operators $\mathbf{P}_j \mathbf{Q}_k$ project onto the intersection of \mathcal{M}_j and \mathcal{N}_k . Therefore, $\mathcal{M}_j \cap \mathcal{N}_k$ are the eigenspaces of \mathbf{T} . Only those terms in the sum for which $\mathcal{M}_j \cap \mathcal{N}_k \neq \emptyset$ contribute. As before, we can order the eigenvalues according to their absolute values.

spectral theorem for
compact normal
operators

Theorem 17.6.8 (Spectral Theorem: Compact Normal Operators) *Let \mathbf{T} be a compact normal operator on a Hilbert space \mathcal{H} . Let $\{\lambda_j\}_{j=1}^N$ (where N can be ∞) be the distinct nonzero eigenvalues of \mathbf{T} arranged in decreasing order of absolute values. For each n let \mathcal{M}_n be the eigenspace of \mathbf{T} corresponding to eigenvalue λ_n and \mathbf{P}_n its projection operator with the property $\mathbf{P}_m \mathbf{P}_n = 0$ for $m \neq n$. Then:*

1. *If $N < \infty$, then \mathbf{T} is an operator of finite rank $\mathbf{T} = \sum_{n=1}^N \lambda_n \mathbf{P}_n$, and $\mathcal{H} = \mathcal{M}_0 \oplus \mathcal{M}_1 \oplus \cdots \oplus \mathcal{M}_N$, or $\mathbf{1} = \sum_{j=0}^N \mathbf{P}_j$, where \mathcal{M}_0 is infinite-dimensional.*
2. *If $N = \infty$, then $\lambda_n \rightarrow 0$ as $n \rightarrow \infty$, $\mathbf{T} = \sum_{n=1}^{\infty} \lambda_n \mathbf{P}_n$, and $\mathcal{H} = \mathcal{M}_0 \oplus \sum_{n=1}^{\infty} \mathcal{M}_n$, or $\mathbf{1} = \sum_{j=0}^{\infty} \mathbf{P}_j$, where \mathcal{M}_0 could be finite- or infinite-dimensional.*

As in the case of a compact hermitian operator, by the Gram-Schmidt process, one can select an orthonormal basis for each eigenspace of a normal operator, in which case we have the following:

Corollary 17.6.9 *If \mathbf{T} is a compact normal operator on a Hilbert space \mathcal{H} , then the eigenvectors of \mathbf{T} constitute an orthonormal basis for \mathcal{H} .*

One can use Theorem 17.6.8 to write any function of a normal operator \mathbf{T} as an expansion in terms of the projection operators of \mathbf{T} . First we note that \mathbf{T}^k has λ_n^k as its expansion coefficients. Next, we add various powers of \mathbf{T} in the form of a polynomial and conclude that the expansion coefficients for a polynomial $p(\mathbf{T})$ are $p(\lambda_n)$. Finally, for any function $f(\mathbf{T})$ we have

$$f(\mathbf{T}) = \sum_{n=1}^{\infty} f(\lambda_n) \mathbf{P}_n. \quad (17.6)$$

Historical Notes

Johann (John) von Neumann, (1903–1957), the eldest of three sons of Max von Neumann, a well-to-do Jewish banker, was privately educated until he entered the gymnasium in 1914. His unusual mathematical abilities soon came to the attention of his teachers,

who pointed out to his father that teaching him conventional school mathematics would be a waste of time; he was therefore tutored in mathematics under the guidance of university professors, and by the age of nineteen he was already recognized as a professional mathematician and had published his first paper.

Von Neumann was Privatdozent at Berlin from 1927 to 1929 and at Hamburg in 1929–1930, then went to Princeton University for three years; in 1933 he was invited to join the newly opened Institute for Advanced Study, of which he was the youngest permanent member at that time. At the outbreak of World War II, von Neumann was called upon to participate in various scientific projects related to the war effort: In particular, from 1943 he was a consultant on the construction of the atomic bomb at Los Alamos. After the war he retained his membership on numerous government boards and committees, and in 1954 he became a member of the Atomic Energy Commission. His health began to fail in 1955, and he died of cancer two years later.

It is only in comparison with the greatest mathematical geniuses of history that von Neumann's scope in pure mathematics may appear somewhat restricted; it was far beyond the range of most of his contemporaries, and his extraordinary work in applied mathematics, in which he certainly equals Gauss, Cauchy, or Poincaré, more than compensates for its limitations. Von Neumann's work in pure mathematics was accomplished between 1925 and 1940, when he seemed to be advancing at a breathless speed on all fronts of logic and analysis at once, not to speak of mathematical physics. The dominant theme in von Neumann's work is by far his work on the *spectral theory of operators* in Hilbert spaces. For twenty years he was the undisputed master in this area, which contains what is now considered his most profound and most original creation, the theory of rings of operators. The first papers (1927) in which Hilbert space theory appears are those on the *foundations of quantum mechanics*. These investigations later led von Neumann to a systematic study of unbounded hermitian operators.

Von Neumann's most famous work in theoretical physics is his *axiomatization of quantum mechanics*. When he began work in that field in 1927, the methods used by its founders were hard to formulate in precise mathematical terms: "Operators" or "functions" were handled without much consideration of their domain of definition or their topological properties, and it was blithely assumed that such "operators", when self-adjoint, could always be "diagonalized" (as in the finite dimensional case), at the expense of introducing Dirac delta functions as "eigenvectors". Von Neumann showed that mathematical rigor could be restored by taking as basic axioms the assumptions that the states of a physical system were points of a Hilbert space and that the measurable quantities were Hermitian (generally unbounded) operators densely defined in that space.

After 1927 von Neumann also devoted much effort to more specific problems of quantum mechanics, such as the problem of measurement and the foundation of quantum statistics and quantum thermodynamics, proving in particular an ergodic theorem for quantum systems. All this work was developed and expanded in *Mathematische Grundlagen der Quantenmechanik* (1932), in which he also discussed the much-debated question of "causality" versus "indeterminacy" and concluded that no introduction of "hidden parameters" could keep the basic structure of quantum theory and restore "causality".

Von Neumann's uncommon grasp of applied mathematics, treated as a whole without divorcing theory from experimental realization, was nowhere more apparent than in his work on computers. He became interested in *numerical computations* in connection with the need for quick estimates and approximate results that developed with the technology used for the war effort—particularly the complex problems of hydrodynamics—and the completely new problems presented by the harnessing of nuclear energy, for which no ready-made theoretical solutions were available. Von Neumann's extraordinary ability for rapid mental calculation was legendary. The story is told of a friend who brought him a simple kinematics problem. Two trains, a certain given distance apart, move toward each other at a given speed. A fly, initially on the windshield of one of the trains, flies back and forth between them, again at a known constant speed. When the trains collide, how far has the fly traveled? One way to solve the problem is to add up all the successively smaller distances in each individual flight. (The easy way is to multiply the fly's speed by the time elapsed until the crash.) After a few seconds of thought, von Neumann quickly gave the correct answer.

"That's strange," remarked his friend, "Most people try to sum the infinite series."

"What's strange about that?" von Neumann replied. "That's what I did."



Johann (John) von Neumann 1903–1957

In closing this section, let us remark that the paradigm of compact operators, namely the Hilbert-Schmidt operator, is such because it is defined on the *finite* rectangle $[a, b] \times [a, b]$. If this rectangle grows beyond limit, or equivalently, if the Hilbert space is $\mathcal{L}^2(R_\infty)$, where R_∞ is some infinite region of the real line, then the compactness property breaks down, as the following example illustrates.

Example 17.6.10 Consider the two kernels

$$K_1(x, t) = e^{-|x-t|} \quad \text{and} \quad K_2(x, t) = \sin xt$$

where the first one acts on $\mathcal{L}^2(-\infty, \infty)$ and the second one on $\mathcal{L}^2(0, \infty)$. One can show (see Problem 17.7) that these two kernels have, respectively, the two eigenfunctions

$$e^{i\alpha t}, \quad \alpha \in \mathbb{R}, \quad \text{and} \quad \sqrt{\frac{\pi}{2}} e^{at} + \frac{t}{a^2 + t^2}, \quad a > 0,$$

corresponding to the two eigenvalues

$$\lambda = \frac{2}{1 + \alpha^2}, \quad \alpha \in \mathbb{R}, \quad \text{and} \quad \lambda = \sqrt{\frac{\pi}{2}}.$$

We see that in the first case, all real numbers between 0 and 2 are eigenvalues, rendering this set uncountable. In the second case, there are infinitely (in fact, uncountably) many eigenvectors (one for each a) corresponding to the single eigenvalue $\sqrt{\pi/2}$. Note, however, that in the first case the eigenfunctions and in the second case the kernel have infinite norms.

17.7 Resolvents

The discussion of the preceding section showed that the spectrum of a normal compact operator is countable. Removing the compactness property in general will remove countability, as shown in Example 17.6.10. We have also seen that the right-shift operator, a bounded operator, has uncountably many points in its spectrum. We therefore expect that the sums in Theorem 17.6.8 should be replaced by integrals in the spectral decomposition theorem for (noncompact) bounded operators. We shall not discuss the spectral theorem for general operators. However, one special class of noncompact operators is essential for the treatment of Sturm-Liouville theory (to be studied in Chap. 19). For these operators, the concept of resolvent will be used, which we develop in this section. This concept also makes a connection between the countable (algebraic) and the uncountable (analytic) cases.

resolvent of an operator **Definition 17.7.1** Let \mathbf{T} be an operator and $\lambda \in \rho(\mathbf{T})$. The operator $\mathbf{R}_\lambda(\mathbf{T}) \equiv (\mathbf{T} - \lambda \mathbf{1})^{-1}$ is called the **resolvent of \mathbf{T} at λ** .

Two important properties of the resolvent are useful in analyzing the spectrum of operators. Let us assume that $\lambda, \mu \in \rho(\mathbf{T})$, $\lambda \neq \mu$, and take the difference between their resolvents. Problem 17.8 shows how to obtain the following relation:

$$\mathbf{R}_\lambda(\mathbf{T}) - \mathbf{R}_\mu(\mathbf{T}) = (\lambda - \mu)\mathbf{R}_\lambda(\mathbf{T})\mathbf{R}_\mu(\mathbf{T}). \quad (17.7)$$

To obtain the second property of the resolvent, we formally (and indefinitely) differentiate $\mathbf{R}_\lambda(\mathbf{T})$ with respect to λ and evaluate the result at $\lambda = \mu$:

$$\frac{d}{d\lambda}\mathbf{R}_\lambda(\mathbf{T}) = \frac{d}{d\lambda}[(\mathbf{T} - \lambda\mathbf{1})^{-1}] = (\mathbf{T} - \lambda\mathbf{1})^{-2} = \mathbf{R}_\lambda^2(\mathbf{T}).$$

Differentiating both sides of this equation, we get $2\mathbf{R}_\lambda^3(\mathbf{T})$, and in general,

$$\frac{d^n}{d\lambda^n}\mathbf{R}_\lambda(\mathbf{T}) = n!\mathbf{R}_\lambda^{n+1}(\mathbf{T}) \quad \Rightarrow \quad \left. \frac{d^n}{d\lambda^n}\mathbf{R}_\lambda(\mathbf{T}) \right|_{\lambda=\mu} = n!\mathbf{R}_\mu^{n+1}(\mathbf{T}).$$

Assuming that the Taylor series expansion exists, we may write

$$\mathbf{R}_\lambda(\mathbf{T}) = \sum_{n=0}^{\infty} \frac{(\lambda - \mu)^n}{n!} \frac{d^n}{d\lambda^n}\mathbf{R}_\lambda(\mathbf{T}) \Big|_{\lambda=\mu} = \sum_{n=0}^{\infty} (\lambda - \mu)^n \mathbf{R}_\mu^{n+1}(\mathbf{T}), \quad (17.8)$$

which is the second property of the resolvent.

We now look into the spectral decomposition from an analytical viewpoint. For convenience, we concentrate on the finite-dimensional case and let \mathbf{A} be an arbitrary (not necessarily hermitian) $N \times N$ matrix. Let λ be a complex number that is larger (in absolute value) than any of the eigenvalues of \mathbf{A} . Since all operators on finite-dimensional vector spaces are compact (by Proposition 17.5.5), Lemma 17.6.4 assures us that $|\lambda| > \|\mathbf{T}\|$, and it is then possible to expand $\mathbf{R}_\lambda(\mathbf{T})$ in a *convergent* power series as follows:

$$\mathbf{R}_\lambda(\mathbf{A}) = (\mathbf{A} - \lambda\mathbf{1})^{-1} = -\frac{1}{\lambda} \sum_{n=0}^{\infty} \left(\frac{\mathbf{A}}{\lambda}\right)^n. \quad (17.9)$$

This is the Laurent expansion of $\mathbf{R}_\lambda(\mathbf{A})$. We can immediately read off the residue of $\mathbf{R}_\lambda(\mathbf{A})$ (the coefficient of $1/\lambda$):

$$\text{Res}[\mathbf{R}_\lambda(\mathbf{A})] = -1 \quad \Rightarrow \quad -\frac{1}{2\pi i} \oint_{\Gamma} \mathbf{R}_\lambda(\mathbf{A}) d\lambda = \mathbf{1},$$

where Γ is a circle with its center at the origin and a radius large enough to encompass all the eigenvalues of \mathbf{A} [see Fig. 17.3(a)]. A similar argument shows that

$$-\frac{1}{2\pi i} \oint_{\Gamma} \lambda \mathbf{R}_\lambda(\mathbf{A}) d\lambda = \mathbf{A},$$

and in general,

$$-\frac{1}{2\pi i} \oint_{\Gamma} \lambda^n \mathbf{R}_\lambda(\mathbf{A}) d\lambda = \mathbf{A}^n \quad \text{for } n = 0, 1, \dots$$

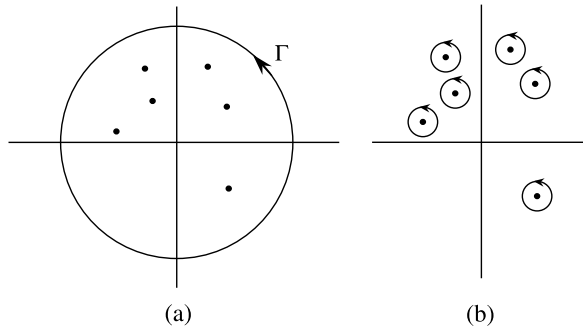

Fig. 17.3 (a) The large circle encompassing all eigenvalues. (b) the deformed contour consisting of small circles orbiting the eigenvalues

Using this and assuming that we can expand the function $f(A)$ in a power series, we get

$$-\frac{1}{2\pi i} \oint_{\Gamma} f(\lambda) R_{\lambda}(A) d\lambda = f(A). \quad (17.10)$$

Writing this equation in the form

$$\frac{1}{2\pi i} \oint_{\Gamma} \frac{f(\lambda)}{\lambda 1 - A} d\lambda = f(A)$$

makes it recognizable as the generalization of the Cauchy integral formula to operator-valued functions.

To use any of the above integral formulas, we must know the analytic behavior of $R_{\lambda}(A)$. From the formula of the inverse of a matrix given in Chap. 5, we have

$$[R_{\lambda}(A)]_{jk} = [(A - \lambda 1)^{-1}]_{jk} = \frac{C_{jk}(\lambda)}{\det(A - \lambda 1)} = \frac{C_{jk}(\lambda)}{p(\lambda)},$$

where $C_{jk}(\lambda)$ is the cofactor of the ij th element of the matrix $A - \lambda 1$ and $p(\lambda)$ is the characteristic polynomial of A . Clearly, $C_{jk}(\lambda)$ is also a polynomial. Thus, $[R_{\lambda}(A)]_{jk}$ is a rational function of λ . It follows that $R_{\lambda}(A)$ has only poles as singularities (see Proposition 11.2.2). The poles are simply the zeros of the denominator, i.e., the eigenvalues of A . We can deform the contour Γ in such a way that it consists of small circles γ_j that encircle the isolated eigenvalues λ_j [see Fig. 17.3(b)]. Then, with $f(A) = 1$, Eq. (17.10) yields

$$1 = -\frac{1}{2\pi i} \sum_{j=1}^r \oint_{\gamma_j} R_{\lambda}(A) d\lambda = \sum_{j=1}^r P_j, \quad P_j \equiv -\frac{1}{2\pi i} \oint_{\gamma_j} R_{\lambda}(A) d\lambda. \quad (17.11)$$

It can be shown (see Example 17.7.2 below) that $\{P_j\}$ is a set of orthogonal projection operators. Thus, Eq. (17.11) is a resolution of identity, as specified in the spectral decomposition theorem in Chap. 6.

Example 17.7.2 We want to show that the P_j are projection operators. First let $i = j$. Then⁹

$$P_j^2 = \left(-\frac{1}{2\pi i}\right)^2 \oint_{\gamma_j} R_\lambda(A) d\lambda \oint_{\gamma_j} R_\mu(A) d\mu.$$

Note that λ need not be equal to μ . In fact, we are free to choose $|\lambda - \lambda_j| > |\mu - \lambda_j|$, i.e., let the circle corresponding to λ integration be outside that of μ integration.¹⁰ We can then rewrite the above double integral as

$$\begin{aligned} P_j^2 &= \left(-\frac{1}{2\pi i}\right)^2 \oint_{\gamma_j^{(\lambda)}} \oint_{\gamma_j^{(\mu)}} R_\lambda(A) R_\mu(A) d\lambda d\mu \\ &= \left(-\frac{1}{2\pi i}\right)^2 \oint_{\gamma_j^{(\lambda)}} \oint_{\gamma_j^{(\mu)}} \left[\frac{R_\lambda(A)}{\lambda - \mu} - \frac{R_\mu(A)}{\lambda - \mu} \right] d\lambda d\mu \\ &= \left(-\frac{1}{2\pi i}\right)^2 \left\{ \oint_{\gamma_j^{(\lambda)}} R_\lambda(A) d\lambda \oint_{\gamma_j^{(\mu)}} \frac{d\mu}{\lambda - \mu} \right. \\ &\quad \left. - \oint_{\gamma_j^{(\mu)}} R_\mu(A) d\mu \oint_{\gamma_j^{(\lambda)}} \frac{d\lambda}{\lambda - \mu} \right\}, \end{aligned}$$

where we used Eq. (17.7) to go to the second line. Now note that

$$\oint_{\gamma_j^{(\mu)}} \frac{d\mu}{\lambda - \mu} = 0 \quad \text{and} \quad \oint_{\gamma_j^{(\lambda)}} \frac{d\lambda}{\lambda - \mu} = 2\pi i$$

because λ lies outside $\gamma_j^{(\mu)}$ and μ lies inside $\gamma_j^{(\lambda)}$. Hence,

$$P_j^2 = \left(-\frac{1}{2\pi i}\right)^2 \left\{ 0 - 2\pi i \oint_{\gamma_j^{(\mu)}} R_\mu(A) d\mu \right\} = -\frac{1}{2\pi i} \oint_{\gamma_j^{(\mu)}} R_\mu(A) d\mu = P_j.$$

The remaining part, namely $P_j P_k = 0$ for $k \neq j$, can be done similarly (see Problem 17.9).

Now we let $f(A) = A$ in Eq. (17.10), deform the contour as above, and write

$$\begin{aligned} A &= -\frac{1}{2\pi i} \sum_{j=1}^r \oint_{\gamma_j} \lambda R_\lambda(A) d\lambda \\ &= -\frac{1}{2\pi i} \sum_{j=1}^r \left[\lambda_j \oint_{\gamma_j} R_\lambda(A) d\lambda + \oint_{\gamma_j} (\lambda - \lambda_j) R_\lambda(A) d\lambda \right] \end{aligned}$$

⁹We have not discussed multiple integrals of complex functions. A rigorous study of such integrals involves the theory of functions of several complex variables—a subject we have to avoid due to lack of space. However, in the simple case at hand, the theory of real multiple integrals is an honest guide.

¹⁰This is possible because the poles are isolated.

$$\equiv \sum_{j=1}^r (\lambda_j P_j + D_j), \quad D_j \equiv \oint_{\gamma_j} (\lambda - \lambda_j) R_\lambda(A) d\lambda. \quad (17.12)$$

It can be shown (see Problem 17.10) that

$$D_j^n = \oint_{\gamma_j} (\lambda - \lambda_j)^n R_\lambda(A) d\lambda.$$

In particular, since $R_\lambda(A)$ has only poles as singularities, there exists a positive integer m such that $D_j^m = 0$. We have not yet made any assumptions about A . If we assume that A is hermitian, for example, then $R_\lambda(A)$ will have simple poles (see Problem 17.11). It follows that $(\lambda - \lambda_j)R_\lambda(A)$ will be analytic at λ_j for all $j = 1, 2, \dots, r$, and $D_j = 0$ in Eq. (17.12). We thus have

$$A = \sum_{j=1}^r \lambda_j P_j,$$

which is the spectral decomposition discussed in Chap. 6. Problem 17.12 shows that the P_j are hermitian.

Example 17.7.3 The most general 2×2 hermitian matrix is of the form

$$A = \begin{pmatrix} a_{11} & a_{12} \\ a_{12}^* & a_{22} \end{pmatrix},$$

where a_{11} and a_{22} are real numbers. Thus,

$$\det(A - \lambda 1) = \lambda^2 - (a_{11} + a_{22})\lambda + a_{11}a_{22} - |a_{12}|^2$$

which has roots

$$\lambda_1 = \frac{1}{2} [a_{11} + a_{22} - \sqrt{(a_{11} - a_{22})^2 + 4|a_{12}|^2}],$$

$$\lambda_2 = \frac{1}{2} [a_{11} + a_{22} + \sqrt{(a_{11} - a_{22})^2 + 4|a_{12}|^2}].$$

The inverse of $A - \lambda 1$ can immediately be written:

$$\begin{aligned} R_\lambda(A) &= (A - \lambda 1)^{-1} = \frac{1}{\det(A - \lambda 1)} \begin{pmatrix} a_{22} - \lambda & -a_{12} \\ -a_{12}^* & a_{11} - \lambda \end{pmatrix} \\ &= \frac{1}{(\lambda - \lambda_1)(\lambda - \lambda_2)} \begin{pmatrix} a_{22} - \lambda & -a_{12} \\ -a_{12}^* & a_{11} - \lambda \end{pmatrix}. \end{aligned}$$

We want to verify that $R_\lambda(A)$ has only simple poles. Two cases arise:

1. If $\lambda_1 \neq \lambda_2$, then it is clear that $R_\lambda(A)$ has simple poles.
2. If $\lambda_1 = \lambda_2$, it *appears* that $R_\lambda(A)$ may have a pole of order 2. However, note that if $\lambda_1 = \lambda_2$, then the square roots in the above equations must vanish. This happens iff $a_{11} = a_{22} \equiv a$ and $a_{12} = 0$. It then follows that

$\lambda_1 = \lambda_2 \equiv a$, and

$$R_\lambda(A) = \frac{1}{(\lambda - a)^2} \begin{pmatrix} a - \lambda & 0 \\ 0 & a - \lambda \end{pmatrix}.$$

This clearly shows that $R_\lambda(A)$ has only simple poles in this case.

If A is not hermitian, $D_j \neq 0$; however, D_j is nevertheless *nilpotent* (see Definition 3.5.1). This property and Eq. (17.12) can be used to show that A can be cast into a *Jordan canonical form* via a similarity transformation. That is, there exists an $N \times N$ matrix S such that

$$SAS^{-1} = J = \begin{pmatrix} J_1 & 0 & 0 & \dots & 0 \\ 0 & J_2 & 0 & \dots & 0 \\ \vdots & \vdots & \vdots & & \vdots \\ 0 & 0 & 0 & \dots & J_m \end{pmatrix}$$

where J_k is a matrix of the form

Jordan canonical form

$$J_k = \begin{pmatrix} \lambda & 1 & 0 & 0 & \dots & 0 & 0 \\ 0 & \lambda & 1 & 0 & \dots & 0 & 0 \\ 0 & 0 & \lambda & 1 & \dots & 0 & 0 \\ \vdots & \vdots & \vdots & \vdots & & \vdots & \vdots \\ 0 & 0 & 0 & 0 & \dots & \lambda & 1 \\ 0 & 0 & 0 & 0 & \dots & 0 & \lambda \end{pmatrix}$$

in which λ is one of the eigenvalues of A . Different J_k may contain the same eigenvalues of A . For a discussion of the Jordan canonical form of a matrix, see [Birk 77], [Denn 67], or [Halm 58].

17.8 Problems

17.1 Suppose that S is a bounded operator, T an invertible operator, and that

$$\|T - S\| < \frac{1}{\|T^{-1}\|}.$$

Show that S is invertible. Hint: Show that $T^{-1}S$ is invertible. Thus, an operator that is “sufficiently close” to an invertible operator is invertible.

17.2 Let \mathcal{V} and \mathcal{W} be finite-dimensional vector spaces. Show that $T \in \mathcal{L}(\mathcal{V}, \mathcal{W})$ is necessarily bounded.

17.3 Let \mathcal{H} be a Hilbert space, and $T \in \mathcal{L}(\mathcal{H})$ an isometry, i.e., a linear operator that does not change the norm of any vector. Show that $\|T\| = 1$.

17.4 Show that

(a) the unit operator is not compact, and that

(b) the inverse of a compact operator cannot be bounded.

Hint: For (b) use the results of Example 17.5.3.

17.5 Let $|u\rangle \in \mathcal{H}$ and let \mathcal{M} be a subspace of \mathcal{H} . Show that the subset $E = |u\rangle - \mathcal{M}$ is convex. Show that E is not necessarily a subspace of \mathcal{H} .

17.6 Show that for any hermitian operator \mathbf{H} , we have

$$4\langle \mathbf{H}x|y\rangle = \langle \mathbf{H}(x+y)|x+y\rangle - \langle \mathbf{H}(x-y)|x-y\rangle \\ + i[\langle \mathbf{H}(x+iy)|x+iy\rangle - \langle \mathbf{H}(x-iy)|x-iy\rangle].$$

Now let $|x\rangle = \lambda|z\rangle$ and $|y\rangle = |\mathbf{H}z\rangle/\lambda$, where $\lambda = (\|\mathbf{H}z\|/\|z\|)^{1/2}$, and show that

$$\|\mathbf{H}z\|^2 = \langle \mathbf{H}x|y\rangle \leq M\|z\|\|\mathbf{H}z\|,$$

where $M = \max\{|\langle \mathbf{H}z|z\rangle|/\|z\|^2\}$. Now conclude that $\|\mathbf{H}\| \leq M$.

17.7 Show that the two kernels $K_1(x, t) = e^{-|x-t|}$ and $K_2(x, t) = \sin xt$, where the first one acts on $\mathcal{L}^2(-\infty, \infty)$ and the second one on $\mathcal{L}^2(0, \infty)$, have the two eigenfunctions

$$e^{i\alpha t}, \quad \alpha \in \mathbb{R}, \quad \text{and} \quad \sqrt{\frac{\pi}{2}}e^{at} + \frac{t}{a^2 + t^2}, \quad a > 0,$$

respectively, corresponding to the two eigenvalues

$$\lambda = \frac{2}{1 + \alpha^2}, \quad \alpha \in \mathbb{R}, \quad \text{and} \quad \lambda = \sqrt{\frac{\pi}{2}}.$$

17.8 Derive Eq. (17.7). Hint: Multiply $\mathbf{R}_\lambda(\mathbf{T})$ by $\mathbf{1} = \mathbf{R}_\mu(\mathbf{T})(\mathbf{T} - \mu\mathbf{1})$ and $\mathbf{R}_\mu(\mathbf{T})$ by $\mathbf{1} = \mathbf{R}_\lambda(\mathbf{T})(\mathbf{T} - \lambda\mathbf{1})$.

17.9 Finish Example 17.7.2 by showing that $\mathbf{P}_j\mathbf{P}_k = 0$ for $k \neq j$.

17.10 Show that $\mathbf{D}_j^n = \oint_{\gamma_j} (\lambda - \lambda_j)^n \mathbf{R}_\lambda(\mathbf{A}) d\lambda$. Hint: Use mathematical induction and the technique used in Example 17.7.2.

17.11 (a) Take the inner product of $|u\rangle = (\mathbf{A} - \lambda\mathbf{1})|v\rangle$ with $|v\rangle$ and show that for a hermitian \mathbf{A} , $\text{Im}\langle v|u\rangle = -(\text{Im}\lambda)\|v\|^2$. Now use the Schwarz inequality to obtain

$$\|v\| \leq \frac{\|u\|}{|\text{Im}\lambda|} \Rightarrow \|\mathbf{R}_\lambda(\mathbf{A})|u\rangle\| \leq \frac{\|u\|}{|\text{Im}\lambda|}.$$

(b) Use this result to show that

$$\|(\lambda - \lambda_j)\mathbf{R}_\lambda(\mathbf{A})|u\rangle\| \leq \left(1 + \left|\frac{\text{Re}(\lambda - \lambda_j)}{\text{Im}(\lambda - \lambda_j)}\right|\right)\|u\| = (1 + |\cot\theta|)\|u\|,$$

where θ is the angle that $\lambda - \lambda_j$ makes with the real axis and λ is chosen to have an imaginary part. From this result conclude that $\mathbf{R}_\lambda(\mathbf{A})$ has a simple pole when \mathbf{A} is hermitian.

17.12 (a) Show that when \mathbf{A} is hermitian, $[\mathbf{R}_\lambda(\mathbf{A})]^\dagger = \mathbf{R}_{\lambda^*}(\mathbf{A})$.

(b) Write $\lambda - \lambda_j = r_j e^{i\theta}$ in the definition of \mathbf{P}_j in Eq. (17.11). Take the hermitian conjugate of both sides and use (a) to show that \mathbf{P}_j is hermitian. Hint: You will have to change the variable of integration a number of times.

The beginning of Chap. 17 showed that to solve a vector-operator equation one transforms it into an equation involving a sum over a discrete index [the matrix equation of Eq. (17.1)], or an equation involving an integral over a continuous index [Eq. (17.2)]. The latter is called an **integral equation**, which we shall investigate here using the machinery of Chap. 17.

18.1 Classification

Integral equations can be divided into two major groups. Those that have a variable limit of integration are called **Volterra equations**; those that have constant limits of integration are called **Fredholm equations**. If the unknown function appears only inside the integral, the integral equation is said to be **of the first kind**. Integral equations having the unknown function outside the integral as well as inside are said to be **of the second kind**. The four kinds of equations can be written as follows.

Volterra and Fredholm equations of first and second kind

$$\int_a^x K(x, t)u(t) dt = v(x), \quad \text{Volterra equation of the 1st kind,}$$

$$\int_a^b K(x, t)u(t) dt = v(x), \quad \text{Fredholm equation of the 1st kind,}$$

$$u(x) = v(x) + \int_a^x K(x, t)u(t) dt, \quad \text{Volterra equation of the 2nd kind,}$$

$$u(x) = v(x) + \int_a^b K(x, t)u(t) dt, \quad \text{Fredholm equation of the 2nd kind.}$$

In all these equations, $K(x, t)$ is called the **kernel** of the integral equation.

kernel of an integral equation

In the theory of integral equations of the second kind, one usually multiplies the integral by a nonzero complex number λ . Thus, the Fredholm equation of the second kind becomes

$$u(x) = v(x) + \lambda \int_a^b K(x, t)u(t) dt, \quad (18.1)$$

and for the Volterra equation of the second kind one obtains

$$u(x) = v(x) + \lambda \int_a^x K(x, t)u(t) dt. \quad (18.2)$$

A λ that satisfies (18.1) or (18.2) with $v(x) = 0$ is called a **characteristic value** of the integral equation. In the abstract operator language both equations are written as

$$|u\rangle = |v\rangle + \lambda \mathbf{K}|u\rangle \Rightarrow (\mathbf{K} - \lambda^{-1} \mathbf{1})|u\rangle = -\lambda^{-1}|v\rangle. \quad (18.3)$$

Thus λ is a characteristic value if and only if λ^{-1} is an eigenvalue of \mathbf{K} . Recall that when the interval of integration (a, b) is finite, $K(x, t)$ is called a *Hilbert-Schmidt* kernel. Example 17.5.10 showed that \mathbf{K} is a compact operator, and by Theorem 17.5.11, the eigenvalues of \mathbf{K} either form a finite set or a sequence that converges to zero.

Theorem 18.1.1 *The characteristic values of a Fredholm equation of the second kind either form a finite set or a sequence of complex numbers increasing beyond limit in absolute value.*

Our main task in this chapter is to study methods of solving integral equations of the second kind. We treat the Volterra equation first because it is easier to solve. Let us introduce the notation

$$K[u](x) \equiv \int_a^x K(x, t)u(t) dt \quad \text{and} \quad K^n[u](x) = K[K^{n-1}[u]](x) \quad (18.4)$$

whereby $K[u]$ denotes a function whose value at x is given by the integral on the RHS of the first equation in (18.4). One can show with little difficulty that the associated operator \mathbf{K} is compact. Let $M = \max\{|K(x, t)| \mid a \leq t \leq x \leq b\}$ and note that

$$|\lambda K[u](x)| = \left| \lambda \int_a^x K(x, t)u(t) dt \right| \leq |\lambda| M \|u\|_\infty (x - a),$$

where $\|u\|_\infty \equiv \max\{|u(x)| \mid x \in (a, b)\}$.

Using mathematical induction, one can show that (see Problem 18.1)

$$|(\lambda \mathbf{K})^n [u](x)| \leq |\lambda|^n |M|^n \|u\|_\infty \frac{(x - a)^n}{n!}. \quad (18.5)$$

Since $b \geq x$, we can replace x with b and still satisfy the inequality. Then the inequality of Eq. (18.5) will hold for all x , and we can write the equation as an operator norm inequality: $\|(\lambda \mathbf{K})^n\| \leq |\lambda|^n |M|^n \|u\|_\infty (b - a)^n / n!$. Therefore,

$$\left\| \sum_{n=0}^{\infty} (\lambda \mathbf{K})^n \right\| \leq \sum_{n=0}^{\infty} \|(\lambda \mathbf{K})^n\| \leq \sum_{n=0}^{\infty} \frac{|\lambda|^n |M|^n (b - a)^n}{n!} = e^{M|\lambda|(b-a)},$$

and the series $\sum_{n=0}^{\infty} (\lambda \mathbf{K})^n$ converges for all λ . In fact, a direct calculation shows that the series converges to the inverse of $\mathbf{1} - \lambda \mathbf{K}$. Thus, the latter is invertible and the spectrum of \mathbf{K} has no nonzero points. We have just shown the following.

Theorem 18.1.2 *The Volterra equation of the second kind has no nonzero characteristic value. In particular, the operator $\mathbf{1} - \lambda \mathbf{K}$ is invertible, the equation always has a unique solution given by the convergent infinite series*

$$u(x) = \sum_{j=0}^{\infty} \lambda^j \int_a^x K^j(x, t) v(t) dt$$

where $K^j(x, t)$ is defined inductively in Eq. (18.4).

Historical Notes

Vito Volterra (1860–1940) was only 11 when he became interested in mathematics while reading Legendre's *Geometry*. At the age of 13 he began to study the three body problem and made some progress.

His family were extremely poor (his father had died when Vito was two years old) but after attending lectures at Florence he was able to proceed to Pisa in 1878. At Pisa he studied under Betti, graduating as a doctor of physics in 1882. His thesis on hydrodynamics included some results of Stokes, discovered later but independently by Volterra.

He became Professor of Mechanics at Pisa in 1883, and upon Betti's death, he occupied the chair of mathematical physics. After spending some time at Turin as the chair of mechanics, he was awarded the chair of mathematical physics at the University of Rome in 1900.

Volterra conceived the idea of a theory of functions that depend on a continuous set of values of another function in 1883. Hadamard was later to introduce the word "functional", which replaced Volterra's original terminology. In 1890 Volterra used his functional calculus to show that the theory of Hamilton and Jacobi for the integration of the differential equations of dynamics could be extended to other problems of mathematical physics.

His most famous work was done on **integral equations**. He began this study in 1884, and in 1896 he published several papers on what is now called the Volterra integral equation. He continued to study functional analysis applications to integral equations producing a large number of papers on composition and permutable functions.

During the First World War Volterra joined the Air Force. He made many journeys to France and England to promote scientific collaboration. After the war he returned to the University of Rome, and his interests moved to mathematical biology. He studied the Verhulst equation and the logistic curve. He also wrote on predator-prey equations.

In 1922 Fascism seized Italy, and Volterra fought against it in the Italian Parliament. However, by 1930 the Parliament was abolished, and when Volterra refused to take an oath of allegiance to the Fascist government in 1931, he was forced to leave the University of Rome. From the following year he lived mostly abroad, mainly in Paris, but also in Spain and other countries.

Differential equations can be transformed into integral equations. For instance, consider the SOLDE

$$\frac{d^2 u}{dx^2} + p_1(x) \frac{du}{dx} + p_0(x) u = r(x), \quad u(a) = c_1, \quad u'(a) = c_2. \quad (18.6)$$

By integrating the DE once, we obtain

$$\frac{du}{dx} = - \int_a^x p_1(t) u'(t) dt - \int_a^x p_0(t) u(t) dt + \int_a^x r(t) dt + c_2.$$

Volterra equation of the second kind has a unique solution and no nonzero characteristic value



Vito Volterra 1860–1940

Integrating the first integral by parts gives

$$u'(x) = -p_1(x)u(x) + \underbrace{\int_a^x [p_1'(t) - p_0(t)]u(t) dt}_{\equiv f(x)} + \underbrace{\int_a^x r(t) dt}_{\equiv g(x)} + p_1(a)c_1 + c_2.$$

Integrating once more yields

$$\begin{aligned} u(x) &= -\int_a^x p_1(t)u(t) dt + \int_a^x f(s) ds + \int_a^x g(s) ds \\ &\quad + (x-a)[p_1(a)c_1 + c_2] \\ &= -\int_a^x p_1(t)u(t) dt + \int_a^x ds \int_a^s [p_1'(t) - p_0(t)]u(t) dt \\ &\quad + \int_a^x ds \int_a^s r(t) dt + (x-a)[p_1(a)c_1 + c_2] + c_1 \\ &= \int_a^x \{(x-t)[p_1'(t) - p_0(t)] - p_1(t)\}u(t) dt \\ &\quad + \int_a^x (x-t)r(t) dt + (x-a)[p_1(a)c_1 + c_2] + c_1, \quad (18.7) \end{aligned}$$

where we have used the formula

$$\int_a^x ds \int_a^s f(t) dt = \int_a^x (x-t)f(t) dt,$$

which the reader may verify by interchanging the order of integration on the LHS.

Proposition 18.1.3 *A SOLDE of the form (18.6) is equivalent to a Volterra equation of the second kind with kernel*

$$K(x, t) \equiv (x-t)[p_1'(t) - p_0(t)] - p_1(t)$$

and

$$v(x) \equiv \int_a^x (x-t)r(t) dt + (x-a)[p_1(a)c_1 + c_2] + c_1.$$

Neumann series solution

We now outline a systematic approach to obtaining the infinite series of Theorem 18.1.2, which also works for the Fredholm equation of the second kind. In the latter case, the series is guaranteed to converge only if $|\lambda| \|\mathbf{K}\| < 1$. This approach has the advantage that in each successive step, we obtain a better approximation to the solution. Writing the equation as

$$|u\rangle = |v\rangle + \lambda \mathbf{K}|u\rangle, \quad (18.8)$$

we can interpret it as follows. The difference between $|u\rangle$ and $|v\rangle$ is $\lambda\mathbf{K}|u\rangle$. If $\lambda\mathbf{K}$ were absent, the two vectors $|u\rangle$ and $|v\rangle$ would be equal. The effect of $\lambda\mathbf{K}$ is to change $|u\rangle$ in such a way that when the result is added to $|v\rangle$, it gives $|u\rangle$. As our initial approximation, therefore, we take $|u\rangle$ to be equal to $|v\rangle$ and write $|u_0\rangle = |v\rangle$, where the index reminds us of the order (in this case zeroth, because $\lambda\mathbf{K} = 0$) of the approximation. To find a better approximation, we always substitute the latest approximation for $|u\rangle$ in the RHS of Eq. (18.8). At this stage, we have $|u_1\rangle = |v\rangle + \lambda\mathbf{K}|u_0\rangle = |v\rangle + \lambda\mathbf{K}|v\rangle$. Still a better approximation is achieved if we substitute this expression in (18.8):

$$|u_2\rangle = |v\rangle + \lambda\mathbf{K}|u_1\rangle = |v\rangle + \lambda\mathbf{K}(|v\rangle + \lambda\mathbf{K}|v\rangle) = |v\rangle + \lambda\mathbf{K}|v\rangle + \lambda^2\mathbf{K}^2|v\rangle.$$

The procedure is now clear. Once $|u_n\rangle$, the n th approximation, is obtained, we can get $|u_{n+1}\rangle$ by substituting in the RHS of (18.8).

Before continuing, let us write the above equations in integral form. In what follows, we shall concentrate on the Fredholm equation. To obtain the result for the Volterra equation, one simply replaces b , the upper limit of integration, with x . The first approximation can be obtained by substituting $v(t)$ for $u(t)$ on the RHS of Eq. (18.1). This yields

$$u_1(x) = v(x) + \lambda \int_a^b K(x, t)v(t) dt.$$

Substituting this back in Eq. (18.1) gives

$$\begin{aligned} u_2(x) &= v(x) + \lambda \int_a^b ds K(x, s)u_1(s) \\ &= v(x) + \lambda \int_a^b ds K(x, s)v(s) \\ &\quad + \lambda^2 \int_a^b dt \left[\int_a^b K(x, s)K(s, t) ds \right] v(t) \\ &= v(x) + \lambda \int_a^b dt K(x, t)v(t) + \lambda^2 \int_a^b dt K^2(x, t)v(t), \end{aligned}$$

where $K^2(x, t) \equiv \int_a^b K(x, s)K(s, t) ds$. Similar expressions can be derived for $u_3(x)$, $u_4(x)$, and so forth. The integrals expressing various “powers” of K can be obtained using Dirac notation and vectors with continuous indices, as discussed in Sect. 7.3. Thus, for instance,

$$\begin{aligned} K^3(x, t) &\equiv \langle x | \underbrace{\mathbf{K} \left(\int_a^b |s_1\rangle \langle s_1| ds_1 \right)}_{=1} \underbrace{\mathbf{K} \left(\int_a^b |s_2\rangle \langle s_2| ds_2 \right)}_{=1} \mathbf{K} |t\rangle \\ &= \int_a^b ds_1 \int_a^b ds_2 \langle x | \mathbf{K} |s_1\rangle \langle s_1 | \mathbf{K} |s_2\rangle \langle s_2 | \mathbf{K} |t\rangle \\ &= \int_a^b ds_1 \int_a^b ds_2 K(x, s_1) K(s_1, s_2) K(s_2, t). \end{aligned}$$

We can always use this technique to convert an equation in kets into an equation in functions and integrals. Therefore, we can concentrate on the abstract operator equation and its various approximations.

Continuing to the n th-order approximation, we easily obtain

$$|u_n\rangle = |v\rangle + \lambda \mathbf{K}|v\rangle + \cdots + \lambda^n \mathbf{K}^n |v\rangle = \sum_{j=0}^n (\lambda \mathbf{K})^j |v\rangle, \quad (18.9)$$

whose integral form is

$$u_n(x) = \sum_{j=0}^n \lambda^j \int_a^b K^j(x, t) v(t) dt. \quad (18.10)$$

Here $K^j(x, t)$ is defined inductively by

$$\begin{aligned} K^0(x, t) &= \langle x | \mathbf{K}^0 | t \rangle = \langle x | \mathbf{1} | t \rangle = \langle x | t \rangle = \delta(x - t), \\ K^j(x, t) &= \langle x | \mathbf{K} \mathbf{K}^{j-1} | t \rangle = \langle x | \mathbf{K} \left(\int_a^b |s\rangle \langle s| ds \right) \mathbf{K}^{j-1} | t \rangle \\ &= \int_a^b K(x, s) K^{j-1}(s, t) ds. \end{aligned}$$

The limit of $u_n(x)$ as $n \rightarrow \infty$ gives

$$u(x) = \sum_{j=0}^{\infty} \lambda^j \int_a^b K^j(x, t) v(t) dt. \quad (18.11)$$

Neumann series The convergence of this series, called the **Neumann series**, is always guaranteed for the Volterra equation. For the Fredholm equation, we need to impose the extra condition $|\lambda| \|\mathbf{K}\| < 1$.

Example 18.1.4 As an example, let us find the solution of $u(x) = 1 + \lambda \int_0^x u(t) dt$, a Volterra equation of the second kind. Here, $v(x) = 1$ and $K(x, t) = 1$, and it is straightforward to calculate approximations to $u(x)$:

$$\begin{aligned} u_0(x) &= v(x) = 1, & u_1(x) &= 1 + \lambda \int_0^x K(x, t) u_0(t) dt = 1 + \lambda x, \\ u_2(x) &= 1 + \lambda \int_0^x K(x, t) u_1(t) dt = 1 + \lambda \int_0^x (1 + \lambda t) dt \\ &= 1 + \lambda x + \frac{\lambda^2 x^2}{2}. \end{aligned}$$

It is clear that the n th term will look like

$$u_n(x) = 1 + \lambda x + \frac{\lambda^2 x^2}{2} + \cdots + \frac{\lambda^n x^n}{n!} = \sum_{j=0}^n \frac{\lambda^j x^j}{j!}.$$

As $n \rightarrow \infty$, we obtain $u(x) = e^{\lambda x}$. By direct substitution, it is readily checked that this is indeed a solution of the original integral equation.

18.2 Fredholm Integral Equations

We can use our knowledge of compact operators gained in the previous chapter to study Fredholm equations of the second kind. With $\lambda \neq 0$ a complex number, we consider the characteristic equation

$$(\mathbf{1} - \lambda \mathbf{K})|u\rangle = |v\rangle, \quad \text{or} \quad u(x) - \lambda K[u](x) = v(x), \quad (18.12)$$

where all functions are square-integrable on $[a, b]$, and $K(x, t)$, the Hilbert-Schmidt kernel, is square-integrable on the rectangle $[a, b] \times [a, b]$.

Using Proposition 17.2.9, we immediately see that Eq. (18.12) has a unique solution if $|\lambda| \|\mathbf{K}\| < 1$, and the solution is of the form

$$|u\rangle = (\mathbf{1} - \lambda \mathbf{K})^{-1}|v\rangle = \sum_{n=0}^{\infty} \lambda^n \mathbf{K}^n |v\rangle, \quad (18.13)$$

or $u(x) = \sum_{n=0}^{\infty} \lambda^n K^n[v](x)$, where $K^n[v](x)$ is defined as in Eq. (18.4) except that now b replaces x as the upper limit of integration.

Example 18.2.1 Consider the integral equation

$$u(x) - \int_0^1 K(x, t)u(t) dt = x, \quad \text{where} \quad K(x, t) = \begin{cases} x & \text{if } 0 \leq x < t, \\ t & \text{if } t < x \leq 1. \end{cases}$$

Here $\lambda = 1$; therefore, a Neumann series solution exists if $\|\mathbf{K}\| < 1$. It is convenient to write K in terms of the theta function:¹

$$K(x, t) = x\theta(t - x) + t\theta(x - t). \quad (18.14)$$

This gives $|K(x, t)|^2 = x^2\theta(t - x) + t^2\theta(x - t)$ because $\theta^2(x - t) = \theta(x - t)$ and $\theta(x - t)\theta(t - x) = 0$. Thus, we have

$$\begin{aligned} \|\mathbf{K}\|^2 &= \int_0^1 dx \int_0^1 dt |K(x, t)|^2 \\ &= \int_0^1 dx \int_0^1 x^2 \theta(t - x) dt + \int_0^1 dx \int_0^1 t^2 \theta(x - t) dt \\ &= \int_0^1 dt \int_0^t x^2 dx + \int_0^1 dx \int_0^x t^2 dt \\ &= \int_0^1 dt \left(\frac{t^3}{3} \right) + \int_0^1 dx \left(\frac{x^3}{3} \right) = \frac{1}{6}. \end{aligned}$$

Since this is less than 1, the Neumann series converges, and we have²

¹Recall that the theta function is defined to be 1 if its argument is positive, and 0 if it is negative.

²Note that in this case (Fredholm equation), we can calculate the j th term in isolation. In the Volterra case, it was more natural to calculate the solution up to a given order.

$$u(x) = \sum_{j=0}^{\infty} \lambda^j \int_a^b K^j(x, t) v(t) dt = \sum_{j=0}^{\infty} \int_0^1 K^j(x, t) t dt \equiv \sum_{j=0}^{\infty} f_j(x).$$

The first few terms are evaluated as follows:

$$\begin{aligned} f_0(x) &= \int_0^1 K^0(x, t) t dt = \int_0^1 \delta(x, t) t dt = x \\ f_1(x) &= \int_0^1 K(x, t) t dt = \int_0^1 [x\theta(t-x) + t\theta(x-t)] t dt \\ &= x \int_x^1 t dt + \int_0^x t^2 dt = \frac{x}{2} - \frac{x^3}{6}. \end{aligned}$$

The next term is trickier than the first two because of the product of the theta functions. We first substitute Eq. (18.14) in the integral for the second-order term, and simplify

$$\begin{aligned} f_2(x) &= \int_0^1 K^2(x, t) t dt = \int_0^1 t dt \int_0^1 K(x, s) K(s, t) ds \\ &= \int_0^1 t dt \int_0^1 [x\theta(s-x) + s\theta(x-s)][s\theta(t-s) + t\theta(s-t)] ds \\ &= x \int_0^1 t dt \int_0^1 s\theta(s-x)\theta(t-s) ds \\ &\quad + x \int_0^1 t^2 dt \int_0^1 \theta(s-x)\theta(s-t) ds \\ &\quad + \int_0^1 t dt \int_0^1 s^2\theta(x-s)\theta(t-s) ds \\ &\quad + \int_0^1 t^2 dt \int_0^1 s\theta(x-s)\theta(s-t) ds. \end{aligned}$$

It is convenient to switch the order of integration at this point. This is because of the presence of $\theta(x-s)$ and $\theta(s-x)$, which do not involve t and are best integrated last. Thus, we have

$$\begin{aligned} f_2(x) &= x \int_0^1 s\theta(s-x) ds \int_s^1 t dt + x \int_0^1 \theta(s-x) ds \int_0^s t^2 dt \\ &\quad + \int_0^1 s^2\theta(x-s) ds \int_s^1 t dt + \int_0^1 s\theta(x-s) ds \int_0^s t^2 dt \\ &= x \int_x^1 s ds \left(\frac{1}{2} - \frac{s^2}{2} \right) + x \int_x^1 ds \frac{s^3}{3} + \int_0^x s^2 ds \left(\frac{1}{2} - \frac{s^2}{2} \right) \\ &\quad + \int_0^x s ds \frac{s^3}{3} \\ &= \frac{5}{24}x - \frac{1}{12}x^3 + \frac{1}{120}x^5. \end{aligned}$$

As a test of his/her knowledge of θ -function manipulation, the reader is urged to perform the integration in reverse order. Adding all the terms, we obtain an approximation for $u(x)$ that is valid for $0 \leq x \leq 1$:

$$u(x) \approx f_0(x) + f_1(x) + f_2(x) = \frac{41}{24}x - \frac{1}{4}x^3 + \frac{1}{120}x^5.$$

We have seen that the Volterra equation of the second kind has a unique solution which can be written as an infinite series (see Theorem 18.1.2). The case of the Fredholm equation of the second kind is more complicated because of the existence of eigenvalues. The general solution of Eq. (18.12) is discussed in the following:

Theorem 18.2.2 (Fredholm Alternative) *Let \mathbf{K} be a Hilbert-Schmidt operator and λ a complex number. Then either* Fredholm alternative

1. λ is a regular value of Eq. (18.12)—or λ^{-1} is a regular point of the operator \mathbf{K} —in which case the equation has the unique solution $|u\rangle = (\mathbf{1} - \lambda\mathbf{K})^{-1}|v\rangle$, or
2. λ is a characteristic value of Eq. (18.12) (λ^{-1} is an eigenvalue of the operator \mathbf{K}), in which case the equation has a solution if and only if $|v\rangle$ is in the orthogonal complement of the (finite-dimensional) null space of $\mathbf{1} - \lambda^*\mathbf{K}^\dagger$.

Proof The first part is trivial if we recall that by definition, regular points of \mathbf{K} are those complex numbers μ which make the operator $\mathbf{K} - \mu\mathbf{1}$ invertible.

For part (2), we first show that the null space of $\mathbf{1} - \lambda^*\mathbf{K}^\dagger$ is finite-dimensional. We note that $\mathbf{1} - \lambda\mathbf{K}$ is invertible if and only if its adjoint $\mathbf{1} - \lambda^*\mathbf{K}^\dagger$ is invertible, and $\lambda \in \rho(\mathbf{K})$ iff $\lambda^* \in \rho(\mathbf{K}^\dagger)$. Since the spectrum of an operator is composed of all points that are not regular, we conclude that λ is in the spectrum of \mathbf{K} if and only if λ^* is in the spectrum of \mathbf{K}^\dagger . For compact operators, all nonzero points of the spectrum are eigenvalues. Therefore, the nonzero points of the spectrum of \mathbf{K}^\dagger , a compact operator by Theorem 17.5.7, are all eigenvalues of \mathbf{K}^\dagger , and the null space of $\mathbf{1} - \lambda^*\mathbf{K}^\dagger$ is finite-dimensional (Theorem 17.5.11). Next, we note that the equation itself requires that $|v\rangle$ be in the range of the operator $\mathbf{1} - \lambda\mathbf{K}$, which, by Theorem 17.6.5, is the orthogonal complement of the null space of $\mathbf{1} - \lambda^*\mathbf{K}^\dagger$. \square

Historical Notes

Erik Ivar Fredholm (1866–1927) was born in Stockholm, the son of a well-to-do merchant family. He received the best education possible and soon showed great promise in mathematics, leaning especially toward the applied mathematics of practical mechanics in a year of study at Stockholm's Polytechnic Institute. Fredholm finished his education at the University of Uppsala, obtaining his doctorate in 1898. He also studied at the University of Stockholm during this same period and eventually received an appointment to the faculty there. Fredholm remained there the rest of his professional life.

His first contribution to mathematics was contained in his doctoral thesis, in which he studied a first-order partial differential equation in three variables, a problem that arises in the deformation of anisotropic media. Several years later he completed this work by finding the fundamental solution to a general elliptic partial differential equation with constant coefficients.



Erik Ivar Fredholm
1866–1927

Fredholm is perhaps best known for his studies of the integral equation that bears his name. Such equations occur frequently in physics. Fredholm’s genius led him to note the similarity between his equation and a relatively familiar matrix-vector equation, resulting in his identification of a quantity that plays the same role in his equation as the determinant plays in the matrix-vector equation. He thus obtained a method for determining the existence of a solution and later used an analogous expression to derive a solution to his equation akin to the Cramer’s rule solution to the matrix-vector equation. He further showed that the solution could be expressed as a power series in a complex variable. This latter result was considered important enough that Poincaré assumed it without proof (in fact he was unable to prove it) in a study of related partial differential equations. Fredholm then considered the homogeneous form of his equation. He showed that under certain conditions, the vector space of solutions is finite-dimensional. David Hilbert later extended Fredholm’s work to a complete eigenvalue theory of the Fredholm equation, which ultimately led to the discovery of Hilbert spaces.

18.2.1 Hermitian Kernel

Of special interest are integral equations in which the kernel is hermitian, which occurs when the operator is hermitian. Such a kernel has the property that³ $\langle x|\mathbf{K}|t\rangle^* = \langle t|\mathbf{K}|x\rangle$ or $[K(x, t)]^* = K(t, x)$. For such kernels we can use the spectral theorem for compact hermitian operators to find a series solution for the integral equation. First we recall that

$$\mathbf{K} = \sum_{j=1}^N \lambda_j^{-1} \mathbf{P}_j = \sum_{j=1}^N \lambda_j^{-1} \sum_{k=1}^{m_j} |e_k^{(j)}\rangle \langle e_k^{(j)}|,$$

where we have used λ_j^{-1} to denote the eigenvalue of the operator⁴ and expanded the projection operator in terms of orthonormal basis vectors of the corresponding finite-dimensional eigenspace. Recall that N can be infinity. Instead of the double sum, we can sum once over all the basis vectors and write $\mathbf{K} = \sum_{n=1}^\infty \lambda_n^{-1} |u_n\rangle \langle u_n|$. Here n counts all the orthonormal eigenvectors of the Hilbert space, and λ_n^{-1} is the eigenvalue corresponding to the eigenvector $|u_n\rangle$. Therefore, λ_n^{-1} may be repeated in the sum. The action of \mathbf{K} on a vector $|u\rangle$ is given by

$$\mathbf{K}|u\rangle = \sum_{n=1}^\infty \lambda_n^{-1} \langle u_n|u\rangle |u_n\rangle. \tag{18.15}$$

If the Hilbert space is $\mathcal{L}^2[a, b]$, we may be interested in the functional form of this equation. We obtain such a form by multiplying both sides by $\langle x|$:

$$K[u](x) \equiv \langle x|\mathbf{K}|u\rangle = \sum_{n=1}^\infty \lambda_n^{-1} \langle u_n|u\rangle \langle x|u_n\rangle = \sum_{n=1}^\infty \lambda_n^{-1} \langle u_n|u\rangle u_n(x).$$

Hilbert-Schmidt theorem

That this series converges *uniformly* in the interval $[a, b]$ is known as the **Hilbert-Schmidt theorem**.

³Since we are dealing mainly with real functions, hermiticity of \mathbf{K} implies the symmetry of K , i.e., $K(x, t) = K(t, x)$.

⁴ λ_j is the characteristic value of the integral equation, or the inverse of the eigenvalue of the corresponding operator.

Example 18.2.3 Let us solve $u(x) = x + \lambda \int_a^b K(x, t)u(t) dt$, where $K(x, t) \equiv xt$ is a symmetric (hermitian) kernel, by the Neumann series method. We note that

$$\begin{aligned}\|\mathbf{K}\|^2 &= \int_a^b \int_a^b |K(x, t)|^2 dx dt = \int_a^b \int_a^b x^2 t^2 dx dt \\ &= \int_a^b x^2 dx \int_a^b t^2 dt = \left(\int_a^b x^2 dx \right)^2 = \frac{1}{9}(b^3 - a^3)^2,\end{aligned}$$

or

$$\|\mathbf{K}\| = \int_a^b x^2 dx = \frac{1}{3}(b^3 - a^3),$$

and the Neumann series converges if $|\lambda|(b^3 - a^3) < 3$. Assuming that this condition holds, we have

$$u(x) = x + \sum_{j=1}^{\infty} \lambda^j \int_a^b K^j(x, t) t dt.$$

The special form of the kernel allows us to calculate $K^j(x, t)$ directly:

$$\begin{aligned}K^j(x, t) &= \int_a^b \int_a^b \dots \int_a^b K(x, s_1)K(s_1, s_2) \cdots K(s_{j-1}, t) ds_1 ds_2 \cdots ds_{j-1} \\ &= \int_a^b \int_a^b \dots \int_a^b x s_1^2 s_2^2 \cdots s_{j-1}^2 t ds_1 ds_2 \cdots ds_{j-1} \\ &= xt \left(\int_a^b s^2 ds \right)^{j-1} = xt \|\mathbf{K}\|^{j-1}.\end{aligned}$$

It follows that $\int_a^b K^j(x, t) t dt = x \|\mathbf{K}\|^{j-1} \frac{1}{3}(b^3 - a^3) = x \|\mathbf{K}\|^j$. Substituting this in the expression for $u(x)$ yields

$$\begin{aligned}u(x) &= x + \sum_{j=1}^{\infty} \lambda^j x \|\mathbf{K}\|^j = x + x \lambda \|\mathbf{K}\| \sum_{j=1}^{\infty} \lambda^{j-1} \|\mathbf{K}\|^{j-1} \\ &= x \left(1 + \lambda \|\mathbf{K}\| \frac{1}{1 - \lambda \|\mathbf{K}\|} \right) = \frac{x}{1 - \lambda \|\mathbf{K}\|} = \frac{3x}{3 - \lambda(b^3 - a^3)}.\end{aligned}$$

Because of the simplicity of the kernel, we can solve the integral equation exactly. First we write

$$u(x) = x + \lambda \int_a^b x t u(t) dt = x + \lambda x \int_a^b t u(t) dt \equiv x(1 + \lambda A), \quad (18.16)$$

where $A = \int_a^b t u(t) dt$. Multiplying both sides by x and integrating, we obtain

$$\begin{aligned}A &= \int_a^b x u(x) dx = (1 + \lambda A) \int_a^b x^2 dx = (1 + \lambda A) \|\mathbf{K}\| \\ \Rightarrow A &= \frac{\|\mathbf{K}\|}{1 - \lambda \|\mathbf{K}\|}.\end{aligned}$$

Substituting A in Eq. (18.16) gives

$$u(x) = x \left(1 + \lambda \frac{\|\mathbf{K}\|}{1 - \lambda \|\mathbf{K}\|} \right) = \frac{x}{1 - \lambda \|\mathbf{K}\|}.$$

This solution is the same as the first one we obtained. However, no series was involved here, and therefore no assumption is necessary concerning $|\lambda| \|\mathbf{K}\|$.

If one can calculate the eigenvectors $|u_n\rangle$ and the eigenvalues λ_n^{-1} , then one can obtain a solution for the integral equation in terms of these eigenfunctions as follows: Substitute (18.15) in the Fredholm equation [Eq. (18.3)] to get

$$|u\rangle = |v\rangle + \lambda \sum_{n=1}^{\infty} \lambda_n^{-1} \langle u_n | u \rangle |u_n\rangle. \quad (18.17)$$

Multiply both sides by $\langle u_m |$:

$$\begin{aligned} \langle u_m | u \rangle &= \langle u_m | v \rangle + \lambda \sum_{n=1}^{\infty} \lambda_n^{-1} \langle u_n | u \rangle \underbrace{\langle u_m | u_n \rangle}_{=\delta_{mn}} \\ &= \langle u_m | v \rangle + \lambda \lambda_m^{-1} \langle u_m | u \rangle, \end{aligned} \quad (18.18)$$

or, if λ is not one of the eigenvalues,

$$\left(1 - \frac{\lambda}{\lambda_m} \right) \langle u_m | u \rangle = \langle u_m | v \rangle \Rightarrow \langle u_m | u \rangle = \frac{\lambda_m \langle u_m | v \rangle}{\lambda_m - \lambda}.$$

Substituting this in Eq. (18.17) gives

$$|u\rangle = |v\rangle + \lambda \sum_{n=1}^{\infty} \frac{\langle u_n | v \rangle}{\lambda_n - \lambda} |u_n\rangle, \quad (18.19)$$

and in the functional form,

$$u(x) = v(x) + \lambda \sum_{n=1}^{\infty} \frac{\langle u_n | v \rangle}{\lambda_n - \lambda} u_n(x), \quad \lambda \neq \lambda_n \quad \forall n. \quad (18.20)$$

In case $\lambda = \lambda_m$ for some m , the Fredholm alternative (Theorem 18.2.2) says that we will have a solution only if $|v\rangle$ is in the orthogonal complement of the null space of $\mathbf{1} - \lambda_m \mathbf{K}$. Moreover, Eq. (18.18) shows that $\langle u_m | u \rangle$, the expansion coefficients of the basis vectors of the eigenspace \mathcal{M}_m , cannot be specified. However, Eq. (18.18) does determine the rest of the coefficients as before. In this case, the solution can be written as

$$|u\rangle = |v\rangle + \sum_{k=1}^r c_k |u_m^{(k)}\rangle + \lambda \sum_{\substack{n=1 \\ n \neq m}}^{\infty} \frac{\langle u_n | v \rangle}{\lambda_n - \lambda} |u_n\rangle, \quad (18.21)$$

⁵Remember that \mathbf{K} is hermitian; therefore, λ_m is real.

where r is the (finite) dimension of \mathcal{M}_m , k labels the orthonormal basis $\{|u_m^{(k)}\}$ of \mathcal{M}_m , and $\{c_k\}_{k=1}^r$ are arbitrary constants. In functional form, this equation becomes

$$u(x) = v(x) + \sum_{k=1}^r c_k u_m^{(k)}(x) + \lambda \sum_{\substack{n=1 \\ n \neq m}}^{\infty} \frac{\langle u_n | v \rangle}{\lambda_n - \lambda} u_n(x). \quad (18.22)$$

Example 18.2.4 We now give an example of the application of Eq. (18.20). We want to solve $u(x) = 3 \int_{-1}^1 K(x, t) u(t) dt + x^2$ where

$$K(x, t) = \sum_{k=0}^{\infty} \frac{u_k(x) u_k(t)}{2^{k/2}}, \quad u_k(x) = \sqrt{\frac{2k+1}{2}} P_k(x),$$

and $P_k(x)$ is a Legendre polynomial.

We first note that $\{u_k\}$ is an orthonormal set of functions, that $K(x, t)$ is real and symmetric (therefore, hermitian), and that

$$\begin{aligned} & \int_{-1}^1 dt \int_{-1}^1 dx |K(x, t)|^2 \\ &= \int_{-1}^1 dt \int_{-1}^1 dx \sum_{k,l=0}^{\infty} \frac{u_k(x) u_k(t)}{2^{k/2}} \frac{u_l(x) u_l(t)}{2^{l/2}} \\ &= \sum_{k,l=0}^{\infty} \frac{1}{2^{k/2}} \frac{1}{2^{l/2}} \underbrace{\int_{-1}^1 u_k(x) u_l(x) dx}_{=\delta_{kl}} \underbrace{\int_{-1}^1 u_k(t) u_l(t) dt}_{=\delta_{kl}} \\ &= \sum_{k=0}^{\infty} \frac{1}{2^k} \delta_{kk} = \sum_{k=0}^{\infty} \frac{1}{2^k} = 2 < \infty. \end{aligned}$$

Thus, $K(x, t)$ is a Hilbert-Schmidt kernel.

Now note that

$$\begin{aligned} \int_{-1}^1 K(x, t) u_k(t) dt &= \int_{-1}^1 \sum_{l=0}^{\infty} \frac{u_l(x) u_l(t)}{2^{l/2}} u_k(t) dt \\ &= \sum_{l=0}^{\infty} \frac{u_l(x)}{2^{l/2}} \underbrace{\int_{-1}^1 u_l(t) u_k(t) dt}_{=\delta_{kl}} = \frac{1}{2^{k/2}} u_k(x). \end{aligned}$$

This shows that u_k is an eigenfunction of $K(x, t)$ with eigenvalue $1/2^{k/2}$. Since $3 \neq 1/2^{k/2}$ for any integer k , we can use Eq. (18.20) to write

$$u(x) = x^2 + 3 \sum_{k=0}^{\infty} \frac{\int_{-1}^1 u_k(s) s^2 ds}{2^{k/2} - 3} u_k(x).$$

But $\int_{-1}^1 u_k(s)s^2 ds = 0$ for $k \geq 3$. For $k \leq 2$, we use the first three Legendre polynomials to get

$$\int_{-1}^1 u_0(s)s^2 ds = \frac{\sqrt{2}}{3}, \quad \int_{-1}^1 u_1(s)s^2 ds = 0,$$

$$\int_{-1}^1 u_2(s)s^2 ds = \frac{2\sqrt{2}}{3\sqrt{5}}.$$

This gives $u(x) = \frac{1}{2} - 2x^2$. The reader is urged to substitute this solution in the original integral equation and verify that it works.

18.2.2 Degenerate Kernels

degenerate or separable
kernel

The preceding example involves the simplest kind of degenerate, or separable, kernels. A kernel is called **degenerate**, or **separable**, if it can be written as a finite sum of products of functions of one variable:

$$K(x, t) = \sum_{j=1}^n \phi_j(x)\psi_j^*(t), \quad (18.23)$$

where ϕ_j and ψ_j are assumed to be square-integrable. Substituting (18.23) in the Fredholm integral equation of the second kind, we obtain

$$u(x) - \lambda \sum_{j=1}^n \phi_j(x) \int_a^b \psi_j^*(t)u(t) dt = v(x).$$

If we define $\mu_j = \int_a^b \psi_j^*(t)u(t) dt$, the preceding equation becomes

$$u(x) - \lambda \sum_{j=1}^n \mu_j \phi_j(x) = v(x). \quad (18.24)$$

Multiply this equation by $\psi_i^*(x)$ and integrate over x to get

$$\mu_i - \lambda \sum_{j=1}^n \mu_j A_{ij} = v_i \quad \text{for } i = 1, 2, \dots, n, \quad (18.25)$$

where $A_{ij} = \int_a^b \psi_i^*(t)\phi_j(t) dt$ and $v_i = \int_a^b \psi_i^*(t)v(t) dt$. With μ_i , v_i , and A_{ij} as components of column vectors \mathbf{u} , \mathbf{v} , and a matrix \mathbf{A} , we can write the above linear system of equations as

$$\mathbf{u} - \lambda \mathbf{A}\mathbf{u} = \mathbf{v}, \quad \text{or} \quad (1 - \lambda \mathbf{A})\mathbf{u} = \mathbf{v}. \quad (18.26)$$

We can now determine the μ_i by solving the system of linear equations given by (18.25). Once the μ_i are determined, Eq. (18.24) gives $u(x)$. Thus, for a degenerate kernel the Fredholm problem reduces to a system of linear equations.

Example 18.2.5 As a concrete example of an integral equation with degenerate kernel, we solve $u(x) - \lambda \int_0^1 (1 + xt)u(t) dt = x$ for two different values of λ . The kernel, $K(x, t) = 1 + xt$, is separable with $\phi_1(x) = 1$, $\psi_1(t) = 1$, $\phi_2(x) = x$, and $\psi_2(t) = t$. This gives the matrix

$$\mathbf{A} = \begin{pmatrix} 1 & \frac{1}{2} \\ \frac{1}{2} & \frac{1}{3} \end{pmatrix}.$$

For convenience, we define the matrix $\mathbf{B} \equiv \mathbf{1} - \lambda \mathbf{A}$.

- (a) First assume that $\lambda = 1$. In that case \mathbf{B} has a nonzero determinant. Thus, \mathbf{B}^{-1} exists, and can be calculated to be

$$\mathbf{B}^{-1} = \begin{pmatrix} -\frac{8}{3} & -2 \\ -2 & 0 \end{pmatrix}.$$

With

$$v_1 = \int_0^1 \psi_1^*(t)v(t) dt = \int_0^1 t dt = \frac{1}{2} \quad \text{and}$$

$$v_2 = \int_0^1 \psi_2^*(t)v(t) dt = \int_0^1 t^2 dt = \frac{1}{3}$$

we obtain

$$\begin{pmatrix} \mu_1 \\ \mu_2 \end{pmatrix} = \mathbf{B}^{-1} \mathbf{v} = \begin{pmatrix} -\frac{8}{3} & -2 \\ -2 & 0 \end{pmatrix} \begin{pmatrix} \frac{1}{2} \\ \frac{1}{3} \end{pmatrix} = \begin{pmatrix} -2 \\ -1 \end{pmatrix}.$$

Equation (18.24) then gives $u(x) = \mu_1 \phi_1(x) + \mu_2 \phi_2(x) + x = -2$.

- (b) Now, for the purpose of illustrating the other alternative of Theorem 18.2.2, let us take $\lambda = 8 + 2\sqrt{13}$. Then

$$\mathbf{B} = \mathbf{1} - \lambda \mathbf{A} = - \begin{pmatrix} 7 + 2\sqrt{13} & 4 + \sqrt{13} \\ 4 + \sqrt{13} & (5 + 2\sqrt{13})/3 \end{pmatrix},$$

and $\det \mathbf{B} = 0$. This shows that $8 + 2\sqrt{13}$ is a characteristic value of the equation. We thus have a solution only if $v(x) \equiv x$ is orthogonal to the null space of $\mathbf{1} - \lambda^* \mathbf{A}^\dagger = \mathbf{B}^\dagger$. To determine a basis for this null space, we have to find vectors $|z\rangle$ such that $\mathbf{B}^\dagger |z\rangle = 0$. Since λ is real, and \mathbf{B} is real and symmetric, $\mathbf{B}^\dagger = \mathbf{B}$, and we must solve

$$\begin{pmatrix} 7 + 2\sqrt{13} & 4 + \sqrt{13} \\ 4 + \sqrt{13} & (5 + 2\sqrt{13})/3 \end{pmatrix} \begin{pmatrix} \xi_1 \\ \xi_2 \end{pmatrix} = 0.$$

The solution to this equation is a multiple of $|z\rangle \equiv \begin{pmatrix} 3 \\ -2 - \sqrt{13} \end{pmatrix}$. If the integral equation is to have a solution, the column vector \mathbf{v} (whose corresponding ket we denote by $|v\rangle$) must be orthogonal to $|z\rangle$. But

$$\langle z|v\rangle = (3 \quad -2 - \sqrt{13}) \begin{pmatrix} \frac{1}{2} \\ \frac{1}{3} \end{pmatrix} \neq 0.$$

Therefore, the integral equation has no solution.

The reader may feel uneasy that the functions $\phi_j(x)$ and $\psi_j(t)$ appearing in a degenerate kernel are arbitrary to within a multiplicative function. After all, we can multiply $\phi_j(x)$ by a nonzero function, and divide $\psi_j(t)$ by the same function, and get the same kernel. Such a change clearly alters the matrices A and B and therefore seems likely to change the solution, $u(x)$. That this is not the case is demonstrated in Problem 18.2. In fact, it can be shown quite generally that the transformations described above do not change the solution.

As the alert reader may have noticed, we have been avoiding the problem of solving the eigenvalue (characteristic) problem for integral operators. Such a problem is nontrivial, and the analogue of the finite-dimensional case, where one works with determinants and characteristic polynomials, does not exist. An exception is a degenerate hermitian⁶ kernel, i.e., a kernel of the form $K(x, t) = \sum_{i=1}^n h_i(x)h_i^*(t)$. Substituting this in the characteristic-value equation

$$u(x) = \lambda \int_a^b K(x, t)u(t) dt, \quad \lambda \neq 0,$$

we obtain $u(x) = \lambda \sum_{i=1}^n h_i(x) \int_a^b h_i^*(t)u(t) dt$. Defining $\mu_i \equiv \int_a^b h_i^*(t) \times u(t) dt$ and substituting it back in the equation gives

$$u(x) = \lambda \sum_{i=1}^n h_i(x)\mu_i. \quad (18.27)$$

Multiplying this equation by $\lambda^{-1}h_k^*(x)$ and integrating over x yields

$$\lambda^{-1}\mu_k = \sum_{i=1}^n \left[\int_a^b h_k^*(x)h_i(x) dx \right] \mu_i \equiv \sum_{i=1}^n m_{ki}\mu_i.$$

This is an eigenvalue equation for the hermitian $n \times n$ matrix M with elements m_{ij} , which, by spectral theorem for hermitian operators, can be solved. In fact, the matrix need not be hermitian; as long as it is *normal*, the eigenvalue problem can be solved. Once the eigenvectors and the eigenvalues are found, we can substitute them in Eq. (18.27) and obtain $u(x)$. We expect to find a finite number of eigenfunctions and eigenvalues. Our analysis of compact operators included such a case. That analysis also showed that the entire (infinite-dimensional) Hilbert space could be written as the direct sum of eigenspaces that are finite-dimensional for nonzero eigenvalues. Therefore, we expect the eigenspace corresponding to the zero eigenvalue (or infinite characteristic value) to be infinite-dimensional. The following example illustrates these points.

Example 18.2.6 Let us find the nonzero characteristic values and corresponding eigenfunctions of the kernel $K(x, t) = 1 + \sin(x + t)$ for $-\pi \leq x, t \leq \pi$.

⁶Actually, the problem of a degenerate kernel that leads to a normal matrix, as described below, can also be solved.

We are seeking functions u and scalars λ satisfying $u(x) = \lambda K[u](x)$, or

$$u(x) = \lambda \int_{-\pi}^{\pi} [1 + \sin(x+t)]u(t) dt.$$

Expanding $\sin(x+t)$, we obtain

$$u(x) = \lambda \int_{-\pi}^{\pi} [1 + \sin x \cos t + \cos x \sin t]u(t) dt, \quad (18.28)$$

or

$$\lambda^{-1}u(x) = \mu_1 + \mu_2 \sin x + \mu_3 \cos x, \quad (18.29)$$

where $\mu_1 = \int_{-\pi}^{\pi} u(t) dt$, $\mu_2 = \int_{-\pi}^{\pi} u(t) \cos t dt$, and $\mu_3 = \int_{-\pi}^{\pi} u(t) \sin t dt$. Integrate both sides of Eq. (18.29) with respect to x from $-\pi$ to π to obtain $\lambda^{-1}\mu_1 = 2\pi\mu_1$. Similarly, multiplying by $\sin x$ and $\cos x$ and integrating yields

$$\lambda^{-1}\mu_2 = \pi\mu_3 \quad \text{and} \quad \lambda^{-1}\mu_3 = \pi\mu_2. \quad (18.30)$$

If $\mu_1 \neq 0$, we get $\lambda^{-1} = 2\pi$, which, when substituted in (18.30), yields $\mu_2 = \mu_3 = 0$. We thus have, as a first solution, $\lambda_1^{-1} = 2\pi$ and $|u_1\rangle = \alpha \begin{pmatrix} 1 \\ 0 \\ 0 \end{pmatrix}$, where α is an arbitrary constant. Equation (18.29) now gives $\lambda_1^{-1}u_1(x) = \mu_1$, or $u_1(x) = c_1$, where c_1 is an arbitrary constant to be determined.

On the other hand, $\mu_1 = 0$ if $\lambda^{-1} \neq 2\pi$. Then Eq. (18.30) yields $\lambda^{-1} = \pm\pi$ and $\mu_2 = \pm\mu_3$. For $\lambda^{-1} \equiv \lambda_+^{-1} = \pi$, Eq. (18.29) gives

$$u(x) \equiv u_+(x) = c_+(\sin x + \cos x),$$

and for $\lambda^{-1} \equiv \lambda_-^{-1} = -\pi$, it yields $u(x) \equiv u_-(x) = c_-(\sin x - \cos x)$, where c_{\pm} are arbitrary constants to be determined by normalization of eigenfunctions. The normalized eigenfunctions are

$$u_1 = \frac{1}{\sqrt{2\pi}}, \quad u_{\pm}(x) = \frac{1}{\sqrt{2\pi}}(\sin x \pm \cos x).$$

Direct substitution in the original integral equation easily verifies that u_1 , u_+ , and u_- are eigenfunctions of the integral equation with the eigenvalues calculated above.

Let us now consider the zero eigenvalue (or infinite characteristic value). Divide both sides of Eq. (18.28) by λ and take the limit of $\lambda \rightarrow \infty$. Then the integral equation becomes

$$\int_{-\pi}^{\pi} [1 + \sin x \cos t + \cos x \sin t]u(t) dt = 0.$$

The solutions $u(t)$ to this equation would span the eigenspace corresponding to the zero eigenvalue, or infinite characteristic value. We pointed out above that this eigenspace is expected to be infinite-dimensional. This expectation is borne out once we note that all functions of the form $\sin nt$ or $\cos nt$ with $n \geq 2$ make the above integral zero; and there are infinitely many such functions.

18.3 Problems

18.1 Use mathematical induction to derive Eq. (18.5).

18.2 Repeat part (a) of Example 18.2.5 using

$$\begin{aligned}\phi_1(x) &= \frac{1}{2}, & \psi_1(t) &= 2, \\ \phi_2(x) &= x, & \psi_2(t) &= t\end{aligned}$$

so that we still have $K(x, t) = \phi_1(x)\psi_1(t) + \phi_2(x)\psi_2(t)$.

18.3 Use the spectral theorem for compact hermitian operators to show that if the kernel of a Hilbert-Schmidt operator has a finite number of nonzero eigenvalues, then the kernel is separable. Hint: See the discussion at the beginning of Sect. 18.2.1.

18.4 Use the method of successive approximations to solve the Volterra equation $u(x) = \lambda \int_0^x u(t) dt$. Then derive a DE equivalent to the Volterra equation (make sure to include the initial condition), and solve it.

18.5 Regard the Fourier transform,

$$\mathbf{F}[f](x) \equiv \frac{1}{\sqrt{2\pi}} \int_{-\infty}^{\infty} e^{ixy} f(y) dy$$

as an integral operator.

- Show that $\mathbf{F}^2[f](x) = f(-x)$.
- Deduce, therefore, that the only eigenvalues of this operator are $\lambda = \pm 1, \pm i$.
- Let $f(x)$ be any even function of x . Show that an appropriate choice of α can make $u = f + \alpha \mathbf{F}[f]$ an eigenfunction of \mathbf{F} . (This shows that the eigenvalues of \mathbf{F} have infinite multiplicity.)

18.6 For what values of λ does the following integral equation have a solution?

$$u(x) = \lambda \int_0^\pi \sin(x+t)u(t) dt + x.$$

What is that solution? Redo the problem using a Neumann series expansion. Under what condition is the series convergent?

18.7 It is possible to multiply the functions $\phi_j(x)$ by $\gamma_j(x)$ and $\psi_j(t)$ by $1/\gamma_j(t)$ and still get the same degenerate kernel, $K(x, t) = \sum_{j=1}^n \phi_j(x)\psi_j(t)$. Show that such arbitrariness, although affecting the matrices \mathbf{A} and \mathbf{B} , does not change the solution of the Fredholm problem

$$u(x) - \lambda \int_a^b K(x, t)u(t) dt = f(x).$$

18.8 Show, by direct substitution, that the solution found in Example 18.2.4 does satisfy its integral equation.

18.9 Solve $u(x) = \frac{1}{2} \int_{-1}^1 (x+t)u(t) dt + x$.

18.10 Solve $u(x) = \lambda \int_0^1 xtu(t) dt + x$ using the Neumann series method. For what values of λ is the series convergent? Now find the eigenvalues and eigenfunctions of the kernel and solve the problem using these eigenvalues and eigenfunctions.

18.11 Solve $u(x) = \lambda \int_0^\infty K(x,t)u(t)dt + x^\alpha$, where α is any real number except a negative integer, and $K(x,t) = e^{-(x+t)}$. For what values of λ does the integral equation have a solution?

18.12 Solve the integral equations

$$(a) \quad u(x) = e^x + \lambda \int_0^1 xtu(t) dt, \quad (b) \quad u(x) = \lambda \int_0^\pi \sin(x-t)u(t) dt,$$

$$(c) \quad u(x) = x^2 + \int_0^1 xtu(t) dt, \quad (d) \quad u(x) = x + \int_0^x u(t) dt.$$

18.13 Solve the integral equation $u(x) = x + \lambda \int_0^1 (x+t)tu(t) dt$, keeping terms up to λ^2 .

18.14 Solve the integral equation $u(x) = e^{-|x|} + \lambda \int_{-\infty}^\infty e^{-|x-t|}u(t) dt$, assuming that f remains finite as $x \rightarrow \pm\infty$.

18.15 Solve the integral equation $u(x) = e^{-|x|} + \lambda \int_0^\infty u(t) \cos xt dt$, assuming that f remains finite as $x \rightarrow \pm\infty$.

The linear operators discussed in the last two chapters were exclusively *integral* operators. Most applications of physical interest, however, involve *differential* operators (DO). Unfortunately, differential operators are unbounded. We noted that complications arise when one abandons the compactness property of the operator, e.g., sums turn into integrals and one loses one’s grip over the eigenvalues of noncompact operators. The transition to unbounded operators complicates matters even more. Fortunately, the formalism of one type of DOs that occur most frequently in physics can be studied in the context of compact operators. Such a study is our aim for this chapter.

19.1 Compact-Resolvent Unbounded Operators

As was pointed out in Example 17.2.7, the derivative operator cannot be defined for *all* functions in $\mathcal{L}^2(a, b)$. This motivates the following:

Definition 19.1.1 Let \mathcal{D} be a linear manifold¹ in the Hilbert space \mathcal{H} . A linear map $\mathbf{T} : \mathcal{D} \rightarrow \mathcal{H}$ will be called a **linear operator in**² \mathcal{H} . \mathcal{D} is called the **domain** of \mathbf{T} and often denoted by $\mathcal{D}(\mathbf{T})$.

domain of a linear operator

Example 19.1.2 The domain of the derivative operator \mathbf{D} , as an operator on $\mathcal{L}^2(a, b)$, cannot be the entire space. On the other hand, \mathbf{D} is defined on the linear manifold \mathcal{M} in $\mathcal{L}^2(a, b)$ spanned by $\{e^{i2n\pi x/L}\}$ with $L = b - a$. As we saw in Chap. 9, \mathcal{M} is dense (see Definition 17.4.5 and the discussion following it) in $\mathcal{L}^2(a, b)$. This is the essence of Fourier series: That every function in $\mathcal{L}^2(a, b)$ can be expanded in (i.e., approximated by) a Fourier series. It turns out that many unbounded operators on a Hilbert space share the same property, namely that their domains are dense in the Hilbert space.

¹A linear manifold of an infinite-dimensional normed vector space \mathcal{V} is a proper subset that is a vector space in its own right, *but is not necessarily closed*.

²As opposed to *on* \mathcal{H} .

Another important property of Fourier expansion is the fact that if the function is differentiable, then one can differentiate both sides, i.e., one can differentiate a Fourier expansion term by term if such an operation makes sense for the original function. Define the sequence $\{f_m\}$ by

$$f_m(x) = \sum_{n=-m}^m a_n e^{i2\pi nx/L}, \quad a_n = \frac{1}{\sqrt{L}} \int_a^b f(x) e^{-i2\pi nx/L} dx.$$

Then we can state the property above as follows: Suppose $\{f_m\}$ is in \mathcal{M} . If $\lim f_m = f$ and $\lim f'_m = g$, then $f' = g$ and $f \in \mathcal{M}$. Many unbounded operators share this property.

Definition 19.1.3 Let \mathcal{D} be a linear manifold in the Hilbert space \mathcal{H} . Let $\mathbf{T} : \mathcal{D} \rightarrow \mathcal{H}$ be a linear operator in \mathcal{H} . Suppose that for any sequence $\{|u_n\rangle\}$ in \mathcal{D} , both $\{|u_n\rangle\}$ and $\{\mathbf{T}|u_n\rangle\}$ converge in \mathcal{H} , i.e.,

$$\lim |u_n\rangle = |u\rangle \quad \text{and} \quad \lim \mathbf{T}|u_n\rangle = |v\rangle.$$

closed operator We say that \mathbf{T} is **closed** if $|v\rangle \in \mathcal{D}$ and $\mathbf{T}|u\rangle = |v\rangle$.

Notice that we cannot demand that $|v\rangle$ be in \mathcal{D} for a general operator. This, as we saw in the preceding example, will not be appropriate for unbounded operators.

The restriction of the domain of an unbounded operator is necessitated by the fact that the action of the operator on a vector in the Hilbert space in general takes that vector out of the space. The following theorem (see [DeVi 90, pp. 251–252] for a proof) shows why this is necessary:

Theorem 19.1.4 A closed linear operator in \mathcal{H} that is defined at every point of \mathcal{H} (so that $\mathcal{D} = \mathcal{H}$) is bounded.

Thus, if we are interested in unbounded operators (for instance, differential operators), we *have to* restrict their domains. In particular, we have to accept the possibility of an operator whose adjoint has a different domain.³

difference between hermitian and self-adjoint operators

Definition 19.1.5 Let \mathbf{T} be a linear operator in \mathcal{H} . We shall say that \mathbf{T} is **hermitian** if \mathbf{T}^\dagger is an **extension** of \mathbf{T} , i.e., $\mathcal{D}(\mathbf{T}) \subset \mathcal{D}(\mathbf{T}^\dagger)$ and $\mathbf{T}^\dagger|u\rangle = \mathbf{T}|u\rangle$ for all $|u\rangle \in \mathcal{D}(\mathbf{T})$. \mathbf{T} is called **self-adjoint** if $\mathcal{D}(\mathbf{T}) = \mathcal{D}(\mathbf{T}^\dagger)$.

As we shall see shortly, certain types of Sturm-Liouville operators, although unbounded, lend themselves to a study within the context of compact operators.

operators with compact resolvent

Definition 19.1.6 A hermitian linear operator \mathbf{T} in a Hilbert space \mathcal{H} is said to have a **compact resolvent** if there is a $\mu \in \rho(\mathbf{T})$ for which the resolvent $\mathbf{R}_\mu(\mathbf{T})$ is compact.

³This subtle difference between hermitian and self-adjoint is stated here merely to warn the reader and will be confined to the present discussion. The two qualifiers will be (ab)used interchangeably in the rest of the book.

An immediate consequence of this definition is that $\mathbf{R}_\lambda(\mathbf{T})$ is compact for all $\lambda \in \rho(\mathbf{T})$. To see this, note that $\mathbf{R}_\lambda(\mathbf{T})$ is bounded by Definition 17.3.1. Now use Eq. (17.7) and write

$$\mathbf{R}_\lambda(\mathbf{T}) = [\mathbf{1} + (\lambda - \mu)\mathbf{R}_\lambda(\mathbf{T})]\mathbf{R}_\mu(\mathbf{T}).$$

The RHS is a product of a bounded⁴ and a compact operator, and therefore must be compact. The compactness of the resolvent characterizes its spectrum by Theorem 17.6.8. As the following theorem shows, this in turn characterizes the spectrum of the operators with compact resolvent.

Theorem 19.1.7 *Let \mathbf{T} be an operator with compact resolvent $\mathbf{R}_\lambda(\mathbf{T})$ where $\lambda \in \rho(\mathbf{T})$. Then $0 \neq \mu \in \rho(\mathbf{R}_\lambda(\mathbf{T}))$ if and only if $(\lambda + 1/\mu) \in \rho(\mathbf{T})$. Similarly, $\mu \neq 0$ is an eigenvalue of $\mathbf{R}_\lambda(\mathbf{T})$ if and only if $(\lambda + 1/\mu)$ is an eigenvalue of \mathbf{T} . Furthermore, the eigenvectors of $\mathbf{R}_\lambda(\mathbf{T})$ corresponding to μ coincide with those of \mathbf{T} corresponding to $(\lambda + 1/\mu)$.*

Proof The proof consists of a series of two-sided implications involving definitions. We give the proof of the first part, the second part being very similar:

$$\begin{aligned} \mu \in \rho(\mathbf{R}_\lambda(\mathbf{T})) & \quad \text{iff} & \quad \mathbf{R}_\lambda(\mathbf{T}) - \mu\mathbf{1} & \quad \text{is invertible.} \\ \mathbf{R}_\lambda(\mathbf{T}) - \mu\mathbf{1} & \quad \text{is invertible iff} & \quad (\mathbf{T} - \lambda\mathbf{1})^{-1} - \mu\mathbf{1} & \quad \text{is invertible.} \\ (\mathbf{T} - \lambda\mathbf{1})^{-1} - \mu\mathbf{1} & \quad \text{is invertible iff} & \quad \mathbf{1} - \mu(\mathbf{T} - \lambda\mathbf{1}) & \quad \text{is invertible.} \\ \mathbf{1} - \mu(\mathbf{T} - \lambda\mathbf{1}) & \quad \text{is invertible iff} & \quad \frac{1}{\mu}\mathbf{1} - \mathbf{T} + \lambda\mathbf{1} & \quad \text{is invertible.} \\ \left(\frac{1}{\mu} + \lambda\right)\mathbf{1} - \mathbf{T} & \quad \text{is invertible iff} & \quad \left(\frac{1}{\mu} + \lambda\right) \in \rho(\mathbf{T}). \end{aligned}$$

Comparing the LHS of the first line with the RHS of the last line, we obtain the first part of the theorem. □

A consequence of this theorem and Theorem 17.5.11 is that the eigenspaces of an (unbounded) operator with compact resolvent are finite-dimensional, i.e., such an operator has only finitely many eigenvectors corresponding to each of its eigenvalues. Moreover, arranging the eigenvalues μ_n of the resolvent in decreasing order (as done in Theorem 17.6.8), we conclude that the eigenvalues of \mathbf{T} can be arranged in a sequence in increasing order of their absolute values and the limit of this sequence is infinity.

Example 19.1.8 Consider the operator \mathbf{T} in $\mathcal{L}^2(0, 1)$ defined by⁵ $\mathbf{T}f = -f''$ having the domain

⁴The sum of two bounded operators is bounded.

⁵We shall depart from our convention here and shall not use the Dirac bar-ket notation although the use of abstract operators encourages their use. The reason is that in this example, we are dealing with functions, and it is more convenient to undress the functions from their Dirac clothing.

$$\mathcal{D}(\mathbf{T}) = \{f \in \mathcal{L}^2(0, 1) \mid f'' \in \mathcal{L}^2(0, 1), f(0) = f(1) = 0\}.$$

The reader may check that zero is not an eigenvalue of \mathbf{T} . Therefore, we may choose $\mathbf{R}_0(\mathbf{T}) = \mathbf{T}^{-1}$. We shall study a systematic way of finding inverses of some specific differential operators in the upcoming chapters on Green's functions. At this point, suffice it to say that \mathbf{T}^{-1} can be written as a Hilbert-Schmidt integral operator with kernel

$$K(x, t) = \begin{cases} x(1-t) & \text{if } 0 \leq x \leq t \leq 1, \\ (1-x)t & \text{if } 0 \leq t \leq x \leq 1. \end{cases}$$

Thus, if $\mathbf{T}f = g$, i.e., if $f'' = -g$, then $\mathbf{T}^{-1}g = f$, or $f = K[g]$, i.e.,

$$\begin{aligned} f(x) &= K[g](x) = \int_0^1 K(x, t)g(t) dt \\ &= \int_0^x (1-x)tg(t) dt + \int_x^1 (1-x)tg(t) dt. \end{aligned}$$

It is readily verified that $K[g](0) = K[g](1) = 0$ and $f''(x) = K[g]''(x) = -g$.

We can now use Theorem 19.1.7 with $\lambda = 0$ to find all the eigenvalues of \mathbf{T} : μ_n is an eigenvalue of \mathbf{T} if and only if $1/\mu_n$ is an eigenvalue of \mathbf{T}^{-1} . These eigenvalues should have finite-dimensional eigenspaces, and we should be able to arrange them in increasing order of magnitude without bound. To verify this, we solve $f'' = -\mu f$, whose solutions are $\mu_n = n^2\pi^2$ and $f_n(x) = \sin n\pi x$. Note that there is only one eigenfunction corresponding to each eigenvalue. Therefore, the eigenspaces are finite- (one-) dimensional.

The example above is a special case of a large class of DOs occurring in mathematical physics. Recall from Theorem 14.5.4 that all linear second-order differential equations can be made self-adjoint. Moreover, Proposition 14.4.11 showed that any SOLDE can be transformed into a form in which the first-derivative term is absent. By dividing the DE by the coefficient of the second-derivative term if necessary, the study of the most general second-order linear differential operators boils down to that of the so-called

Sturm-Liouville operators **Sturm-Liouville (S-L) operators**

$$\mathbf{L}_x \equiv \frac{d^2}{dx^2} - q(x), \tag{19.1}$$

which are assumed to be self-adjoint. Differential operators are necessarily accompanied by boundary conditions that specify their domains. So, to be complete, let us assume that the DO in Eq. (19.1) acts on the subset of $\mathcal{L}^2(a, b)$ consisting of functions u that satisfy the following so-called **separated boundary conditions**:

separated boundary conditions

$$\begin{aligned} \alpha_1 u(a) + \beta_1 u'(a) &= 0, \\ \alpha_2 u(b) + \beta_2 u'(b) &= 0, \end{aligned} \tag{19.2}$$

where $\alpha_1, \alpha_2, \beta_1,$ and β_2 are real constants with the property that the matrix of coefficients has no zero rows. The collection of the DO and the boundary conditions above is called a **regular Sturm-Liouville system**.

regular Sturm-Liouville systems

We now show that the DO of a regular Sturm-Liouville system has compact resolvent. First observe that by adding αu —with α an arbitrary number different from all eigenvalues of the DO—to both sides of the eigenvalue equation $u'' - qu = \lambda u$, we can assume⁶ that zero is not an eigenvalue of \mathbf{L}_x . Next, suppose that $u_1(x)$ and $u_2(x)$ are the two linearly independent solutions of the homogeneous DE satisfying the first and the second boundary conditions of Eq. (19.2), respectively. The operator whose kernel is

$$K(x, t) = \begin{cases} -u_1(x)u_2(t)/W(a) & \text{if } a \leq x \leq t \leq b, \\ -u_1(t)u_2(x)/W(a) & \text{if } a \leq t \leq x \leq b, \end{cases}$$

in which W is the Wronskian of the solutions, is a Hilbert-Schmidt operator and therefore compact. We now show that $K(x, t)$ is the resolvent $\mathbf{R}_0(\mathbf{L}_x) = \mathbf{L}_x^{-1} \equiv \mathbf{K}$ of our DO. To see this, write $\mathbf{L}_x u = v$, and

$$u(x) = K[v](x) = -\frac{u_2(x)}{W(a)} \int_a^x u_1(t)v(t) dt - \frac{u_1(x)}{W(a)} \int_x^b u_2(t)v(t) dt.$$

Differentiating this once gives

$$u'(x) = -\frac{u_2'(x)}{W(a)} \int_a^x u_1(t)v(t) dt - \frac{u_1'(x)}{W(a)} \int_x^b u_2(t)v(t) dt,$$

and a second differentiation yields

$$u''(x) = -\frac{u_2''(x)}{W(a)} \int_a^x u_1(t)v(t) dt - \frac{u_1''(x)}{W(a)} \int_x^b u_2(t)v(t) dt + v(x).$$

The last equation follows from the fact that the Wronskian $u_1'u_2 - u_2'u_1$ is constant for a DE of the form $u'' - qu = 0$. By substituting $u_1'' = qu_1$ and $u_2'' = qu_2$ in the last equation, we verify that $u = K[v]$ is indeed a solution of the Sturm-Liouville system $\mathbf{L}_x u = v$.

Next, we show that the eigensolutions of the S-L system are nondegenerate, i.e., the eigenspaces are one-dimensional. Suppose f_1 and f_2 are any two eigenfunctions corresponding to the same eigenvalue. Then both must satisfy the same DE and the same boundary conditions; in particular, we must have

$$\begin{aligned} \alpha_1 f_1(a) + \beta_1 f_1'(a) = 0 \\ \alpha_1 f_2(a) + \beta_1 f_2'(a) = 0 \end{aligned} \Rightarrow \begin{pmatrix} f_1(a) & f_1'(a) \\ f_2(a) & f_2'(a) \end{pmatrix} \begin{pmatrix} \alpha_1 \\ \beta_1 \end{pmatrix} = \begin{pmatrix} 0 \\ 0 \end{pmatrix}. \quad (19.3)$$

If α_1 and β_1 are not both zero, the Wronskian—the determinant of the matrix above—must vanish. Therefore, the two functions must be linearly dependent. Finally, recall that a Hilbert space on which a compact operator \mathbf{K} is defined can be written as a direct sum of the latter's eigenspaces.

⁶Although this will change q —and the original operator—no information will be lost because the eigenvectors will be the same and all eigenvalues will be changed by α .

More specifically, $\mathcal{H} = \sum_{j=0}^N \oplus \mathcal{M}_j$, where each \mathcal{M}_j is finite-dimensional for $j = 1, 2, \dots$, and N can be finite or infinite. If N is finite, then \mathcal{M}_0 , which can be considered as the eigenspace of zero eigenvalue,⁷ will be infinite-dimensional. If \mathcal{M}_0 is finite-dimensional (or absent), then N must be infinite, and the eigenvectors of \mathbf{K} will span the entire space, i.e., they will form a complete orthogonal system. We now show that this holds for the regular Sturm-Liouville operator.



Jacques Charles Francois
Sturm 1803–1855

Historical Notes

Jacques Charles Francois Sturm (1803–1855) made the first accurate determination of the velocity of sound in water in 1826, working with the Swiss engineer Daniel Colladon. He became a French citizen in 1833 and worked in Paris at the *École Polytechnique* where he became a professor in 1838. In 1840 he succeeded Poisson in the chair of mechanics in the *Faculté des Sciences*, Paris.

The problems of determining the eigenvalues and eigenfunctions of an ordinary differential equation with boundary conditions and of expanding a given function in terms of an infinite series of the eigenfunctions, which date from about 1750, became more prominent as new coordinate systems were introduced and new classes of functions arose as the eigenfunctions of ordinary differential equations. Sturm and his friend Joseph Liouville decided to tackle the general problem for any second-order linear differential equation.

Sturm had been working since 1833 on problems of partial differential equations, primarily on the flow of heat in a bar of variable density, and hence was fully aware of the eigenvalue and eigenfunction problem. The mathematical ideas he applied to this problem are closely related to his investigations of the reality and distribution of the roots of algebraic equations. His ideas on differential equations, he says, came from the study of difference equations and a passage to the limit. Liouville, informed by Sturm of the problems he was working on, took up the same subject. The results of their joint work was published in several papers which are quite detailed.

Suppose that the above Hilbert-Schmidt operator \mathbf{K} has a zero eigenvalue. Then, there must exist a nonzero function v such that $K[v](x) = 0$, i.e.,

$$-\frac{u_2(x)}{W(a)} \int_a^x u_1(t)v(t) dt - \frac{u_1(x)}{W(a)} \int_x^b u_2(t)v(t) dt = 0 \quad (19.4)$$

for all x . Differentiate this twice to get

$$-\frac{u_2''(x)}{W(a)} \int_a^x u_1(t)v(t) dt - \frac{u_1''(x)}{W(a)} \int_x^b u_2(t)v(t) dt + v(x) = 0.$$

Now substitute $u_1'' = qu_1$ and $u_2'' = qu_2$ in this equation and use Eq. (19.4) to conclude that $v = 0$. This is impossible because no eigenvector can be zero. Hence, zero is not an eigenvalue of \mathbf{K} , i.e., $\mathcal{M}_0 = \{0\}$. Since eigenvectors of $\mathbf{K} = \mathbf{L}_x^{-1}$ coincide with eigenvectors of \mathbf{L}_x , and eigenvalues of \mathbf{L}_x are the reciprocals of the eigenvalues of \mathbf{K} , we have the following result.

Theorem for regular
Sturm-Liouville systems

Theorem 19.19 *A regular Sturm-Liouville system has a countable number of eigenvalues that can be arranged in an increasing sequence that has infinity as its limit. The eigenvectors of the Sturm-*

⁷The reader recalls that when \mathbf{K} acts on \mathcal{M}_0 , it yields zero.

Liouville operator are nondegenerate and constitute a complete orthogonal set. Furthermore, the eigenfunction $u_n(x)$ corresponding to the eigenvalue λ_n has exactly n zeros in its interval of definition.

The last statement is not a result of operator theory, but can be derived using the theory of differential equations. We shall not present the details of its derivation. We need to emphasize that the boundary conditions are an integral part of S-L systems. Changing the boundary conditions so that, for example, they are no longer separated may destroy the regularity of the S-L system.

19.2 Sturm-Liouville Systems and SOLDEs

We are now ready to combine our discussion of the preceding section with the knowledge gained from our study of differential equations. We saw in Chap. 13 that the separation of PDEs normally results in expressions of the form

$$\mathbf{L}[u] + \lambda u = 0, \quad \text{or} \quad p_2(x) \frac{d^2 u}{dx^2} + p_1(x) \frac{du}{dx} + p_0(x)u + \lambda u = 0, \quad (19.5)$$

where u is a function of a single variable and λ is, a priori, an arbitrary constant. This is an eigenvalue equation for the operator \mathbf{L} , which is not, in general, self-adjoint. If we use Theorem 14.5.4 and multiply (19.5) by

$$w(x) = \frac{1}{p_2(x)} \exp \left[\int^x \frac{p_1(t)}{p_2(t)} dt \right],$$

it becomes self-adjoint for real λ , and can be written as

$$\frac{d}{dx} \left[p(x) \frac{du}{dx} \right] + [\lambda w(x) - q(x)]u = 0 \quad (19.6)$$

with $p(x) = w(x)p_2(x)$ and $q(x) = -p_0(x)w(x)$. Equation (19.6) is the standard form of the S-L equation. However, it is not in the form studied in the previous section. To turn it into that form one changes both the independent and dependent variables via the so-called **Liouville substitution**:

Liouville substitution

$$u(x) = v(t) [p(x)w(x)]^{-1/4}, \quad t = \int_a^x \sqrt{\frac{w(s)}{p(s)}} ds. \quad (19.7)$$

It is then a matter of chain-rule differentiation to show that Eq. (19.6) becomes

$$\frac{d^2 v}{dt^2} + [\lambda - Q(t)]v = 0, \quad (19.8)$$

where

$$Q(t) = \frac{q(x(t))}{w(x(t))} + [p(x(t))w(x(t))]^{-1/4} \frac{d^2}{dt^2} [(pw)^{1/4}].$$

Therefore, Theorem 19.1.9 still holds.

Historical Notes



Joseph Liouville
1809–1882

Joseph Liouville (1809–1882) was a highly respected professor at the *Collège de France*, in Paris, and the founder and editor of the *Journal des Mathématiques Pures et Appliquées*, a famous periodical that played an important role in French mathematical life through the latter part of the nineteenth century. His own remarkable achievements as a creative mathematician have only recently received the appreciation they deserve.

He was the first to solve a boundary value problem by solving an equivalent integral equation. His ingenious theory of fractional differentiation answered the long-standing question of what reasonable meaning can be assigned to the symbol $d^n y/dx^n$ when n is not a positive integer. He discovered the fundamental result in complex analysis that a bounded entire function is necessarily a constant and used it as the basis for his own theory of elliptic functions. There is also a well-known **Liouville theorem** in Hamiltonian mechanics, which states that volume integrals are time-invariant in phase space. In collaboration with Sturm, he also investigated the eigenvalue problem of second-order differential equations.

The theory of transcendental numbers is another branch of mathematics that originated in Liouville's work. The irrationality of π and e (the fact that they are not solutions of any linear equations) had been proved in the eighteenth century by Lambert and Euler. In 1844 Liouville showed that e is not a root of any quadratic equation with integral coefficients as well. This led him to conjecture that e is transcendental, which means that it does not satisfy any polynomial equation with integral coefficients.

Example 19.2.1 The Liouville substitution [Eq. (19.7)] transforms the Bessel DE $(xu')' + (k^2x - v^2/x)u = 0$ into

$$\frac{d^2v}{dt^2} + \left[k^2 - \frac{v^2 - 1/4}{t^2} \right] v = 0,$$

from which we can obtain an interesting result when $v = \frac{1}{2}$. In that case we have $\ddot{v} + k^2v = 0$, whose solutions are of the form $\cos kt$ and $\sin kt$. Noting that $u(x) = J_{1/2}(x)$, Eq. (19.7) gives

$$J_{1/2}(kt) = A \frac{\sin kt}{\sqrt{t}} \quad \text{or} \quad J_{1/2}(kt) = B \frac{\cos kt}{\sqrt{t}},$$

and since $J_{1/2}(x)$ is analytic at $x = 0$, we must have $J_{1/2}(kt) = A \sin kt/\sqrt{t}$, which is the result obtained in Chap. 15.

The appearance of w is the result of our desire to render the differential operator self-adjoint. It also appears in another context. Recall the Lagrange identity for a self-adjoint differential operator \mathbf{L} :

$$u\mathbf{L}[v] - v\mathbf{L}[u] = \frac{d}{dx} \{ p(x)[u(x)v'(x) - v(x)u'(x)] \}. \quad (19.9)$$

If we specialize this identity to the S-L equation of (19.6) with $u = u_1$ corresponding to the eigenvalue λ_1 and $v = u_2$ corresponding to the eigenvalue λ_2 , we obtain for the LHS

$$u_1\mathbf{L}[u_2] - u_2\mathbf{L}[u_1] = u_1(-\lambda_2 w u_2) + u_2(\lambda_1 w u_1) = (\lambda_1 - \lambda_2) w u_1 u_2.$$

Integrating both sides of (19.9) then yields

$$(\lambda_1 - \lambda_2) \int_a^b w u_1 u_2 dx = \left\{ p(x) [u_1(x) u_2'(x) - u_2(x) u_1'(x)] \right\}_a^b. \quad (19.10)$$

A desired property of the solutions of a self-adjoint DE is their orthogonality when they belong to different eigenvalues. This property will be satisfied if we assume an inner product integral with weight function $w(x)$, and if the RHS of Eq. (19.10) vanishes. There are various boundary conditions that fulfill the latter requirement. For example, u_1 and u_2 could satisfy the boundary conditions of Eq. (19.2). Another set of appropriate boundary conditions (BC) is the **periodic BC** given by

periodic boundary conditions

$$u(a) = u(b) \quad \text{and} \quad u'(a) = u'(b). \quad (19.11)$$

However, as the following example shows, the latter BCs do not lead to a regular S-L system.

Example 19.2.2 The following examples show how BC can change the S-L systems.

- (a) The S-L system consisting of the S-L equation $d^2u/dt^2 + \omega^2u = 0$ in the interval $[0, T]$ with the separated BCs $u(0) = 0$ and $u(T) = 0$ has the eigenfunctions $u_n(t) = \sin \frac{n\pi}{T}t$ with $n = 1, 2, \dots$ and the eigenvalues $\lambda_n = \omega_n^2 = (n\pi/T)^2$ with $n = 1, 2, \dots$
- (b) Let the S-L equation be the same as in part (a) but change the interval to $[-T, +T]$ and the BCs to a periodic one such as $u(-T) = u(T)$ and $u'(-T) = u'(T)$. The eigenvalues are the same as before, but the eigenfunctions are $1, \sin(n\pi t/T),$ and $\cos(n\pi t/T),$ where n is a positive integer. Note that there is a degeneracy here in the sense that there are two linearly independent eigenfunctions having the same eigenvalue $(n\pi/T)^2$. By Theorem 19.1.9, the S-L system is not regular.
- (c) The Bessel equation for a given fixed v^2 is

$$u'' + \frac{1}{x}u' + \left(k^2 - \frac{v^2}{x^2}\right)u = 0, \quad \text{where } a \leq x \leq b,$$

and it can be turned into an S-L system if we multiply it by

$$w(x) = \frac{1}{p_2(x)} \exp \left[\int^x \frac{p_1(t)}{p_2(t)} dt \right] = \exp \left[\int^x \frac{dt}{t} \right] = x.$$

Then we can write

$$\frac{d}{dx} \left(x \frac{du}{dx} \right) + \left(k^2x - \frac{v^2}{x} \right) u = 0,$$

which is in the form of Eq. (19.6) with $p = w = x,$ $\lambda = k^2,$ and $q(x) = v^2/x.$ If $a > 0,$ we can obtain a regular S-L system by applying appropriate separated BCs.

A regular S-L system is too restrictive for applications where either a or b or both may be infinite or where either a or b may be a singular point of the S-L equation. A **singular S-L system** is one for which one or more of the following conditions hold:

1. The interval $[a, b]$ stretches to infinity in either or both directions.
2. Either p or w vanishes at one or both end points a and b .
3. The function $q(x)$ is not continuous in $[a, b]$.
4. Any one of the functions $p(x)$, $q(x)$, and $w(x)$ is singular at a or b .

Even though the conclusions concerning eigenvalues of a regular S-L system cannot be generalized to the singular S-L system, the orthogonality of eigenfunctions corresponding to different eigenvalues can, as long as the eigenfunctions are square-integrable with weight function $w(x)$:

Box 19.2.3 *The eigenfunctions of a singular S-L system are orthogonal if the RHS of (19.10) vanishes.*

Example 19.2.4 Bessel functions $J_\nu(x)$ are entire functions. Thus, they are square-integrable in the interval $[0, b]$ for any finite positive b . For fixed ν the DE

$$r^2 \frac{d^2 u}{dr^2} + r \frac{du}{dr} + (k^2 r^2 - \nu^2)u = 0 \quad (19.12)$$

transforms into the Bessel equation $x^2 u'' + xu' + (x^2 - \nu^2)u = 0$ if we make the substitution $kr = x$. Thus, the solution of the *singular* S-L equation (19.12) that is analytic at $r = 0$ and corresponds to the eigenvalue k^2 is $u_k(r) = J_\nu(kr)$. For two different eigenvalues, k_1^2 and k_2^2 , the eigenfunctions are orthogonal if the boundary term of (19.10) corresponding to Eq. (19.12) vanishes, that is, if

$$\left\{ r \left[J_\nu(k_1 r) J'_\nu(k_2 r) - J_\nu(k_2 r) J'_\nu(k_1 r) \right] \right\}_0^b$$

vanishes, which will occur if and only if $J_\nu(k_1 b) J'_\nu(k_2 b) - J_\nu(k_2 b) J'_\nu(k_1 b) = 0$. A common choice is to take $J_\nu(k_1 b) = 0 = J_\nu(k_2 b)$, that is, to take both $k_1 b$ and $k_2 b$ as (different) roots of the Bessel function of order ν . We thus have $\int_0^b r J_\nu(k_i r) J_\nu(k_j r) dr = 0$ if k_i and k_j are different roots of $J_\nu(kb) = 0$.

The Legendre equation

$$\frac{d}{dx} \left[(1-x^2) \frac{du}{dx} \right] + \lambda u = 0, \quad \text{where } -1 < x < 1,$$

is already self-adjoint. Thus, $w(x) = 1$, and $p(x) = 1 - x^2$. The eigenfunctions of this singular S-L system [singular because $p(1) = p(-1) = 0$] are regular at the end points $x = \pm 1$ and are the Legendre polynomials $P_n(x)$ corresponding to $\lambda = n(n+1)$. The boundary term of (19.10) clearly vanishes at $a = -1$ and $b = +1$. Since $P_n(x)$ are square-integrable on $[-1, +1]$,

we obtain the familiar orthogonality relation: $\int_{-1}^{+1} P_n(x)P_m(x) dx = 0$ if $m \neq n$.

The Hermite DE is

$$u'' - 2xu' + \lambda u = 0. \quad (19.13)$$

It is transformed into an S-L system if we multiply it by $w(x) = e^{-x^2}$. The resulting S-L equation is

$$\frac{d}{dx} \left[e^{-x^2} \frac{du}{dx} \right] + \lambda e^{-x^2} u = 0. \quad (19.14)$$

The boundary term corresponding to the two eigenfunctions $u_1(x)$ and $u_2(x)$ having the respective eigenvalues λ_1 and $\lambda_2 \neq \lambda_1$ is

$$\left\{ e^{-x^2} [u_1(x)u_2'(x) - u_2(x)u_1'(x)] \right\}_a^b.$$

This vanishes for arbitrary u_1 and u_2 (because they are Hermite polynomials) if $a = -\infty$ and $b = +\infty$.

The function u is an eigenfunction of (19.14) corresponding to the eigenvalue λ if and only if it is a solution of (19.13). Solutions of this DE corresponding to $\lambda = 2n$ are the Hermite polynomials $H_n(x)$ discussed in Chap. 8. We can therefore write $\int_{-\infty}^{+\infty} e^{-x^2} H_n(x)H_m(x) dx = 0$ if $m \neq n$. This orthogonality relation was also derived in Chap. 8.

19.3 Asymptotic Behavior

The S-L problem is central to the solution of many DEs in mathematical physics. In some cases the S-L equation has a direct bearing on the physics. For example, the eigenvalue λ may correspond to the orbital angular momentum of an electron in an atom (see the treatment of spherical harmonics in Chap. 13) or to the energy levels of a particle in a potential (see Example 15.5.1). In many cases, then, it is worthwhile to gain some knowledge of the behavior of an S-L system in the limit of large λ —high angular momentum or high energy. Similarly, it is useful to understand the behavior of the solutions for large values of their arguments. We therefore devote this section to a discussion of the behavior of solutions of an S-L system in the limit of large eigenvalues and large independent variable.

19.3.1 Large Eigenvalues

We assume that the S-L operator has the form given in Eq. (19.1). This can always be done for an arbitrary second-order linear DE by multiplying it by a proper function (to make it self-adjoint) followed by a Liouville substitution. So, consider an S-L systems of the following form:

$$u'' + [\lambda - q(x)]u \equiv u'' + Q(x)u = 0 \quad \text{where } Q = \lambda - q \quad (19.15)$$

with separated BCs of (19.2). Let us assume that $Q(x) > 0$ for all $x \in [a, b]$, that is, $\lambda > q(x)$. This is reasonable, since we are interested in very large λ .

The study of the system of (19.15) and (19.2) is simplified if we make the **Prüfer substitution**:

$$u = RQ^{-1/4} \sin \phi, \quad u' = RQ^{1/4} \cos \phi, \quad (19.16)$$

where $R(x, \lambda)$ and $\phi(x, \lambda)$ are λ -dependent functions of x . This substitution transforms the S-L equation of (19.15) into a pair of equations (see Problem 19.3):

$$\begin{aligned} \frac{d\phi}{dx} &= \sqrt{\lambda - q(x)} - \frac{q'}{4[\lambda - q(x)]} \sin 2\phi, \\ \frac{dR}{dx} &= \frac{Rq'}{4[\lambda - q(x)]} \cos 2\phi. \end{aligned} \quad (19.17)$$

The function $R(x, \lambda)$ is assumed to be positive because any negativity of u can be transferred to the phase $\phi(x, \lambda)$. Also, R cannot be zero at any point of $[a, b]$, because both u and u' would vanish at that point, and, by Lemma 14.3.3, $u(x) = 0$. Equation (19.17) is very useful in discussing the asymptotic behavior of solutions of S-L systems both when $\lambda \rightarrow \infty$ and when $x \rightarrow \infty$. Before we discuss such asymptotics, we need to make a digression.

It is often useful to have a notation for the behavior of a function $f(x, \lambda)$ for large λ and all values of x . If the function remains bounded for all values of x as $\lambda \rightarrow \infty$, we write $f(x, \lambda) = O(1)$. Intuitively, this means that as λ gets larger and larger, the magnitude of the function $f(x, \lambda)$ remains of order 1. In other words, for no value of x is $\lim_{\lambda \rightarrow \infty} f(x, \lambda)$ infinite. If $\lambda^n f(x, \lambda) = O(1)$, then we can write $f(x, \lambda) = O(1)/\lambda^n$. This means that as λ tends to infinity, $f(x, \lambda)$ goes to zero as fast as $1/\lambda^n$ does. Sometimes this is written as $f(x, \lambda) = O(\lambda^{-n})$. Some properties of $O(1)$ are as follows:

1. If a is a finite real number, then $O(1) + a = O(1)$.
2. $O(1) + O(1) = O(1)$, and $O(1)O(1) = O(1)$.
3. For finite a and b , $\int_a^b O(1) dx = O(1)$.
4. If r and s are real numbers with $r \leq s$, then

$$O(1)\lambda^r + O(1)\lambda^s = O(1)\lambda^s.$$

5. If $g(x)$ is any bounded function of x , then a Taylor series expansion yields

$$\begin{aligned} [\lambda + g(x)]^r &= \lambda^r \left[1 + \frac{g(x)}{\lambda} \right]^r \\ &= \lambda^r \left\{ 1 + r \frac{g(x)}{\lambda} + \frac{r(r-1)}{2} \left[\frac{g(x)}{\lambda} \right]^2 + \frac{O(1)}{\lambda^3} \right\} \\ &= \lambda^r + r g(x) \lambda^{r-1} + O(1) \lambda^{r-2} = \lambda^r + O(1) \lambda^{r-1} \\ &= O(1) \lambda^r. \end{aligned}$$

Returning to Eq. (19.17) and expanding its RHSs using property 5, we obtain

$$\frac{d\phi}{dx} = \sqrt{\lambda} + \frac{O(1)}{\sqrt{\lambda}} + \frac{O(1)}{\lambda} = \sqrt{\lambda} + \frac{O(1)}{\sqrt{\lambda}}, \quad \frac{dR}{dx} = \frac{O(1)}{\lambda}.$$

Taylor series expansion of $\phi(x, \lambda)$ and $R(x, \lambda)$ about $x = a$ then yields

$$\begin{aligned} \phi(x, \lambda) &= \phi(a, \lambda) + (x - a)\sqrt{\lambda} + \frac{O(1)}{\sqrt{\lambda}}, \\ R(x, \lambda) &= R(a, \lambda) + \frac{O(1)}{\lambda} \end{aligned} \tag{19.18}$$

for $\lambda \rightarrow \infty$. These results are useful in determining the behavior of λ_n for large n . As an example, we use (19.2) and (19.16) to write

$$\begin{aligned} -\frac{\alpha_1}{\beta_1} &= \frac{u'(a)}{u(a)} = \frac{R(a, \lambda)Q^{1/4}(a, \lambda) \cos[\phi(a, \lambda)]}{R(a, \lambda)Q^{-1/4}(a, \lambda) \sin[\phi(a, \lambda)]} \\ &= Q^{1/2}(a, \lambda) \cot[\phi(a, \lambda)], \end{aligned}$$

where we have assumed that $\beta_1 \neq 0$. If $\beta_1 = 0$, we can take the ratio β_1/α_1 , which is finite because at least one of the two constants must be different from zero. Let $A = -\alpha_1/\beta_1$ and write $\cot[\phi(a, \lambda)] = A/\sqrt{\lambda - q(a)}$. Similarly, $\cot[\phi(b, \lambda)] = B/\sqrt{\lambda - q(b)}$, where $B = -\alpha_2/\beta_2$. Let us concentrate on the n th eigenvalue and write

$$\phi(a, \lambda_n) = \cot^{-1} \frac{A}{\sqrt{\lambda_n - q(a)}}, \quad \phi(b, \lambda_n) = \cot^{-1} \frac{A}{\sqrt{\lambda_n - q(b)}}.$$

For large λ_n the argument of \cot^{-1} is small. Therefore, we can expand the RHS in a Taylor series about zero:

$$\cot^{-1} \epsilon = \cot^{-1}(0) - \epsilon + \dots = \frac{\pi}{2} - \epsilon + \dots = \frac{\pi}{2} + \frac{O(1)}{\sqrt{\lambda_n}}$$

for $\epsilon = O(1)/\sqrt{\lambda_n}$. It follows that

$$\phi(a, \lambda_n) = \frac{\pi}{2} + \frac{O(1)}{\sqrt{\lambda_n}}, \quad \phi(b, \lambda_n) = \frac{\pi}{2} + n\pi + \frac{O(1)}{\sqrt{\lambda_n}}. \tag{19.19}$$

The term $n\pi$ appears in (19.19) because, by Theorem 19.1.9, the n th eigenfunction has n zeros between a and b . Since $u = RQ^{-1/4} \sin \phi$, this means that $\sin \phi$ must go through n zeros as x goes from a to b . Thus, at $x = b$ the phase ϕ must be $n\pi$ larger than at $x = a$.

Substituting $x = b$ in the first equation of (19.18), with $\lambda \rightarrow \lambda_n$, and using (19.19), we obtain

$$\frac{\pi}{2} + n\pi + \frac{O(1)}{\sqrt{\lambda_n}} = \frac{\pi}{2} + \frac{O(1)}{\sqrt{\lambda_n}} + (b - a)\sqrt{\lambda_n} + \frac{O(1)}{\sqrt{\lambda_n}},$$

or

$$(b - a)\sqrt{\lambda_n} = n\pi + \frac{O(1)}{\sqrt{\lambda_n}}. \tag{19.20}$$

One consequence of this result is that, $\lim_{n \rightarrow \infty} n\lambda_n^{-1/2} = (b - a)/\pi$. Thus, $\sqrt{\lambda_n} = C_n n$, where $\lim_{n \rightarrow \infty} C_n = \pi/(b - a)$, and Eq. (19.20) can be rewritten as

$$\sqrt{\lambda_n} = \frac{n\pi}{b - a} + \frac{O(1)}{C_n n} = \frac{n\pi}{b - a} + \frac{O(1)}{n}. \tag{19.21}$$

This equation describes the asymptotic behavior of eigenvalues. The following theorem, stated without proof, describes the asymptotic behavior of eigenfunctions.

Theorem 19.3.1 *Let $\{u_n(x)\}_{n=0}^\infty$ be the normalized eigenfunctions of the regular S-L system given by Eqs. (19.15) and (19.2) with $\beta_1\beta_2 \neq 0$. Then,*

asymptotic behavior of solutions of large order

for $n \rightarrow \infty$,

$$u_n(x) = \sqrt{\frac{2}{b - a}} \cos \frac{n\pi(x - a)}{b - a} + \frac{O(1)}{n}.$$

Example 19.3.2 Let us derive an asymptotic formula for the Legendre polynomials $P_n(x)$. We first make the Liouville substitution to transform the Legendre DE $[(1 - x^2)P']' + n(n + 1)P_n = 0$ into

$$\frac{d^2v}{dt^2} + [\lambda_n - Q(t)]v = 0, \quad \text{where } \lambda_n = n(n + 1). \tag{19.22}$$

Here $p(x) = 1 - x^2$ and $w(x) = 1$, so $t = \int^x ds/\sqrt{1 - s^2} = \cos^{-1} x$, or $x(t) = \cos t$, and

$$P_n(x(t)) = v(t)[1 - x^2(t)]^{-1/4} = \frac{v(t)}{\sqrt{\sin t}}. \tag{19.23}$$

In Eq. (19.22)

$$\begin{aligned} Q(t) &= (1 - x^2)^{-1/4} \frac{d^2}{dt^2} [(1 - x^2)^{1/4}] \\ &= \frac{1}{\sqrt{\sin t}} \frac{d^2}{dt^2} [\sqrt{\sin t}] = -\frac{1}{4} \left(1 + \frac{1}{\sin^2 t} \right). \end{aligned}$$

For large n we can neglect $Q(t)$, make the approximation $\lambda_n \approx (n + \frac{1}{2})^2$, and write $\ddot{v} + (n + \frac{1}{2})^2 v = 0$, whose general solution is

$$v(t) = A \cos \left[\left(n + \frac{1}{2} \right) t + \alpha \right],$$

where A and α are arbitrary constants. Substituting this solution in (19.23) yields $P_n(\cos t) = A \cos[(n + \frac{1}{2})t + \alpha]/\sqrt{\sin t}$. To determine α we note that $P_n(0) = 0$ if n is odd. Thus, if we let $t = \pi/2$, the cosine term vanishes for odd n if $\alpha = -\pi/4$. Thus, the general asymptotic formula for Legendre polynomials is

$$P_n(\cos t) = \frac{A}{\sqrt{\sin t}} \cos \left[\left(n + \frac{1}{2} \right) t - \frac{\pi}{4} \right] \quad \text{for } n \rightarrow \infty.$$

19.3.2 Large Argument

Liouville and Prüfer substitutions are useful in investigating the behavior of the solutions of S-L systems for large x as well. The general procedure is to transform the DE into the form of Eq. (19.8) by the Liouville substitution; then make the Prüfer substitution of (19.16) to obtain two DEs in the form of (19.17). Solving Eq. (19.17) when $x \rightarrow \infty$ determines the behavior of ϕ and R and, subsequently, of u , the solution. Problem 19.4 illustrates this procedure for the Bessel functions. We simply quote the results:

$$J_\nu(x) = \sqrt{\frac{2}{\pi x}} \cos \left[x - \left(\nu + \frac{1}{2} \right) \frac{\pi}{2} + \frac{\nu^2 - 1/4}{2x} \right] + \frac{O(1)}{x^{5/2}},$$

$$Y_\nu(x) = \sqrt{\frac{2}{\pi x}} \sin \left[x - \left(\nu + \frac{1}{2} \right) \frac{\pi}{2} + \frac{\nu^2 - 1/4}{2x} \right] + \frac{O(1)}{x^{5/2}}.$$

These two relations easily yield the asymptotic expressions for the Hankel functions:

$$H_\nu^{(1)}(x) = J_\nu(x) + iY_\nu(x)$$

$$= \sqrt{\frac{2}{\pi x}} \exp \left\{ i \left[x - \left(\nu + \frac{1}{2} \right) \frac{\pi}{2} + \frac{\nu^2 - 1/4}{2x} \right] \right\} + \frac{O(1)}{x^{5/2}},$$

$$H_\nu^{(2)}(x) = J_\nu(x) - iY_\nu(x)$$

$$= \sqrt{\frac{2}{\pi x}} \exp \left\{ -i \left[x - \left(\nu + \frac{1}{2} \right) \frac{\pi}{2} + \frac{\nu^2 - 1/4}{2x} \right] \right\} + \frac{O(1)}{x^{5/2}}.$$

If the last term in the exponent—which vanishes as $x \rightarrow \infty$ —is ignored, the asymptotic expression for $H_\nu^{(1)}(x)$ matches what was obtained in Chap. 16 using the method of steepest descent.

19.4 Expansions in Terms of Eigenfunctions

Chapter 13 showed how the solution of many PDEs can be written as the product of the solutions of the separated ODEs. These DEs are usually of Sturm-Liouville type. We saw this in the construction of spherical harmonics. In the rest of this chapter, consisting mainly of illustrative examples, we shall consider the use of other coordinate systems and construct solutions to DEs as infinite series expansions in terms of S-L eigenfunctions.

Central to the expansion of solutions in terms of S-L eigenfunctions is the question of their completeness. This completeness was established for a *regular* S-L system in Theorem 19.1.9.

We shall shortly state an analogous theorem (without proof) that establishes the completeness of the eigenfunctions of more general S-L systems. This theorem requires the following generalization of the separated and the

periodic BCs:

$$\begin{aligned}\mathbf{R}_1 u &\equiv \alpha_{11}u(a) + \alpha_{12}u'(a) + \alpha_{13}u(b) + \alpha_{14}u'(b) = 0, \\ \mathbf{R}_2 u &\equiv \alpha_{21}u(a) + \alpha_{22}u'(a) + \alpha_{23}u(b) + \alpha_{24}u'(b) = 0,\end{aligned}\tag{19.24}$$

where α_{ij} are numbers such that the rank of the following matrix is 2:

$$\mathbf{a} = \begin{pmatrix} \alpha_{11} & \alpha_{12} & \alpha_{13} & \alpha_{14} \\ \alpha_{21} & \alpha_{22} & \alpha_{23} & \alpha_{24} \end{pmatrix}.$$

The separated BCs correspond to the case for which $\alpha_{11} = \alpha_1$, $\alpha_{12} = \beta_1$, $\alpha_{23} = \alpha_2$, and $\alpha_{24} = \beta_2$, with all other α_{ij} zero. Similarly, the periodic BC is a special case for which $\alpha_{11} = -\alpha_{13} = \alpha_{22} = -\alpha_{24} = 1$, with all other α_{ij} zero. It is easy to verify that the rank of the matrix \mathbf{a} is 2 for these two special cases. Let

$$\mathcal{U} = \{u \in \mathcal{C}^2[a, b] \mid \mathbf{R}_j u = 0, \text{ for } j = 1, 2\}\tag{19.25}$$

be a subspace of $\mathcal{L}_w^2(a, b)$, and—to assure the vanishing of the RHS of the Lagrange identity—assume that the following equality holds:

$$p(b) \det \begin{pmatrix} \alpha_{11} & \alpha_{12} \\ \alpha_{21} & \alpha_{22} \end{pmatrix} = p(a) \det \begin{pmatrix} \alpha_{13} & \alpha_{14} \\ \alpha_{23} & \alpha_{24} \end{pmatrix}.\tag{19.26}$$

We are now ready to consider the theorem (for a proof, see [Hell 67, Chap. 7]).

Theorem 19.4.1 *The eigenfunctions $\{u_n(x)\}_{n=1}^\infty$ of an S-L system consisting of the S-L equation $(pu')' + (\lambda w - q)u = 0$ and the BCs of (19.24) form a complete basis of the subspace \mathcal{U} of $\mathcal{L}_w^2(a, b)$ described in (19.25). The eigenvalues are real and countably infinite and each one has a multiplicity of at most 2. They can be ordered according to size $\lambda_1 \leq \lambda_2 \leq \dots$, and their only limit point is $+\infty$.*

First note that Eq. (19.26) contains both separated and periodic BCs as special cases (Problem 19.5). In the case of periodic BCs, we assume that $p(a) = p(b)$. Thus, all the eigenfunctions discussed so far are covered by Theorem 19.4.1. Second, the orthogonality of eigenfunctions corresponding to different eigenvalues and the fact that there are infinitely many distinct eigenvalues assure the existence of infinitely many eigenfunctions. Third, the eigenfunctions form a basis of \mathcal{U} and not the whole $\mathcal{L}_w^2(a, b)$. Only those functions $u \in \mathcal{L}_w^2(a, b)$ that satisfy the BC in (19.24) are expandable in terms of $u_n(x)$. Finally, the last statement of Theorem 19.4.1 is a repetition of part of Theorem 19.1.9 but is included because the conditions under which Theorem 19.4.1 holds are more general than those applying to Theorem 19.1.9.

Part II discussed orthogonal functions in detail and showed how other functions can be expanded in terms of them. However, the procedure used in Part II was ad hoc from a logical standpoint. After all, the orthogonal

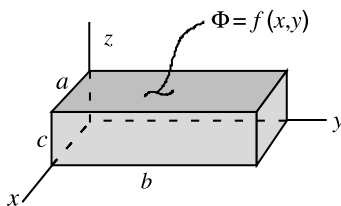

Fig. 19.1 A rectangular conducting box of which one face is held at the potential $f(x, y)$ and the other faces are grounded

polynomials were invented by nineteenth-century mathematical physicists who, in their struggle to solve the PDEs of physics using the separation of variables, came across various ODEs of the second order, all of which were recognized later as S-L systems. From a logical standpoint, therefore, this chapter should precede Part II. But the order of the chapters was based on clarity and ease of presentation and the fact that the machinery of differential equations was a prerequisite for such a discussion.

Theorem 19.4.1 is the important link between the algebraic and the analytic machinery of differential equation theory. This theorem puts at our disposal concrete mathematical functions that are calculable to any desired accuracy (on a computer, say) and can serve as basis functions for all the expansions described in Part II. The remainder of this chapter is devoted to solving some PDEs of mathematical physics using the separation of variables and Theorem 19.4.1.

19.5 Separation in Cartesian Coordinates

Problems most suitable for Cartesian coordinates have boundaries with rectangular symmetry such as boxes or planes.

19.5.1 Rectangular Conducting Box

Consider a rectangular conducting box with sides a , b , and c (see Fig. 19.1). All faces are held at zero potential except the top face, whose potential is given by a function $f(x, y)$. Let us find the potential at all points inside the box.

The relevant PDE for this situation is Laplace's equation, $\nabla^2\Phi = 0$. Writing $\Phi(x, y, z)$ as a product of three functions, $\Phi(x, y, z) = X(x)Y(y)Z(z)$, yields three ODEs (see Problem 19.6):

$$\frac{d^2X}{dx^2} + \lambda X = 0, \quad \frac{d^2Y}{dy^2} + \mu Y = 0, \quad \frac{d^2Z}{dz^2} + \nu Z = 0, \quad (19.27)$$

where $\lambda + \mu + \nu = 0$. The vanishing of Φ at $x = 0$ and $x = a$ means that

$$\Phi(0, y, z) = X(0)Y(y)Z(z) = 0 \quad \forall y, z \Rightarrow X(0) = 0,$$

$$\Phi(a, y, z) = X(a)Y(y)Z(z) = 0 \quad \forall y, z \Rightarrow X(a) = 0.$$

We thus obtain an S-L system, $X'' + \lambda X = 0$, $X(0) = 0 = X(a)$, whose BC is neither separated nor periodic, but satisfies (19.24) with $\alpha_{11} = \alpha_{23} = 1$ and all other α_{ij} zero. This S-L system has the eigenvalues and eigenfunctions

$$\lambda_n = \left(\frac{n\pi}{a}\right)^2 \quad \text{and} \quad X_n(x) = \sin\left(\frac{n\pi}{a}x\right) \quad \text{for } n = 1, 2, \dots$$

Similarly, the second equation in (19.27) leads to

$$\mu_m = \left(\frac{m\pi}{b}\right)^2 \quad \text{and} \quad Y_m(y) = \sin\left(\frac{m\pi}{b}y\right) \quad \text{for } m = 1, 2, \dots$$

On the other hand, the third equation in (19.27) does not lead to an S-L system because the BC for the top of the box does not fit (19.24). This is as expected because the “eigenvalue” ν is already determined by λ and μ . Nevertheless, we can find a solution for that equation. The substitution

$$\gamma_{mn}^2 = \left(\frac{n\pi}{a}\right)^2 + \left(\frac{m\pi}{b}\right)^2$$

changes the Z equation to $Z'' - \gamma_{mn}^2 Z = 0$, whose solution, consistent with $Z(0) = 0$, is $Z(z) = C_{mn} \sinh(\gamma_{mn}z)$.

We note that $X(x)$ and $Y(y)$ are functions satisfying $\mathbf{R}_1 X = 0 = \mathbf{R}_2 X$. Thus, by Theorem 19.4.1, they can be written as a linear combination of $X_n(x)$ and $Y_m(y)$:

$$X(x) = \sum_{n=1}^{\infty} A_n \sin(n\pi x/a) \quad \text{and} \quad Y(y) = \sum_{m=1}^{\infty} B_m \sin(m\pi b/y).$$

Consequently, the most general solution can be expressed as

$$\begin{aligned} \Phi(x, y, z) &= X(x)Y(y)Z(z) \\ &= \sum_{n=1}^{\infty} \sum_{m=1}^{\infty} A_{mn} \sin\left(\frac{n\pi}{a}x\right) \sin\left(\frac{m\pi}{b}y\right) \sinh(\gamma_{mn}z), \end{aligned}$$

where $A_{mn} = A_n B_m C_{mn}$.

To specify Φ completely, we must determine the arbitrary constants A_{mn} . This is done by imposing the remaining BC, $\Phi(x, y, c) = f(x, y)$, yielding the identity

$$\begin{aligned} f(x, y) &= \sum_{n=1}^{\infty} \sum_{m=1}^{\infty} A_{mn} \sin\left(\frac{n\pi}{a}x\right) \sin\left(\frac{m\pi}{b}y\right) \sinh(\gamma_{mn}c) \\ &= \sum_{n=1}^{\infty} \sum_{m=1}^{\infty} B_{mn} \sin\left(\frac{n\pi}{a}x\right) \sin\left(\frac{m\pi}{b}y\right), \end{aligned}$$

where $B_{mn} \equiv A_{mn} \sinh(\gamma_{mn}c)$. This is a two-dimensional Fourier series (see Chap. 9) whose coefficients are given by

$$B_{mn} = \frac{4}{ab} \int_0^a dx \int_0^b dy f(x, y) \sin\left(\frac{n\pi}{a}x\right) \sin\left(\frac{m\pi}{b}y\right).$$

Historical Notes

Pierre Simon de Laplace (1749–1827) was a French mathematician and theoretical astronomer who was so famous in his own time that he was known as the Newton of France. His main interests throughout his life were celestial mechanics, the theory of probability, and personal advancement.

At the age of 24 he was already deeply engaged in the detailed application of Newton's law of gravitation to the solar system as a whole, in which the planets and their satellites are not governed by the sun alone, but interact with one another in a bewildering variety of ways. Even Newton had been of the opinion that divine intervention would occasionally be needed to prevent this complex mechanism from degenerating into chaos. Laplace decided to seek reassurance elsewhere, and succeeded in proving that the ideal solar system of mathematics is a stable dynamical system that will endure unchanged for all time. This achievement was only one of the long series of triumphs recorded in his monumental treatise *Mécanique Céleste* (published in five volumes from 1799 to 1825), which summed up the work on gravitation of several generations of illustrious mathematicians. Unfortunately for his later reputation, he omitted all reference to the discoveries of his predecessors and contemporaries, and left it to be inferred that the ideas were entirely his own. Many anecdotes are associated with this work. One of the best known describes the occasion on which Napoleon tried to get a rise out of Laplace by protesting that he had written a huge book on the system of the world without once mentioning God as the author of the universe. Laplace is supposed to have replied, "Sire, I had no need of that hypothesis." The principal legacy of the *Mécanique Céleste* to later generations lay in Laplace's wholesale development of potential theory, with its far-reaching implications for a dozen different branches of physical science ranging from gravitation and fluid mechanics to electromagnetism and atomic physics. Even though he lifted the idea of the potential from Lagrange without acknowledgment, he exploited it so extensively that ever since his time the fundamental equation of potential theory has been known as Laplace's equation. After the French Revolution, Laplace's political talents and greed for position came to full flower. His compatriots speak ironically of his "suppleness" and "versatility" as a politician. What this really means is that each time there was a change of regime (and there were many), Laplace smoothly adapted himself by changing his principles—back and forth between fervent republicanism and fawning royalism—and each time he emerged with a better job and grander titles. He has been aptly compared with the apocryphal Vicar of Bray in English literature, who was twice a Catholic and twice a Protestant. The Vicar is said to have replied as follows to the charge of being a turncoat: "Not so, neither, for if I changed my religion, I am sure I kept true to my principle, which is to live and die the Vicar of Bray."

To balance his faults, Laplace was always generous in giving assistance and encouragement to younger scientists. From time to time he helped forward in their careers such men as the chemist Gay-Lussac, the traveler and naturalist Humboldt, the physicist Poisson, and—appropriately—the young Cauchy, who was destined to become one of the chief architects of nineteenth century mathematics.



Pierre Simon de Laplace
1749–1827

19.5.2 Heat Conduction in a Rectangular Plate

Consider a rectangular heat-conducting plate with sides of length a and b all held at $T = 0$. Assume that at time $t = 0$ the temperature has a distribution function $f(x, y)$. Let us find the variation of temperature for all points (x, y) at all times $t > 0$.

The diffusion equation for this problem is

$$\frac{\partial T}{\partial t} = k^2 \nabla^2 T = k^2 \left(\frac{\partial^2 T}{\partial x^2} + \frac{\partial^2 T}{\partial y^2} \right).$$

A separation of variables, $T(x, y, t) = X(x)Y(y)g(t)$, leads to three DEs:

$$\frac{d^2 X}{dx^2} + \lambda X = 0, \quad \frac{d^2 Y}{dy^2} + \mu Y = 0, \quad \frac{dg}{dt} + k^2(\lambda + \mu)g = 0.$$

The BCs $T(0, y, t) = T(a, y, t) = T(x, 0, t) = T(x, b, t) = 0$, together with the three ODEs, give rise to two S-L systems. The solutions to both of these are easily found:

$$\lambda_n = \left(\frac{n\pi}{a} \right)^2 \quad \text{and} \quad X_n(x) = \sin\left(\frac{n\pi}{a} x \right) \quad \text{for } n = 1, 2, \dots,$$

$$\mu_m = \left(\frac{m\pi}{b} \right)^2 \quad \text{and} \quad Y_m(y) = \sin\left(\frac{m\pi}{b} y \right) \quad \text{for } m = 1, 2, \dots$$

These give rise to the general solutions

$$X(x) = \sum_{n=1}^{\infty} A_n \sin\left(\frac{n\pi}{a} x \right), \quad Y(y) = \sum_{m=1}^{\infty} B_m \sin\left(\frac{m\pi}{b} y \right).$$

With $\gamma_{mn} \equiv k^2 \pi^2 (n^2/a^2 + m^2/b^2)$, the solution to the g equation can be expressed as $g(t) = C_{mn} e^{-\gamma_{mn} t}$. Putting everything together, we obtain

$$T(x, y, t) = \sum_{n=1}^{\infty} \sum_{m=1}^{\infty} A_{mn} e^{-\gamma_{mn} t} \sin\left(\frac{n\pi}{a} x \right) \sin\left(\frac{m\pi}{b} y \right),$$

where $A_{mn} = A_n B_m C_{mn}$ is an arbitrary constant. To determine it, we impose the initial condition $T(x, y, 0) = f(x, y)$. This yields

$$f(x, y) = \sum_{n=1}^{\infty} \sum_{m=1}^{\infty} A_{mn} \sin\left(\frac{n\pi}{a} x \right) \sin\left(\frac{m\pi}{b} y \right),$$

which determines the coefficients A_{mn} :

$$A_{mn} = \frac{4}{ab} \int_0^a dx \int_0^b dy f(x, y) \sin\left(\frac{n\pi}{a} x \right) \sin\left(\frac{m\pi}{b} y \right).$$

19.5.3 Quantum Particle in a Box

The behavior of an atomic particle of mass μ confined in a rectangular box with sides a , b , and c (an infinite three-dimensional potential well) is governed by the Schrödinger equation for a free particle,

$$i\hbar \frac{\partial \psi}{\partial t} = -\frac{\hbar^2}{2\mu} \left(\frac{\partial^2 \psi}{\partial x^2} + \frac{\partial^2 \psi}{\partial y^2} + \frac{\partial^2 \psi}{\partial z^2} \right),$$

and the BC that $\psi(x, y, z, t)$ vanishes at all sides of the box for all time.

A separation of variables $\psi(x, y, z, t) = X(x)Y(y)Z(z)T(t)$ yields the ODEs

$$\begin{aligned} \frac{d^2X}{dx^2} + \lambda X &= 0, & \frac{d^2Y}{dy^2} + \sigma Y &= 0, & \frac{d^2Z}{dz^2} + \nu Z &= 0, \\ \frac{dT}{dt} + i\omega T &= 0, & \text{where } \omega &\equiv \frac{\hbar}{2\mu}(\lambda + \sigma + \nu). \end{aligned}$$

The spatial equations, together with the BCs

$$\begin{aligned} \psi(0, y, z, t) = \psi(a, y, z, t) = 0 &\Rightarrow X(0) = 0 = X(a), \\ \psi(x, 0, z, t) = \psi(x, b, z, t) = 0 &\Rightarrow Y(0) = 0 = Y(b), \\ \psi(x, y, 0, t) = \psi(x, y, c, t) = 0 &\Rightarrow Z(0) = 0 = Z(c), \end{aligned}$$

lead to three S-L systems, whose solutions are easily found:

$$\begin{aligned} X_n(x) &= \sin\left(\frac{n\pi}{a}x\right), & \lambda_n &= \left(\frac{n\pi}{a}\right)^2, & \text{for } n &= 1, 2, \dots, \\ Y_m(y) &= \sin\left(\frac{m\pi}{b}y\right), & \sigma_m &= \left(\frac{m\pi}{b}\right)^2, & \text{for } m &= 1, 2, \dots, \\ Z_l(z) &= \sin\left(\frac{l\pi}{c}z\right), & \nu_l &= \left(\frac{l\pi}{c}\right)^2, & \text{for } l &= 1, 2, \dots \end{aligned}$$

The time equation, on the other hand, has a solution of the form

$$\begin{aligned} T(t) &= C_{lmn} e^{-i\omega_{lmn}t} \quad \text{where} \\ \omega_{lmn} &= \frac{\hbar}{2\mu} \left[\left(\frac{n\pi}{a}\right)^2 + \left(\frac{m\pi}{b}\right)^2 + \left(\frac{l\pi}{c}\right)^2 \right]. \end{aligned}$$

The solution of the Schrödinger equation that is consistent with the BCs is therefore

$$\psi(x, y, z, t) = \sum_{l,m,n=1}^{\infty} A_{lmn} e^{-i\omega_{lmn}t} \sin\left(\frac{n\pi}{a}x\right) \sin\left(\frac{m\pi}{b}y\right) \sin\left(\frac{l\pi}{c}z\right).$$

The constants A_{lmn} are determined by the initial shape, $\psi(x, y, z, 0)$ of the wave function. The energy of the particle is

$$E = \hbar\omega_{lmn} = \frac{\hbar^2\pi^2}{2\mu} \left(\frac{n^2}{a^2} + \frac{m^2}{b^2} + \frac{l^2}{c^2} \right).$$

Each set of three positive integers (n, m, l) represents a state of the particle. For a cube, $a = b = c \equiv L$, and the energy of the particle is

$$E = \frac{\hbar^2\pi^2}{2\mu L^2} (n^2 + m^2 + l^2) = \frac{\hbar^2\pi^2}{2\mu V^{2/3}} (n^2 + m^2 + l^2) \quad (19.28)$$

where $V = L^3$ is the volume of the box. The ground state is $(1, 1, 1)$, has energy $E = 3\hbar^2\pi^2/2\mu V^{2/3}$, and is nondegenerate (only one state corresponds to this energy). However, the higher-level states are degenerate. For instance, the three distinct states $(1, 1, 2)$, $(1, 2, 1)$, and $(2, 1, 1)$ all correspond to the same energy, $E = 6\hbar^2\pi^2/2\mu V^{2/3}$. The degeneracy increases rapidly with larger values of n , m , and l .

Equation (19.28) can be written as

$$n^2 + m^2 + l^2 = R^2, \quad \text{where } R^2 = \frac{2\mu EV^{2/3}}{\hbar^2\pi^2}.$$

This looks like the equation of a sphere in the nml -space. If R is large, the number of states contained within the sphere of radius R (the number of states with energy less than or equal to E) is simply the volume of the first octant⁸ of the sphere. If N is the number of such states, we have

$$N = \frac{1}{8} \left(\frac{4\pi}{3} \right) R^3 = \frac{\pi}{6} \left(\frac{2\mu EV^{2/3}}{\hbar^2\pi^2} \right)^{3/2} = \frac{\pi}{6} \left(\frac{2\mu E}{\hbar^2\pi^2} \right)^{3/2} V.$$

density of states Thus the **density of states** (the number of states per unit volume) is

$$n = \frac{N}{V} = \frac{\pi}{6} \left(\frac{2\mu}{\hbar^2\pi^2} \right)^{3/2} E^{3/2}. \quad (19.29)$$

Fermi energy This is an important formula in solid-state physics, because the energy E is (with minor modifications required by spin) the **Fermi energy**. If the Fermi energy is denoted by E_f , Eq. (19.29) gives $E_f = \alpha n^{2/3}$, where α is some constant.

19.5.4 Wave Guides

In the preceding examples the time variation is given by a first derivative. Thus, as far as time is concerned, we have a FODE. It follows that the initial specification of the physical quantity of interest (temperature T or Schrödinger wave function ψ) is sufficient to determine the solution uniquely.

A second kind of time-dependent PDE occurring in physics is the wave equation, which contains time derivatives of the second order. Thus, there are two arbitrary parameters in the general solution. To determine these, we expect two initial conditions. For example, if the wave is standing, as in a rope clamped at both ends, the boundary conditions are not sufficient to determine the wave function uniquely. One also needs to specify the initial (transverse) velocity of each point of the rope.

For traveling waves, specification of the wave shape and velocity shape is not as important as the mode of propagation. For instance, in the theory of wave guides, after the time variation is separated, a particular time variation,

⁸This is because n , m , and l are all positive.

such as $e^{+i\omega t}$, and a particular direction for the propagation of the wave, say the z -axis, are chosen. Thus, if u denotes a component of the electric or the magnetic field, we can write

$$u(x, y, z, t) = \psi(x, y)e^{i(\omega t \pm kz)},$$

where k is the wave number. The wave equation then reduces to

$$\frac{\partial^2 \psi}{\partial x^2} + \frac{\partial^2 \psi}{\partial y^2} + \left(\frac{\omega^2}{c^2} - k^2 \right) \psi = 0.$$

Introducing $\gamma^2 = \omega^2/c^2 - k^2$ and the transverse gradient $\nabla_t = (\partial/\partial x, \partial/\partial y)$ and writing the above equation in terms of the full vectors, we obtain

$$(\nabla_t^2 + \gamma^2) \begin{Bmatrix} \mathbf{E} \\ \mathbf{B} \end{Bmatrix} = 0, \quad \text{where} \quad \begin{Bmatrix} \mathbf{E} \\ \mathbf{B} \end{Bmatrix} = \begin{Bmatrix} \mathbf{E}(x, y) \\ \mathbf{B}(x, y) \end{Bmatrix} e^{i(\omega t \pm kz)}. \quad (19.30)$$

These are the basic equations used in the study of electromagnetic wave guides and resonant cavities.

Maxwell's equations in conjunction with Eq. (19.30) gives the transverse components (components perpendicular to the propagation direction) \mathbf{E}_t and \mathbf{B}_t in terms of the longitudinal components E_z and B_z (see [Lorr 88, Chap. 33]): guided waves

$$\begin{aligned} \gamma^2 \mathbf{E}_t &= \nabla_t \left(\frac{\partial E_z}{\partial z} \right) - i \frac{\omega}{c} \hat{\mathbf{e}}_z \times (\nabla_t B_z), \\ \gamma^2 \mathbf{B}_t &= \nabla_t \left(\frac{\partial B_z}{\partial z} \right) + i \frac{\omega}{c} \hat{\mathbf{e}}_z \times (\nabla_t E_z). \end{aligned} \quad (19.31)$$

Three types of guided waves are usually studied.

1. Transverse magnetic (TM) waves have $B_z = 0$ everywhere. The BC on \mathbf{E} demands that E_z vanish at the conducting walls of the guide.
2. Transverse electric (TE) waves have $E_z = 0$ everywhere. The BC on \mathbf{B} requires that the normal directional derivative

$$\frac{\partial B_z}{\partial n} \equiv \hat{\mathbf{e}}_n \cdot (\nabla B_z)$$

vanish at the walls.

3. Transverse electromagnetic (TEM) waves have $B_z = 0 = E_z$. For a nontrivial solution, Eq. (19.31) demands that $\gamma^2 = 0$. This form resembles a free wave with no boundaries.

We quote the basic equations for the TM mode (see any book on electromagnetic theory for further details):

$$\begin{aligned} (\nabla_t^2 + \gamma^2) E_z &= 0, & B_z &= 0, \\ \gamma^2 \mathbf{E}_t &= \nabla_t \left(\frac{\partial E_z}{\partial z} \right), & \gamma^2 \mathbf{B}_t &= i \frac{\omega}{c} \hat{\mathbf{e}}_z \times (\nabla_t E_z), \end{aligned} \quad (19.32)$$

where ∇_t^2 is restricted to the x and y terms of the Laplacian in Cartesian coordinates, and to the ρ and φ terms in cylindrical coordinates.

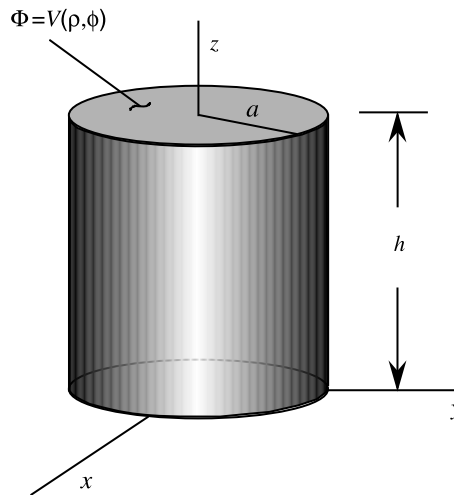

Fig. 19.2 A conducting cylindrical can whose top has a potential given by $V(\rho, \phi)$, with the rest of the surface grounded

19.6 Separation in Cylindrical Coordinates

When the geometry of the boundaries is cylindrical, the appropriate coordinate system is the cylindrical one. This usually leads to Bessel functions “of some kind.”

Before working specific examples of cylindrical geometry, let us consider a question that has more general implications. We saw in the previous section that separation of variables leads to ODEs in which certain constants (eigenvalues) appear. Different choices of signs for these constants can lead to different functional forms of the general solution. For example, an equation such as $d^2x/dt^2 - kx = 0$ can have exponential solutions if $k > 0$ or trigonometric solutions if $k < 0$. One cannot *a priori* assign a specific sign to k . Thus, the *general* form of the solution is indeterminate. However, once the boundary conditions are imposed, the unique solutions will emerge regardless of the initial functional form of the solutions (see [Hass 08] for a thorough discussion of this point).

19.6.1 Conducting Cylindrical Can

Consider a cylindrical conducting can of radius a and height h (see Fig. 19.2). The potential varies at the top face as $V(\rho, \phi)$, while the lateral surface and the bottom face are grounded. Let us find the electrostatic potential at all points inside the can.

A separation of variables transforms Laplace’s equation into three ODEs:

$$\frac{d}{d\rho} \left(\rho \frac{dR}{d\rho} \right) + \left(k^2 \rho - \frac{m^2}{\rho} \right) R = 0,$$

$$\frac{d^2 S}{d\phi^2} + m^2 S = 0, \quad \frac{d^2 Z}{dz^2} - k^2 Z = 0,$$

where in anticipation of the correct BCs, we have written the constants as k^2 and $-m^2$ with m an integer. The first of these is the Bessel equation, whose general solution can be written as $R(\rho) = AJ_m(k\rho) + BY_m(k\rho)$. The second DE, when the extra condition of periodicity in φ is imposed on the potential, has the general solution

$$S(\varphi) = C \cos m\varphi + D \sin m\varphi.$$

Finally the third DE has a general solution of the form

$$Z(z) = Ee^{kz} + Fe^{-kz}.$$

We note that none of the three ODEs lead to an S-L system of Theorem 19.4.1 because the BCs associated with them do not satisfy (19.24). However, we can still solve the problem by imposing the given BCs.

The fact that the potential must be finite everywhere inside the can (including at $\rho = 0$) forces B to vanish because the Neumann function $Y_m(k\rho)$ is not defined at $\rho = 0$. On the other hand, we want Φ to vanish at $\rho = a$. This gives $J_m(ka) = 0$, which demands that ka be a root of the Bessel function of order m . Denoting by x_{mn} the n th zero of the Bessel function of order m , we have $ka = x_{mn}$, or $k = x_{mn}/a$ for $n = 1, 2, \dots$

Similarly, the vanishing of Φ at $z = 0$ implies that

$$E = -F \quad \text{and} \quad Z(z) = E \sinh\left(\frac{x_{mn}z}{a}\right).$$

We can now multiply R , S , and Z and sum over all possible values of m and n , keeping in mind that negative values of m give terms that are linearly dependent on the corresponding positive values. The result is the so-called **Fourier-Bessel series**:

Fourier-Bessel series

$$\begin{aligned} \Phi(\rho, \varphi, z) = & \sum_{m=0}^{\infty} \sum_{n=1}^{\infty} J_m\left(\frac{x_{mn}}{a}\rho\right) \sinh\left(\frac{x_{mn}}{a}z\right) \\ & \times (A_{mn} \cos m\varphi + B_{mn} \sin m\varphi), \end{aligned} \quad (19.33)$$

where A_{mn} and B_{mn} are constants to be determined by the remaining BC. To find these constants we use the orthogonality of the trigonometric and Bessel functions. For $z = h$ Eq. (19.33) reduces to

$$V(\rho, \varphi) = \sum_{m=0}^{\infty} \sum_{n=1}^{\infty} J_m\left(\frac{x_{mn}}{a}\rho\right) \sinh\left(\frac{x_{mn}}{a}h\right) (A_{mn} \cos m\varphi + B_{mn} \sin m\varphi),$$

from which we obtain

$$\begin{aligned} A_{mn} = & \frac{2}{\pi a^2 J_{m+1}^2(x_{mn}) \sinh(x_{mn}h/a)} \\ & \times \int_0^{2\pi} d\varphi \int_0^a d\rho \rho V(\rho, \varphi) J_m\left(\frac{x_{mn}}{a}\rho\right) \cos m\varphi, \end{aligned}$$

$$B_{mn} = \frac{2}{\pi a^2 J_{m+1}^2(x_{mn}) \sinh(x_{mn}h/a)} \\ \times \int_0^{2\pi} d\varphi \int_0^a d\rho \rho V(\rho, \varphi) J_m\left(\frac{x_{mn}}{a}\rho\right) \sin m\varphi,$$

where we have used the following result derived in Problem 15.39:

$$\int_0^a \rho J_m^2\left(\frac{x_{mn}}{a}\rho\right) d\rho = \frac{a^2}{2} J_{m+1}^2(x_{mn}). \quad (19.34)$$

For the special but important case of azimuthal symmetry, for which V is independent of φ , we obtain

$$A_{mn} = \frac{4\delta_{m,0}}{a^2 J_1^2(x_{0n}) \sinh(x_{0n}h/a)} \int_0^a d\rho \rho V(\rho) J_0\left(\frac{x_{0n}}{a}\rho\right), \\ B_{mn} = 0,$$

and

$$\Phi(\rho, z) = \frac{4}{a^2} \sum_{n=1}^{\infty} A_n \frac{J_0\left(\frac{x_{0n}}{a}\rho\right) \sinh\left(\frac{x_{0n}}{a}z\right)}{J_1^2(x_{0n}) \sinh(x_{0n}h/a)},$$

where

$$A_n = \int_0^a d\rho \rho V(\rho) J_0\left(\frac{x_{0n}}{a}\rho\right),$$

and $V(\rho)$ is the φ -independent potential at the top face.

The reason we obtained discrete values for k was the demand that Φ vanish at $\rho = a$. If we let $a \rightarrow \infty$, then k will be a continuous variable, and instead of a sum over k , we will obtain an integral. This is completely analogous to the transition from a Fourier series to a Fourier transform, but we will not pursue it further.

19.6.2 Cylindrical Wave Guide

For a TM wave propagating along the z -axis in a hollow circular conductor, we have [see Eq. (19.32)]

$$\frac{1}{\rho} \frac{\partial}{\partial \rho} \left(\rho \frac{\partial E_z}{\partial \rho} \right) + \frac{1}{\rho^2} \frac{\partial^2 E_z}{\partial \varphi^2} + \gamma^2 E_z = 0.$$

The separation $E_z = R(\rho)S(\varphi)$ yields $S(\varphi) = A \cos m\varphi + B \sin m\varphi$ and

$$\frac{d^2 R}{d\rho^2} + \frac{1}{\rho} \frac{dR}{d\rho} + \left(\gamma^2 - \frac{m^2}{\rho^2} \right) R = 0.$$

The solution to this equation, which is regular at $\rho = 0$ and vanishes at $\rho = a$, is

$$R(\rho) = C J_m\left(\frac{x_{mn}}{a}\rho\right) \quad \text{and} \quad \gamma = \frac{x_{mn}}{a}.$$

Recalling the definition of γ , we obtain

$$\frac{\omega^2}{c^2} - k^2 = \gamma^2 = \frac{x_{mn}^2}{a^2} \Rightarrow k = \sqrt{\frac{\omega^2}{c^2} - \frac{x_{mn}^2}{a^2}}.$$

This gives the cut-off frequency $\omega_{mn} = cx_{mn}/a$.

The solution for the azimuthally symmetric case ($m = 0$) is

$$E_z(\rho, \varphi, t) = \sum_{n=1}^{\infty} A_n J_0\left(\frac{x_{0n}}{a} \rho\right) e^{i(\omega t \pm k_n z)} \quad \text{and} \quad B_z = 0,$$

where $k_n = \sqrt{\omega^2/c^2 - x_{0n}^2/a^2}$.

19.6.3 Current Distribution in a Circular Wire

There are many variations on the theme of Bessel functions. We have encountered three kinds of Bessel functions, as well as modified Bessel functions. Another variation encountered in applications leads to what are known as **Kelvin functions**, introduced here.

Consider the flow of charges in an infinitely long wire with a circular cross section of radius a . We are interested in calculating the variation of the current density in the wire as a function of time and location. The relevant equation can be obtained by starting with Maxwell's equations for negligible charge density ($\nabla \cdot \mathbf{E} = 0$), Ohm's law ($\mathbf{j} = \sigma \mathbf{E}$), the assumption of high electrical conductivity ($|\sigma \mathbf{E}| \gg |\partial \mathbf{E} / \partial t|$), and the usual procedure of obtaining the wave equation from Maxwell's equations. The result is

$$\nabla^2 \mathbf{j} - \frac{4\pi\sigma}{c^2} \frac{\partial \mathbf{j}}{\partial t} = 0.$$

Moreover, we make the simplifying assumptions that the wire is along the z -axis and that there is no turbulence, so \mathbf{j} is also along the z direction. We further assume that \mathbf{j} is independent of φ and z , and that its time-dependence is given by $e^{-i\omega t}$. Then we get

$$\frac{d^2 j}{d\rho^2} + \frac{1}{\rho} \frac{dj}{d\rho} + \tau^2 j = 0, \quad (19.35)$$

where $\tau^2 = i4\pi\sigma\omega/c^2 \equiv i2/\delta^2$ and $\delta = c/\sqrt{2\pi\sigma\omega}$ is called the **skin depth**.

The **Kelvin equation** is usually given as

$$\frac{d^2 w}{dx^2} + \frac{1}{x} \frac{dw}{dx} - ik^2 w = 0. \quad (19.36)$$

If we substitute $x = \sqrt{i}t/k$, it becomes $\ddot{w} + \dot{w}/t + w = 0$, which is a Bessel equation of order zero. If the solution is to be regular at $x = 0$, then the only choice is $w(t) = J_0(t) = J_0(e^{-i\pi/4} kx)$. This is the **Kelvin function**

skin depth
Kelvin equation

Kelvin function

for Eq. (19.36). It is usually written as

$$J_0(e^{-i\pi/4}kx) \equiv \text{ber}(kx) + i \text{bei}(kx)$$

where ber and bei stand for “Bessel real” and “Bessel imaginary”, respectively. If we substitute $z = e^{-i\pi/4}kx$ in the expansion for $J_0(z)$ and separate the real and the imaginary parts of the expansion, we obtain

$$\begin{aligned} \text{ber}(x) &= 1 - \frac{(x/2)^4}{(2!)^2} + \frac{(x/2)^8}{(4!)^2} - \dots \\ \text{bei}(x) &= \frac{(x/2)^2}{(1!)^2} - \frac{(x/2)^6}{(3!)^2} + \frac{(x/2)^{10}}{(5!)^2} - \dots \end{aligned}$$

Equation (19.35) is the complex conjugate of (19.36) with $k^2 = 2/\delta^2$. Thus, its solution is

$$j(\rho) = AJ_0(e^{i\pi/4}k\rho) = A \left\{ \text{ber}\left(\frac{\sqrt{2}}{\delta}\rho\right) - i \text{bei}\left(\frac{\sqrt{2}}{\delta}\rho\right) \right\}.$$

We can compare the value of the current density at ρ with its value at the surface $\rho = a$:

$$\left| \frac{j(\rho)}{j(a)} \right| = \left[\frac{\text{ber}^2(\frac{\sqrt{2}}{\delta}\rho) + \text{bei}^2(\frac{\sqrt{2}}{\delta}\rho)}{\text{ber}^2(\frac{\sqrt{2}}{\delta}a) + \text{bei}^2(\frac{\sqrt{2}}{\delta}a)} \right]^{1/2}.$$

For low frequencies, δ is large, which implies that ρ/δ is small; thus, $\text{ber}(\sqrt{2}\rho/\delta) \approx 1$ and $\text{bei}(\sqrt{2}\rho/\delta) \approx 0$, and $|j(\rho)/j(a)| \approx 1$; i.e., the current density is almost uniform. For higher frequencies the ratio of the current densities starts at a value less than 1 at $\rho = 0$ and increases to 1 at $\rho = a$. The starting value depends on the frequency. For very large frequencies the starting value is almost zero (see [Mari 80, pp 150–156]).

19.7 Separation in Spherical Coordinates

Recall that most PDEs encountered in physical applications can be separated, in spherical coordinates, into

$$\begin{aligned} \mathbf{L}^2 Y(\theta, \varphi) &= l(l+1)Y(\theta, \varphi), \\ \frac{d^2 R}{dr^2} + \frac{2}{r} \frac{dR}{dr} + \left[f(r) - \frac{l(l+1)}{r^2} \right] R &= 0. \end{aligned} \tag{19.37}$$

We discussed the first of these two equations in great detail in Chap. 13. In particular, we constructed $Y_{lm}(\theta, \varphi)$ in such a way that they formed an orthonormal sequence. However, that construction was purely algebraic and did not say anything about the completeness of $Y_{lm}(\theta, \varphi)$. With Theorem 19.4.1 at our disposal, we can separate the first equation of (19.37) into

two ODEs by writing $Y_{lm}(\theta, \varphi) = P_{lm}(\theta)S_m(\varphi)$. We obtain

$$\frac{d^2 S_m}{d\varphi^2} + m^2 S_m = 0,$$

$$\frac{d}{dx} \left[(1-x^2) \frac{dP_{lm}}{dx} \right] + \left[l(l+1) - \frac{m^2}{1-x^2} \right] P_{lm} = 0,$$

where $x = \cos\theta$. These are both S-L systems satisfying the conditions of Theorem 19.4.1. Thus, the S_m are orthogonal among themselves and form a complete set for $\mathcal{L}^2(0, 2\pi)$. Similarly, for any fixed m , the $P_{lm}(x)$ form a complete orthogonal set for $\mathcal{L}^2(-1, +1)$ (actually for the subset of $\mathcal{L}^2(-1, +1)$ that satisfies the same BC as the P_{lm} do at $x = \pm 1$). Thus, the products $Y_{lm}(x, \varphi) = P_{lm}(x)S_m(\varphi)$ form a complete orthogonal sequence in the (Cartesian product) set $[-1, +1] \times [0, 2\pi]$, which, in terms of spherical angles, is the unit sphere, $0 \leq \theta \leq \pi$, $0 \leq \varphi \leq 2\pi$.

19.7.1 Radial Part of Laplace's Equation

Let us consider some specific examples of expansion in the spherical coordinate system starting with the simplest case, Laplace's equation for which $f(r) = 0$. The radial equation is therefore

$$\frac{d^2 R}{dr^2} + \frac{2}{r} \frac{dR}{dr} - \frac{l(l+1)}{r^2} R = 0.$$

Multiplying by r^2 , substituting $r = e^t$, and using the chain rule and the fact that $dt/dr = 1/r$ leads to the following SOLDE with constant coefficients:

$$\frac{d^2 R}{dt^2} + \frac{dR}{dt} - l(l+1)R = 0.$$

This has a characteristic polynomial $p(\lambda) = \lambda^2 + \lambda - l(l+1)$ with roots $\lambda_1 = l$ and $\lambda_2 = -(l+1)$. Thus, a general solution is of the form

$$R(t) = Ae^{\lambda_1 t} + Be^{\lambda_2 t} = A(e^t)^l + B(e^t)^{-l-1},$$

or, in terms of r , $R(r) = Ar^l + Br^{-l-1}$. Thus, the most general solution of Laplace's equation is

$$\Phi(r, \theta, \varphi) = \sum_{l=0}^{\infty} \sum_{m=-l}^l (A_{lm}r^l + B_{lm}r^{-l-1})Y_{lm}(\theta, \varphi).$$

For regions containing the origin, the finiteness of Φ implies that $B_{lm} = 0$. Denoting the potential in such regions by Φ_{in} , we obtain

$$\Phi_{\text{in}}(r, \theta, \varphi) = \sum_{l=0}^{\infty} \sum_{m=-l}^l A_{lm}r^l Y_{lm}(\theta, \varphi).$$

Similarly, for regions including $r = \infty$, we have

$$\Phi_{\text{out}}(r, \theta, \varphi) = \sum_{l=0}^{\infty} \sum_{m=-l}^l B_{lm} r^{-l-1} Y_{lm}(\theta, \varphi).$$

To determine A_{lm} and B_{lm} , we need to invoke appropriate BCs. In particular, for inside a sphere of radius a on which the potential is given by $V(\theta, \varphi)$, we have

$$V(\theta, \varphi) = \Phi_{\text{in}}(a, \theta, \varphi) = \sum_{l=0}^{\infty} \sum_{m=-l}^l A_{lm} a^l Y_{lm}(\theta, \varphi).$$

Multiplying by $Y_{kj}^*(\theta, \varphi)$ and integrating over $d\Omega = \sin\theta d\theta d\varphi$, we obtain

$$\begin{aligned} A_{kj} &= a^{-k} \iint d\Omega V(\theta, \varphi) Y_{kj}^*(\theta, \varphi) \\ \Rightarrow A_{lm} &= a^{-l} \iint d\Omega V(\theta, \varphi) Y_{lm}^*(\theta, \varphi). \end{aligned}$$

Similarly, for potential outside the sphere,

$$B_{lm} = a^{l+1} \iint d\Omega V(\theta, \varphi) Y_{lm}^*(\theta, \varphi).$$

In particular, if V is independent of φ , only the components for which $m = 0$ are nonzero, and we have

$$\begin{aligned} A_{l0} &= \frac{2\pi}{a^l} \int_0^\pi \sin\theta V(\theta) Y_{l0}^*(\theta) d\theta \\ &= \frac{2\pi}{a^l} \sqrt{\frac{2l+1}{4\pi}} \int_0^\pi \sin\theta V(\theta) P_l(\cos\theta) d\theta, \end{aligned}$$

which yields

$$\Phi_{\text{in}}(r, \theta) = \sum_{l=0}^{\infty} A_l \left(\frac{r}{a}\right)^l P_l(\cos\theta),$$

where

$$A_l = \frac{2}{2l+1} \int_0^\pi \sin\theta V(\theta) P_l(\cos\theta) d\theta.$$

Similarly,

$$\Phi_{\text{out}}(r, \theta) = \sum_{l=0}^{\infty} A_l \left(\frac{a}{r}\right)^{l+1} P_l(\cos\theta).$$

19.7.2 Helmholtz Equation in Spherical Coordinates

The next simplest case after Laplace's equation is that for which $f(r)$ is a constant. The diffusion equation, the wave equation, and the Schrödinger equation for a free particle give rise to such a case once time is separated from the rest of the variables.

The **Helmholtz equation** is

Helmholtz equation

$$\nabla^2 \psi + k^2 \psi = 0, \quad (19.38)$$

and its radial part is

$$\frac{d^2 R}{dr^2} + \frac{2}{r} \frac{dR}{dr} + \left[k^2 - \frac{l(l+1)}{r^2} \right] R = 0. \quad (19.39)$$

(This equation was discussed in Problems 15.26 and 15.35.) The solutions are **spherical Bessel functions**, generically denoted by the corresponding lower case letter as $z_l(x)$ and given by

spherical Bessel functions

$$z_l(x) \equiv \sqrt{\frac{\pi}{2}} \frac{Z_{l+1/2}(x)}{\sqrt{x}}, \quad (19.40)$$

where $Z_\nu(x)$ is a solution of the Bessel equation of order ν .

A general solution of (19.39) can therefore be written as

$$R_l(r) = A j_l(kr) + B y_l(kr). \quad (19.41)$$

If the origin is included in the region of interest, then we must set $B = 0$. For such a case, the solution to the Helmholtz equation is

$$\psi_k(r, \theta, \varphi) = \sum_{l=0}^{\infty} \sum_{m=-l}^l A_{lm} j_l(kr) Y_{lm}(\theta, \varphi). \quad (19.42)$$

The subscript k indicates that ψ is a solution of the Helmholtz equation with k^2 as its constant.

19.7.3 Quantum Particle in a Hard Sphere

The time-independent Schrödinger equation for a particle in a sphere of radius a is $-\frac{\hbar^2}{2\mu} \nabla^2 \psi = E \psi$ with the BC $\psi(a, \theta, \varphi) = 0$. Here E is the energy of the particle and μ is its mass. We rewrite the Schrödinger equation as $\nabla^2 \psi + k^2 \psi = 0$ with $k^2 = 2\mu E / \hbar^2$. Then Eq. (19.41) and the fact that $R_l(r)$ must be finite at $r = 0$ yield

$$R_l(r) = A j_l(kr) = A j_l(\sqrt{2\mu E} r / \hbar).$$

The vanishing of ψ at a implies that $j_l(\sqrt{2\mu E} a / \hbar) = 0$, or

$$\frac{\sqrt{2\mu E} a}{\hbar} = X_{ln} \quad \text{for } n = 1, 2, \dots,$$

where X_{ln} is the n th zero of $j_l(x)$, which is the same as the zero of $J_{l+1/2}(x)$. Thus, the energy is quantized as

$$E_{ln} = \frac{\hbar^2 X_{ln}^2}{2\mu a^2} \quad \text{for } l = 0, 1, \dots, n = 1, 2, \dots$$

The general solution to the Schrödinger equation is

$$\psi(r, \theta, \varphi) = \sum_{n=1}^{\infty} \sum_{l=0}^{\infty} \sum_{m=-l}^l A_{nlm} j_l\left(X_{ln} \frac{r}{a}\right) Y_{lm}(\theta, \varphi).$$

19.7.4 Plane Wave Expansion

A particularly useful consequence of Eq. (19.42) is the expansion of a plane wave in terms of spherical Bessel functions. It is easily verified that if \mathbf{k} is a vector, with $\mathbf{k} \cdot \mathbf{k} = k^2$, then $e^{i\mathbf{k} \cdot \mathbf{r}}$ is a solution of the Helmholtz equation. Thus, $e^{i\mathbf{k} \cdot \mathbf{r}}$ can be expanded as in Eq. (19.42). Assuming that \mathbf{k} is along the z -axis, we get $\mathbf{k} \cdot \mathbf{r} = kr \cos \theta$, which is independent of φ . Only the terms of Eq. (19.42) for which $m = 0$ will survive in such a case, and we may write

$$e^{ikr \cos \theta} = \sum_{l=0}^{\infty} A_l j_l(kr) P_l(\cos \theta).$$

To find A_l , let $u = \cos \theta$, multiply both sides by $P_n(u)$, and integrate from -1 to 1 :

$$\int_{-1}^1 P_n(u) e^{ikru} du = \sum_{l=0}^{\infty} A_l j_l(kr) \int_{-1}^1 P_n(u) P_l(u) du = A_n j_n(kr) \frac{2}{2n+1}.$$

Thus

$$\begin{aligned} A_n j_n(kr) &= \frac{2n+1}{2} \int_{-1}^1 P_n(u) e^{ikru} du \\ &= \frac{2n+1}{2} \sum_{m=0}^{\infty} \frac{(ikr)^m}{m!} \int_{-1}^1 P_n(u) u^m du. \end{aligned} \quad (19.43)$$

This equality holds for all values of kr . In particular, both sides should give the same result in the limit of small kr . From the definition of $j_n(kr)$ and the expansion of $J_n(kr)$, we obtain

$$j_n(kr) \xrightarrow{kr \rightarrow 0} \frac{\sqrt{\pi}}{2} \left(\frac{kr}{2}\right)^n \frac{1}{\Gamma(n+3/2)}.$$

On the other hand, the first nonvanishing term of the RHS of Eq. (19.43) occurs when $m = n$. Equating these terms on both sides, we get

expansion of $e^{i\mathbf{k} \cdot \mathbf{r}}$ in spherical harmonics

$$A_n \frac{\sqrt{\pi}}{2} \left(\frac{kr}{2}\right)^n \frac{2^{2n+1} n!}{(2n+1)! \sqrt{\pi}} = \frac{2n+1}{2} \frac{i^n (kr)^n}{n!} \frac{2^{n+1} (n!)^2}{(2n+1)!}, \quad (19.44)$$

where we have used

$$\Gamma\left(n + \frac{3}{2}\right) = \frac{(2n+1)!\sqrt{\pi}}{2^{2n+1}n!} \quad \text{and} \quad \int_{-1}^1 P_n(u)u^n du = \frac{2^{n+1}(n!)^2}{(2n+1)!}.$$

Equation (19.44) yields $A_n = i^n(2n+1)$.

With A_n thus calculated, we can now write

$$e^{ikr \cos \theta} = \sum_{l=0}^{\infty} (2l+1)i^l j_l(kr) P_l(\cos \theta). \quad (19.45)$$

For an arbitrary direction of \mathbf{k} , $\mathbf{k} \cdot \mathbf{r} = kr \cos \gamma$, where γ is the angle between \mathbf{k} and \mathbf{r} . Thus, we may write

$$e^{i\mathbf{k} \cdot \mathbf{r}} = \sum_{l=0}^{\infty} (2l+1)i^l j_l(kr) P_l(\cos \gamma),$$

and using the addition theorem for spherical harmonics [Eq. (13.44)], we finally obtain

$$e^{i\mathbf{k} \cdot \mathbf{r}} = 4\pi \sum_{l=0}^{\infty} \sum_{m=-l}^l i^l j_l(kr) Y_{lm}^*(\theta', \varphi') Y_{lm}(\theta, \varphi), \quad (19.46)$$

where θ' and φ' are the spherical angles of \mathbf{k} and θ and φ are those of \mathbf{r} . Such a decomposition of plane waves into components with definite orbital angular momenta is extremely useful when working with scattering theory for waves and particles.

19.8 Problems

19.1 Show that the Liouville substitution transforms regular S-L systems into regular S-L systems and separated and periodic BCs into separated and periodic BCs, respectively.

19.2 Let $u_1(x)$ and $u_2(x)$ be transformed, respectively into $v_1(t)$ and $v_2(t)$ by the Liouville substitution. Show that the inner product on $[a, b]$ with weight function $w(x)$ is transformed into the inner product on $[0, c]$ with unit weight, where $c = \int_a^b \sqrt{w/p} dx$.

19.3 Derive Eq. (19.17) from (19.15) using Prüfer substitution.

19.4 Consider the Bessel DE.

(a) Show that the Liouville substitution transforms the Bessel DE into

$$\frac{d^2v}{dt^2} + \left(k^2 - \frac{v^2 - 1/4}{t^2}\right)v = 0.$$

- (b) Find the equations obtained from the Prüfer substitution, and show that for large x these equations reduce to

$$\phi' = k \left(1 - \frac{a}{2k^2x^2} \right) + \frac{O(1)}{x^3}, \quad \frac{R'}{R} = \frac{O(1)}{x^3},$$

where $a = v^2 - \frac{1}{4}$.

- (c) Integrate these equations from x to $b > x$ and take the limit as $b \rightarrow \infty$ to get

$$\phi(x) = \phi_\infty + kx + \frac{a}{2kx} + \frac{O(1)}{x^2}, \quad R(x) = R_\infty + \frac{O(1)}{x^2},$$

where $\phi_\infty = \lim_{b \rightarrow \infty} (\phi(b) - kb)$ and $R_\infty = \lim_{b \rightarrow \infty} R(b)$.

- (d) Substitute these and the appropriate expression for $Q^{-1/4}$ in Eq. (19.16) and show that

$$v(x) = \frac{R_\infty}{\sqrt{k}} \cos \left(kx - kx_\infty + \frac{v^2 - 1/4}{2kx} \right) + \frac{O(1)}{x^2},$$

where $kx_\infty \equiv \pi/2 - \phi_\infty$.

- (e) Choose $R_\infty = \sqrt{2/\pi}$ for all solutions of the Bessel DE, and let

$$kx_\infty = \left(\nu + \frac{1}{2} \right) \frac{\pi}{2} \quad \text{and} \quad kx_\infty = \left(\nu + \frac{3}{2} \right) \frac{\pi}{2}$$

for the Bessel functions $J_\nu(x)$ and the Neumann functions $Y_\nu(x)$, respectively, and find the asymptotic behavior of these two functions.

19.5 Show that separated and periodic BCs are special cases of the equality in Eq. (19.26).

19.6 Derive Eq. (19.27).

19.7 A semi-infinite heat-conducting plate of width b is extended along the positive x -axis with one corner at $(0, 0)$ and the other at $(0, b)$. The side of width b is held at temperature $T = f(y)$, and the two long sides are held at $T = 0$. The two flat faces are insulated and the plate is in thermal equilibrium.

- (a) Find the temperature variation of the plate for all (x, y) .
 (b) Specialize to the case where the side of width b is held at constant temperature T_0 (see Fig. 19.3).

19.8 Repeat Problem 19.7 with the temperature of the short side held at each of the following:

- (a) $T = \begin{cases} 0 & \text{if } 0 < y < b/2, \\ T_0 & \text{if } b/2 < y < b. \end{cases}$ (b) $\frac{T_0}{b}y, \quad 0 \leq y \leq b.$
 (c) $T_0 \cos\left(\frac{\pi}{b}y\right), \quad 0 \leq y \leq b.$ (d) $T_0 \sin\left(\frac{\pi}{b}y\right), \quad 0 \leq y \leq b.$

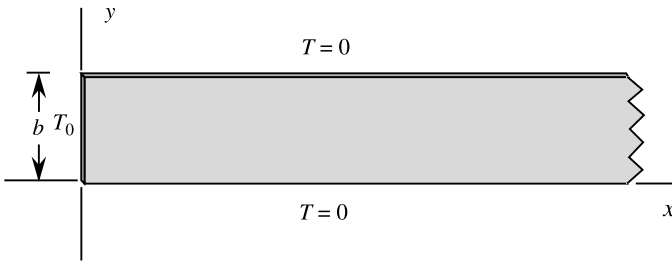

Fig. 19.3 A semi-infinite heat-conducting plate

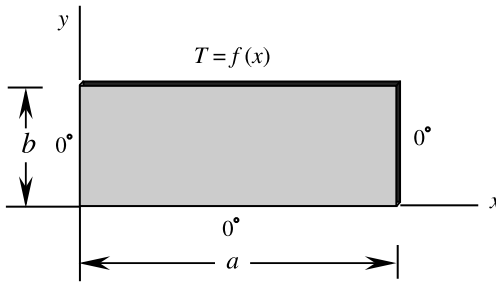

Fig. 19.4 A heat-conducting rectangular plate

19.9 Find a general solution for the electromagnetic wave propagation in a **resonant cavity**, a rectangular box of sides $0 \leq x \leq a$, $0 \leq y \leq b$, and $0 \leq z \leq d$ with perfectly conducting walls. Discuss the modes the cavity can accommodate.

19.10 The lateral faces of a cube are grounded, and its top and bottom faces are held at potentials $f_1(x, y)$ and $f_2(x, y)$, respectively.

- (a) Find a general expression for the potential inside the cube.
- (b) Find the potential if the top is held at V_0 volts and the bottom at $-V_0$ volts.

19.11 Find the potential inside a semi-infinite cylindrical conductor, closed at the nearby end, whose cross section is a square with sides of length a . All sides are grounded except the square side, which is held at the constant potential V_0 .

19.12 Consider a rectangular heat-conducting plate with sides of lengths a and b . Three of the sides are held at $T = 0$, and the fourth side has a temperature variation $T = f(x)$ (see Fig. 19.4). The flat faces are insulated, so they cannot lose heat to the surroundings. Assume a steady-state heat transfer.

- (a) Show that the separation of variables yields

$$X_n(x) = \sin\left(\frac{n\pi}{a}x\right), \quad Y(y) = \sinh\left(\frac{n\pi}{a}y\right) \quad \text{for } n = 1, 2, \dots$$

resonant cavity

heat-conducting plate:
steady state

(b) Show that the most general solution is

$$T(x, y) = X(x)Y(y) = \sum_{n=1}^{\infty} B_n \sin\left(\frac{n\pi}{a}x\right) \sinh\left(\frac{n\pi}{a}y\right)$$

with

$$B_n = \frac{2}{a \sinh(n\pi b/a)} \int_0^a \sin\left(\frac{n\pi}{a}x\right) f(x) dx.$$

(c) Show that if the fourth side is held at the constant temperature T_0 , then we obtain

$$T(x, y) = \frac{4T_0}{\pi} \sum_{k=0}^{\infty} \frac{1}{2k+1} \frac{\sin[(2k+1)\pi x/a] \sinh[(2k+1)\pi y/a]}{\sinh[(2k+1)\pi b/a]}.$$

(19.47)

(d) If the temperature variation of the fourth side is of the form $f(x) = T_0 \sin(\pi x/a)$, then

$$T(x, y) = T_0 \frac{\sin(\pi x/a) \sinh(\pi y/a)}{\sinh(\pi b/a)}.$$

(19.48)

19.13 Find the temperature distribution of a rectangular plate (see Fig. 19.4) with sides of lengths a and b if three sides are held at $T = 0$ and the fourth side has a temperature variation given by

$$\begin{aligned} \text{(a)} \quad & \frac{T_0}{a}x, \quad 0 \leq x < a. & \text{(b)} \quad & \frac{T_0}{a^2}x(x-a), \quad 0 \leq x \leq a. \\ \text{(c)} \quad & \frac{T_0}{a} \left| x - \frac{a}{2} \right|, \quad 0 \leq x < a. & \text{(d)} \quad & T = 0, \quad 0 \leq x \leq a. \end{aligned}$$

19.14 Consider a thin heat-conducting bar of length b along the x -axis with one end at $x = 0$ held at temperature T_0 and the other end at $x = b$ held at temperature $-T_0$. The lateral surface of the bar is thermally insulated. Find the temperature distribution at all times if initially it is given by

$$\begin{aligned} \text{(a)} \quad & T(0, x) = -\frac{2T_0}{b}x + T_0, \quad \text{where } 0 \leq x \leq b. \\ \text{(b)} \quad & T(0, x) = -\frac{2T_0}{b^2}x^2 + T_0, \quad \text{where } 0 \leq x \leq b. \\ \text{(c)} \quad & T(0, x) = \frac{T_0}{b}x + T_0, \quad \text{where } 0 \leq x < b. \\ \text{(d)} \quad & T(0, x) = T_0 \cos\left(\frac{\pi}{b}x\right), \quad \text{where } 0 \leq x \leq b. \end{aligned}$$

Hint: The solution corresponding to the zero eigenvalue is essential and cannot be excluded.

19.15 Determine $T(x, y, t)$ for the rectangular plate of Sect. 19.5.2 if initially the lower left quarter is held at T_0 and the rest of the plate is held at $T = 0$.

19.16 All sides of the plate of Sect. 19.5.2 are held at $T = 0$. Find the temperature distribution for all time if the initial temperature distribution is given by

$$(a) \quad T(x, y, 0) = \begin{cases} T_0 & \text{if } \frac{1}{4}a \leq x \leq \frac{3}{4}a \quad \text{and} \quad \frac{1}{4}b \leq y \leq \frac{3}{4}b, \\ 0 & \text{otherwise.} \end{cases}$$

$$(b) \quad T(x, y, 0) = \frac{T_0}{ab}xy, \quad \text{where } 0 \leq x < a \quad \text{and} \quad 0 \leq y < b.$$

$$(c) \quad T(x, y, 0) = \frac{T_0}{a}x, \quad \text{where } 0 \leq x < a \quad \text{and} \quad 0 < y < b.$$

19.17 Repeat the example of Sect. 19.5.2 with the temperatures of the sides equal to T_1, T_2, T_3 , and T_4 . Hint: You must include solutions corresponding to the zero eigenvalue.

19.18 A string of length a is fixed at the left end, and the right end moves with displacement $A \sin \omega t$. Find $\psi(x, t)$ and a consistent set of initial conditions for the displacement and the velocity.

19.19 Find the equation for a vibrating rectangular membrane with sides of lengths a and b rigidly fastened on all sides. For $a = b$, show that a given mode frequency may have more than one solution.

19.20 Repeat the example of Sect. 19.6.1 if the can has semi-infinite length, the lateral surface is grounded, and

- (a) the base is held at the potential $V(\rho, \varphi)$.
 (b) Specialize to the case where the potential of the base is given—in Cartesian coordinates—by

$$(i) \quad V = \frac{V_0}{a}y. \quad (ii) \quad V = \frac{V_0}{a}x. \quad (iii) \quad V = \frac{V_0}{a^2}xy.$$

Hint: Use the integral identity $\int z^{\nu+1} J_\nu(z) dz = z^{\nu+1} J_{\nu+1}(z)$.

19.21 Find the steady-state temperature distribution $T(\rho, \varphi, z)$ in a semi-infinite solid cylinder of radius a if the temperature distribution of the base is $f(\rho, \varphi)$ and the lateral surface is held at $T = 0$.

19.22 Find the steady-state temperature distribution of a solid cylinder with a height and radius of a , assuming that the base and the lateral surface are at $T = 0$ and the top is at T_0 .

19.23 The circumference of a flat circular plate of radius a , lying in the xy -plane, is held at $T = 0$. Find the temperature distribution for all time if the temperature distribution at $t = 0$ is given—in Cartesian coordinates—by

$$(a) \quad \frac{T_0}{a}y. \quad (b) \quad \frac{T_0}{a}x. \quad (c) \quad \frac{T_0}{a^2}xy. \quad (d) \quad T_0.$$

19.24 Find the temperature of a circular conducting plate of radius a at all points of its surface for all time $t > 0$, assuming that its edge is held at $T = 0$ and initially its surface from the center to $a/2$ is in contact with a heat bath of temperature T_0 .

19.25 Find the potential of a cylindrical conducting can of radius a and height h whose top is held at a constant potential V_0 while the rest is grounded.

19.26 Consider a wave guide with a rectangular cross section of sides a and b in the x and the y directions, respectively.

(a) Show that the separated DEs have the following solutions:

$$X_n(x) = \sin\left(\frac{n\pi}{a}x\right), \quad \lambda_n = \left(\frac{n\pi}{a}\right)^2 \quad \text{for } n = 1, 2, \dots,$$

$$Y_m(y) = \sin\left(\frac{m\pi}{b}y\right), \quad \mu_m = \left(\frac{m\pi}{b}\right)^2 \quad \text{for } m = 1, 2, \dots,$$

with $\gamma_{mn}^2 = \lambda_n + \mu_m$.

(b) Using the fact that the wave number must be real, show that there is a cutoff frequency given by

$$\omega_{mn} = c\sqrt{\left(\frac{n\pi}{a}\right)^2 + \left(\frac{m\pi}{b}\right)^2} \quad \text{for } m, n \geq 1.$$

(c) Show that the most general solution for E_z is therefore

$$E_z = \sum_{m,n=1}^{\infty} A_{mn} \sin\left(\frac{n\pi}{a}x\right) \sin\left(\frac{m\pi}{b}y\right) e^{i(\omega t \pm k_{mn}z)}.$$

circular heat-conducting
plate

19.27 Consider a circular heat-conducting plate of radius a whose temperature at time $t = 0$ has a distribution function $f(\rho, \varphi)$. Let us find the variation of T for all points (ρ, φ) on the plate for time $t > 0$ when the edge is kept at $T = 0$.

(a) Show that the two-dimensional heat equation, after separation yields the following ODEs:

$$\frac{dg}{dt} = k^2\lambda g, \quad \frac{d^2S}{d\varphi^2} + \mu S = 0,$$

$$\frac{d^2R}{d\rho^2} + \frac{1}{\rho} \frac{dR}{d\rho} - \left(\frac{\mu}{\rho^2} + \lambda\right)R = 0.$$

(b) Show that these DEs leads to the following solutions:

$$g(t) = Ae^{-k^2b^2t}, \quad S(\varphi) = B \cos m\varphi + C \sin m\varphi,$$

$$R(\rho) = DJ_m(b\rho).$$

where $\lambda \equiv -b^2$

(c) Show that the general solution can be written as

$$T(\rho, \varphi, t) = \sum_{m=0}^{\infty} \sum_{n=1}^{\infty} e^{-k^2(x_{mn}/a)^2 t} J_m\left(\frac{x_{mn}}{a}\rho\right) \times (A_{mn} \cos m\varphi + B_{mn} \sin m\varphi).$$

A_{mn} and B_{mn} can be determined as in Sect. 19.6.1.

19.28 Consider a quantum particle in a cylindrical can. For an atomic particle of mass μ confined in a cylindrical can of length L and radius a , the relevant Schrödinger equation is

$$i \frac{\partial \psi}{\partial t} = -\frac{\hbar}{2\mu} \left[\frac{1}{\rho} \frac{\partial}{\partial \rho} \left(\rho \frac{\partial \psi}{\partial \rho} \right) + \frac{1}{\rho^2} \frac{\partial^2 \psi}{\partial \varphi^2} + \frac{\partial^2 \psi}{\partial z^2} \right],$$

subject to the BC that $\psi(\rho, \varphi, z, t)$ vanishes at the sides of the can.

(a) Show that the separation of variables yields

$$\begin{aligned} \frac{dT}{dt} &= -i\omega T, & \frac{d^2 Z}{dz^2} + \lambda Z &= 0, & \frac{d^2 S}{d\varphi^2} + m^2 S &= 0, \\ \frac{d^2 R}{d\rho^2} + \frac{1}{\rho} \frac{dR}{d\rho} + \left(\frac{2\mu}{\hbar} \omega - \lambda - \frac{m^2}{\rho^2} \right) R &= 0. \end{aligned} \quad (19.49)$$

(b) Show that the energy eigenvalues are

$$E_{kmn} \equiv \hbar\omega_{kmn} = \frac{\hbar^2}{2\mu} \left[\left(\frac{k\pi}{L} \right)^2 + \frac{x_{mn}^2}{a^2} \right],$$

where x_{mn} is the n th zero of $J_m(x)$, the Bessel function of order m , and k is related to λ by $\lambda = (k\pi/L)^2$.

(c) Show that the general solution can be written as

$$\begin{aligned} \psi &= \sum_{\substack{k, n=1 \\ m=0}}^{\infty} e^{-i\omega_{kmn} t} J_m\left(\frac{x_{mn}}{a}\rho\right) \sin\left(\frac{k\pi}{L}z\right) \\ &\times (A_{kmn} \cos m\varphi + B_{kmn} \sin m\varphi). \end{aligned}$$

19.29 Find the modes and the corresponding fields of a cylindrical resonant cavity of length L and radius a . Discuss the lowest TM mode.

19.30 Two identical long conducting half-cylindrical shells (cross sections are half-circles) of radius a are glued together in such a way that they are insulated from one another. One half-cylinder is held at potential V_0 and the other is grounded. Find the potential at any point inside the resulting cylinder. Hint: Separate Laplace's equation in two dimensions.

19.31 A linear charge distribution of uniform density λ extends along the z -axis from $z = -b$ to $z = b$. Show that the electrostatic potential at any point $r > b$ is given by

$$\Phi(r, \theta, \varphi) = 2\lambda \sum_{k=0}^{\infty} \frac{(b/r)^{2k+1}}{2k+1} P_{2k}(\cos \theta).$$

Hint: Consider a point on the z -axis at a distance $r > b$ from the origin. Solve the simple problem by integration and compare the result with the infinite series to obtain the unknown coefficients.

19.32 The upper half of a heat-conducting sphere of radius a has temperature T_0 ; the lower half is maintained at temperature $-T_0$. The whole sphere is inside an infinitely large mass of heat-conducting material. Find the steady-state temperature distribution inside and outside the sphere.

19.33 Find the steady-state temperature distribution inside a sphere of radius a when the surface temperature is given by:

- (a) $T_0 \cos^2 \theta$, (b) $T_0 \cos^4 \theta$, (c) $T_0 |\cos \theta|$,
 (d) $T_0(\cos \theta - \cos^3 \theta)$, (e) $T_0 \sin^2 \theta$, (f) $T_0 \sin^4 \theta$.

19.34 Find the electrostatic potential both inside and outside a conducting sphere of radius a when the sphere is maintained at a potential given by

- (a) $V_0(\cos \theta - 3 \sin^2 \theta)$,
 (b) $V_0(5 \cos^3 \theta - 3 \sin^2 \theta)$,
 (c) $\begin{cases} V_0 \cos \theta & \text{for the upper hemisphere,} \\ 0 & \text{for the lower hemisphere.} \end{cases}$

19.35 Find the steady-state temperature distribution inside a solid hemisphere of radius a if the curved surface is held at T_0 and the flat surface at $T = 0$. Hint: Imagine completing the sphere and maintaining the lower hemisphere at a temperature such that the overall surface temperature distribution is an *odd* function about $\theta = \pi/2$.

19.36 Find the steady-state temperature distribution in a spherical shell of inner radius R_1 and outer radius R_2 when the inner surface has a temperature T_1 and the outer surface a temperature T_2 .

Part VI
Green's Functions

Our treatment of differential equations, with the exception of SOLDEs with constant coefficients, did not consider inhomogeneous equations. At this point, however, we can put into use one of the most elegant pieces of machinery in higher mathematics, Green's functions, to solve inhomogeneous differential equations.

This chapter addresses Green's functions in one dimension, that is, Green's functions of ordinary differential equations. Consider the ODE $\mathbf{L}_x[u] = f(x)$ where \mathbf{L}_x is a linear differential operator. In the abstract Dirac notation this can be formally written as $\mathbf{L}|u\rangle = |f\rangle$. If \mathbf{L} has an inverse $\mathbf{L}^{-1} \equiv \mathbf{G}$, the solution can be formally written as $|u\rangle = \mathbf{L}^{-1}|f\rangle = \mathbf{G}|f\rangle$. Multiplying this by $\langle x|$ and inserting $\mathbf{1} = \int dy|y\rangle w(y)\langle y|$ between \mathbf{G} and $|f\rangle$ gives

$$u(x) = \int dy G(x, y)w(y)f(y), \tag{20.1}$$

where the integration is over the range of definition of the functions involved. Once we know $G(x, y)$, Eq. (20.1) gives the solution $u(x)$ in an integral form. But how do we find $G(x, y)$?

Sandwiching both sides of $\mathbf{L}\mathbf{G} = \mathbf{1}$ between $\langle x|$ and $|y\rangle$ and using

$$\mathbf{1} = \int dx'|x'\rangle w(x')\langle x'|$$

between \mathbf{L} and \mathbf{G} yields

$$\int dx' L(x, x')w(x')G(x', y) = \langle x|y\rangle = \frac{\delta(x - y)}{w(x)}$$

if we use Eq. (7.19). In particular, if \mathbf{L} is a local differential operator (see Sect. 17.1), then $L(x, x') = [\delta(x - x')/w(x)]\mathbf{L}_x$, and we obtain

$$\mathbf{L}_x G(x, y) = \frac{\delta(x - y)}{w(x)} \quad \text{or} \quad \mathbf{L}_x G(x, y) = \delta(x - y), \tag{20.2}$$

differential equation for Green's function

where the second equation makes the frequently used assumption that $w(x) = 1$. $G(x, y)$ is called the **Green's function** (GF) for the differential operator (DO) \mathbf{L}_x .

Green's function

As discussed in Chaps. 17 and 19, \mathbf{L}_x might not be defined for all functions on \mathbb{R} . Moreover, a complete specification of \mathbf{L}_x requires some initial (or boundary) conditions. Therefore, we expect $G(x, y)$ to depend on such initial conditions as well. We note that when \mathbf{L}_x is applied to (20.1), we get

$$\begin{aligned}\mathbf{L}_x u(x) &= \int dy [\mathbf{L}_x(G(x, y))]w(y)f(y) \\ &= \int dy \frac{\delta(x-y)}{w(x)}w(y)f(y) = f(x),\end{aligned}$$

indicating that $u(x)$ is indeed a solution of the original ODE. Equation (20.2), involving the generalized function $\delta(x-y)$ (or distribution in the language of Sect. 7.3), is meaningful only in the same context. Thus, we treat $G(x, y)$ not as an ordinary function but as a *distribution*. Finally, (20.1) is assumed to hold for an arbitrary (well-behaved) function f .

20.1 Calculation of Some Green's Functions

This section presents some examples of calculating $G(x, y)$ for very simple DOs. Later we will see how to obtain Green's functions for a general second-order linear differential operator. Although the complete specification of GFs requires boundary conditions, we shall introduce unspecified constants in some of the examples below, and calculate some *indefinite* GFs.

indefinite Green's
Functions

Example 20.1.1 Let us find the GF for the simplest DO, $\mathbf{L}_x = d/dx$. We need to find a distribution such that its derivative is the Dirac delta function:¹ $G'(x, y) = \delta(x-y)$. In Sect. 7.3, we encountered such a distribution—the step function $\theta(x-y)$. Thus,

$$G(x, y) = \theta(x-y) + \alpha(y),$$

where $\alpha(y)$ is the “constant” of integration.

The example above did not include a boundary (or initial) condition. Let us see how boundary conditions affect the resulting GF.

Example 20.1.2 Let us solve $u'(x) = f(x)$ where $x \in [0, \infty)$ and $u(0) = 0$. A general solution of this DE is given by Eq. (20.1) and the preceding example:

$$u(x) = \int_0^\infty \theta(x-y)f(y)dy + \int_0^\infty \alpha(y)f(y)dy.$$

The factor $\theta(x-y)$ in the first term on the RHS chops off the integral at x :

$$u(x) = \int_0^x f(y)dy + \int_0^\infty \alpha(y)f(y)dy.$$

¹Here and elsewhere in this chapter, a prime over a GF indicates differentiation with respect to its first argument.

The BC gives

$$0 = u(0) = 0 + \int_0^{\infty} \alpha(y) f(y) dy.$$

The only way that this can be satisfied for arbitrary $f(y)$ is for $\alpha(y)$ to be zero. Thus, $G(x, y) = \theta(x - y)$, and

$$u(x) = \int_0^{\infty} \theta(x - y) f(y) dy = \int_0^x f(y) dy.$$

This is killing a fly with a sledgehammer! We could have obtained the result by a simple integration. However, the roundabout way outlined here illustrates some important features of GFs that will be discussed later. The BC introduced here is very special. What happens if it is changed to $u(0) = a$? Problem 20.1 answers that.

Example 20.1.3 A more complicated DO is $\mathbf{L}_x = d^2/dx^2$. Let us find its indefinite GF. To do so, we integrate $G''(x, y) = \delta(x - y)$ once with respect to x to obtain

$$\frac{d}{dx} G(x, y) = \theta(x - y) + \alpha(y).$$

A second integration yields

$$G(x, y) = \int dx \theta(x - y) + x\alpha(y) + \eta(y),$$

where α and η are arbitrary functions and the integral is an indefinite integral to be evaluated next.

Let $\Omega(x, y)$ be the primitive of $\theta(x - y)$; that is,

$$\frac{d\Omega}{dx} = \theta(x - y) = \begin{cases} 1 & \text{if } x > y, \\ 0 & \text{if } x < y. \end{cases} \quad (20.3)$$

The solution to this equation is

$$\Omega(x, y) = \begin{cases} x + a(y) & \text{if } x > y, \\ b(y) & \text{if } x < y. \end{cases}$$

Note that we have not defined $\Omega(x, y)$ at $x = y$. It will become clear below that $\Omega(x, y)$ is continuous at $x = y$. It is convenient to write $\Omega(x, y)$ as

$$\Omega(x, y) = [x + a(y)]\theta(x - y) + b(y)\theta(y - x). \quad (20.4)$$

To specify $a(y)$ and $b(y)$ further, we differentiate (20.4) and compare it with (20.3):

$$\begin{aligned} \frac{d\Omega}{dx} &= \theta(x - y) + [x + a(y)]\delta(x - y) - b(y)\delta(x - y) \\ &= \theta(x - y) + [x - b(y) + a(y)]\delta(x - y), \end{aligned} \quad (20.5)$$

where we have used

$$\frac{d}{dx}\theta(x-y) = -\frac{d}{dx}\theta(y-x) = \delta(x-y).$$

For Eq. (20.5) to agree with (20.3), we must have $[x - b(y) + a(y)]\delta(x - y) = 0$, which, upon integration over x , yields $a(y) - b(y) = -y$. Substituting this in the expression for $\Omega(x, y)$ gives

$$\Omega(x, y) = (x - y)\theta(x - y) + b(y)[\theta(x - y) + \theta(y - x)].$$

But $\theta(x) + \theta(-x) = 1$; therefore, $\Omega(x, y) = (x - y)\theta(x - y) + b(y)$. It follows, among other things, that $\Omega(x, y)$ is continuous at $x = y$. We can now write

$$G(x, y) = (x - y)\theta(x - y) + x\alpha(y) + \beta(y),$$

where $\beta(y) = \eta(y) + b(y)$.

The GF in the example above has two arbitrary functions, $\alpha(y)$ and $\beta(y)$, which are the result of underspecification of \mathbf{L}_x : A full specification of \mathbf{L}_x requires BCs, as the following example shows.

Example 20.1.4 Let us calculate the GF of $\mathbf{L}_x[u] = u''(x) = f(x)$ subject to the BC $u(a) = u(b) = 0$ where $[a, b]$ is the interval on which \mathbf{L}_x is defined. Example 20.1.3 gives us the (indefinite) GF for \mathbf{L}_x . Using that, we can write

$$\begin{aligned} u(x) &= \int_a^b (x - y)\theta(x - y)f(y) dy + x \int_a^b \alpha(y)f(y) dy \\ &\quad + \int_a^b \beta(y)f(y) dy \\ &= \int_a^x (x - y)f(y) dy + x \int_a^b \alpha(y)f(y) dy + \int_a^b \beta(y)f(y) dy. \end{aligned}$$

Applying the BCs yields

$$\begin{aligned} 0 = u(a) &= a \int_a^b \alpha(y)f(y) dy + \int_a^b \beta(y)f(y) dy, \\ 0 = u(b) &= \int_a^b (b - y)f(y) dy + b \int_a^b \alpha(y)f(y) dy \\ &\quad + \int_a^b \beta(y)f(y) dy. \end{aligned} \tag{20.6}$$

From these two relations it is possible to determine $\alpha(y)$ and $\beta(y)$: Substitute for the last integral on the RHS of the second equation of (20.6) from the first equation and get

$$0 = \int_a^b [b - y + b\alpha(y) - a\alpha(y)]f(y) dy.$$

Since this must hold for arbitrary $f(y)$, we conclude that

$$b - y + (b - a)\alpha(y) = 0 \Rightarrow \alpha(y) = -\frac{b - y}{b - a}.$$

Substituting for $\alpha(y)$ in the first equation of (20.6) and noting that the result holds for arbitrary f , we obtain $\beta(y) = a(b - y)/(b - a)$. Insertion of $\alpha(y)$ and $\beta(y)$ in the expression for $G(x, y)$ obtained in Example 20.1.3 gives

$$G(x, y) = (x - y)\theta(x - y) + (x - a)\frac{y - b}{b - a} \quad \text{where } a \leq x \text{ and } y \leq b.$$

It is striking that $G(a, y) = (a - y)\theta(a - y) = 0$ (because $a - y \leq 0$), and

$$G(b, y) = (b - y)\theta(b - y) + (b - a)\frac{y - b}{b - a} = 0$$

because $\theta(b - y) = 1$ for all $y \leq b$ [recall that x and y lie in the interval (a, b)]. These two equations reveal the important fact that as a function of x , $G(x, y)$ satisfies the same (homogeneous) BC as the solution of the DE. This is a general property that will be discussed later.

In all the preceding examples, the BCs were very simple. Specifically, the value of the solution and/or its derivative at the boundary points was zero. What if the BCs are not so simple? In particular, how can we handle a case where $u(a)$ [or $u'(a)$] and $u(b)$ [or $u'(b)$] are nonzero?

Consider a general (second-order) differential operator \mathbf{L}_x and the differential equation $\mathbf{L}_x[u] = f(x)$ subject to the BCs $u(a) = a_1$ and $u(b) = b_1$. We claim that we can reduce this system to the case where $u(a) = u(b) = 0$. Recall from Chap. 14 that the most general solution to such a DE is of the form $u = u_h + u_i$ where u_h , the solution to the homogeneous equation, satisfies $\mathbf{L}_x[u_h] = 0$ and contains the arbitrary parameters inherent in solutions of differential equations. For instance, if the linearly independent solutions are v and w , then $u_h(x) = C_1v(x) + C_2w(x)$ and u_i is any solution of the inhomogeneous DE.

If we demand that $u_h(a) = a_1$ and $u_h(b) = b_1$, then u_i satisfies the system

$$\mathbf{L}_x[u_i] = f(x), \quad u_i(a) = u_i(b) = 0,$$

which is of the type discussed in the preceding examples. Since \mathbf{L}_x is a SOLD0, we can put all the machinery of Chap. 14 to work to obtain $v(x)$, $w(x)$, and therefore $u_h(x)$. The problem then reduces to a DE for which the BCs are homogeneous; that is, the value of the solution and/or its derivative is zero at the boundary points.

Example 20.1.5 Let us assume that $\mathbf{L}_x = d^2/dx^2$. Calculation of u_h is trivial:

$$\mathbf{L}_x[u_h] = 0 \Rightarrow \frac{d^2u_h}{dx^2} = 0 \Rightarrow u_h(x) = C_1x + C_2.$$

To evaluate C_1 and C_2 , we impose the BCs $u_h(a) = a_1$ and $u_h(b) = b_1$:

$$C_1 a + C_2 = a_1,$$

$$C_1 b + C_2 = b_1.$$

This gives $C_1 = (b_1 - a_1)/(b - a)$ and $C_2 = (a_1 b - a b_1)/(b - a)$.

The inhomogeneous equation defines a problem identical to that of Example 20.1.4. Thus, we can immediately write $u_i(x) = \int_a^b G(x, y) f(y) dy$, where $G(x, y)$ is as given in that example. Thus, the general solution is

$$u(x) = \frac{b_1 - a_1}{b - a} x + \frac{a_1 b - a b_1}{b - a} + \int_a^x (x - y) f(y) dy \\ + \frac{x - a}{b - a} \int_a^b (y - b) f(y) dy.$$

Example 20.1.5 shows that an inhomogeneous DE with inhomogeneous BCs can be separated into two DEs, one homogeneous with inhomogeneous BCs and the other inhomogeneous with homogeneous BCs, the latter being appropriate for the GF. Furthermore, all the preceding examples indicate that solutions of DEs can be succinctly written in terms of GFs that automatically incorporate the BCs as long as the BCs are homogeneous. Can a GF also give the solution to a homogeneous DE with inhomogeneous BCs?

20.2 Formal Considerations

The discussion and examples of the preceding section hint at the power of Green's functions. The elegance of such a function becomes apparent from the realization that it contains all the information about the solutions of a DE for any type of BCs, as we are about to show. Since GFs are inverses of DOs, let us briefly reexamine the inverse of an operator, which is closely tied to its spectrum.

The question as to whether or not an operator \mathbf{A} in a finite-dimensional vector space is invertible is succinctly answered by the value of its determinant: \mathbf{A} is invertible if and only if $\det \mathbf{A} \neq 0$. In fact, as we saw at the beginning of Chap. 17, one translates the abstract operator equation $\mathbf{A}|u\rangle = |v\rangle$ into a matrix equation $\mathbf{A}u = v$ and reduces the question to that of the inverse of a matrix. This matrix takes on an especially simple form when \mathbf{A} is diagonal, that is, when $A_{ij} = \lambda_i \delta_{ij}$. For this special situation we have

$$\lambda_i u_i = v_i \quad \text{for } i = 1, 2, \dots, N \text{ (no sum over } i\text{)}. \quad (20.7)$$

This equation has a unique solution (for arbitrary v_i) if and only if $\lambda_i \neq 0$ for all i . In that case $u_i = v_i / \lambda_i$ for $i = 1, 2, \dots, N$. In particular, if $v_i = 0$ for all i , that is, when Eq. (20.7) is homogeneous, the unique solution is the trivial solution. On the other hand, when some of the λ_i are zero, there may be no solution to (20.7), but the homogeneous equation has a nontrivial solution (u_i need not be zero). Proposition 6.2.6 applies to vector spaces of finite as well as infinite dimensions. Therefore, we restate it here:

Theorem 20.2.1 *An operator \mathbf{A} on a Hilbert space has an inverse if and only if $\lambda = 0$ is not an eigenvalue of \mathbf{A} . Equivalently, \mathbf{A} is invertible if and only if the homogeneous equation $\mathbf{A}|u\rangle = 0$ has no nontrivial solutions.*

Green's functions are inverses of differential operators. Therefore, it is important to have a clear understanding of the DOs. An n th-order linear differential operator (NOLDO) satisfies the following theorem (for a proof, see [Birk 78, Chap. 6]).

Theorem 20.2.2 *Let*

$$\mathbf{L}_x = p_n(x) \frac{d^n}{dx^n} + p_{n-1}(x) \frac{d^{n-1}}{dx^{n-1}} + \cdots + p_1(x) \frac{d}{dx} + p_0(x) \quad (20.8)$$

where $p_n(x) \neq 0$ in $[a, b]$. Let $x_0 \in [a, b]$ and let $\{\gamma_k\}_{k=1}^n$ be given numbers and $f(x)$ a given piecewise continuous function on $[a, b]$. Then the initial value problem (IVP)

$$\begin{aligned} \mathbf{L}_x[u] &= f \quad \text{for } x \in [a, b], \\ u(x_0) &= \gamma_1, \quad u'(x_0) = \gamma_2, \dots, u^{(n-1)}(x_0) = \gamma_n \end{aligned} \quad (20.9)$$

has one and only one solution.

This is simply the existence and uniqueness theorem for a NOLDE. Equation (20.9) is referred to as the **IVP with data** $\{f(x); \gamma_1, \dots, \gamma_n\}$. This theorem is used to define \mathbf{L}_x . Part of that definition are the BCs that the solutions to \mathbf{L}_x must satisfy.

initial value problem

A particularly important BC is the homogeneous one in which $\gamma_1 = \gamma_2 = \cdots = \gamma_n = 0$. In such a case it can be shown (see Problem 20.3) that the only nontrivial solution of the homogeneous DE $\mathbf{L}_x[u] = 0$ is $u \equiv 0$. Theorem 20.2.1 then tells us that \mathbf{L}_x is invertible; that is, there is a unique operator \mathbf{G} such that $\mathbf{L}\mathbf{G} = \mathbf{1}$. The “components” version of this last relation is part of the content of the next theorem.

Theorem 20.2.3 *The DO \mathbf{L}_x of Eq. (20.8) associated with the IVP with data $\{f(x); 0, 0, \dots, 0\}$ is invertible; that is, there exists a function $G(x, y)$ such that*

$$\mathbf{L}_x G(x, y) = \frac{\delta(x - y)}{w(x)}.$$

The importance of homogeneous BCs can now be appreciated. Theorem 20.2.3 is the reason why we had to impose homogeneous BCs to obtain the GF in all the examples of the previous section.

The BCs in (20.9) clearly are not the only ones that can be used. The most general linear BCs encountered in differential operator theory are

$$\mathbf{R}_i[u] \equiv \sum_{j=1}^n (\alpha_{ij}u^{(j-1)}(a) + \beta_{ij}u^{(j-1)}(b)) = \gamma_i, \quad i = 1, \dots, n. \quad (20.10)$$

The n row vectors $\{(\alpha_{i1}, \dots, \alpha_{in}, \beta_{i1}, \dots, \beta_{in})\}_{i=1}^n$ are assumed to be independent (in particular, no row is identical to zero). We refer to \mathbf{R}_i as **boundary functionals** because for each (sufficiently smooth) function u , they give a number γ_i . The DO of (20.8) and the BCs of (20.10) together form a **boundary value problem (BVP)**. The DE $\mathbf{L}_x[u] = f$ subject to the BCs of (20.10) is a BVP with data $\{f(x); \gamma_1, \dots, \gamma_n\}$.

We note that the \mathbf{R}_i are linear; that is,

$$\mathbf{R}_i[u_1 + u_2] = \mathbf{R}_i[u_1] + \mathbf{R}_i[u_2] \quad \text{and} \quad \mathbf{R}_i[\alpha u] = \alpha \mathbf{R}_i[u].$$

Since \mathbf{L}_x is also linear, we conclude that the superposition principle applies to the system consisting of $\mathbf{L}_x[u] = f$ and the BCs of (20.10), which is sometimes denoted by $(\mathbf{L}; \mathbf{R}_1, \dots, \mathbf{R}_n)$. If u satisfies the BVP with data $\{f; \gamma_1, \dots, \gamma_n\}$ and v satisfies the BVP with data $\{g; \mu_1, \dots, \mu_n\}$, then $\alpha u + \beta v$ satisfies the BVP with data $\{\alpha f + \beta g; \alpha \gamma_1 + \beta \mu_1, \dots, \alpha \gamma_n + \beta \mu_n\}$. It follows that if u and v both satisfy the BVP with data $\{f; \gamma_1, \dots, \gamma_n\}$, then $u - v$ satisfies the BVP with data $\{0; 0, 0, \dots, 0\}$, which is called the **completely homogeneous problem**.

Unlike the IVP, the BVP with data $\{0; 0, 0, \dots, 0\}$ may have a nontrivial solution. If the completely homogeneous problem has no nontrivial solution, then the BVP with data $\{f; \gamma_1, \dots, \gamma_n\}$ has at most one solution (a solution exists for any set of data). On the other hand, if the completely homogeneous problem has nontrivial solutions, then the BVP with data $\{f; \gamma_1, \dots, \gamma_n\}$ either has no solutions or has more than one solution (see [Stak 79, pp. 203–204]).

Recall that when a differential (unbounded) operator \mathbf{L}_x acts in a Hilbert space, such as $\mathcal{L}_w^2(a, b)$, it acts only on its domain. In the context of the present discussion, this means that not all functions in $\mathcal{L}_w^2(a, b)$ satisfy the BCs necessary for defining \mathbf{L}_x . Thus, the functions for which the operator is defined (those that satisfy the BCs) form a subset of $\mathcal{L}_w^2(a, b)$, which we called the domain of \mathbf{L}_x and denoted by $\mathcal{D}(\mathbf{L}_x)$. From a formal standpoint it is important to distinguish among maps that have different domains. For instance, the Hilbert-Schmidt integral operators, which are defined on a finite interval, are compact, while those defined on the entire real line are not.

Definition 20.2.4 Let \mathbf{L}_x be the DO of Eq. (20.8). Suppose there exists a **adjoint of a differential operator** \mathbf{L}_x^\dagger , with the property that

$$w\{v^*(\mathbf{L}_x[u]) - u(\mathbf{L}_x^\dagger[v])^*\} = \frac{d}{dx}Q[u, v^*] \quad \text{for } u, v \in \mathcal{D}(\mathbf{L}_x) \cap \mathcal{D}(\mathbf{L}_x^\dagger),$$

where $Q[u, v^*]$, called the **conjunct** of the functions u and v , depends on u, v , and their derivatives of order up to $n - 1$. The DO \mathbf{L}_x^\dagger is then called the **formal adjoint** of \mathbf{L}_x . If $\mathbf{L}_x^\dagger = \mathbf{L}_x$ (without regard to the BCs imposed

on their solutions), then \mathbf{L}_x is said to be **formally self-adjoint**. If $\mathcal{D}(\mathbf{L}_x^\dagger) \supset \mathcal{D}(\mathbf{L}_x)$ and $\mathbf{L}_x^\dagger = \mathbf{L}_x$ on $\mathcal{D}(\mathbf{L}_x)$, then \mathbf{L}_x is said to be **hermitian**. If $\mathcal{D}(\mathbf{L}_x^\dagger) = \mathcal{D}(\mathbf{L}_x)$ and $\mathbf{L}_x^\dagger = \mathbf{L}_x$, then \mathbf{L}_x is said to be **self-adjoint**.

The relation given in the definition above involving the conjunct is a generalization of the Lagrange identity and can also be written in integral form:

generalized Green's identity

$$\int_a^b dxw\{v^*(\mathbf{L}_x[u])\} - \int_a^b dxw\{u(\mathbf{L}_x^\dagger[v])^*\} = Q[u, v^*]_a^b \quad (20.11)$$

This form is sometimes called the **generalized Green's identity**.

Historical Notes

George Green (1793?–1841) was not appreciated in his lifetime. His date of birth is unknown (however, it is known that he was baptized on 14 July 1793), and no portrait of him survives. He left school, after only one year's attendance, to work in his father's bakery. When the father opened a windmill in Nottingham, the boy used an upper room as a study in which he taught himself physics and mathematics from library books. In 1828, when he was thirty-five years old, he published his most important work, *An Essay on the Application of Mathematical Analysis to the Theory of Electricity and Magnetism* at his own expense. In it Green apologized for any shortcomings in the paper due to his minimal formal education or the limited resources available to him, the latter being apparent in the few previous works he cited. The introduction explained the importance Green placed on the "potential" function. The body of the paper generalizes this idea to electricity and magnetism.



George Green
1793?–1841

In addition to the physics of electricity and magnetism, Green's first paper also contained the monumental mathematical contributions for which he is now famous: The relationship between surface and volume integrals we now call *Green's theorem*, and the *Green's function*, a ubiquitous solution to partial differential equations in almost every area of physics. With little appreciation for the future impact of this work, one of Green's contemporaries declared the publication "a complete failure". The "Essay", which received little notice because of poor circulation, was saved by Lord Kelvin, who tracked it down in a German journal.

When his father died in 1829, some of George's friends urged him to seek a college education. After four years of self-study, during which he closed the gaps in his elementary education, Green was admitted to Caius College of Cambridge University at the age of 40, from which he graduated four years later after a disappointing performance on his final examinations. Later, however, he was appointed Perce Fellow of Caius College. Two years after his appointment he died, and his famous 1828 paper was republished, this time reaching a much wider audience. This paper has been described as "the beginning of mathematical physics in England".

He published only ten mathematical works. In 1833 he wrote three further papers. Two on electricity were published by the Cambridge Philosophical Society. One on hydrodynamics was published by the Royal Society of Edinburgh (of which he was a Fellow) in 1836. He also had two papers on hydrodynamics (in particular wave motion in canals), two papers on reflection and refraction of light, and two papers on reflection and refraction of sound published in Cambridge.

In 1923 the Green windmill was partially restored by a local businessman as a gesture of tribute to Green. Einstein came to pay homage. Then a fire in 1947 destroyed the renovations. Thirty years later the idea of a memorial was once again mooted, and sufficient money was raised to purchase the mill and present it to the sympathetic Nottingham City Council. In 1980 the George Green Memorial Appeal was launched to secure £20,000 to get the sails turning again and the machinery working once more. Today, Green's restored mill stands as a mathematics museum in Nottingham.

20.2.1 Second-Order Linear DOs

Since second-order linear differential operators (SOLDOs) are sufficiently general for most physical applications, we will concentrate on them. Because homogeneous BCs are important in constructing Green's functions, let us first consider BCs of the form

$$\begin{aligned}\mathbf{R}_1[u] &\equiv \alpha_{11}u(a) + \alpha_{12}u'(a) + \beta_{11}u(b) + \beta_{12}u'(b) = 0, \\ \mathbf{R}_2[u] &\equiv \alpha_{21}u(a) + \alpha_{22}u'(a) + \beta_{21}u(b) + \beta_{22}u'(b) = 0,\end{aligned}\quad (20.12)$$

where it is assumed, as usual, that $(\alpha_{11}, \alpha_{12}, \beta_{11}, \beta_{12})$ and $(\alpha_{21}, \alpha_{22}, \beta_{21}, \beta_{22})$ are linearly independent.

If we define the inner product as an integral with weight w , Eq. (20.11) can be formally written as

$$\langle v | \mathbf{L} | u \rangle = \langle u | \mathbf{L}^\dagger | v \rangle^* + \mathcal{Q}[u, v^*] \Big|_a^b.$$

This would coincide with the usual definition of the adjoint if the surface term vanishes, that is, if

$$\mathcal{Q}[u, v^*] \Big|_{x=b} = \mathcal{Q}[u, v^*] \Big|_{x=a}. \quad (20.13)$$

For this to happen, we need to impose BCs on v . To find these BCs, let us rewrite Eq. (20.12) in a more compact form. Linear independence of the two row vectors of coefficients implies that the 2×4 matrix of coefficients has rank two. This means that the 2×4 matrix has an invertible 2×2 submatrix. By rearranging the terms in Eq. (20.12) if necessary, we can assume that the second of the two 2×2 submatrices is invertible. The homogeneous BCs can then be conveniently written as

$$\mathbf{R}[u] = \begin{pmatrix} \mathbf{R}_1[u] \\ \mathbf{R}_2[u] \end{pmatrix} = \begin{pmatrix} \mathbf{A} & \mathbf{B} \end{pmatrix} \begin{pmatrix} \mathbf{u}_a \\ \mathbf{u}_b \end{pmatrix} = \mathbf{A}\mathbf{u}_a + \mathbf{B}\mathbf{u}_b = 0, \quad (20.14)$$

where

$$\begin{aligned}\mathbf{A} &\equiv \begin{pmatrix} \alpha_{11} & \alpha_{12} \\ \alpha_{21} & \alpha_{22} \end{pmatrix}, & \mathbf{B} &\equiv \begin{pmatrix} \beta_{11} & \beta_{12} \\ \beta_{21} & \beta_{22} \end{pmatrix}, & \mathbf{u}_a &\equiv \begin{pmatrix} u(a) \\ u'(a) \end{pmatrix}, \\ \mathbf{u}_b &\equiv \begin{pmatrix} u(b) \\ u'(b) \end{pmatrix},\end{aligned}$$

and \mathbf{B} is invertible.

The most general form of the conjunct for a SOLDO is

$$\begin{aligned}\mathcal{Q}[u, v^*](x) &= q_{11}(x)u(x)v^*(x) + q_{12}(x)u(x)v'^*(x) \\ &\quad + q_{21}(x)u'(x)v^*(x) + q_{22}(x)u'(x)v'^*(x),\end{aligned}$$

which can be written in matrix form as

$$\mathcal{Q}[u, v^*](x) = \mathbf{u}_x^t \mathbf{Q}_x \mathbf{v}_x^* \quad \text{where} \quad \mathbf{Q}_x = \begin{pmatrix} q_{11}(x) & q_{12}(x) \\ q_{21}(x) & q_{22}(x) \end{pmatrix}, \quad (20.15)$$

and u_x and v_x^* have similar definitions as u_a and u_b above. The vanishing of the surface term becomes

$$u_b^t Q_b v_b^* = u_a^t Q_a v_a^*. \quad (20.16)$$

We need to translate this equation into a condition on v^* *alone*.² This is accomplished by solving for two of the four quantities $u(a)$, $u'(a)$, $u(b)$, and $u'(b)$ in terms of the other two, substituting the result in Eq. (20.16), and setting the coefficients of the other two equal to zero. Let us assume, as before, that the submatrix \mathbf{B} is invertible, i.e., $u(b)$ and $u'(b)$ are expressible in terms of $u(a)$ and $u'(a)$. Then $u_b = -\mathbf{B}^{-1}\mathbf{A}u_a$, or $u_b^t = -u_a^t \mathbf{A}^t (\mathbf{B}^t)^{-1}$, and we obtain

$$-u_a^t \mathbf{A}^t (\mathbf{B}^t)^{-1} Q_b v_b^* = u_a^t Q_a v_a^* \Rightarrow u_a^t [\mathbf{A}^t (\mathbf{B}^t)^{-1} Q_b v_b^* + Q_a v_a^*] = 0,$$

and the condition on v^* becomes

$$\mathbf{A}^t (\mathbf{B}^t)^{-1} Q_b v_b^* + Q_a v_a^* = 0. \quad (20.17)$$

We see that all factors of u have disappeared, as they should. The expanded version of the BCs on v^* are written as

$$\begin{aligned} \mathbf{B}_1[v^*] &\equiv \sigma_{11}v^*(a) + \sigma_{12}v'^*(a) + \eta_{11}v^*(b) + \eta_{12}v'^*(b) = 0, \\ \mathbf{B}_2[v^*] &\equiv \sigma_{21}v^*(a) + \sigma_{22}v'^*(a) + \eta_{21}v^*(b) + \eta_{22}v'^*(b) = 0. \end{aligned} \quad (20.18)$$

These homogeneous BCs are said to be **adjoint** to those of (20.12). Because of the difference between BCs and their adjoints, the domain of a differential operator need not be the same as that of its adjoint. adjoint boundary conditions

Example 20.2.5 Let $\mathbf{L}_x = d^2/dx^2$ with the homogeneous BCs

$$\mathbf{R}_1[u] = \alpha u(a) - u'(a) = 0 \quad \text{and} \quad \mathbf{R}_2[u] = \beta u(b) - u'(b) = 0. \quad (20.19)$$

We want to calculate $Q[u, v^*]$ and the adjoint BCs for v . By repeated integration by parts [or by using Eq. (14.22)], we obtain $Q[u, v^*] = u'v^* - uv'^*$. For the surface term to vanish, we must have

$$u'(a)v^*(a) - u(a)v'^*(a) = u'(b)v^*(b) - u(b)v'^*(b).$$

Substituting from (20.19) in this equation, we get

$$u(a)[\alpha v^*(a) - v'^*(a)] = u(b)[\beta v^*(b) - v'^*(b)],$$

which holds for arbitrary u if and only if

$$\mathbf{B}_1[v^*] = \alpha v^*(a) - v'^*(a) = 0 \quad \text{and} \quad \mathbf{B}_2[v^*] = \beta v^*(b) - v'^*(b) = 0. \quad (20.20)$$

This is a special case, in which the adjoint boundary conditions are the same as the original BCs (substitute u for v^* to see this).

²The boundary conditions on v^* should not depend on the choice of u .

To see that the original BCs and their adjoints need not be the same, we consider

$$\mathbf{R}_1[u] = u'(a) - \alpha u(b) = 0 \quad \text{and} \quad \mathbf{R}_2[u] = \beta u(a) - u'(b) = 0, \quad (20.21)$$

from which we obtain $u(a)[\beta v^*(b) + v'^*(a)] = u(b)[\alpha v^*(a) + v'^*(b)]$. Thus,

$$\text{mixed and unmixed BCs} \quad \mathbf{B}_1[v^*] = \alpha v^*(a) + v'^*(b) = 0 \quad \text{and} \quad \mathbf{B}_2[v^*] = \beta v^*(b) + v'^*(a) = 0, \quad (20.22)$$

which is not the same as (20.21). Boundary conditions such as those in (20.19) and (20.20), in which each equation contains the function and its derivative evaluated at the same point, are called **unmixed BCs**. On the other hand, (20.21) and (20.22) are mixed BCs.

20.2.2 Self-adjoint SOLDOs

In Chap. 14, we showed that a SOLDO satisfies the generalized Green's identity with $w(x) = 1$. In fact, since u and v are real, Eq. (14.23) is identical to (20.11) if we set $w = 1$ and

$$Q[u, v] = p_2 v u' - (p_2 v)' u + p_1 u v. \quad (20.23)$$

Also, we have seen that any SOLDO can be made (formally) self-adjoint. Thus, let us consider the formally self-adjoint SOLDO

$$\mathbf{L}_x = \mathbf{L}_x^\dagger = \frac{d}{dx} \left(p \frac{d}{dx} \right) + q$$

where both $p(x)$ and $q(x)$ are real functions and the inner product is defined with weight $w = 1$. If we are interested in formally self-adjoint operators with respect to a general weight $w > 0$, we can construct them as follows. We first note that if \mathbf{L}_x is formally self-adjoint with respect to a weight of unity, then $(1/w)\mathbf{L}_x$ is self-adjoint with respect to weight w . Next, we note that \mathbf{L}_x is formally self-adjoint for all functions q , in particular, for wq . Now we define

$$\mathbf{L}_x^{(w)} = \frac{d}{dx} \left(p \frac{d}{dx} \right) + qw$$

and note that $\mathbf{L}_x^{(w)}$ is formally self-adjoint with respect to a weight of unity, and therefore

$$\mathbf{L}_x \equiv \frac{1}{w} \mathbf{L}_x^{(w)} = \frac{1}{w} \frac{d}{dx} \left(p \frac{d}{dx} \right) + q \quad (20.24)$$

is formally self-adjoint with respect to weight $w(x) > 0$.

For SOLDOs that are formally self-adjoint with respect to weight w , the conjunct given in (20.23) becomes

$$Q[u, v] = p(x)w(x)(vu' - uv'). \quad (20.25)$$

Thus, the surface term in the generalized Green's identity vanishes if and only if

$$\begin{aligned}
 & p(b)w(b)[v(b)u'(b) - u(b)v'(b)] \\
 &= p(a)w(a)[v(a)u'(a) - u(a)v'(a)]. \tag{20.26}
 \end{aligned}$$

The DO becomes self-adjoint if u and v satisfy Eq. (20.26) as well as *the same BCs*. It can easily be shown that the following four types of BCs on $u(x)$ assure the validity of Eq. (20.26) and therefore define a self-adjoint operator \mathbf{L}_x given by (20.24):

1. The **Dirichlet** BCs: $u(a) = u(b) = 0$
2. The **Neumann** BCs: $u'(a) = u'(b) = 0$
3. **General unmixed** BCs: $\alpha u(a) - u'(a) = \beta u(b) - u'(b) = 0$
4. **Periodic** BCs: $u(a) = u(b)$ and $u'(a) = u'(b)$

common types of boundary conditions for a SOLDE

20.3 Green's Functions for SOLDOS

We are now in a position to find the Green's function for a SOLDO. First, note that a complete specification of \mathbf{L}_x requires not only knowledge of $p_0(x)$, $p_1(x)$, and $p_2(x)$ —its coefficient functions—but also knowledge of the BCs imposed on the solutions. The most general BCs for a SOLDO are of the type given in Eq. (20.10) with $n = 2$. Thus, to specify \mathbf{L}_x uniquely, we consider the system $(\mathbf{L}; \mathbf{R}_1, \mathbf{R}_2)$ with data $(f; \gamma_1, \gamma_2)$. This system defines a unique BVP:

$$\begin{aligned}
 \mathbf{L}_x[u] &= p_2(x) \frac{d^2u}{dx^2} + p_1(x) \frac{du}{dx} + p_0(x)u = f(x), \tag{20.27} \\
 \mathbf{R}_i[u] &= \gamma_i, \quad i = 1, 2.
 \end{aligned}$$

A necessary condition for \mathbf{L}_x to be invertible is that the homogeneous DE $\mathbf{L}_x[u] = 0$ have only the trivial solution $u = 0$. For $u = 0$ to be the *only* solution, it must be a solution. This means that it must meet all the conditions in Eq. (20.27). In particular, since \mathbf{R}_i are linear functionals of u , we must have $\mathbf{R}_i[0] = 0$. This can be stated as follows:

Lemma 20.3.1 *A necessary condition for a second-order linear DO to be invertible is for its associated BCs to be homogeneous.*³

Thus, to study Green's functions we must restrict ourselves to problems with homogeneous BCs. This at first may seem restrictive, since not all problems have homogeneous BCs. Can we solve the others by the Green's function method? The answer is yes, as will be shown later in this chapter.

The above discussion clearly indicates that the Green's function of \mathbf{L}_x , being its "inverse", is defined only if we consider the system $(\mathbf{L}; \mathbf{R}_1, \mathbf{R}_2)$ with data $(f; 0, 0)$. If the Green's function exists, it must satisfy the DE of

³The lemma applies to all linear DOs, not just second order ones.

formal definition of
Green's function

Theorem 20.2.3, in which \mathbf{L}_x acts on $G(x, y)$. But part of the definition of \mathbf{L}_x are the BCs imposed on the solutions. Thus, if the LHS of the DE is to make any sense, $G(x, y)$ must also satisfy those same BCs. We therefore make the following definition:

Definition 20.3.2 The **Green's function** of a DO \mathbf{L}_x is a function $G(x, y)$ that satisfies both the DE

$$\mathbf{L}_x G(x, y) = \frac{\delta(x - y)}{w(x)}$$

and, as a function of x , the homogeneous BCs $\mathbf{R}_i[G] = 0$ for $i = 1, 2$ where the \mathbf{R}_i are defined as in Eq. (20.12).

It is convenient to study the Green's function for the adjoint of \mathbf{L}_x simultaneously. Denoting this by $g(x, y)$, we have

$$\mathbf{L}_x^\dagger g(x, y) = \frac{\delta(x - y)}{w(x)}, \quad \mathbf{B}_i[g] = 0, \quad \text{for } i = 1, 2, \quad (20.28)$$

adjoint Green's function

where \mathbf{B}_i are the boundary functionals adjoint to \mathbf{R}_i and given in Eq. (20.18). The function $g(x, y)$ is known as the **adjoint Green's function** associated with the DE of (20.27).

We can now use (20.27) and (20.28) to find the solutions to

$$\begin{aligned} \mathbf{L}_x[u] &= f(x), & \mathbf{R}_i[u] &= 0 \quad \text{for } i = 1, 2, \\ \mathbf{L}_x^\dagger[v] &= h(x), & \mathbf{B}_i[v^*] &= 0 \quad \text{for } i = 1, 2. \end{aligned} \quad (20.29)$$

With $v(x) = g(x, y)$ in Eq. (20.11)—whose RHS is assumed to be zero—we get $\int_a^b w g^*(x, y) \mathbf{L}_x[u] dx = \int_a^b w u(x) (\mathbf{L}_x^\dagger[g])^* dx$. Using (20.28) on the RHS and (20.29) on the LHS, we obtain

$$u(y) = \int_a^b g^*(x, y) w(x) f(x) dx.$$

Similarly, with $u(x) = G(x, y)$, Eq. (20.11) gives

$$v^*(y) = \int_a^b G(x, y) w(x) h^*(x) dx,$$

or, since $w(x)$ is a (positive) real function,

$$v(y) = \int_a^b G^*(x, y) w(x) h(x) dx.$$

These equations for $u(y)$ and $v(y)$ are not what we expect [see, for instance, Eq. (20.1)]. However, if we take into account certain properties of Green's functions that we will discuss next, these equations become plausible.

20.3.1 Properties of Green's Functions

Let us rewrite the generalized Green's identity [Eq. (20.11)], with the RHS equal to zero, as

$$\int_a^b dt w(t) \{v^*(t)(\mathbf{L}_t[u])\} = \int_a^b dt w(t) \{u(t)(\mathbf{L}_t^\dagger[v])^*\}. \quad (20.30)$$

This is sometimes called **Green's identity**. Substituting $G(t, y)$ for $u(t)$ and $g(t, x)$ for $v(t)$ gives

$$\int_a^b dt w(t) g^*(t, x) \frac{\delta(t - y)}{w(t)} = \int_a^b dt w(t) G(t, y) \frac{\delta(t - x)}{w(t)},$$

or $g^*(y, x) = G(x, y)$. A consequence of this identity is

Proposition 20.3.3 *$G(x, y)$ must satisfy the adjoint boundary conditions with respect to its second argument.*

If for the time being we assume that the Green's function associated with a system $(\mathbf{L}; \mathbf{R}_1, \mathbf{R}_2)$ is unique, then, since for a self-adjoint differential operator, \mathbf{L}_x and \mathbf{L}_x^\dagger are identical and u and v both satisfy the same BCs, we must have $G(x, y) = g(x, y)$ or, using $g^*(y, x) = G(x, y)$, we get $G(x, y) = G^*(y, x)$. In particular, if the coefficient functions of \mathbf{L}_x are all real, $G(x, y)$ will be real, and we have $G(x, y) = G(y, x)$. We thus have

Proposition 20.3.4 *The Green's function is a symmetric function of its two arguments: $G(x, y) = G(y, x)$.*

The last property is related to the continuity of $G(x, y)$ and its derivative at $x = y$. For a SOLDO, we have

$$\mathbf{L}_x G(x, y) = p_2(x) \frac{\partial^2 G}{\partial x^2} + p_1(x) \frac{\partial G}{\partial x} + p_0(x) G = \frac{\delta(x - y)}{w(x)},$$

where $p_0, p_1,$ and p_2 are assumed to be real and continuous in the interval $[a, b]$, and $w(x)$ and $p_2(x)$ are assumed to be positive for all $x \in [a, b]$. We multiply both sides of the DE by

$$h(x) = \frac{\mu(x)}{p_2(x)}, \quad \text{where} \quad \mu(x) \equiv \exp \left[\int_a^x \frac{p_1(t)}{p_2(t)} dt \right],$$

noting that $d\mu/dx = (p_1/p_2)\mu$. This transforms the DE into

$$\frac{\partial}{\partial x} \left[\mu(x) \frac{\partial}{\partial x} G(x, y) \right] + \frac{p_0(x)\mu(x)}{p_2(x)} G(x, y) = \frac{\mu(y)}{p_2(y)w(y)} \delta(x - y).$$

Integrating this equation gives

$$\mu(x) \frac{\partial}{\partial x} G(x, y) + \int_a^x \frac{p_0(t)\mu(t)}{p_2(t)} G(t, y) dt = \frac{\mu(y)}{p_2(y)w(y)} \theta(x - y) + \alpha(y) \quad (20.31)$$

because the primitive of $\delta(x - y)$ is $\theta(x - y)$. Here $\alpha(y)$ is the “constant” of integration. First consider the case where $p_0 = 0$, for which the Green's function will be denoted by $G_0(x, y)$. Then Eq. (20.31) becomes

$$\mu(x) \frac{\partial}{\partial x} G_0(x, y) = \frac{\mu(y)}{p_2(y)w(y)} \theta(x - y) + \alpha_1(y),$$

which (since μ , p_2 , and w are continuous on $[a, b]$, and $\theta(x - y)$ has a discontinuity only at $x = y$) indicates that $\partial G_0/\partial x$ is continuous everywhere on $[a, b]$ except at $x = y$. Now divide the last equation by μ and integrate the result to get

$$G_0(x, y) = \frac{\mu(y)}{p_2(y)w(y)} \int_a^x \frac{\theta(t - y)}{\mu(t)} dt + \alpha_1(y) \int_a^x \frac{dt}{\mu(t)} + \alpha_2(y).$$

Every term on the RHS is continuous except possibly the integral involving the θ -function. However, that integral can be written as

$$\int_a^x \frac{\theta(t - y)}{\mu(t)} dt = \theta(x - y) \int_y^x \frac{dt}{\mu(t)}. \quad (20.32)$$

The θ -function in front of the integral is needed to ensure that $a \leq y \leq x$ as demanded by the LHS of Eq. (20.32). The RHS of Eq. (20.32) is continuous at $x = y$ with limit being zero as $x \rightarrow y$.

Next, we write $G(x, y) = G_0(x, y) + H(x, y)$, and apply \mathbf{L}_x to both sides. This gives

$$\begin{aligned} \frac{\delta(x - y)}{w(x)} &= \left(p_2 \frac{d^2}{dx^2} + p_1 \frac{d}{dx} \right) G_0 + p_0 G_0 + \mathbf{L}_x H(x, y) \\ &= \frac{\delta(x - y)}{w(x)} + p_0 G_0 + \mathbf{L}_x H(x, y), \end{aligned}$$

or $p_2 H'' + p_1 H' + p_0 H = -p_0 G_0$. The continuity of G_0 , p_0 , p_1 , and p_2 on $[a, b]$ implies the continuity of H , because a discontinuity in H would entail a delta function discontinuity in dH/dx , which is impossible because there are no delta functions in the equation for H . Since both G_0 and H are continuous, G must also be continuous on $[a, b]$.

We can now calculate the jump in $\partial G/\partial x$ at $x = y$. We denote the jump as $\Delta G'(y)$ and define it as follows:

$$\Delta G'(y) \equiv \lim_{\epsilon \rightarrow 0} \left[\frac{\partial G}{\partial x}(x, y) \Big|_{x=y+\epsilon} - \frac{\partial G}{\partial x}(x, y) \Big|_{x=y-\epsilon} \right].$$

Dividing (20.31) by $\mu(x)$ and taking the above limit for all terms, we obtain

$$\begin{aligned} \Delta G'(y) + \lim_{\epsilon \rightarrow 0} \left[\frac{1}{\mu(y + \epsilon)} \int_a^{y+\epsilon} \frac{p_0(t)\mu(t)}{p_2(t)} G(t, y) dt \right. \\ \left. - \frac{1}{\mu(y - \epsilon)} \int_a^{y-\epsilon} \frac{p_0(t)\mu(t)}{p_2(t)} G(t, y) dt \right] \end{aligned}$$

$$= \frac{\mu(y)}{p_2(y)w(y)} \lim_{\epsilon \rightarrow 0} \left[\overbrace{\frac{\theta(+\epsilon)}{\mu(y+\epsilon)}}^{=1} - \overbrace{\frac{\theta(-\epsilon)}{\mu(y-\epsilon)}}^{=0} \right].$$

The second term on the LHS is zero because all functions are continuous at y . The limit on the RHS is simply $1/\mu(y)$. We therefore obtain

$$\Delta G'(y) = \frac{1}{p_2(y)w(y)}. \tag{20.33}$$

20.3.2 Construction and Uniqueness of Green's Functions

We are now in a position to calculate the Green's function for a general SOLDOS and show that it is unique.

Theorem 20.3.5 Consider the system $(\mathbf{L}; \mathbf{R}_1, \mathbf{R}_2)$ with data $(f; 0, 0)$, in which \mathbf{L}_x is a SOLDOS. If the homogeneous DE $\mathbf{L}_x[u] = 0$ has no nontrivial solution, then the GF associated with the given system exists and is unique. The solution of the system is $u(x) = \int_a^b dy w(y)G(x, y)f(y)$ and is also unique.

Proof The GF satisfies the DE $\mathbf{L}_x G(x, y) = 0$ for all $x \in [a, b]$ except $x = y$. We thus divide $[a, b]$ into two intervals, $I_1 = [a, y)$ and $I_2 = (y, b]$, and note that a general solution to the above homogeneous DE can be written as a linear combination of a basis of solutions, u_1 and u_2 . Thus, we can write the solution of the DE as

$$\begin{aligned} G_l(x, y) &= c_1 u_1(x) + c_2 u_2(x) \quad \text{for } x \in I_1 \\ G_r(x, y) &= d_1 u_1(x) + d_2 u_2(x) \quad \text{for } x \in I_2 \end{aligned}$$

and define the GF as

$$G(x, y) = \begin{cases} G_l(x, y) & \text{if } x \in I_1, \\ G_r(x, y) & \text{if } x \in I_2, \end{cases} \tag{20.34}$$

where c_1, c_2, d_1 , and d_2 are, in general, functions of y . To determine $G(x, y)$ we must determine four unknowns. We also have four relations: the continuity of G , the jump in $\partial G/\partial x$ at $x = y$, and the two BCs $\mathbf{R}_1[G] = \mathbf{R}_2[G] = 0$. The continuity of G gives

$$c_1(y)u_1(y) + c_2(y)u_2(y) = d_1(y)u_1(y) + d_2(y)u_2(y).$$

The jump of $\partial G/\partial x$ at $x = y$ yields

$$c_1(y)u_1'(y) + c_2(y)u_2'(y) - d_1(y)u_1'(y) - d_2(y)u_2'(y) = -\frac{1}{p_2(y)w(y)}.$$

existence and uniqueness of GF for a second order linear differential operator

Introducing $b_1 = c_1 - d_1$ and $b_2 = c_2 - d_2$ changes the two preceding equations to

$$\begin{aligned} b_1 u_1 + b_2 u_2 &= 0, \\ b_1 u'_1 + b_2 u'_2 &= -\frac{1}{p_2 w}. \end{aligned}$$

These equations have a unique solution iff

$$\det \begin{pmatrix} u_1 & u_2 \\ u'_1 & u'_2 \end{pmatrix} \neq 0.$$

But the determinant is simply the Wronskian of the two independent solutions and therefore cannot be zero. Thus, $b_1(y)$ and $b_2(y)$ are determined in terms of $u_1, u'_1, u_2, u'_2, p_2$, and w .

We now define

$$h(x, y) \equiv \begin{cases} b_1(y)u_1(x) + b_2(y)u_2(x) & \text{if } x \in I_1, \\ 0 & \text{if } x \in I_2. \end{cases}$$

so that $G(x, y) = h(x, y) + d_1(y)u_1(x) + d_2(y)u_2(x)$. We have reduced the number of unknowns to two, d_1 and d_2 . Imposing the BCs gives two more relations:

$$\mathbf{R}_1[G] = \mathbf{R}_1[h] + d_1 \mathbf{R}_1[u_1] + d_2 \mathbf{R}_1[u_2] = 0,$$

$$\mathbf{R}_2[G] = \mathbf{R}_2[h] + d_1 \mathbf{R}_2[u_1] + d_2 \mathbf{R}_2[u_2] = 0.$$

Can we solve these equations and determine d_1 and d_2 uniquely? We can, if

$$\det \begin{pmatrix} \mathbf{R}_1[u_1] & \mathbf{R}_1[u_2] \\ \mathbf{R}_2[u_1] & \mathbf{R}_2[u_2] \end{pmatrix} \neq 0.$$

It can be shown that this determinant is nonzero (see Problem 20.5).

Having found the unique $\{b_i, d_i\}_{i=1}^2$, we can calculate c_i uniquely, substitute all of them in Eq. (20.34), and obtain the unique $G(x, y)$. That $u(x)$ is also unique can be shown similarly. \square

Example 20.3.6 Let us calculate the GF for $\mathbf{L}_x = d^2/dx^2$ with BCs $u(a) = u(b) = 0$. We note that $\mathbf{L}_x[u] = 0$ with the given BCs has no nontrivial solution (verify this). Thus, the GF exists. The DE for $G(x, y)$ is $G'' = 0$ for $x \neq y$, whose solutions are

$$G(x, y) = \begin{cases} c_1 x + c_2 & \text{if } a \leq x < y, \\ d_1 x + d_2 & \text{if } y < x \leq b. \end{cases} \quad (20.35)$$

Continuity at $x = y$ gives $c_1 y + c_2 = d_1 y + d_2$ or $b_1 y + b_2 = 0$ with $b_i = c_i - d_i$. The discontinuity of dG/dx at $x = y$ gives

$$d_1 - c_1 = \frac{1}{p_2 w} = 1 \quad \Rightarrow \quad b_1 = -1$$

assuming that $w = 1$. From the equations above we also get $b_2 = y$. $G(x, y)$ must also satisfy the given BCs. Thus, $G(a, y) = 0 = G(b, y)$. Since $a \leq y$ and $b \geq y$, we obtain $c_1 a + c_2 = 0$ and $d_1 b + d_2 = 0$, or, after substituting $c_i = b_i + d_i$,

$$ad_1 + d_2 = a - y, \quad bd_1 + d_2 = 0.$$

The solution to these equations is $d_1 = (y - a)/(b - a)$ and $d_2 = -b(y - a)/(b - a)$. With b_1, b_2, d_1 , and d_2 as given above, we find

$$c_1 = b_1 + d_1 = -\frac{b - y}{b - a} \quad \text{and} \quad c_2 = b_2 + d_2 = a \frac{b - y}{b - a}.$$

Writing Eq. (20.35) as

$$G(x, y) = (c_1 x + c_2)\theta(y - x) + (d_1 x + d_2)\theta(x - y)$$

and using the identity $\theta(y - x) = 1 - \theta(x - y)$, we get

$$G(x, y) = c_1 x + c_2 - (b_1 x + b_2)\theta(x - y).$$

Using the values found for the b 's and c 's, we obtain

$$G(x, y) = (a - x) \left(\frac{b - y}{b - a} \right) + (x - y)\theta(x - y),$$

which is the same as the GF obtained in Example 20.1.4.

Example 20.3.7 Let us find the GF for $\mathbf{L}_x = d^2/dx^2 + 1$ with the BCs $u(0) = u(\pi/2) = 0$. The general solution of $\mathbf{L}_x[u] = 0$ is

$$u(x) = A \sin x + B \cos x.$$

If the BCs are imposed, we get $u = 0$. Thus, $G(x, y)$ exists. The general form of $G(x, y)$ is

$$G(x, y) = \begin{cases} c_1 \sin x + c_2 \cos x & \text{if } 0 \leq x < y, \\ d_1 \sin x + d_2 \cos x & \text{if } y < x \leq \pi/2. \end{cases} \quad (20.36)$$

Continuity of G at $x = y$ gives $b_1 \sin y + b_2 \cos y = 0$ with $b_i = c_i - d_i$. The discontinuity of the derivative of G at $x = y$ gives $b_1 \cos y - b_2 \sin y = -1$, where we have set $w(x) = 1$. Solving these equations yields $b_1 = -\cos y$ and $b_2 = \sin y$. The BCs give

$$G(0, y) = 0 \Rightarrow c_2 = 0 \Rightarrow d_2 = -b_2 = -\sin y,$$

$$G(\pi/2, y) = 0 \Rightarrow d_1 = 0 \Rightarrow c_1 = -b_1 = -\cos y.$$

Substituting in Eq. (20.36) gives

$$G(x, y) = \begin{cases} -\cos y \sin x & \text{if } x < y, \\ -\sin y \cos x & \text{if } y < x, \end{cases}$$

or, using the theta function,

$$\begin{aligned} G(x, y) &= -\theta(y-x)\cos y\sin x - \theta(y-x)\sin y\cos x \\ &= -[1-\theta(x-y)]\cos y\sin x - \theta(x-y)\sin y\cos x \\ &= -\cos y\sin x + \theta(x-y)\sin(x-y). \end{aligned}$$

It is instructive to verify directly that $G(x, y)$ satisfies $\mathbf{L}_x[G] = \delta(x-y)$:

$$\begin{aligned} \mathbf{L}_x[G] &= -\cos y \underbrace{\left(\frac{d^2}{dx^2} + 1\right)\sin x}_{=0} + \left(\frac{d^2}{dx^2} + 1\right)[\theta(x-y)\sin(x-y)] \\ &= \frac{d^2}{dx^2}[\theta(x-y)\sin(x-y)] + \theta(x-y)\sin(x-y) \\ &= \frac{d}{dx} \underbrace{[\delta(x-y)\sin(x-y)]}_{=0} + \theta(x-y)\cos(x-y) \\ &\quad + \theta(x-y)\sin(x-y). \end{aligned}$$

The first term vanishes because the sine vanishes at the only point where the delta function is nonzero. Thus, we have

$$\begin{aligned} \mathbf{L}_x[G] &= [\delta(x-y)\cos(x-y) - \theta(x-y)\sin(x-y)] \\ &\quad + \theta(x-y)\sin(x-y) \\ &= \delta(x-y) \end{aligned}$$

because the delta function demands that $x = y$, for which $\cos(x-y) = 1$.

The existence and uniqueness of the Green's function $G(x, y)$ in conjunction with its properties and its adjoint, imply the existence and uniqueness of the adjoint Green's function $g(x, y)$. Using this fact, we can show that the condition for the absence of a nontrivial solution for $\mathbf{L}_x[u] = 0$ is also a necessary condition for the existence of $G(x, y)$. That is, if $G(x, y)$ exists, then $\mathbf{L}_x[u] = 0$ implies that $u = 0$. Suppose $G(x, y)$ exists; then $g(x, y)$ also exists. In Green's identity let $v = g(x, y)$. This gives an identity:

$$\begin{aligned} \int_a^b w(x)g^*(x, y)(\mathbf{L}_x[u]) dx &= \int_a^b w(x)u(x)(\mathbf{L}_x^\dagger[g])^* dx \\ &= \int_a^b w(x)u(x)\frac{\delta(x-y)}{w(x)} dx = u(y). \end{aligned}$$

In particular, if $\mathbf{L}_x[u] = 0$, then $u(y) = 0$ for all y . We have proved the following result.

Proposition 20.3.8 *The DE $\mathbf{L}_x[u] = 0$ implies that $u \equiv 0$ if and only if the GF corresponding to \mathbf{L}_x and the homogeneous BCs exist.*

It is sometimes stated that the Green's function of a SOLDOS with constant coefficients depends on the difference $x - y$. This statement is motivated by the observation that if $u(x)$ is a solution of

$$\mathbf{L}_x[u] = a_2 \frac{d^2u}{dx^2} + a_1 \frac{du}{dx} + a_0u = f(x),$$

then $u(x - y)$ is the solution of $a_2u'' + a_1u' + a_0u = f(x - y)$ if a_0, a_1 , and a_2 are constant. Thus, if $G(x)$ is a solution of $\mathbf{L}_x[G] = \delta(x)$ [again assuming that $w(x) = 1$], then it seems that the solution of $\mathbf{L}_x[G] = \delta(x - y)$ is simply $G(x - y)$. This is clearly wrong, as Examples 20.3.6 and 20.3.7 showed. The reason is, of course, the BCs. The fact that $G(x - y)$ satisfies the right DE does not guarantee that it also satisfies the right BCs. The following example, however, shows that the conjecture is true for a homogeneous *initial value problem*.

Example 20.3.9 The most general form for the GF is

$$G(x, y) = \begin{cases} c_1u_1(x) + c_2u_2(x) & \text{if } a \leq x < y, \\ d_1u_1(x) + d_2u_2(x) & \text{if } y < x \leq b. \end{cases}$$

The IVP condition $G(a, y) = 0 = G'(a, y)$ implies

$$c_1u_1(a) + c_2u_2(a) = 0 \quad \text{and} \quad c_1u_1'(a) + c_2u_2'(a) = 0.$$

Linear independence of u_1 and u_2 implies

$$\det \begin{pmatrix} u_1(a) & u_2(a) \\ u_1'(a) & u_2'(a) \end{pmatrix} = W(a; u_1, u_2) \neq 0.$$

Hence, $c_1 = c_2 = 0$ is the only solution. This gives

$$G(x, y) = \begin{cases} 0 & \text{if } a \leq x < y, \\ d_1u_1(x) + d_2u_2(x) & \text{if } y < x \leq b. \end{cases} \quad (20.37)$$

Continuity of G at $x = y$ yields $d_1u_1(y) + d_2u_2(y) = 0$, while the discontinuity jump condition in the derivative gives $d_1u_1'(y) + d_2u_2'(y) = 1$. Solving these two equations, we get

$$d_1 = \frac{u_2(y)}{u_1'(y)u_2(y) - u_2'(y)u_1(y)}, \quad d_2 = -\frac{u_1(y)}{u_1'(y)u_2(y) - u_2'(y)u_1(y)}.$$

Substituting this in (20.37) gives

$$G(x, y) = \left[\frac{u_2(y)u_1(x) - u_1(y)u_2(x)}{u_1'(y)u_2(y) - u_2'(y)u_1(y)} \right] \theta(x - y). \quad (20.38)$$

Equation (20.38) holds for any SOLDOS with the given BCs. We now use the fact that the SOLDOS has *constant coefficients*. In that case, we know the exact form of u_1 and u_2 . There are two cases to consider:

1. If the characteristic polynomial of \mathbf{L}_x has two distinct roots λ_1 and λ_2 , then $u_1(x) = e^{\lambda_1 x}$ and $u_2(x) = e^{\lambda_2 x}$. Writing $\lambda_1 = a + b$ and $\lambda_2 = a - b$ and substituting the exponential functions and their derivatives in Eq. (20.38) yields

$$G(x, y) = \left[\frac{e^{(a-b)y} e^{(a+b)x} - e^{(a+b)y} e^{(a-b)x}}{2be^{2ay}} \right] \theta(x - y) = \frac{1}{2b} [e^{(a+b)(x-y)} - e^{(a-b)(x-y)}] \theta(x - y),$$

which is a function of $x - y$ alone.

2. If $\lambda_1 = \lambda_2 = \lambda$, then $u_1(x) = e^{\lambda x}$, $u_2(x) = x e^{\lambda x}$, and substitution of these functions in Eq. (20.38) gives

$$G(x, y) = (x - y)e^{\lambda(x-y)}\theta(x - y).$$

20.3.3 Inhomogeneous BCs

So far we have concentrated on problems with homogeneous BCs, $\mathbf{R}_i[u] = 0$, for $i = 1, 2$. What if the BCs are inhomogeneous? It turns out that the Green's function method, even though it was derived for homogeneous BCs, solves this kind of problem as well! The secret of this success is the generalized Green's identity. Suppose we are interested in solving the DE

$$\mathbf{L}_x[u] = f(x) \quad \text{with} \quad \mathbf{R}_i[u] = \gamma_i \quad \text{for } i = 1, 2,$$

and we have the GF for \mathbf{L}_x (with homogeneous BCs, of course). We can substitute $v = g(x, y) = G^*(y, x)$ in the generalized Green's identity and use the DE to obtain

$$\int_a^b w(x)G(y, x)f(x) dx - \int_a^b w(x)u(x)(\mathbf{L}_x^\dagger[g])^* dx = Q[u, g^*(x, y)]\Big|_{x=a}^{x=b},$$

or, using $\mathbf{L}_x^\dagger[g(x, y)] = \delta(x - y)/w(y)$,

$$u(y) = \int_a^b w(x)G(y, x)f(x) dx - Q[u, g^*(x, y)]\Big|_{x=a}^{x=b}.$$

To evaluate the surface term, let us write the BCs in matrix form [see Eq. (20.17)]:

$$\begin{aligned} \mathbf{A}u_a + \mathbf{B}u_b = \gamma &\Rightarrow u_b = \mathbf{B}^{-1}\gamma - \mathbf{B}^{-1}\mathbf{A}u_a, \\ \mathbf{A}G_a + \mathbf{B}G_b = 0 &\Rightarrow \mathbf{A}^t(\mathbf{B}^t)^{-1}\mathbf{Q}_b g_b^* + \mathbf{Q}_a g_a^* = 0, \end{aligned}$$

where γ is a column vector composed of γ_1 and γ_2 , and we have assumed that $G(x, y)$ and $g^*(x, y)$ satisfy, respectively, the homogeneous BCs (with $\gamma = 0$) and their adjoints. We have also assumed that the 2×4 matrix of coefficients has rank 2, and without loss of generality, let \mathbf{B} be the invertible 2×2 submatrix. Then, assuming the general form of the surface term as in Eq. (20.15), we obtain

$$\begin{aligned}
 Q[u, g^*(x, y)] \Big|_{x=a}^{x=b} &= u_b^t \mathbf{Q}_b \mathbf{g}_b^* - u_a^t \mathbf{Q}_a \mathbf{g}_a^* \\
 &= (\mathbf{B}^{-1} \gamma - \mathbf{B}^{-1} \mathbf{A} u_a)^t \mathbf{Q}_b \mathbf{g}_b^* - u_a^t \mathbf{Q}_a \mathbf{g}_a^* \\
 &= \gamma^t (\mathbf{B}^t)^{-1} \mathbf{Q}_b \mathbf{g}_b^* - u_a^t \underbrace{[\mathbf{A}^t (\mathbf{B}^t)^{-1} \mathbf{Q}_b \mathbf{g}_b^* + \mathbf{Q}_a \mathbf{g}_a^*]}_{= 0 \text{ because } g^* \text{ satisfies homogeneous adjoint BC}} \\
 &= \gamma^t (\mathbf{B}^t)^{-1} \mathbf{Q}_b \mathbf{g}_b^*, \tag{20.39}
 \end{aligned}$$

where

$$\mathbf{g}_b^* \equiv \begin{pmatrix} g^*(b, y) \\ \frac{\partial}{\partial x} g^*(x, y) \Big|_{x=b} \end{pmatrix} = \begin{pmatrix} G(y, b) \\ \frac{\partial}{\partial x} G(y, x) \Big|_{x=b} \end{pmatrix}.$$

It follows that $Q[u, g^*(x, y)] \Big|_{x=a}^{x=b}$ is given entirely in terms of G , its derivative, the coefficient functions of the DE (hidden in the matrix \mathbf{Q}), the homogeneous BCs (hidden in \mathbf{B}), and the constants γ_1 and γ_2 . The fact that g^* and $\partial g^*/\partial x$ appear to be evaluated at $x = b$ is due to the simplifying (but harmless) assumption that \mathbf{B} is invertible, i.e., that $u(b)$ and $u'(b)$ can be written in terms of $u(a)$ and $u'(a)$. Of course, this may not be possible; then we have to find another pair of the four quantities in terms of the other two, in which case the matrices and the vectors will change but the argument, as well as the conclusion, will remain valid. We can now write

$$u(y) = \int_a^b w(x) G(y, x) f(x) dx - \gamma^t \mathbf{M} \mathbf{g}_b^*, \tag{20.40}$$

where a general matrix \mathbf{M} has been introduced, and the subscript b has been removed to encompass cases where submatrices other than \mathbf{B} are invertible. Equation (20.40) shows that u can be determined completely once we know $G(x, y)$, even though the BCs are inhomogeneous. In practice, there is no need to calculate \mathbf{M} . We can use the expression for $Q[u, g^*]$ obtained from the Lagrange identity of Chap. 14 and evaluate it at b and a . This, in general, involves evaluating u and G and their derivatives at a and b . We know how to handle the evaluation of G because we can actually construct it (if it exists). We next find two of the four quantities corresponding to u in terms of the other two and insert the result in the expression for $Q[u, g^*]$. Equation (20.39) then guarantees that the coefficients of the other two terms will be zero. Thus, we can simply drop all the terms in $Q[u, g^*]$ containing a factor of the other two terms.

Specifically, we use the conjunct for a formally self-adjoint SOLDO [see Eq. (20.26)] and $g^*(x, y) = G(y, x)$ to obtain

$$u(y) = \int_a^b w(x)G(y, x)f(x) dx - \left\{ p(x)w(x) \left[G(y, x) \frac{du}{dx} - u(x) \frac{\partial G}{\partial x}(y, x) \right] \right\}_{x=a}^{x=b}.$$

Interchanging x and y gives

$$u(x) = \int_a^b w(y)G(x, y)f(y) dy + \left\{ p(y)w(y) \left[u(y) \frac{\partial G}{\partial y}(x, y) - G(x, y) \frac{du}{dy} \right] \right\}_{y=a}^{y=b}. \quad (20.41)$$

This equation is valid only for a self-adjoint SOLDO. That is, using it requires casting the SOLDO into a self-adjoint form (a process that is always possible, in light of Theorem 14.5.4).

By setting $f(x) = 0$, we can also obtain the solution to a homogeneous DE $\mathbf{L}_x[u] = 0$ that satisfies the inhomogeneous BCs.

Example 20.3.10 Let us find the solution of the simple DE $d^2u/dx^2 = f(x)$ subject to the simple inhomogeneous BCs $u(a) = \gamma_1$ and $u(b) = \gamma_2$. The GF for this problem has been calculated in Examples 20.1.5 and 20.3.6. Let us begin by calculating the surface term in Eq. (20.41). We have $p(y) = 1$, and we set $w(y) = 1$, then

$$\begin{aligned} \text{surface term} &= u(b) \frac{\partial G}{\partial y} \Big|_{y=b} - G(x, b)u'(b) - u(a) \frac{\partial G}{\partial y} \Big|_{y=a} \\ &\quad + G(x, a)u'(a) \\ &= \gamma_2 \frac{\partial G}{\partial y} \Big|_{y=b} - \gamma_1 \frac{\partial G}{\partial y} \Big|_{y=a} + G(x, a)u'(a) - G(x, b)u'(b). \end{aligned}$$

That the unwanted (and unspecified) terms are zero can be seen by observing that $G(x, a) = g^*(a, x) = (g(a, x))^*$, and that $g(x, y)$ satisfies the BCs adjoint to the homogeneous BCs (obtained when $\gamma_i = 0$). In this particular and simple case, the BCs happen to be self-adjoint (Dirichlet BCs). Thus, $u(a) = u(b) = 0$ implies that $g(a, x) = g(b, x) = 0$ for all $x \in [a, b]$. (In a more general case the coefficient of $u'(a)$ would be more complicated, but still zero.) Thus, we finally have

$$\text{surface term} = \gamma_2 \frac{\partial G}{\partial y} \Big|_{y=b} - \gamma_1 \frac{\partial G}{\partial y} \Big|_{y=a}.$$

Now, using the expression for $G(x, y)$ obtained in Examples 20.1.5 and 20.3.6, we get

$$\frac{\partial G}{\partial y} = -\frac{a-x}{b-a} - \theta(x-y) - \underbrace{(x-y)\delta(x-y)}_{=0} = \frac{x-a}{b-a} - \theta(x-y).$$

Thus,

$$\left. \frac{\partial G}{\partial y} \right|_{y=b} = \frac{x-a}{b-a}, \quad \left. \frac{\partial G}{\partial y} \right|_{y=a} = \frac{x-a}{b-a} - 1 = \frac{x-b}{b-a}.$$

Substituting in Eq. (20.41), we get

$$u(x) = \int_a^b G(x, y) f(y) dy + \frac{\gamma_2 - \gamma_1}{b-a} x + \frac{b\gamma_1 - a\gamma_2}{b-a}.$$

(Compare this with the result obtained in Example 20.1.5.)

Green's functions have a very simple and enlightening physical interpretation. An inhomogeneous DE such as $\mathbf{L}_x[u] = f(x)$ can be interpreted as a black box (\mathbf{L}_x) that determines a physical quantity (u) when there is a source (f) of that physical quantity. For instance, electrostatic potential is a physical quantity whose source is charge; a magnetic field has an electric current as its source; displacements and velocities have forces as their sources; and so forth. Applying this interpretation and assuming that $w(x) = 1$, we have $G(x, y)$ as the physical quantity, evaluated at x when its source $\delta(x - y)$ is located at y . To be more precise, let us say that the strength of the source is S_1 and it is located at y_1 ; then the source becomes $S_1\delta(x - y_1)$. The physical quantity, the Green's function, is then $S_1G(x, y_1)$, because of the linearity of \mathbf{L}_x : If $G(x, y)$ is a solution of $\mathbf{L}_x[u] = \delta(x - y)$, then $S_1G(x, y_1)$ is a solution of $\mathbf{L}_x[u] = S_1\delta(x - y)$. If there are many sources located at $\{y_i\}_{i=1}^N$ with corresponding strengths $\{S_i\}_{i=1}^N$, then the overall source f as a function of x becomes $f(x) = \sum_{i=1}^N S_i\delta(x - y_i)$, and the corresponding physical quantity $u(x)$ becomes $u(x) = \sum_{i=1}^N S_iG(x, y_i)$.

relation of GF to sources

Since the source S_i is located at y_i , it is more natural to define a function $S(x)$ and write $S_i = S(y_i)$. When the number of point sources goes to infinity and y_i becomes a smooth continuous variable, the sums become integrals, and we have

$$f(x) = \int_a^b S(y)\delta(x - y) dy, \quad u(x) = \int_a^b S(y)G(x, y) dy.$$

The first integral shows that $S(x) = f(x)$. Thus, the second integral becomes $u(x) = \int_a^b f(y)G(x, y) dy$ which is precisely what we obtained formally.

20.4 Eigenfunction Expansion

Green's functions are inverses of differential operators. Inverses of operators in a Hilbert space are best studied in terms of resolvents. This is because if an operator \mathbf{A} has an inverse, zero is in its resolvent set, and

$$\mathbf{R}_0(\mathbf{A}) = \mathbf{R}_\lambda(\mathbf{A})|_{\lambda=0} = (\mathbf{A} - \lambda \mathbf{1})^{-1}|_{\lambda=0} = \mathbf{A}^{-1}.$$

Thus, it is instructive to discuss Green's functions in the context of the resolvent of a differential operator. We will consider only the case where the eigenvalues are discrete, for example, when \mathbf{L}_x is a Sturm-Liouville operator.

Formally, we have $(\mathbf{L} - \lambda \mathbf{1})\mathbf{R}_\lambda(\mathbf{L}) = \mathbf{1}$, which leads to the DE

$$(\mathbf{L}_x - \lambda)R_\lambda(x, y) = \frac{\delta(x - y)}{w(x)},$$

where $R_\lambda(x, y) = \langle x | \mathbf{R}_\lambda(\mathbf{L}) | y \rangle$. The DE simply says that $R_\lambda(x, y)$ is the Green's function for the operator $\mathbf{L}_x - \lambda$. So we can rewrite the equation as

$$(\mathbf{L}_x - \lambda)G_\lambda(x, y) = \frac{\delta(x - y)}{w(x)},$$

where $\mathbf{L}_x - \lambda$ is a DO having some homogeneous BCs. The GF $G_\lambda(x, y)$ exists if and only if $(\mathbf{L}_x - \lambda)[u] = 0$ has no nontrivial solution, which is true only if λ is not an eigenvalue of \mathbf{L}_x . We choose the BCs in such a way that \mathbf{L}_x becomes self-adjoint.

Let $\{\lambda_n\}_{n=1}^\infty$ be the eigenvalues of the system $\mathbf{L}_x[u] = \lambda u$, $\{\mathbf{R}_i[u] = 0\}_{i=1}^2$, and let the $u_n^{(k)}(x)$ be the corresponding eigenfunctions. The index k distinguishes among the linearly independent vectors corresponding to the same eigenvalue λ_n . Assuming that \mathbf{L} has compact resolvent (e.g., a Sturm-Liouville operator), these eigenfunctions form a complete set for the subspace of the Hilbert space that consists of those functions that satisfy the same BCs as the $u_n^{(k)}(x)$. In particular, $G_\lambda(x, y)$ can be expanded in terms of $u_n^{(k)}(x)$. The expansion coefficients are, of course, functions of y . Thus, we can write

$$G_\lambda(x, y) = \sum_k \sum_{n=1}^\infty a_n^{(k)}(y) u_n^{(k)}(x)$$

where $a_n^{(k)}(y) = \int_a^b w(x) u_n^{*(k)}(x) G_\lambda(x, y) dx$. Using Green's identity, Eq. (20.30), and the fact that λ_n is real, we have

$$\begin{aligned} \lambda_n a_n^{(k)}(y) &= \int_a^b w(x) [\lambda_n u_n^{(k)}(x)]^* G_\lambda(x, y) dx \\ &= \int_a^b w(x) G_\lambda(x, y) \{\mathbf{L}_x[u_n^{(k)}(x)]\}^* dx \\ &= \int_a^b w(x) [u_n^{(k)}(x)]^* \mathbf{L}_x[G_\lambda(x, y)] dx \end{aligned}$$

$$\begin{aligned}
&= \int_a^b w(x) u_n^{*(k)}(x) \left[\frac{\delta(x-y)}{w(x)} + \lambda G_\lambda(x, y) \right] dx \\
&= u_n^{*(k)}(y) + \lambda \int_a^b w(x) u_n^{*(k)}(x) G_\lambda(x, y) dx \\
&= u_n^{*(k)}(y) + \lambda a_n^{(k)}(y).
\end{aligned}$$

Thus, $a_n^{(k)}(y) = u_n^{*(k)}(y)/(\lambda_n - \lambda)$, and the expansion for the Green's function is

$$G_\lambda(x, y) = \sum_k \sum_{n=1}^{\infty} \frac{u_n^{*(k)}(y) u_n^{(k)}(x)}{\lambda_n - \lambda}. \quad (20.42)$$

This expansion is valid as long as $\lambda_n \neq \lambda$ for any $n = 0, 1, 2, \dots$. But this is precisely the condition that ensures the existence of an inverse for $\mathbf{L} - \lambda \mathbf{1}$.

An interesting result is obtained from Eq. (20.42) if λ is considered a complex variable. In that case, $G_\lambda(x, y)$ has (infinitely many) simple poles at $\{\lambda_n\}_{n=1}^{\infty}$. The residue at the pole λ_n is $-\sum_k u_n^{*(k)}(y) u_n^{(k)}(x)$. If C_m is a contour having the poles $\{\lambda_n\}_{n=1}^m$ in its interior, then, by the residue theorem, we have

$$\frac{1}{2\pi i} \oint_{C_m} G_\lambda(x, y) d\lambda = - \sum_k \sum_{n=1}^m u_n^{*(k)}(y) u_n^{(k)}(x).$$

In particular, if we let $m \rightarrow \infty$, we obtain

$$\begin{aligned}
\frac{1}{2\pi i} \oint_{C_\infty} G_\lambda(x, y) d\lambda &= - \sum_k \sum_{n=1}^{\infty} u_n^{*(k)}(y) u_n^{(k)}(x) \\
&= - \frac{\delta(x-y)}{w(x)},
\end{aligned} \quad (20.43)$$

where C_∞ is any contour that encircles all the eigenvalues, and in the last step we used the completeness of the eigenfunctions. Equation (20.43) is the infinite-dimensional analogue of Eq. (17.10) with $f(\mathbf{A}) = \mathbf{1}$ when the latter equation is sandwiched between $\langle x |$ and $|y \rangle$.

Example 20.4.1 Consider the DO $\mathbf{L}_x = d^2/dx^2$ with BCs $u(0) = u(a) = 0$. This is an S-L operator with eigenvalues and normalized eigenfunctions

$$\lambda_n = \left(\frac{n\pi}{a}\right)^2 \quad \text{and} \quad u_n(x) = \sqrt{\frac{2}{a}} \sin\left(\frac{n\pi}{a}x\right) \quad \text{for } n = 1, 2, \dots$$

Equation (20.42) becomes

$$G_\lambda(x, y) = -\frac{2}{a} \sum_{n=1}^{\infty} \frac{\sin(n\pi x/a) \sin(n\pi y/a)}{\lambda - (n\pi/a)^2},$$

which leads to

$$\begin{aligned}
& \frac{1}{2\pi i} \oint_{C_\infty} G_\lambda(x, y) d\lambda \\
&= \frac{1}{2\pi i} \oint_{C_\infty} \left[-\frac{2}{a} \sum_{n=1}^{\infty} \frac{\sin(n\pi x/a) \sin(n\pi y/a)}{\lambda - (n\pi/a)^2} \right] d\lambda \\
&= -\frac{1}{2\pi i} \left(\frac{2}{a} \right) \sum_{n=1}^{\infty} \sin\left(\frac{n\pi}{a}x\right) \sin\left(\frac{n\pi}{a}y\right) \oint_{C_\infty} \frac{d\lambda}{\lambda - (n\pi/a)^2} \\
&= -\left(\frac{2}{a}\right) \sum_{n=1}^{\infty} \sin\left(\frac{n\pi}{a}x\right) \sin\left(\frac{n\pi}{a}y\right) \operatorname{Res} \left[\frac{1}{\lambda - (n\pi/a)^2} \right]_{\lambda=\lambda_n} \\
&= -\left(\frac{2}{a}\right) \sum_{n=1}^{\infty} \sin\left(\frac{n\pi}{a}x\right) \sin\left(\frac{n\pi}{a}y\right).
\end{aligned}$$

The RHS is recognized as $-\delta(x - y)$.

eigenfunction expansion
of GF

If zero is not an eigenvalue of \mathbf{L}_x , Eq. (20.42) yields

$$G(x, y) \equiv G_0(x, y) = \sum_k \sum_{n=1}^{\infty} \frac{u_n^{*(k)}(y) u_n^{(k)}(x)}{\lambda_n}, \quad (20.44)$$

which is an expression for the Green's function of \mathbf{L}_x in terms of its eigenvalues and eigenfunctions.

20.5 Problems

20.1 Using the GF method, solve the DE $\mathbf{L}_x u(x) = du/dx = f(x)$ subject to the BC $u(0) = a$. Hint: Consider the function $v(x) = u(x) - a$.

20.2 Solve the problem of Example 20.1.4 subject to the BCs $u(a) = u'(a) = 0$. Show that the corresponding GF also satisfies these BCs.

20.3 Show that the IVP with data $\{0; 0, 0, \dots, 0\}$ has only $u \equiv 0$ as a solution. Hint: Assume otherwise, add u to the solution of the inhomogeneous equation, and invoke uniqueness.

exact NOLDE **20.4** In this problem, we generalize the concepts of exactness and integrating factor to a NOLDE. The DO $\mathbf{L}_x^{(n)} \equiv \sum_{k=0}^n p_k(x) d^k/dx^k$ is said to be **exact** if there exists a DO $\mathbf{M}_x^{(n-1)} \equiv \sum_{k=0}^{n-1} a_k(x) d^k/dx^k$ such that

$$\mathbf{L}_x^{(n)}[u] = \frac{d}{dx} (\mathbf{M}_x^{(n-1)}[u]) \quad \forall u \in \mathcal{C}^n[a, b].$$

(a) Show that $\mathbf{L}_x^{(n)}$ is exact iff $\sum_{m=0}^n (-1)^m d^m p_m/dx^m = 0$.

- (b) Show that there exists an integrating factor for $\mathbf{L}_x^{(n)}$ —that is, a function $\mu(x)$ such that $\mu(x)\mathbf{L}_x^{(n)}$ is exact—if and only if $\mu(x)$ satisfies the DE

$$\mathbf{N}_x^{(n)}[\mu] \equiv \sum_{m=0}^n (-1)^m \frac{d^m}{dx^m} (\mu p_m) = 0.$$

The DO $\mathbf{N}_x^{(n)}$ is the formal adjoint of $\mathbf{L}_x^{(n)}$.

20.5 Let \mathbf{L}_x be a SOLDO. Assuming that $\mathbf{L}_x[u] = 0$ has no nontrivial solution, show that the matrix

$$\mathbf{R} \equiv \begin{pmatrix} \mathbf{R}_1[u_1] & \mathbf{R}_1[u_2] \\ \mathbf{R}_2[u_1] & \mathbf{R}_2[u_2] \end{pmatrix},$$

where u_1 and u_2 are independent solutions of $\mathbf{L}_x[u] = 0$ and \mathbf{R}_i are the boundary functionals, has a nonzero determinant. Hint: Assume otherwise and show that the system of homogeneous linear equations $\alpha\mathbf{R}_1[u_1] + \beta\mathbf{R}_1[u_2] = 0$ and $\alpha\mathbf{R}_2[u_1] + \beta\mathbf{R}_2[u_2] = 0$ has a nontrivial solution for (α, β) . Reach a contradiction by considering $u = \alpha u_1 + \beta u_2$ as a solution of $\mathbf{L}_x[u] = 0$.

20.6 Determine the formal adjoint of each of the operators in (a) through (d) below (i) as a differential operator, and (ii) as an operator, that is, including the BCs. Which operators are formally self-adjoint? Which operators are self-adjoint?

- (a) $\mathbf{L}_x = d^2/dx^2 + 1$ in $[0, 1]$ with BCs $u(0) = u(1) = 0$.
 (b) $\mathbf{L}_x = d^2/dx^2$ in $[0, 1]$ with BCs $u(0) = u'(0) = 0$.
 (c) $\mathbf{L}_x = d/dx$ in $[0, \infty]$ with BCs $u(0) = 0$.
 (d) $\mathbf{L}_x = d^3/dx^3 - \sin x d/dx + 3$ in $[0, \pi]$ with BCs $u(0) = u'(0) = 0$, $u''(0) - 4u(\pi) = 0$.

20.7 Show that the Dirichlet, Neumann, general unmixed, and periodic BCs make the following formally self-adjoint SOLDO self-adjoint:

$$\mathbf{L}_x = \frac{1}{w} \frac{d}{dx} \left(p \frac{d}{dx} \right) + q.$$

20.8 Using a procedure similar to that described in the text for SOLDOs, show that for the FOLDO $\mathbf{L}_x = p_1 d/dx + p_0$

- (a) the indefinite GF is

$$G(x, y) \equiv \frac{\mu(y)}{p_1(y)w(y)} \left[\frac{\theta(x-y)}{\mu(x)} \right] + C(y),$$

$$\text{where } \mu(x) = \exp \left[\int^x \frac{p_0(t)}{p_1(t)} dt \right],$$

- (b) and the GF itself is discontinuous at $x = y$ with

$$\lim_{\epsilon \rightarrow 0} [G(y + \epsilon, y) - G(y - \epsilon, y)] = \frac{1}{p_1(y)w(y)}.$$

(c) For the homogeneous BC

$$\mathbf{R}[u] \equiv \alpha_1 u(a) + \alpha_2 u'(a) + \beta_1 u(b) + \beta_2 u'(b) = 0$$

construct $G(x, y)$ and show that

$$G(x, y) = \frac{1}{p_1(y)w(y)v(y)} v(x)\theta(x-y) + C(y)v(x),$$

where $v(x)$ is any solution to the homogeneous DE $\mathbf{L}_x[u] = 0$ and

$$C(y) = \frac{\beta_1 v(b) + \beta_2 v'(b)}{\mathbf{R}[v]p_1(y)w(y)v(y)}, \quad \text{with } \mathbf{R}[v] \neq 0$$

(d) Show directly that $\mathbf{L}_x[G] = \delta(x-y)/w(x)$.

20.9 Let \mathbf{L}_x be a NOLDO with constant coefficients. Show that if $u(x)$ satisfies $\mathbf{L}_x[u] = f(x)$, then $u(x-y)$ satisfies $\mathbf{L}_x[u] = f(x-y)$. (Note that no BCs are specified.)

20.10 Find the GF for $\mathbf{L}_x = d^2/dx^2 + 1$ with BCs $u(0) = u'(0) = 0$. Show that it can be written as a function of $x-y$ only.

20.11 Find the GF for $\mathbf{L}_x = d^2/dx^2 + k^2$ with BCs $u(0) = u(a) = 0$.

20.12 Find the GF for $\mathbf{L}_x = d^2/dx^2 - k^2$ with BCs $u(\infty) = u(-\infty) = 0$.

20.13 Find the GF for $\mathbf{L}_x = (d/dx)(xd/dx)$ given the condition that $G(x, y)$ is finite at $x=0$ and vanishes at $x=1$.

20.14 Evaluate the GF and the solutions for each of the following DEs in the interval $[0, 1]$.

(a) $u'' - k^2 u = f; \quad u(0) - u'(0) = a, \quad u(1) = b.$

(b) $u'' = f; \quad u(0) = u'(0) = 0.$

(c) $u'' + 6u' + 9u = 0; \quad u(0) = 0, \quad u'(0) = 1.$

(d) $u'' + \omega^2 u = f(x), \quad \text{for } x > 0; \quad u(0) = a, \quad u'(0) = b.$

(e) $u^{(4)} = f; \quad u(0) = 0, \quad u'(0) = 2u'(1), \quad u(1) = a, \quad u''(0) = 0.$

20.15 Use eigenfunction expansion of the GF to solve the BVP $u'' = x$, $u(0) = 0$, $u(1) - 2u'(1) = 0$.

The extensive study of Green's functions in one dimension in the last chapter has no doubt exhibited the power and elegance of their use in solving inhomogeneous differential equations. If the differential equation has a (unique) solution, the GF exists and contains all the information necessary to build it up. The solution results from operating on the inhomogeneous term with an integral operator whose kernel is the appropriate Green's function.

The Green's function's very existence depends on the type of BCs imposed. We encountered two types of problems in solving ODEs. The first, called initial value problems (IVPs), involves fixing (for an n th-order DE) the value of the solution and its first $n - 1$ derivatives at a fixed point. Then the ODE, if it is sufficiently well-behaved, will determine the values of the solution in the neighborhood of the fixed point in a unique way. Because of this uniqueness, Green's functions always exist for IVPs.

The second type of problems, called boundary value problems (BVPs), consists—when the DE is second order—of determining a relation between the solution and its derivative evaluated at the boundaries of some interval $[a, b]$. These boundary values are relations that we denoted by $\mathbf{R}_i[u] = \gamma_i$, where $i = 1, 2$. In this case, the existence and uniqueness of the Green's function are not guaranteed.

There is a fundamental (topological) difference between a boundary in one dimension and a boundary in two and more dimensions. In one dimension a boundary consists of *only two points*; in 2 and higher dimensions a boundary has *infinitely many points*. The boundary of a region in \mathbb{R}^2 is a closed curve, in \mathbb{R}^3 it is a closed surface, and in \mathbb{R}^m it is called a **hypersurface**. This fundamental difference makes the study of Green's functions in higher dimensions more complicated, but also richer and more interesting.

21.1 Properties of Partial Differential Equations

This section presents certain facts and properties of PDEs, in particular, how BCs affect their solutions. We shall discover the important difference between ODEs and PDEs: The existence of a solution to a PDE satisfying a given BC depends on the type of the PDE.

We shall be concerned exclusively with a linear PDE. A linear PDE of order M in m variables is of the form

$$\mathbf{L}_x[u] = f(\mathbf{x}) \quad \text{where} \quad \mathbf{L}_x = \sum_{|J|=1}^M \sum_J a_J(\mathbf{x}) \frac{\partial^{|J|}}{\partial \mathbf{x}^J}, \quad (21.1)$$

where the following notation has been used:

$$\begin{aligned} \mathbf{x} &= (x_1, \dots, x_m), & J &= (j_1, \dots, j_m), \\ |J| &= j_1 + j_2 + \dots + j_m, & \frac{\partial^{|J|}}{\partial \mathbf{x}^J} &= \frac{\partial^{|J|}}{\partial x_1^{j_1} \partial x_2^{j_2} \dots \partial x_m^{j_m}}; \end{aligned}$$

the j_k are nonnegative integers; M , the order of the highest derivative, is called the **order** of the PDE. The outer sum in Eq. (21.1) is over $|J|$; once $|J|$ is fixed, the inner summation goes over individual j_k 's with the restriction that their sum has to equal the given $|J|$.

principal part of a PDE The **principal part** of \mathbf{L}_x is

$$\mathbf{L}_p = \sum_{|J|=M} a_J(x_1, \dots, x_m) \frac{\partial^M}{\partial \mathbf{x}^J}. \quad (21.2)$$

The coefficients a_J and the inhomogeneous (or source) term f are assumed to be continuous functions of their arguments.

Cauchy data and Cauchy problem We consider Eq. (21.1) as an IVP with appropriate initial data. The most direct generalization of the IVP of ordinary differential equation theory is to specify the values of u and all its *normal derivatives* of order less than or equal to $M - 1$ on a hypersurface Γ of dimension $m - 1$. This type of initial data is called **Cauchy data**, and the resulting IVP is known as the **Cauchy problem** for \mathbf{L}_x . The reason that the tangential derivatives do not come into play here is that once we know the values of u on Γ , we can evaluate u on two neighboring points on Γ , take the limit as the points get closer and closer, and evaluate the tangential derivatives.

21.1.1 Characteristic Hypersurfaces

In contrast to the IVP in one dimension, the Cauchy problem for arbitrary Cauchy data may not have a solution, or if it does, the solution may not be unique.

Box 21.1.1 *The existence and uniqueness of the solution of the Cauchy problem depend crucially on the hypersurface Γ and on the type of PDE.*

We assume that Γ can be parametrized by a set of m functions of $m - 1$ parameters. These parameters can be thought of as generalized coordinates of points of Γ .

Consider a point P on Γ . Introduce $m - 1$ coordinates ξ_2, \dots, ξ_m , called **tangential coordinates**, to label points on Γ . Choose, by translation if necessary, coordinates in such a way that P is the origin, with coordinates $(0, 0, \dots, 0)$. Now let $v = \xi_1$ stand for the remaining coordinate normal to Γ . Usually ξ_i is taken to be the i th coordinate of the projection of the point on Γ onto the hyperplane tangent to Γ at P .

tangential coordinates

As long as we do not move too far away from P , the Cauchy data on Γ can be written as

$$u(0, \xi_2, \dots, \xi_m), \quad \frac{\partial u}{\partial v}(0, \xi_2, \dots, \xi_m), \dots, \quad \frac{\partial^{M-1} u}{\partial v^{M-1}}(0, \xi_2, \dots, \xi_m).$$

Using the chain rule, $\partial u / \partial x_i = \sum_{j=1}^m (\partial u / \partial \xi_j)(\partial \xi_j / \partial x_i)$, where $\xi_1 = v$, we can also determine the first $M - 1$ derivatives of u with respect to x_i . The fundamental question is whether we can determine u uniquely using the above Cauchy data and the DE. To motivate the answer, let's look at the analogous problem in one dimension.

Consider the M th-order linear ODE

$$\mathbf{L}_x[u] = a_M(x) \frac{d^M u}{dx^M} + \dots + a_1(x) \frac{du}{dx} + a_0(x)u = f(x) \quad (21.3)$$

with the following initial data at x_0 : $\{u(x_0), u'(x_0), \dots, u^{(M-1)}(x_0)\}$. If the coefficients $\{a_k(x)\}_{k=0}^M$ and the inhomogeneous term $f(x)$ are continuous and if $a_M(x_0) \neq 0$, then Theorem 20.2.2 implies that there exists a unique solution to the IVP in a neighborhood of x_0 .

For $a_M(x_0) \neq 0$, Eq. (21.3), the initial data, and a knowledge of $f(x_0)$ give $u^{(M)}(x_0)$ uniquely. Having found $u^{(M)}(x_0)$, we can calculate, with arbitrary accuracy (by choosing Δx small enough), the following set of *new* initial data at $x_1 = x_0 + \Delta x$:

$$u(x_1) = u(x_0) + u'(x_0)\Delta x, \dots, u^{(M-1)}(x_1) = u^{(M-1)}(x_0) + u^{(M)}(x_0)\Delta x.$$

Using these new initial data and Theorem 20.2.2, we are assured of a unique solution at x_1 . Since $a_M(x)$ is assumed to be continuous for x_1 , for sufficiently small Δx , $a_M(x_0)$ is nonzero, and it is possible to find newer initial data at $x_2 = x_1 + \Delta x$. The process can continue until we reach a singularity of the DE, a point where $a_M(x)$ vanishes. We can thus construct the unique solution of the IVP in an interval (x_0, b) as long as $a_M(x)$ does not vanish anywhere in $[x_0, b]$. This procedure is analogous to the one used in the analytic continuation of a complex function.

For $a_M(x_0) = 0$, however, we cannot calculate $u^{(M)}(x_0)$ unambiguously. In such a case the LHS of (21.3) is completely determined from the initial data. If the LHS happens to be equal to $f(x_0)$, then the equation is satisfied for *any* $u^{(M)}(x_0)$, i.e., there exist infinitely many solutions for $u^{(M)}(x_0)$; if the LHS is not equal to $f(x_0)$, there are no solutions. The difficulty can be stated in another way, which is useful for generalization to the m -dimensional case: If $a_M(x_0) = 0$ in (21.3), then the initial data determine the function $\mathbf{L}_x[u]$.

Let us now return to the question of constructing u and investigate conditions under which the Cauchy problem may have a solution. We follow the same steps as for the IVP for ODEs. To construct the solution numerically for points near P but away from Γ (since the function is completely determined on Γ , not only its M th derivative but derivatives of all orders are known on Γ), we must be able to calculate $\partial^M u / \partial v^M$ at P . This is not possible if the coefficient of $\partial^M u / \partial v^M$ in $\mathbf{L}_x[u]$ is zero when x_1, \dots, x_m is written in terms of v, ξ_2, \dots, ξ_m . When this happens, $\mathbf{L}_x[u]$ itself will be determined by the Cauchy data. This motivates the following definition.

Definition 21.1.2 If $\mathbf{L}_x[u]$ can be evaluated at a point P on Γ from the characteristic hypersurface Cauchy data alone, then Γ is said to be **characteristic** for \mathbf{L}_x at P . If Γ is characteristic for all its points, then it is called a **characteristic hypersurface** for \mathbf{L}_x . The Cauchy problem does not have a solution at a point on the characteristic hypersurface.

The following theorem characterizes Γ :

Theorem 21.1.3 Let Γ be a smooth $(m - 1)$ -dimensional hypersurface. Let $\mathbf{L}_x[u] = f$ be an M th-order linear PDE in m variables. Then Γ is characteristic at $P \in \Gamma$ if and only if the coefficient of $\partial^M u / \partial v^M$ vanishes when \mathbf{L}_x is expressed in terms of the normal-tangential coordinate system (v, ξ_2, \dots, ξ_m) .

One can rephrase the foregoing theorem as follows:

Box 21.1.4 The hypersurface Γ is not characteristic at P if and only if all M th-order partial derivatives of u with respect to $\{x_i\}_{i=1}^m$ are unambiguously determined at P by the DE and the Cauchy data on Γ .

In the one-dimensional case the difficulty arose when $a_M(x_0) = 0$. In the language being used here, we could call x_0 a “characteristic point.” This makes sense because in this special case ($m = 1$), the hypersurfaces can only be of dimension 0. Thus, we can say that in the neighborhood of a characteristic point, the IVP has no well-defined solution.¹ For the general case ($m > 1$), we can similarly say that the Cauchy problem has no well-defined solution in the neighborhood of P if P happens to lie on a characteristic hypersurface of the differential operator. Thus, it is important to determine the characteristic hypersurfaces of PDEs.

Characteristic “hypersurfaces” of ODEs are points!

Example 21.1.5 Let us consider the first-order PDE in two variables

$$\mathbf{L}_x[u] = a(x, y) \frac{\partial u}{\partial x} + b(x, y) \frac{\partial u}{\partial y} + F(x, y, u) = 0 \tag{21.4}$$

¹Here lies the crucial difference between ODEs and PDEs: All ODEs have a universal characteristic hypersurface, i.e., a point. PDEs, on the other hand, can have a variety of hypersurfaces.

where $F(x, y, u) \equiv c(x, y)u + d(x, y)$. For this discussion the form of F is irrelevant.

We wish to find the characteristic hypersurfaces (in this case, curves) of \mathbf{L} . The Cauchy data consist of a simple determination of u on Γ . By Theorem 21.1.3, we need to derive relations that ensure that $\partial u/\partial x$ and $\partial u/\partial y$ cannot be unambiguously determined at $P = (x, y)$. Using an obvious notation, the PDE of Eq. (21.4) gives

$$-F(P, u(P)) = a(P) \frac{\partial u}{\partial x}(P) + b(P) \frac{\partial u}{\partial y}(P).$$

On the other hand, if $Q \equiv (x + dx, y + dy)$ lies on the curve Γ , then

$$u(Q) - u(P) = dx \frac{\partial u}{\partial x}(P) + dy \frac{\partial u}{\partial y}(P).$$

The Cauchy data determine the LHS of both of the preceding equations. Treating these equations as a system of two linear equations in two unknowns, $\partial u/\partial x(P)$ and $\partial u/\partial y(P)$, we conclude that the system has a unique solution if and only if the matrix of coefficients is invertible. Thus, by Box 21.1.4, Γ is a characteristic curve if and only if

$$\det \begin{pmatrix} dx & dy \\ a(P) & b(P) \end{pmatrix} = b(P) dx - a(P) dy = 0,$$

or $dy/dx = b(x, y)/a(x, y)$, assuming that $a(x, y) \neq 0$. Solving this FODE yields y as a function of x , thus determining the characteristic curve. Note that a general solution of this FODE involves an arbitrary constant, resulting in a family of characteristic curves.

Historical Notes

Sofia Vasilyevna Kovalevskaya (1850–1891) is considered the greatest woman mathematician prior to the twentieth century. She grew up in a well-educated family of the Russian nobility, her father being an artillery general and reputed to be a descendant of a Hungarian king, Mathias Korvin. Sonja was educated by a British governess and enjoyed life at the large country estate of her father's family, although the rather progressive thinking of the Kovalevsky sisters did not always meet with approval from their father.

Sonja has written of two factors that attracted her to the study of mathematics. The first was her Uncle Pyotr, who had studied the subject on his own and would speak of squaring the circle and of the asymptote, as well as of many other things that excited her imagination. The second was a curious “wallpaper” that was used to cover one of the children's rooms at Polibino, which turned out to be lecture notes on differential and integral calculus that had been purchased by her father in student days. These sheets fascinated her and she would spend hours trying to decipher separate phrases and to find the proper ordering of the pages.

In the autumn of 1867 Sonja went to St. Petersburg, where she studied calculus with Alexander Strannolyubsky, a teacher of mathematics at the naval school. While there, she consulted the prominent Russian mathematician Chebyshev about her mathematical studies, but since Russian universities were closed to women, there seemed to be no way that she could pursue advanced studies in her native land.

In order to escape the oppression of women common in Russia at the time, young ladies of ambition and ability would often arrange a marriage of convenience in order to allow study at a foreign university. At the age of 18, Sonya arranged such a marriage with Vladimir Kovalevsky, a paleontologist, and in 1869 the couple moved to Heidelberg, where Sonja took courses from Kirchhoff, Helmholtz, and others. Two years later



Sofia Vasilyevna
Kovalevskaya 1850–1891

she went to Berlin, where she worked with Weierstrass, who tutored her privately, since she, as a woman, was not allowed to attend lectures.

The three papers she published in the next three years earned her a doctorate in absentia from the University of Göttingen. Unfortunately, even that distinction was not sufficient to gain her a university position anywhere in Europe, despite strong recommendation from the renowned Weierstrass. Her rejections resulted in a six-year period during which time she neither undertook research nor replied to Weierstrass's letters. She was bitter to discover that the best job she was offered was teaching arithmetic to elementary classes of schoolgirls, and remarked, "I was unfortunately weak in the multiplication table."

The existence and uniqueness of solutions to partial differential equations occupied the attention of many notable mathematicians of the last century, including Cauchy, who transformed the problem into his *method of majorant functions*. This method was later extended and refined by Kovalevskaya to include more general cases. The result was the now-famous *Cauchy–Kovalevskaya theorem*. She also contributed to the advancement of the study of Abelian integrals and functions and applied her knowledge of these topics to problems in physics, including her paper "On the Rotation of a Solid Body About a Fixed Point," for which she won a 5000-franc prize. She also performed some investigations into the dynamics of Saturn's rings, inspiring a sonnet in which she is named "Muse of the Heavens." In 1878, Kovalevskaya gave birth to a daughter, but from 1880 increasingly returned to her study of mathematics. In 1882 she began work on the refraction of light, and wrote three articles on the topic. In the spring of 1883, Vladimir, from whom Sonja had been separated for two years, committed suicide. After the initial shock, Kovalevskaya immersed herself in mathematical work in an attempt to rid herself of feelings of guilt. Mittag-Leffler managed to overcome opposition to Kovalevskaya in Stockholm, and obtained for her a position as privat docent. She began to lecture there in early 1884, was appointed to a five-year extraordinary professorship in June of that year, and in June 1889 became the third woman ever to hold a chair at a European university.

During Kovalevskaya's years at Stockholm she carried out important research, taught courses on the latest topics in analysis, and became an editor of the new journal *Acta Mathematica*. She was the liaison with the mathematicians of Paris and Berlin, and took part in the organization of international conferences. Interestingly, Kovalevskaya also nurtured a parallel career in literature, penning several novels and a drama, "The Struggle for Happiness" that was favorably received at the Korsh Theater in Moscow. She died at the pinnacle of her scientific career from a combination of influenza and pneumonia less than two years after her election to both the Swedish and the Russian Academies of Sciences. The latter membership being initiated by Chebyshev, in spite of the Tsarist government's repeated refusal to grant her a university position in her own country.

21.1.2 Second-Order PDEs in m Dimensions

Because of their importance in mathematical physics, the rest of this chapter and the next will be devoted to SOPDEs. This subsection classifies SOPDEs and the BCs associated with them.

The most general linear SOPDE in m variables can be written as

$$\sum_{j,k=1}^m A_{jk}(\mathbf{x}) \frac{\partial^2 u}{\partial x_j \partial x_k} + \sum_{j=1}^m B_j(\mathbf{x}) \frac{\partial u}{\partial x_j} + C(\mathbf{x})u = 0,$$

where A_{jk} can be assumed to be symmetric in j and k . We restrict ourselves to the simpler case in which the matrix (A_{jk}) is diagonal.² We therefore

²This is not a restriction because, by a change of variables and Theorem 6.6.6 (especially the comments after it) A_{jk} can be brought to a diagonal form.

consider the PDE

$$\sum_{j=1}^m a_j(\mathbf{x}) \frac{\partial^2 u}{\partial x_j^2} + F\left(\mathbf{x}, u, \frac{\partial u}{\partial \mathbf{x}}\right), \tag{21.5}$$

where the last term collects all the terms except the second derivatives. We classify SOPDEs as follows:

- | | |
|---|--|
| <ol style="list-style-type: none"> 1. Equation (21.5) is said to be of elliptic type at \mathbf{x}_0 if all the coefficients $a_j(\mathbf{x}_0)$ are nonzero and have the same sign. 2. Equation (21.5) is said to be of ultrahyperbolic type at \mathbf{x}_0 if all $a_j(\mathbf{x}_0)$ are nonzero but do not have the same sign. If only one of the coefficients has a sign different from the rest, the equation is said to be of hyperbolic type. 3. Equation (21.5) is said to be of parabolic type at \mathbf{x}_0 if at least one of the coefficients $a_j(\mathbf{x}_0)$ is zero. | <p>second-order PDE of elliptic type</p> <p>second-order PDEs of hyperbolic and ultrahyperbolic type</p> <p>second-order PDE of parabolic type</p> |
|---|--|

If a SOPDE is of a given type at every point of its domain, it is said to be of that given type. In particular, if the coefficients a_j are constants, the type of the PDE does not change from point to point.

Example 21.1.6 In this example, we study the SOPDE in two dimensions. The most general linear SOPDE is

$$\mathbf{L}[u] = a \frac{\partial^2 u}{\partial x^2} + 2b \frac{\partial^2 u}{\partial x \partial y} + c \frac{\partial^2 u}{\partial y^2} + F\left(x, y, u, \frac{\partial u}{\partial x}, \frac{\partial u}{\partial y}\right) = 0, \tag{21.6}$$

where $a, b,$ and c are functions of x and y .

To determine the characteristic curves of \mathbf{L} , we seek conditions under which all second-order partial derivatives of u can be determined from the DE and the Cauchy data, which are values of u and all its first derivatives on Γ . Consider a point $Q \equiv (x + dx, y + dy)$ close to $P \equiv (x, y)$. We can write

$$\begin{aligned} \frac{\partial u}{\partial x}(Q) - \frac{\partial u}{\partial x}(P) &= dx \frac{\partial^2 u}{\partial x^2}(P) + dy \frac{\partial^2 u}{\partial x \partial y}(P), \\ \frac{\partial u}{\partial y}(Q) - \frac{\partial u}{\partial y}(P) &= dx \frac{\partial^2 u}{\partial x \partial y}(P) + dy \frac{\partial^2 u}{\partial y^2}(P), \\ -F\left(P, u(P), \frac{\partial u}{\partial x}(P), \frac{\partial u}{\partial y}(P)\right) &= a(P) \frac{\partial^2 u}{\partial x^2}(P) + 2b(P) \frac{\partial^2 u}{\partial x \partial y}(P) \\ &\quad + c(P) \frac{\partial^2 u}{\partial y^2}(P). \end{aligned}$$

This system of three linear equations in the three unknowns—the three second derivatives evaluated at P —has a unique solution if and only if the determinant of the coefficients is nonzero. Thus, by Box 21.1.4, Γ is a char-

acteristic curve if and only if

$$\det \begin{pmatrix} dx & dy & 0 \\ 0 & dx & dy \\ a(P) & 2b(P) & c(P) \end{pmatrix} = 0,$$

or $a(x, y)(dy)^2 - 2b(x, y)dxdy + c(x, y)(dx)^2 = 0$. It then follows, assuming that $a(x, y) \neq 0$, that

$$\frac{dy}{dx} = \frac{b \pm \sqrt{b^2 - ac}}{a}. \quad (21.7)$$

There are three cases to consider:

- ill-posed Cauchy problem
1. If $b^2 - ac < 0$, Eq. (21.7) has no solution, which implies that no characteristic curves exist at P . Problem 21.1 shows that the SOPDE is of elliptic type. Thus, the Laplace equation in two dimensions is elliptic because $b^2 - ac = -1$. In fact, it is elliptic in the whole plane, or, stated differently, it has no characteristic curve in the entire xy -plane. This may lead us to believe that the Cauchy problem for the Laplace equation in two dimensions has a unique solution. However, even though the absence of a characteristic hypersurface at P is a necessary condition for the existence of a solution to the Cauchy problem, it is not sufficient. Problem 21.4 presents a Cauchy problem that is **ill-posed**, meaning that the solution at any fixed point is not a continuous function of the initial data. Satisfying this continuity condition is required of a well-posed problem on both mathematical and physical grounds.
 2. If $b^2 - ac > 0$, Eq. (21.7) has two solutions; that is, there are two characteristic curves passing through P . Problem 21.1 shows that the SOPDE is of hyperbolic type. The wave equation is such an equation in the entire \mathbb{R}^2 .
 3. If $b^2 - ac = 0$, Eq. (21.7) has only one solution. In this case there is only one characteristic curve at P . The SOPDE is parabolic in this case. The one-dimensional diffusion equation is an example of an SOPDE that is parabolic in the entire \mathbb{R}^2 .

appropriate BCs are determined by the type of PDE

The question of what type of BCs to use to obtain a unique solution for a PDE is a very intricate mathematical problem. As Problem 21.4 shows, even though it has no characteristic curves in the entire \mathbb{R}^2 , the two-dimensional Laplace equation does not lead to a well-posed Cauchy problem. On the other hand, examples in Chap. 19 that dealt with electrostatic potentials and temperatures led us to believe that a specification of the solution u on a *closed* curve in 2D, and a closed surface in 3D, gives a unique solution. This has a sound physical basis. After all, specifying the temperature (or electrostatic potential) on a closed surface should be enough to give us information about the temperature (or electrostatic potential) in the region close to the curve.

Dirichlet boundary condition and boundary value problem

Definition 21.1.7 A boundary condition in which the value of the solution is given on a closed hypersurface is called a **Dirichlet boundary condition**, and the associated problem, a **Dirichlet BVP**.

There is another type of BC, which on physical grounds is appropriate for the Laplace equation. This condition is based on the fact that if the surface charge on a conductor is specified, then the electrostatic potential in the vicinity of the conductor can be determined uniquely. The surface charge on a conductor is proportional to the value of the electric field on the conductor. The electric field, on the other hand, is the normal derivative of the potential.

Definition 21.1.8 A boundary condition in which the value of the normal derivative of the solution is specified on a closed hypersurface is called a **Neumann BC**, and the associated problem, a **Neumann boundary value problem**.

Neumann boundary condition and boundary value problem

Thus, at least on physical grounds, either a Dirichlet BVP or a Neumann BVP is a well-posed problem for the Laplace equation.

For the heat (or diffusion) equation we are given an initial temperature distribution $f(x)$ on a bar along, say the x -axis, with end points held at constant temperatures. For a bar with end points at $x = a$ and $x = b$, this is equivalent to the data $u(0, x) = f(x)$, $u(t, a) = T_1$, and $u(t, b) = T_2$. These are not Cauchy data, so we need not worry about characteristic curves. The boundary curve consists of three parts: (1) $t = 0$ for $a \leq x \leq b$, (2) $t > 0$ for $x = a$, and (3) $t > 0$, for $x = b$. In the xt -plane, these form an open rectangle consisting of \overline{ab} as one side and vertical lines at a and b as the other two. The problem is to determine u on the side that closes the rectangle, that is, on the side $a \leq x \leq b$ at $t > 0$.

The wave equation requires specification of both u and $\partial u / \partial t$ at $t = 0$. The displacement of the boundaries of the waving medium—a taut rope for example—must also be specified. Again the curve is open, as for the diffusion case, but the initial data are Cauchy. Thus, for the wave equation we do have a Cauchy problem with Cauchy data specified on an open curve. Since the curve, the open rectangle, is not a characteristic curve of the wave equation, the Cauchy problem is well-posed. We can generalize these BCs to m dimensions.

Boundary conditions for elliptic, hyperbolic, and parabolic PDEs

Box 21.1.9 *The following correspondences exist between SOPDEs with m variables and their appropriate BCs:*

1. *Elliptic SOPDE \leftrightarrow Dirichlet or Neumann BCs on a closed hypersurface.*
2. *Hyperbolic SOPDE \leftrightarrow Cauchy data on an open hypersurface.*
3. *Parabolic SOPDE \leftrightarrow Dirichlet or Neumann BCs on an open hypersurface.*

21.2 Multidimensional GFs and Delta Functions

This section will discuss some of the characteristics of Green's functions in higher dimensions. These characteristics are related to the formal partial

differential operator associated with the Green's function and also to the delta functions.

Using the formal idea of several continuous indices, we can turn the operator equation $\mathbf{L}\mathbf{G} = \mathbf{1}$ into the PDE

$$\mathbf{L}_x G(\mathbf{x}, \mathbf{y}) = \frac{\delta(\mathbf{x} - \mathbf{y})}{w(\mathbf{x})}, \quad (21.8)$$

where $\mathbf{x}, \mathbf{y} \in \mathbb{R}^m$, $w(\mathbf{x})$ is a weight function that is usually set equal to one, and, *only in Cartesian coordinates*,

$$\delta(\mathbf{x} - \mathbf{y}) = \delta(x_1 - y_1)\delta(x_2 - y_2)\cdots\delta(x_m - y_m) = \prod_{i=1}^m \delta(x_i - y_i). \quad (21.9)$$

In most applications Cartesian coordinates are not the most convenient to use. Therefore, it is helpful to express Eqs. (21.8) and (21.9) in other coordinate systems. In particular, it is helpful to know how the delta function transforms under a general coordinate transformation.

Let $x_i = f_i(\xi_1, \dots, \xi_m)$, $i = 1, 2, \dots, m$, be a coordinate transformation. Let P be a point whose coordinates are $\mathbf{a} = (a_1, \dots, a_m)$ and $\boldsymbol{\alpha} = (\alpha_1, \dots, \alpha_m)$ in the x and ξ coordinate systems, respectively. Let J be the Jacobian of the transformation, that is, the absolute value of the determinant of a matrix whose elements are $\partial x_i / \partial \xi_j$. For a function $F(\mathbf{x})$ the definition of the delta function gives

$$\int d^m x F(\mathbf{x}) \delta(\mathbf{x} - \mathbf{a}) = F(\mathbf{a}).$$

Expressing this equation in terms of the ξ coordinate system, recalling that $d^m x = J d^m \xi$ and $a_i = f_i(\boldsymbol{\alpha})$, and introducing the notation $H(\boldsymbol{\xi}) \equiv F(f_1(\boldsymbol{\xi}), \dots, f_m(\boldsymbol{\xi}))$, we obtain

$$\int d^m \xi J H(\boldsymbol{\xi}) \prod_{i=1}^m \delta(f_i(\boldsymbol{\xi}) - f_i(\boldsymbol{\alpha})) = H(\boldsymbol{\alpha}). \quad (21.10)$$

This suggests that

$$J \prod_{i=1}^m \delta(f_i(\boldsymbol{\xi}) - f_i(\boldsymbol{\alpha})) = \prod_{i=1}^m \delta(\xi_i - \alpha_i),$$

or, in more compact notation,

$$J \delta(\mathbf{x} - \mathbf{a}) = \delta(\boldsymbol{\xi} - \boldsymbol{\alpha}).$$

It is, of course, understood that $J \neq 0$ at P . What happens when $J = 0$ at P ?

singular point of a
transformation

A point at which the Jacobian vanishes is called a **singular point** of the transformation. Thus, all points on the z -axis, including the origin, are singular points of Cartesian–spherical transformation. Since J is a determinant, its vanishing at a point signals lack of invertibility at that point. Thus, in the transformation from Cartesian to spherical coordinates, all spherical coordinates $(5, \pi, \varphi)$, with arbitrary φ , are mapped to the Cartesian coordinates

$(0, 0, -5)$. Similarly, the point $(0, 0, 0)$ in the Cartesian coordinate system goes to $(0, \theta, \varphi)$ in the spherical system, with θ and φ arbitrary. A coordinate whose value is not determined at a singular point is called an **ignorable coordinate** at that point. Thus, at the origin both θ and φ are ignorable. ignorable coordinates

Among the ξ coordinates, let $\{\xi_i\}_{i=k+1}^m$ be ignorable at P with Cartesian coordinates \mathbf{a} . This means that any function, when expressed in terms of ξ 's, will be independent of the ignorable coordinates. A reexamination of Eq. (21.10) reveals that (see Problem 21.8)

$$\delta(\mathbf{x} - \mathbf{a}) = \frac{1}{|J_k|} \prod_{i=1}^k \delta(\xi_i - \alpha_i), \quad \text{where} \quad J_k = \int J d\xi_{k+1} \cdots d\xi_m. \quad (21.11)$$

In particular, if the transformation is invertible, $k = m$ and $J_m = J$, and we recover $J\delta(\mathbf{x} - \mathbf{a}) = \delta(\boldsymbol{\xi} - \boldsymbol{\alpha})$.

Example 21.2.1 In two dimensions the transformation between Cartesian and polar coordinates is given by $x_1 \equiv x = r \cos \theta \equiv \xi_1 \cos \xi_2$, $x_2 \equiv y = r \sin \theta \equiv \xi_1 \sin \xi_2$ with the Jacobian

$$J = \det \begin{pmatrix} \partial x_1 / \partial \xi_1 & \partial x_1 / \partial \xi_2 \\ \partial x_2 / \partial \xi_1 & \partial x_2 / \partial \xi_2 \end{pmatrix} = \det \begin{pmatrix} \cos \xi_2 & -\xi_1 \sin \xi_2 \\ \sin \xi_2 & \xi_1 \cos \xi_2 \end{pmatrix} = \xi_1 = r,$$

which vanishes at the origin. The angle θ is the only ignorable coordinate at the origin. Thus, $k = 2 - 1 = 1$, and

$$J_1 = \int_0^{2\pi} J d\theta = \int_0^{2\pi} r d\theta = 2\pi r \Rightarrow \delta(\mathbf{x}) \equiv \delta(x)\delta(y) = \frac{\delta(r)}{2\pi r}.$$

In three dimensions, the transformation between Cartesian and spherical coordinates yields the Jacobian $J = r^2 \sin \theta$. This vanishes at the origin regardless of the values of θ and φ . We thus have two ignorable coordinates at the origin (therefore, $k = 3 - 2 = 1$), over which we integrate to obtain

$$J_1 = \int_0^{2\pi} d\varphi \int_0^\pi d\theta r^2 \sin \theta = 4\pi r^2 \Rightarrow \delta(\mathbf{x}) = \frac{\delta(r)}{4\pi r^2}.$$

21.2.1 Spherical Coordinates in m Dimensions

In discussing Green's functions in m dimensions, a particular curvilinear coordinate system will prove useful. This system is the generalization of spherical coordinates in three dimensions. The m -dimensional spherical coordinate system is defined as

$$x_k = r \left(\prod_{j=1}^{m-k} \sin \theta_j \right) \cos \theta_{m-k+1}, \quad k = 1, \dots, m, \quad (21.12)$$

where, by definition, we set $\theta_m = 0$ and $\prod_{j=1}^0 \sin \theta_j = 1$. (Note that for $m = 3$, the first two Cartesian coordinates are switched compared to their usual definitions.)

It is not hard to show (see Example 21.2.2) that the Jacobian of the transformation (21.12) is

$$J = r^{m-1} (\sin \theta_1)^{m-2} (\sin \theta_2)^{m-3} \cdots (\sin \theta_k)^{m-k-1} \cdots \sin \theta_{m-2} \quad (21.13)$$

and that the volume element in terms of these coordinates is

$$d^m x = J dr d\theta_1 \cdots d\theta_{m-1} = r^{m-1} dr d\Omega_m, \quad (21.14)$$

where
 element of the
 m -dimensional solid
 angle

$$d\Omega_m = (\sin \theta_1)^{m-2} (\sin \theta_2)^{m-3} \cdots \sin \theta_{m-2} d\theta_1 d\theta_2 \cdots d\theta_{m-1} \quad (21.15)$$

is the element of the m -dimensional solid angle.

Example 21.2.2 For $m = 4$ we have

$$\begin{aligned} x_1 &= r \sin \theta_1 \sin \theta_2 \sin \theta_3, & x_2 &= r \sin \theta_1 \sin \theta_2 \cos \theta_3, \\ x_3 &= r \sin \theta_1 \cos \theta_2, & x_4 &= r \cos \theta_1, \end{aligned}$$

and the Jacobian is given by

$$J = \det \begin{pmatrix} \partial x_1 / \partial r & \partial x_1 / \partial \theta_1 & \partial x_1 / \partial \theta_2 & \partial x_1 / \partial \theta_3 \\ \partial x_2 / \partial r & \partial x_2 / \partial \theta_1 & \partial x_2 / \partial \theta_2 & \partial x_2 / \partial \theta_3 \\ \partial x_3 / \partial r & \partial x_3 / \partial \theta_1 & \partial x_3 / \partial \theta_2 & \partial x_3 / \partial \theta_3 \\ \partial x_4 / \partial r & \partial x_4 / \partial \theta_1 & \partial x_4 / \partial \theta_2 & \partial x_4 / \partial \theta_3 \end{pmatrix} = r^3 \sin^2 \theta_1 \sin \theta_2.$$

It is readily seen (one can use mathematical induction to prove it rigorously) that the Jacobians for $m = 2$ ($J = r$), $m = 3$ ($J = r^2 \sin \theta_1$), and $m = 4$ ($J = r^3 \sin^2 \theta_1 \sin \theta_2$) generalize to Eq. (21.13).

Using the integral

$$\int_0^\pi \sin^n \theta d\theta = \sqrt{\pi} \frac{\Gamma[(n+1)/2]}{\Gamma[(n+2)/2]},$$

the total solid angle in m dimensions can be found to be

$$\Omega_m = \frac{2\pi^{m/2}}{\Gamma(m/2)}. \quad (21.16)$$

An interesting result that is readily obtained is an expression of the delta function in terms of spherical coordinates at the origin. Since $r = 0$, Eq. (21.12) shows that all the angles are ignorable. Thus, we have

$$J_1 = \int J d\theta_1 \cdots d\theta_{m-1} = r^{m-1} \int d\Omega_m = r^{m-1} \Omega_m,$$

which yields

$$\delta(\mathbf{x}) = \delta(x_1) \cdots \delta(x_m) = \frac{\delta(r)}{\Omega_m r^{m-1}} = \frac{\Gamma(m/2) \delta(r)}{2\pi^{m/2} r^{m-1}}. \quad (21.17)$$

21.2.2 Green’s Function for the Laplacian

With the machinery developed above, we can easily obtain the (indefinite) Green’s function for the Laplacian in m dimensions. We will ignore questions of BCs and simply develop a function that satisfies $\nabla^2 G(\mathbf{x}, \mathbf{y}) = \delta(\mathbf{x} - \mathbf{y})$. Without loss of generality we let $\mathbf{y} = 0$; that is, we translate the axes so that \mathbf{y} becomes the new origin. Then we have $\nabla^2 G(\mathbf{x}) = \delta(\mathbf{x})$. In spherical coordinates this becomes

$$\nabla^2 G(\mathbf{x}) = \frac{\delta(r)}{\Omega_m r^{m-1}} \tag{21.18}$$

by (21.17). Since the RHS is a function of r only, we expect G to behave in the same way. We now have to express ∇^2 in terms of spherical coordinates. In general, this is difficult; however, for a function of $r = \sqrt{x_1^2 + \dots + x_m^2}$ alone, such as $F(r)$, we have

$$\frac{\partial F}{\partial x_i} = \frac{\partial F}{\partial r} \frac{\partial r}{\partial x_i} = \frac{\partial F}{\partial r} \frac{x_i}{r} \quad \text{and} \quad \frac{\partial^2 F}{\partial x_i^2} = \frac{\partial^2 F}{\partial r^2} \frac{x_i^2}{r^2} + \frac{\partial F}{\partial r} \left(\frac{1}{r} - \frac{x_i^2}{r^3} \right),$$

so that

$$\nabla^2 F(r) = \sum_{i=1}^m \frac{\partial^2 F}{\partial x_i^2} = \frac{\partial^2 F}{\partial r^2} + \frac{m-1}{r} \frac{\partial F}{\partial r} = \frac{1}{r^{m-1}} \frac{\partial}{\partial r} \left(r^{m-1} \frac{\partial F}{\partial r} \right).$$

For the Green’s function, therefore, we get

$$\frac{d}{dr} \left(r^{m-1} \frac{dG}{dr} \right) = \frac{\delta(r)}{\Omega_m}. \tag{21.19}$$

The solution, for $m \geq 3$, is (see Problem 21.9)

$$G(r) = -\frac{\Gamma(m/2)}{2(m-2)\pi^{m/2}} \left(\frac{1}{r^{m-2}} \right) \quad \text{for } m \geq 3. \tag{21.20}$$

We can restore the vector \mathbf{y} , at which we placed the origin, by noting that $r = |\mathbf{r}| = |\mathbf{x} - \mathbf{y}|$. Thus, we get

$$\begin{aligned} G(\mathbf{x}, \mathbf{y}) &= -\frac{\Gamma(m/2)}{2(m-2)\pi^{m/2}} \left(\frac{1}{|\mathbf{x} - \mathbf{y}|^{m-2}} \right) \\ &= -\frac{\Gamma(m/2)}{2(m-2)\pi^{m/2}} \left[\sum_{i=1}^m (x_i - y_i)^2 \right]^{-(m-2)/2} \quad \text{for } m \geq 3. \end{aligned} \tag{21.21}$$

Green’s function for the Laplacian

Similarly, we obtain

$$G(\mathbf{x}, \mathbf{y}) = \frac{1}{2\pi} \ln |\mathbf{x} - \mathbf{y}| = \frac{1}{4\pi} \ln [(x_1 - y_1)^2 + (x_2 - y_2)^2] \quad \text{for } m = 2. \tag{21.22}$$

solution of Poisson equation in m dimensions

Having found the Green's function for the Laplacian, we can find a solution to the inhomogeneous equation, the *Poisson equation*, $\nabla^2 u = -\rho(\mathbf{x})$. Thus, for $m \geq 3$, we get

$$u(\mathbf{x}) = - \int d^m y G(\mathbf{x}, \mathbf{y}) \rho(\mathbf{y}) = \frac{\Gamma(m/2)}{2(m-2)\pi^{m/2}} \int d^m y \frac{\rho(\mathbf{y})}{|\mathbf{x} - \mathbf{y}|^{m-2}}.$$

In particular, for $m = 3$, we obtain

$$u(\mathbf{x}) = \frac{1}{4\pi} \int d^3 y \frac{\rho(\mathbf{y})}{|\mathbf{x} - \mathbf{y}|},$$

which is the electrostatic potential due to a charge density $\rho(\mathbf{y})$.

21.3 Formal Development

The preceding section was devoted to a discussion of the Green's function for the Laplacian with no mention of the BCs. This section will develop a formalism that not only works for more general operators, but also incorporates the BCs.

21.3.1 General Properties

Basic to a study of GFs is Green's identity, whose 1-dimensional version we encountered in Chap. 20. Here, we generalize it to m dimensions. Suppose there exist two differential operators, \mathbf{L}_x and \mathbf{L}_x^\dagger , which for any two functions u and v , satisfy the following relation:³

$$v^* \mathbf{L}_x[u] - u(\mathbf{L}_x^\dagger[v])^* = \nabla \cdot \mathbf{Q}[u, v^*] \equiv \sum_{i=1}^m \frac{\partial Q_i}{\partial x_i} [u, v^*]. \quad (21.23)$$

The differential operator \mathbf{L}_x^\dagger is—as in the one-dimensional case—called the formal adjoint of \mathbf{L}_x . Integrating (21.23) over a closed domain D in \mathbb{R}^m with boundary ∂D , and using the divergence theorem, we obtain

$$\int_D d^m x \{v^* \mathbf{L}_x[u] - u(\mathbf{L}_x^\dagger[v])^*\} = \int_{\partial D} \mathbf{Q} \cdot \hat{\mathbf{e}}_n da, \quad (21.24)$$

where $\hat{\mathbf{e}}_n$ is an m -dimensional unit vector normal to ∂D , and da is an element of “area” of the m -dimensional hypersurface ∂D . Equation (21.24) is the **generalized Green's identity** for m dimensions. Note that the weight function is set equal to one for simplicity.

³The notions of divergence and divergence theorem require the machinery of differential geometry to which we shall come back later. Here, we are simply using a direct and most obvious generalization of the notions from three to m dimensions.

The differential operator \mathbf{L}_x is said to be formally self-adjoint if the RHS of Eq. (21.24), the surface term, vanishes. In such a case, we have $\mathbf{L}_x = \mathbf{L}_x^\dagger$ as in one dimension. This relation is a necessary condition for the surface term to vanish because u and v are, by assumption, arbitrary. \mathbf{L}_x is called self-adjoint (or, somewhat imprecisely, hermitian) if $\mathbf{L}_x = \mathbf{L}_x^\dagger$ and the domains of the two operators, as determined by the vanishing of the surface term, are identical.

We can use Eq. (21.24) to study the pair of PDEs

$$\mathbf{L}_x[u] = f(\mathbf{x}) \quad \text{and} \quad \mathbf{L}_x^\dagger[v] = h(\mathbf{x}). \quad (21.25)$$

As in one dimension, we let $G(\mathbf{x}, \mathbf{y})$ and $g(\mathbf{x}, \mathbf{y})$ denote the Green's functions for \mathbf{L}_x and \mathbf{L}_x^\dagger , respectively. Let us assume that the BCs are such that the surface term in Eq. (21.24) vanishes. Then we get Green's identity

$$\int_D d^m x v^* \mathbf{L}_x[u] = \int_D d^m x u (\mathbf{L}_x^\dagger[v])^*. \quad (21.26)$$

If in this equation we let $u = G(\mathbf{x}, \mathbf{t})$ and $v = g(\mathbf{x}, \mathbf{y})$, where $\mathbf{t}, \mathbf{y} \in D$, we obtain

$$\int_D d^m x g^*(\mathbf{x}, \mathbf{y}) \delta(\mathbf{x} - \mathbf{t}) = \int_D d^m x G(\mathbf{x}, \mathbf{t}) \delta(\mathbf{x} - \mathbf{y}),$$

or $g^*(\mathbf{t}, \mathbf{y}) = G(\mathbf{y}, \mathbf{t})$. In particular, when \mathbf{L}_x is formally self-adjoint, we have $G^*(\mathbf{t}, \mathbf{y}) = G(\mathbf{y}, \mathbf{t})$, or $G(\mathbf{t}, \mathbf{y}) = G(\mathbf{y}, \mathbf{t})$, if all the coefficient functions of \mathbf{L}_x are real. That is, the Green's function will be symmetric.

If we let $v = g(\mathbf{x}, \mathbf{y})$ and use the first equation of (21.25) in (21.26), we get $u(\mathbf{y}) = \int_D d^m x g^*(\mathbf{x}, \mathbf{y}) f(\mathbf{x})$, which, using $g^*(\mathbf{t}, \mathbf{y}) = G(\mathbf{y}, \mathbf{t})$ and interchanging \mathbf{x} and \mathbf{y} , becomes $u(\mathbf{x}) = \int_D d^m y G(\mathbf{x}, \mathbf{y}) f(\mathbf{y})$. It can similarly be shown that $v(\mathbf{x}) = \int_D d^m y g(\mathbf{x}, \mathbf{y}) h(\mathbf{y})$.

Green's functions are symmetric functions of their arguments

21.3.2 Fundamental (Singular) Solutions

The inhomogeneous term of the differential equation to which $G(\mathbf{x}, \mathbf{y})$ is a solution is the delta function, $\delta(\mathbf{x} - \mathbf{y})$. It would be surprising if $G(\mathbf{x}, \mathbf{y})$ did not “take notice” of this catastrophic source term and did not adapt itself to behave differently at $\mathbf{x} = \mathbf{y}$ than at any other “ordinary” point. We noted the singular behavior of the Green's function at $x = y$ in one dimension when we proved Theorem 20.3.5. There we introduced $h(x, y)$ —which was discontinuous at $x = y$ —as a part of the Green's function. Similarly, when we discussed the Green's functions for the Laplacian in two and m dimensions earlier in this chapter, we noted that they behaved singularly at $\mathbf{r} = 0$ or $\mathbf{x} = \mathbf{y}$. In this section, we study similar properties of the GFs for other differential operators.

Next to the Laplacian in difficulty is the formally self-adjoint elliptic PDO $\mathbf{L}_x = \nabla^2 + q(\mathbf{x})$ discussed in Problem 21.10. Substituting this operator in the generalized Green's identity and using the expression for \mathbf{Q} given in

Problem 21.10, we obtain

$$\int_D d^m x \{v \mathbf{L}_x[u] - u(\mathbf{L}_x[v])\} = \int_{\partial D} (v \hat{\mathbf{e}}_n \cdot \nabla u - u \hat{\mathbf{e}}_n \cdot \nabla v) da.$$

Letting $v = G(\mathbf{x}, \mathbf{y})$ and denoting $\hat{\mathbf{e}}_n \cdot \nabla$ by $\partial/\partial n$ gives

$$\int_D d^m x [G \mathbf{L}_x u - u \mathbf{L}_x G] = \int_{\partial D} \left[G \frac{\partial u}{\partial n} - u \frac{\partial G}{\partial n} \right] da. \quad (21.27)$$

We want to use this equation to find out about the behavior of $G(\mathbf{x}, \mathbf{y})$ as $|\mathbf{x} - \mathbf{y}| \rightarrow 0$. Therefore, assuming that $\mathbf{y} \in D$, we divide the domain D into two parts: one part is a region D_ϵ bounded by an infinitesimal hypersphere S_ϵ with radius ϵ and center at \mathbf{y} ; the other is the rest of D . Instead of D we use the region $D' \equiv D - D_\epsilon$. The following facts are easily deduced for D' :

- (1) $\mathbf{L}_x G(\mathbf{x}, \mathbf{y}) = 0$ because $\mathbf{x} \neq \mathbf{y}$ in D' ;
- (2) $\int_D = \lim_{\epsilon \rightarrow 0} \int_{D'}$;
- (3) $\partial D' = \partial D \cup S_\epsilon$.

Suppose that we are interested in finding a solution to

$$\mathbf{L}_x[u] = [\nabla^2 + q(\mathbf{x})]u(\mathbf{x}) = f(\mathbf{x})$$

subject to certain, as yet unspecified, BCs. Using the three facts listed above, Eq. (21.27) yields

$$\begin{aligned} & \int_D d^m x [G \mathbf{L}_x u - u \mathbf{L}_x G] \\ &= \lim_{\epsilon \rightarrow 0} \int_{D'} d^m x \left[\underbrace{G \mathbf{L}_x u}_{=f} - u \underbrace{\mathbf{L}_x G}_{=0} \right] \\ &= \lim_{\epsilon \rightarrow 0} \int_{D'} d^m x G(\mathbf{x}, \mathbf{y}) f(\mathbf{x}) = \int_D d^m x G(\mathbf{x}, \mathbf{y}) f(\mathbf{x}) \\ &= \int_{\partial D} \left(G \frac{\partial u}{\partial n} - u \frac{\partial G}{\partial n} \right) da + \int_{S_\epsilon} \left(G \frac{\partial u}{\partial n} - u \frac{\partial G}{\partial n} \right) da. \end{aligned}$$

We assume that the BCs are such that the integral over ∂D vanishes. This is a generalization of the one-dimensional case (recall from Chap. 20 that this is a necessary condition for the existence of Green's functions). Moreover, for an m -dimensional sphere, $da = r^{m-1} d\Omega_m$, which for S_ϵ reduces to $\epsilon^{m-1} d\Omega_m$. Substituting in the preceding equation yields

$$\int_D d^m x G(\mathbf{x}, \mathbf{y}) f(\mathbf{x}) = \int_{S_\epsilon} \left(G \frac{\partial u}{\partial n} - u \frac{\partial G}{\partial n} \right) \epsilon^{m-1} d\Omega_m.$$

We would like the RHS to be $u(\mathbf{y})$. This will be the case if

$$\lim_{\epsilon \rightarrow 0} \int_{S_\epsilon} G(\mathbf{x}, \mathbf{y}) \frac{\partial u}{\partial n} \epsilon^{m-1} d\Omega_m = 0 \quad \text{and} \quad \lim_{\epsilon \rightarrow 0} \int_{S_\epsilon} u \frac{\partial G}{\partial n} \epsilon^{m-1} d\Omega_m = u(\mathbf{y})$$

for arbitrary u . This will happen only if

$$\lim_{r \rightarrow 0} G(\mathbf{y} + \mathbf{r}, \mathbf{y})r^{m-1} = 0, \quad \lim_{r \rightarrow 0} \frac{\partial G}{\partial r}(\mathbf{y} + \mathbf{r}, \mathbf{y})r^{m-1} = \text{const.} \quad (21.28)$$

A solution to these two equations is

$$G(\mathbf{x}, \mathbf{y}) = \begin{cases} -\frac{F(\mathbf{x}, \mathbf{y})}{2\pi} \ln(|\mathbf{x} - \mathbf{y}|) + H(\mathbf{x}, \mathbf{y}) & \text{if } m = 2, \\ -\frac{1}{(m-2)\Omega_m} \frac{F(\mathbf{x}, \mathbf{y})}{|\mathbf{x} - \mathbf{y}|^{m-2}} + H(\mathbf{x}, \mathbf{y}) & \text{if } m \geq 3, \end{cases} \quad (21.29)$$

where $H(\mathbf{x}, \mathbf{y})$ and $F(\mathbf{x}, \mathbf{y})$ are well behaved at $\mathbf{x} = \mathbf{y}$. The introduction of these functions is necessary because Eq. (21.28) determines the behavior of $G(\mathbf{x}, \mathbf{y})$ only when $\mathbf{x} \approx \mathbf{y}$. Such behavior does not uniquely determine $G(\mathbf{x}, \mathbf{y})$. For instance, $e^{|\mathbf{x}-\mathbf{y}|} \ln(|\mathbf{x} - \mathbf{y}|)$ and $\ln(|\mathbf{x} - \mathbf{y}|)$ behave in the same way as $|\mathbf{x} - \mathbf{y}| \rightarrow 0$.

Equation (21.29) shows that for $\mathbf{L}_x = \nabla^2 + q(\mathbf{x})$, the Green's function consists of two parts. The first part determines the singular behavior of the Green's function as $\mathbf{x} \rightarrow \mathbf{y}$. The nature of this singularity (how badly the GF "blows up" as $\mathbf{x} \rightarrow \mathbf{y}$) is extremely important, because it is a prerequisite for our ability to write the solution in terms of an integral representation with the Green's function as its kernel. Due to their importance in such representations, the first terms on the RHS of Eq. (21.29) are called the **fundamental solution** of the differential equation, or the **singular part** of the Green's function.

fundamental solution is the singular part of GF

What about the second part of the Green's function? What role does it play in obtaining a solution? So far we have been avoiding consideration of BCs. Here $H(\mathbf{x}, \mathbf{y})$ can help. We choose $H(\mathbf{x}, \mathbf{y})$ in such a way that $G(\mathbf{x}, \mathbf{y})$ satisfies the appropriate BCs. Let us discuss this in greater detail and generality.

If BCs are ignored, the Green's function for a SOPDO \mathbf{L}_x cannot be determined uniquely. In particular, if $G(\mathbf{x}, \mathbf{y})$ is a Green's function, that is, if $\mathbf{L}_x G(\mathbf{x}, \mathbf{y}) = \delta(\mathbf{x} - \mathbf{y})$, then so is $G(\mathbf{x}, \mathbf{y}) + H(\mathbf{x}, \mathbf{y})$ as long as $H(\mathbf{x}, \mathbf{y})$ is a solution of the homogeneous equation $\mathbf{L}_x H(\mathbf{x}, \mathbf{y}) = 0$. Thus, we can break the Green's function into two parts:

homogeneous solution is the regular part of GF

$$G = G_s + H, \quad \text{where } \mathbf{L}_x G_s(\mathbf{x}, \mathbf{y}) = \delta(\mathbf{x} - \mathbf{y}), \quad \mathbf{L}_x H(\mathbf{x}, \mathbf{y}) = 0 \quad (21.30)$$

with G_s the singular part of the Green's function. H is called the **regular part** of the Green's function. Neither G_s nor H (nor G , therefore) is unique. However, the appropriate BCs, which depend on the type of \mathbf{L}_x , will determine G uniquely.

regular part of the Green's function

To be more specific, let us assume that we want to find a Green's function for \mathbf{L}_x that vanishes at the boundary ∂D . That is, we wish to find $G(\mathbf{x}, \mathbf{y})$ such that $G(\mathbf{x}_b, \mathbf{y}) = 0$, where \mathbf{x}_b is an arbitrary point of the boundary. All that is required is to find a G_s and an H satisfying Eq. (21.30) with the BC $H(\mathbf{x}_b, \mathbf{y}) = -G_s(\mathbf{x}_b, \mathbf{y})$. The latter problem, involving a homogeneous differential equation, can be handled by the methods of Chap. 19. Since any discussion of BCs is tied to the type of PDE, we have reserved the discussion of such specifics for the next chapter.

21.4 Integral Equations and GFs

Integral equations are best applied in combination with Green's functions. In fact, we can use a Green's function to turn a DE into an integral equation. If this integral equation is compact or has a compact resolvent, then the problem lends itself to the methods described in Chaps. 17 and 18.

Let \mathbf{L}_x be a SOPDO in m variables. We are interested in solving the SOPDE

$$\mathbf{L}_x[u] + \lambda V(\mathbf{x})u(\mathbf{x}) = f(\mathbf{x})$$

subject to some BCs. Here λ is an arbitrary constant, and $V(\mathbf{x})$ is a well-behaved function on \mathbb{R}^m . Transferring the second term on the LHS to the RHS and then treating the RHS as an inhomogeneous term, we can write the "solution" to the PDE as

$$u(\mathbf{x}) = H(\mathbf{x}) + \int_D d^m y G_0(\mathbf{x}, \mathbf{y}) [f(\mathbf{y}) - \lambda V(\mathbf{y})u(\mathbf{y})],$$

where D is the domain of \mathbf{L}_x and G_0 is the Green's function for \mathbf{L}_x with some, as yet unspecified, BCs. The function H is a solution to the homogeneous equation, and it is present to guarantee the appropriate BCs.

Combining the first term in the integral with $H(\mathbf{x})$, we have

$$u(\mathbf{x}) = F(\mathbf{x}) - \lambda \int_D d^m y G_0(\mathbf{x}, \mathbf{y}) V(\mathbf{y})u(\mathbf{y}). \quad (21.31)$$

Equation (21.31) is an m -dimensional Fredholm equation whose solution can be obtained in the form of a Neumann series.

Example 21.4.1 Consider the bound-state Schrödinger equation in one dimension:

$$-\frac{\hbar^2}{2\mu} \frac{d^2 \Psi}{dx^2} + V(x)\Psi(x) = E\Psi(x), \quad E < 0.$$

We rewrite this equation as

$$\mathbf{L}_x[\Psi] \equiv \left(\frac{d^2}{dx^2} - \kappa^2 \right) \Psi(x) = \frac{2\mu}{\hbar^2} V(x)\Psi(x),$$

where $\kappa^2 = -2\mu E/\hbar^2 > 0$. Equation (21.31) gives the equivalent integral equation

$$\Psi(x) = \Psi_0(x) + \frac{2\mu}{\hbar^2} \int_{-\infty}^{\infty} G_0(x, y) V(y)\Psi(y) dy$$

where $\Psi_0(x)$ is the solution of $\mathbf{L}_x[\Psi_0] = 0$, which is easily found to be of the general form $\Psi_0(x) = Ae^{\kappa x} + Be^{-\kappa x}$. If we assume that $\Psi_0(x)$ remains finite as $x \rightarrow \pm\infty$, $\Psi_0(x)$ will be zero. Furthermore, it can be shown that $G_0(x, y) = -e^{-\kappa|x-y|}/2\kappa$ (see Problem 20.12). Therefore,

$$\Psi(x) = -\frac{\mu}{\hbar^2 \kappa} \int_{-\infty}^{\infty} e^{-\kappa|x-y|} V(y)\Psi(y) dy.$$

Now consider an attractive delta-function potential with center at a :

$$V(x) = -V_0\delta(x - a), \quad V_0 > 0.$$

For such a potential, the integral equation yields

$$\Psi(x) = \frac{\mu}{\hbar^2\kappa} \int_{-\infty}^{\infty} e^{-\kappa|x-y|} V_0\delta(y - a)\Psi(y) dy = \frac{\mu V_0}{\hbar^2\kappa} e^{-\kappa|x-a|}\Psi(a).$$

For this equation to be consistent, i.e., to get an identity when $x = a$, we must have

$$\frac{\mu V_0}{\hbar^2\kappa} = 1 \Rightarrow \kappa = \frac{\mu V_0}{\hbar^2} \Rightarrow E = -\frac{\mu V_0}{2\hbar^2}.$$

There is only one nondegenerate quantum state for an attractive delta function potential.

Therefore, there is only one bound state and one energy level for an attractive delta-function potential.

To find a Neumann-series solution we can substitute the expression for u given by the RHS of Eq. (21.31) in the integral of that equation. The resulting equation will have two integrals, in the second of which u appears. Substituting the new u in the second integral and continuing the process N times yields

$$u(\mathbf{x}) = F(\mathbf{x}) + \sum_{n=1}^{N-1} (-\lambda)^n \int_D d^m y K^n(\mathbf{x}, \mathbf{y}) F(\mathbf{y}) + (-\lambda)^N \int_D d^m y K^N(\mathbf{x}, \mathbf{y}) u(\mathbf{y}),$$

where

$$K(\mathbf{x}, \mathbf{y}) \equiv V(\mathbf{x})G_0(\mathbf{x}, \mathbf{y}),$$

$$K^n(\mathbf{x}, \mathbf{y}) \equiv \int_D d^m t K^{n-1}(\mathbf{x}, \mathbf{t})K(\mathbf{t}, \mathbf{y}) \quad \text{for } n \geq 2. \tag{21.32}$$

The Neumann series is obtained by letting $N \rightarrow \infty$:

$$u(\mathbf{x}) = F(\mathbf{x}) + \sum_{n=1}^{\infty} (-\lambda)^n \int_D d^m y K^n(\mathbf{x}, \mathbf{y}) F(\mathbf{y}). \tag{21.33}$$

Except for the fact that here the integrations are in m variables, Eq. (21.33) is the same as the Neumann series derived in Sect. 18.1. In exact analogy, therefore, we abbreviate (21.33) as

$$|u\rangle = |F\rangle + \sum_{n=1}^{\infty} (-\lambda)^n \mathbf{K}^n |F\rangle. \tag{21.34}$$

Equations (21.33) and (21.34) have meaning only if the Neumann series converges, i.e., if

$$|\lambda| \left[\int_D d^m y \int_D d^m x |K(\mathbf{x}, \mathbf{y})|^2 \right]^{1/2} < 1. \tag{21.35}$$

We will briefly discuss an intuitive physical interpretation of the Neumann series due to Feynman. Although Feynman developed this *diagrammatic technique* for quantum electrodynamics, it has been useful in other areas, such as statistical and condensed matter physics. In most cases of interest, the SOPDE is homogeneous, so $f(\mathbf{x}) = 0$. In that case, \mathbf{L}_x and $V(\mathbf{x})$ are called the *free operator* and the *interacting potential*, respectively. The solution to $\mathbf{L}_x[u] = 0$ is called the *free solution* and denoted by $u_f(\mathbf{x})$.

Feynman's diagrammatic representation of GF

Let us start with Eq. (21.31) written as

$$u(\mathbf{x}) = u_f(\mathbf{x}) - \lambda \int_{\mathbb{R}^m} d^m y G_0(\mathbf{x}, \mathbf{y}) V(\mathbf{y}) u(\mathbf{y}), \quad (21.36)$$

where G_0 stands for the Green's function for the free operator \mathbf{L}_x . The full Green's function, that is, that for $\mathbf{L}_x + \lambda V$, will be denoted by G . Moreover, as is usually the case, the region D has been taken to be all of \mathbb{R}^m . This implies that no boundary conditions are imposed on u , which in turn permits us to use the singular part of the Green's function in the integral. Because of the importance of the full Green's function, we are interested in finding a series for G in terms of G_0 , which is supposed to be known. To obtain such a series we start with the abstract operator equation and write $\mathbf{G} = \mathbf{G}_0 + \mathbf{A}$, where \mathbf{A} is to be determined. Operating on both sides with \mathbf{L} ("inverse" of \mathbf{G}_0), we obtain $\mathbf{L}\mathbf{G} = \mathbf{L}\mathbf{G}_0 + \mathbf{L}\mathbf{A} = \mathbf{1} + \mathbf{L}\mathbf{A}$. On the other hand, $(\mathbf{L} + \lambda\mathbf{V})\mathbf{G} = \mathbf{1}$, or $\mathbf{L}\mathbf{G} = \mathbf{1} - \lambda\mathbf{V}\mathbf{G}$. These two equations give

$$\mathbf{L}\mathbf{A} = -\lambda\mathbf{V}\mathbf{G} \Rightarrow \mathbf{A} = -\lambda\mathbf{L}^{-1}\mathbf{V}\mathbf{G} = -\lambda\mathbf{G}_0\mathbf{V}\mathbf{G}.$$

Therefore,

$$\mathbf{G} = \mathbf{G}_0 - \lambda\mathbf{G}_0\mathbf{V}\mathbf{G}. \quad (21.37)$$

Sandwiching both sides between $\langle \mathbf{x} |$ and $| \mathbf{z} \rangle$, inserting $\mathbf{1} = \int | \mathbf{y} \rangle \langle \mathbf{y} | d^m y$ between \mathbf{G}_0 and \mathbf{V} and $\mathbf{1} = \int | \mathbf{t} \rangle \langle \mathbf{t} | d^m t$ between \mathbf{V} and \mathbf{G} , and assuming that \mathbf{V} is local [i.e., $V(\mathbf{y}, \mathbf{t}) = V(\mathbf{y})\delta(\mathbf{y} - \mathbf{t})$], we obtain

$$G(\mathbf{x}, \mathbf{z}) = G_0(\mathbf{x}, \mathbf{z}) - \lambda \int d^m y G_0(\mathbf{x}, \mathbf{y}) V(\mathbf{y}) G(\mathbf{y}, \mathbf{z}). \quad (21.38)$$

This equation is the analogue of (21.31) and, just like that equation, is amenable to a Neumann series expansion. The result is

$$G(\mathbf{x}, \mathbf{y}) = G_0(\mathbf{x}, \mathbf{y}) + \sum_{n=1}^{\infty} (-\lambda)^n \int_{\mathbb{R}^m} d^m z G_0(\mathbf{x}, \mathbf{z}) K^n(\mathbf{z}, \mathbf{y}), \quad (21.39)$$

where $K^n(\mathbf{x}, \mathbf{z})$ is as given in Eq. (21.32).

GF as propagator

Feynman's idea is to consider $G(\mathbf{x}, \mathbf{y})$ as an interacting **propagator** between points \mathbf{x} and \mathbf{y} and $G_0(\mathbf{x}, \mathbf{y})$ as a free propagator. The first term on the RHS of (21.39) is simply a free propagation from \mathbf{x} to \mathbf{y} . Diagrammatically, it is represented by a line joining the points \mathbf{x} and \mathbf{y} [see Fig. 21.1(a)]. The second term is a free propagation from \mathbf{x} to \mathbf{y}_1 (also called a **vertex**), interaction at \mathbf{y}_1 with a potential $-\lambda V(\mathbf{y}_1)$, and subsequent free propagation to \mathbf{y} [see Fig. 21.1(b)]. According to the third term, the particle or wave

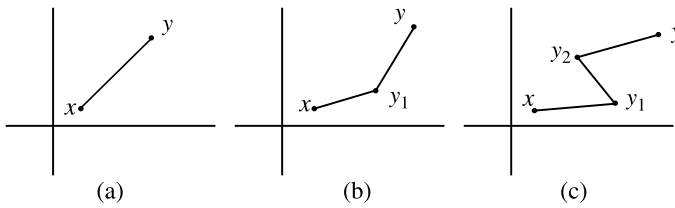

Fig. 21.1 Contributions to the full propagator in (a) the zeroth order, (b) the first order, and (c) the second order. At each vertex one introduces a factor of $-\lambda V$ and integrates over all values of the variable of that vertex

[represented by $u_f(\mathbf{x})$] propagates freely from \mathbf{x} to \mathbf{y}_1 , interacts at \mathbf{y}_1 with the potential $-\lambda V(\mathbf{y}_1)$, propagates freely from \mathbf{y}_1 to \mathbf{y}_2 , interacts for a second time with the potential $-\lambda V(\mathbf{y}_2)$, and finally propagates freely from \mathbf{y}_2 to \mathbf{y} [Fig. 21.1(c)]. The interpretation of the rest of the series in (21.39) is now clear: The n th-order term of the series has n vertices between \mathbf{x} and \mathbf{y} with a factor $-\lambda V(\mathbf{y}_k)$ and an integration over \mathbf{y}_k at vertex k . Between any two consecutive vertices \mathbf{y}_k and \mathbf{y}_{k+1} there is a factor of the free propagator $G_0(\mathbf{y}_k, \mathbf{y}_{k+1})$.

Feynman diagrams are used extensively in relativistic quantum field theory, for which $m = 4$, corresponding to the four-dimensional space-time. In this context λ is determined by the strength of the interaction. For quantum electrodynamics, for instance, λ is the fine-structure constant, $e^2/\hbar c = 1/137$.

21.5 Perturbation Theory

Few operator equations lend themselves to an exact solution, and due to the urgency of finding a solution to such equations in fundamental physics, various techniques have been developed to approximate solutions to operator equations. We have already seen instances of such techniques in, for example, the WKB method. This section is devoted to a systematic development of perturbation theory, which is one of the main tools of calculation in quantum mechanics. For a thorough treatment of perturbation theory along the lines presented here, see [Mess 66, pp. 712–720].

The starting point is the resolvent (Definition 17.7.1) of a Hamiltonian \mathbf{H} , which, using z instead of λ , we write as $\mathbf{R}_z(\mathbf{H})$. For simplicity, we assume that the eigenvalues of \mathbf{H} are discrete. This is a valid assumption if the Hamiltonian is compact or if we are interested in approximations close to one of the discrete eigenvalues. Denoting the eigenvalues of \mathbf{H} by $\{E_i\}_{i=0}^\infty$, we have

$$\mathbf{H}\mathbf{P}_i = E_i\mathbf{P}_i, \tag{21.40}$$

where \mathbf{P}_i is the projection operator to the i th eigenspace. We can write the resolvent in terms of the projection operators by using Eq. (17.6):

$$\mathbf{R}_z(\mathbf{H}) = \sum_{i=0}^\infty \frac{\mathbf{P}_i}{E_i - z}. \tag{21.41}$$

The projection operator \mathbf{P}_i can be written as a contour integral as in Eq. (17.11). Any sum of these operators can also be written as a contour integral. For instance, if Γ is a circle enclosing the first $n + 1$ eigenvalues, then

$$\mathbf{P}_\Gamma \equiv \sum_{i=0}^n \mathbf{P}_i = -\frac{1}{2\pi i} \oint_{\Gamma} \mathbf{R}_z(\mathbf{H}) dz. \quad (21.42)$$

Multiplying Eq. (21.42) by \mathbf{H} and using the definition of the resolvent, one can show that

$$\mathbf{H}\mathbf{P}_\Gamma = -\frac{1}{2\pi i} \oint_{\Gamma} z \mathbf{R}_z(\mathbf{H}) dz. \quad (21.43)$$

When Γ includes *all* eigenvalues of \mathbf{H} , $\mathbf{P}_\Gamma = \mathbf{1}$, and Eq. (21.43) reduces to (17.10) with $\mathbf{A} \rightarrow \mathbf{T}$ and $f(x) \rightarrow x$.

To proceed, let us assume that $\mathbf{H} = \mathbf{H}_0 + \lambda \mathbf{V}$ where \mathbf{H}_0 is a Hamiltonian with known eigenvalues and eigenvectors, and \mathbf{V} is a *perturbing potential*; λ is a (small) parameter that keeps track of the order of approximation. Let us also use the abbreviations

$$\mathbf{G}(z) \equiv -\mathbf{R}_z(\mathbf{H}) \quad \text{and} \quad \mathbf{G}_0(z) \equiv -\mathbf{R}_z(\mathbf{H}_0). \quad (21.44)$$

Then a procedure very similar to that leading to Eq. (21.37) yields

$$\mathbf{G}(z) = \mathbf{G}_0(z) + \lambda \mathbf{G}_0(z) \mathbf{V} \mathbf{G}(z), \quad (21.45)$$

which can be expanded in a Neumann series by iteration:

$$\mathbf{G}(z) = \sum_{n=0}^{\infty} \lambda^n \mathbf{G}_0(z) [\mathbf{V} \mathbf{G}_0(z)]^n. \quad (21.46)$$

Let $\{E_a^0\}$, $\{\mathcal{M}_a^0\}$, and m_a denote, respectively, the eigenvalues of \mathbf{H}_0 , their corresponding eigenspaces, and the latter's dimensions.⁴ In the context of perturbation theory, m_a is called the **degeneracy** of E_a^0 , and E_a^0 is called **m_a -fold degenerate**, with a similar terminology for the perturbed Hamiltonian. We assume that all eigenspaces have finite dimensions.

It is clear that eigenvalues and eigenspaces of \mathbf{H} will tend to those of \mathbf{H}_0 when $\lambda \rightarrow 0$. So, let us collect all eigenspaces of \mathbf{H} that tend to \mathcal{M}_a^0 and denote them by $\{\mathcal{M}_i^a\}_{i=1}^{r_a}$. Similarly, we use E_i^a and \mathbf{P}_i^a to denote, respectively, the energy eigenvalue and the projector to the eigenspace \mathcal{M}_i^a . Since dimension is a discrete quantity, it cannot depend on λ , and we have

$$\sum_{i=1}^{r_a} \dim \mathcal{M}_i^a = \dim \mathcal{M}_a^0 = m_a. \quad (21.47)$$

⁴We use the beginning letters of the Latin alphabet for the unperturbed Hamiltonian. Furthermore, we attach a superscript "0" to emphasize that the object belongs to \mathbf{H}_0 .

We also use the notation \mathbf{P} for the projector onto the direct sum of \mathcal{M}_i^a 's. We thus have

$$\mathbf{P} \equiv \sum_{i=1}^{r_a} \mathbf{P}_i^a \quad \text{and} \quad \lim_{\lambda \rightarrow 0} \mathbf{P} = \mathbf{P}_a^0, \quad (21.48)$$

where we have used an obvious notation for the projection operator onto \mathcal{M}_a^0 .

The main task of perturbation theory is to find the eigenvalues and eigenvectors of the perturbed Hamiltonian in terms of a series in powers of λ of the corresponding unperturbed quantities. Since the eigenvectors—or, more appropriately, the projectors onto eigenspaces—and their corresponding eigenvalues of the perturbed Hamiltonian are related via Eq. (21.40), this task reduces to writing \mathbf{P} as a series in powers of λ whose coefficients are operators expressible in terms of unperturbed quantities.

For sufficiently small λ , there exists a contour in the z -plane enclosing E_a^0 and all E_i^a 's but excluding all other eigenvalues of \mathbf{H} and \mathbf{H}_0 . Denote this contour by Γ_a and, using Eq. (21.42), write

$$\mathbf{P} = \frac{1}{2\pi i} \oint_{\Gamma_a} \mathbf{G}(z) dz.$$

It follows from Eq. (21.46) that

$$\begin{aligned} \mathbf{P} &= \mathbf{P}_a^0 + \sum_{n=1}^{\infty} \lambda^n \mathbf{A}^{(n)}, \quad \text{where} \\ \mathbf{A}^{(n)} &\equiv \frac{1}{2\pi i} \oint_{\Gamma_a} \mathbf{G}_0(z) [\mathbf{V}\mathbf{G}_0(z)]^n dz. \end{aligned} \quad (21.49)$$

This equation shows that perturbation expansion is reduced to the calculation of $\mathbf{A}^{(n)}$, which is simply the residue of $\mathbf{G}_0(z) [\mathbf{V}\mathbf{G}_0(z)]^n$. The only singularity of the integrand in Eq. (21.49) comes from $\mathbf{G}_0(z)$, which, by (21.44) and (21.41), has a pole at E_a^0 . So, to calculate this residue, we simply expand $\mathbf{G}_0(z)$ in a Laurent series about E_a^0 :

$$\begin{aligned} \mathbf{G}_0(z) &= \sum_b \frac{\mathbf{P}_b^0}{z - E_b^0} \\ &= \frac{\mathbf{P}_a^0}{z - E_a^0} + \sum_{b \neq a} \frac{\mathbf{P}_b^0}{z - E_b^0} \\ &= \frac{\mathbf{P}_a^0}{z - E_a^0} + \sum_{b \neq a} \frac{\mathbf{P}_b^0}{(E_a^0 - E_b^0) \left(1 + \frac{z - E_a^0}{E_a^0 - E_b^0}\right)} \\ &= \frac{\mathbf{P}_a^0}{z - E_a^0} + \sum_{b \neq a} \sum_{k=0}^{\infty} (-1)^k \frac{(z - E_a^0)^k \mathbf{P}_b^0}{(E_a^0 - E_b^0)^{k+1}}. \end{aligned}$$

Switching the order of the two sums, and noting that our space is the Hilbert space of \mathbf{H}_0 whose basis can be chosen to consist of eigenstates of \mathbf{H}_0 , we can write \mathbf{H}_0 instead of E_b^0 in the denominator to obtain

$$\begin{aligned} \sum_{b \neq a} \frac{\mathbf{P}_b^0}{(E_a^0 - E_b^0)^{k+1}} &= \sum_{b \neq a} \frac{\mathbf{P}_b^0}{(E_a^0 - \mathbf{H}_0)^{k+1}} \\ &= \frac{\sum_{b \neq a} \mathbf{P}_b^0}{(E_a^0 - \mathbf{H}_0)^{k+1}} = \frac{\overbrace{\mathbf{1} - \mathbf{P}_a^0}^{\equiv \mathbf{Q}_a^0}}{(E_a^0 - \mathbf{H}_0)^{k+1}} \\ &= \frac{\mathbf{Q}_a^0}{(E_a^0 - \mathbf{H}_0)^{k+1}} \equiv \mathbf{G}_0^{k+1}(E_a^0)\mathbf{Q}_a^0 = \mathbf{Q}_a^0\mathbf{G}_0^{k+1}(E_a^0)\mathbf{Q}_a^0, \end{aligned}$$

where we have used the completeness relation for the \mathbf{P}_b^0 's, the fact that \mathbf{Q}_a^0 commutes with \mathbf{H}_0 [and, therefore, with $\mathbf{G}_0^{k+1}(E_a^0)$], and, in the last equality, the fact that \mathbf{Q}_a^0 is a projection operator.⁵ It follows that

$$\begin{aligned} \mathbf{G}_0(z) &= \frac{\mathbf{P}_a^0}{z - E_a^0} + \sum_{k=0}^{\infty} (-1)^k (z - E_a^0)^k \mathbf{Q}_a^0 \mathbf{G}_0^{k+1}(E_a^0) \mathbf{Q}_a^0 \\ &= \sum_{k=0}^{\infty} (-1)^k (z - E_a^0)^{k-1} \mathbf{S}^k, \end{aligned} \quad (21.50)$$

where we have introduced the notation

$$\mathbf{S}^k \equiv \begin{cases} \mathbf{P}_a^0 & \text{if } k = 0, \\ -\mathbf{Q}_a^0 \mathbf{G}_0^k(E_a^0) \mathbf{Q}_a^0 & \text{if } k \geq 1. \end{cases}$$

By substituting Eq. (21.50) in $\mathbf{G}_0(z)[\mathbf{V}\mathbf{G}_0(z)]^n$ we obtain a Laurent expansion whose coefficient of $(z - E_a^0)^{-1}$ is $\mathbf{A}^{(n)}$. The reader may check that such a procedure yields

$$\mathbf{A}^{(n)} = (-1)^{n+1} \sum_{(n)} \mathbf{S}^{k_1} \mathbf{V} \mathbf{S}^{k_2} \mathbf{V} \dots \mathbf{V} \mathbf{S}^{k_{n+1}}, \quad (21.51)$$

where by definition, $\sum_{(p)}$ extends over all nonnegative integers $\{k_i\}_{i=1}^{n+1}$ such that

$$\sum_{i=1}^{n+1} k_i = p \quad \forall p \geq 0.$$

⁵Note that although $\mathbf{G}_0(z)$ has a pole at E_a^0 , the expressions in the last line of the equation above make sense because \mathbf{Q}_a^0 annihilates all states with eigenvalue E_a^0 . The reason for the introduction of \mathbf{Q}_a^0 on both sides is to ensure that $\mathbf{G}_0^{k+1}(E_a^0)$ will not act on an eigenstate of E_a^0 on either side.

It turns out that for perturbation expansion, not only do we need the expansion of \mathbf{P} [Eqs. (21.49) and (21.51)], but also an expansion for \mathbf{HP} . Using Eqs. (21.43) and (21.44), with Γ replaced by Γ_a , we have

$$\begin{aligned}\mathbf{HP} &= \frac{1}{2\pi i} \oint_{\Gamma_a} z \mathbf{G}(z) dz = \frac{1}{2\pi i} \oint_{\Gamma_a} (z - E_a^0 + E_a^0) \mathbf{G}(z) dz \\ &= \frac{1}{2\pi i} \oint_{\Gamma_a} (z - E_a^0) \mathbf{G}(z) dz + E_a^0 \mathbf{P}.\end{aligned}$$

Substituting for $\mathbf{G}(z)$ from Eq. (21.46), we can rewrite this equation as

$$(\mathbf{H} - E_a^0) \mathbf{P} = \sum_{n=1}^{\infty} \lambda^n \mathbf{B}^{(n)}, \quad (21.52)$$

where

$$\mathbf{B}^{(n)} = (-1)^{n-1} \sum_{(n-1)} \mathbf{S}^{k_1} \mathbf{V} \mathbf{S}^{k_2} \mathbf{V} \dots \mathbf{V} \mathbf{S}^{k_{n+1}}. \quad (21.53)$$

Equations (21.52) and (21.53) can be used to approximate the eigenvectors and eigenvalues of the perturbed Hamiltonian in terms of those of the unperturbed Hamiltonian. It is convenient to consider two cases: the nondegenerate case in which $m_a = 1$, and the degenerate case in which $m_a \geq 2$.

21.5.1 The Nondegenerate Case

In the nondegenerate case, we let $|a^0\rangle$ denote the original unperturbed eigenstate, and use Eq. (21.47) to conclude that the perturbed eigenstate is also one-dimensional. In fact, it follows from (21.40) that $\mathbf{P}|a^0\rangle$ is the desired eigenstate. Denoting the latter by $|\psi\rangle$ and using Eq. (21.49), we have

$$|\psi\rangle = \mathbf{P}|a^0\rangle = \mathbf{P}_a^0|a^0\rangle + \sum_{n=1}^{\infty} \lambda^n \mathbf{A}^{(n)}|a^0\rangle = |a^0\rangle + \sum_{n=1}^{\infty} \lambda^n \mathbf{A}^{(n)}|a^0\rangle \quad (21.54)$$

because \mathbf{P}_a^0 is the projection operator onto $|a^0\rangle$.

More desirable is the energy of the perturbed state E_a , which obeys the relation $\mathbf{HP} = E_a \mathbf{P}$. Taking the trace of this relation and noting that $\text{tr} \mathbf{P} = \text{tr} \mathbf{P}_a^0 = 1$, we obtain

$$\begin{aligned}E_a &= \text{tr}(\mathbf{HP}) = \text{tr} \left(E_a^0 \mathbf{P} + \sum_{n=1}^{\infty} \lambda^n \mathbf{B}^{(n)} \right) \\ &= E_a^0 + \sum_{n=1}^{\infty} \lambda^n \underbrace{\text{tr} \mathbf{B}^{(n)}}_{\equiv \varepsilon_n} = E_a^0 + \sum_{n=1}^{\infty} \lambda^n \varepsilon_n,\end{aligned} \quad (21.55)$$

where we used Eq. (21.52). Since λ is simply a parameter to keep track of the order of perturbation, one usually includes it in the definition of the perturbing potential \mathbf{V} . The n th-order correction to the energy is then written

as

$$\varepsilon_n = \text{tr} \mathbf{B}^{(n)}. \quad (21.56)$$

Since each term of $\mathbf{B}^{(n)}$ contains \mathbf{P}_a^0 at least once, and since

$$\text{tr}(\mathbf{U}\mathbf{P}_a^0\mathbf{T}) = \text{tr}(\mathbf{T}\mathbf{U}\mathbf{P}_a^0)$$

for any pair of operators \mathbf{U} and \mathbf{T} (or products thereof), one can cast ε_n into the form of an expectation value of some product of operators in the unperturbed state $|a^0\rangle$. For example,

first-order correction to
energy

$$\varepsilon_1 = \text{tr} \mathbf{B}^{(1)} = \sum_b \langle_b^0 | \mathbf{P}_a^0 \mathbf{V} \mathbf{P}_a^0 |_b^0 \rangle = \langle_a^0 | \mathbf{V} |_a^0 \rangle \quad (21.57)$$

because $\langle_b^0 | \mathbf{P}_a^0 |_b^0 \rangle = 0$ unless $b = a$. This is the familiar expression for the **first order correction** to the energy in nondegenerate perturbation theory. Similarly,

$$\begin{aligned} \varepsilon_2 &= \text{tr} \mathbf{B}^{(2)} = -\text{tr}(\mathbf{P}_a^0 \mathbf{V} \mathbf{P}_a^0 \mathbf{V} [-\mathbf{Q}_a^0 \mathbf{G}_0^k(E_a^0) \mathbf{Q}_a^0] \\ &\quad + \mathbf{P}_a^0 \mathbf{V} [-\mathbf{Q}_a^0 \mathbf{G}_0^k(E_a^0) \mathbf{Q}_a^0] \mathbf{V} \mathbf{P}_a^0 + [-\mathbf{Q}_a^0 \mathbf{G}_0^k(E_a^0) \mathbf{Q}_a^0] \mathbf{V} \mathbf{P}_a^0 \mathbf{V} \mathbf{P}_a^0) \\ &= \langle_a^0 | \mathbf{V} \mathbf{Q}_a^0 \mathbf{G}_0^k(E_a^0) \mathbf{Q}_a^0 \mathbf{V} |_a^0 \rangle. \end{aligned}$$

The first and the last terms in parentheses give zero because in the trace sum, \mathbf{P}_a^0 gives a nonzero contribution only if the state is $|a^0\rangle$, which is precisely the state annihilated by \mathbf{Q}_a^0 . Using the completeness relation $\sum_b |b^0\rangle \langle_b^0| = \mathbf{1} = \sum_c |c^0\rangle \langle_c^0|$ for the eigenstates of the unperturbed Hamiltonian, we can rewrite ε_2 as

second-order correction
to energy

$$\varepsilon_2 = \sum_{b,c} \langle_a^0 | \mathbf{V} |_b^0 \rangle \underbrace{\langle_b^0 | \mathbf{Q}_a^0 \mathbf{G}_0^k(E_a^0) \mathbf{Q}_a^0 |_c^0 \rangle}_{\delta_{bc} / (E_a^0 - E_b^0)} \langle_c^0 | \mathbf{V} |_a^0 \rangle = \sum_{b \neq a} \frac{|\langle_a^0 | \mathbf{V} |_b^0 \rangle|^2}{E_a^0 - E_b^0}.$$

This is the familiar expression for the **second-order correction** to the energy in nondegenerate perturbation theory.

21.5.2 The Degenerate Case

The degenerate case can also start with Eqs. (21.54) and (21.55). The difference is that ε_n cannot be determined as conveniently as the nondegenerate case. For example, the expression for ε_1 will involve a sum over a basis of \mathcal{M}_a^0 because $\mathbf{P}_a^0 |_b^0 \rangle$ is no longer just $|a^0\rangle$, but some general vector in \mathcal{M}_a^0 . Instead of pursuing this line of approach, we present a more common method, which concentrates on the way \mathcal{M}_a^0 and the corresponding eigenspaces of the perturbed Hamiltonian, denoted by \mathcal{M}_a , enter in the calculation of eigenvalues and eigenvectors.

The projector \mathbf{P}_a^0 acts as a unit operator when restricted to \mathcal{M}_a^0 . In particular, it is invertible. In the limit of small λ , the projection operator \mathbf{P} is close to \mathbf{P}_a^0 ; therefore, it too must be invertible, i.e., $\mathbf{P} : \mathcal{M}_a^0 \rightarrow \mathcal{M}_a$ is an isomorphism. Similarly, $\mathbf{P}_a^0 : \mathcal{M}_a \rightarrow \mathcal{M}_a^0$ is also an isomorphism—not necessarily the inverse of the first one. It follows that for each vector in \mathcal{M}_a^0 there is a unique vector in \mathcal{M}_a and vice versa.

The eigenvalue equation $\mathbf{H}|E_a\rangle = E_a|E_a\rangle$ can thus be written as

$$\mathbf{H}\mathbf{P}_a|E_a^0\rangle = E_a\mathbf{P}_a|E_a^0\rangle,$$

where $|E_a^0\rangle$ is the unique vector mapped onto $|E_a\rangle$ by \mathbf{P}_a . Multiplying both sides by \mathbf{P}_a^0 , we obtain

$$\mathbf{P}_a^0\mathbf{H}\mathbf{P}_a|E_a^0\rangle = E_a\mathbf{P}_a^0\mathbf{P}_a|E_a^0\rangle,$$

which is completely equivalent to the previous equation because \mathbf{P}_a^0 is invertible. If we define

$$\mathbf{H}_a \equiv \mathbf{P}_a^0\mathbf{H}\mathbf{P}_a\mathbf{P}_a^0 : \mathcal{M}_a^0 \rightarrow \mathcal{M}_a^0, \quad \mathbf{K}_a \equiv \mathbf{P}_a^0\mathbf{P}_a\mathbf{P}_a^0 : \mathcal{M}_a^0 \rightarrow \mathcal{M}_a^0, \quad (21.58)$$

the preceding equation becomes

$$\mathbf{H}_a|E_a^0\rangle = E_a\mathbf{K}_a|E_a^0\rangle. \quad (21.59)$$

As operators on \mathcal{M}_a^0 both \mathbf{H}_a and \mathbf{K}_a are hermitian. In fact, \mathbf{K}_a , which can be written as the product of $\mathbf{P}_a^0\mathbf{P}_a$ and its hermitian conjugate, is a positive definite operator. Equation (21.59) is a generalized eigenvalue equation whose eigenvalues E_a are solutions of the equation

$$\det(\mathbf{H}_a - x\mathbf{K}_a) = 0. \quad (21.60)$$

The eigenvectors of this equation, once projected onto \mathcal{M}_a by \mathbf{P}_a , give the desired eigenvectors of \mathbf{H} .

The expansions of \mathbf{H}_a and \mathbf{K}_a are readily obtained from those of $\mathbf{H}\mathbf{P}_a$ and \mathbf{P}_a as given in Eqs. (21.49) and (21.52). We give the first few terms of each expansion:

$$\begin{aligned} \mathbf{K}_a &= \mathbf{P}_a^0 - \lambda^2\mathbf{P}_a^0\mathbf{V}\mathbf{Q}_a^0\mathbf{G}_0^2(E_a^0)\mathbf{Q}_a^0\mathbf{V}\mathbf{P}_a^0 + \dots, \\ \mathbf{H}_a &= E_a^0\mathbf{K}_a + \lambda\mathbf{P}_a^0\mathbf{V}\mathbf{P}_a^0 + \lambda^2\mathbf{P}_a^0\mathbf{V}\mathbf{Q}_a^0\mathbf{G}_0(E_a^0)\mathbf{Q}_a^0\mathbf{V}\mathbf{P}_a^0 + \dots. \end{aligned} \quad (21.61)$$

To any given order of approximation, the eigenvalues E_a are obtained by terminating the series in (21.61) at that order, plugging the resulting finite sum in Eq. (21.60), and solving the determinant equation.

21.6 Problems

21.1 Show that the definitions of the three types of SOPDEs discussed in Example 21.1.6 are equivalent to the definitions based on Eq. (21.5). Hint: Diagonalize the matrix of coefficients of the SOPDE:

$$a\frac{\partial^2 u}{\partial x^2} + 2b\frac{\partial^2 u}{\partial x\partial y} + c\frac{\partial^2 u}{\partial y^2} + F\left(x, y, u, \frac{\partial u}{\partial x}, \frac{\partial u}{\partial y}\right) = 0,$$

where a , b , and c are functions of x and y . Write the eigenvalues as $(a + c \pm \Delta)/2$ and consider the three cases $|\Delta| < |a + c|$, $|\Delta| > |a + c|$, and $|\Delta| = |a + c|$.

21.2 Find the characteristic curves for $\mathbf{L}_x[u] = \partial u / \partial x$.

21.3 Find the characteristic curves for the two-dimensional wave equation and the two-dimensional diffusion equation.

21.4 Solve the Cauchy problem for the two-dimensional Laplace equation subject to the Cauchy data $u(0, y) = 0$, $(\partial u / \partial x)(0, y) = \epsilon \sin ky$, where ϵ and k are constants. Show that the solution does not vary continuously as the Cauchy data vary. In particular, show that for any $\epsilon \neq 0$ and any preassigned $x > 0$, the solution $u(x, y)$ can be made arbitrarily large by choosing k large enough.

21.5 Show that the x_i in Eq. (21.12) describe an m -dimensional sphere of radius r , that is, $\sum_{i=1}^m x_i^2 = r^2$.

21.6 Use $J\delta(\mathbf{x} - \mathbf{a}) = \delta(\boldsymbol{\xi} - \boldsymbol{\alpha})$ and the coordinate transformation from the spherical coordinate system to Cartesian coordinates to express the 3D Cartesian delta function in terms of the corresponding spherical delta function at a point $P = (x_0, y_0, z_0) = (r_0, \theta_0, \varphi_0)$ where the Jacobian J is non-vanishing.

21.7 Find the volume of an m -dimensional sphere.

21.8 Prove Eq. (21.11). First, note that the RHS of Eq. (21.10) is a function of only k of the α 's. This means that

$$H(\boldsymbol{\xi})|_{\boldsymbol{\xi}=\boldsymbol{\alpha}} = H(\alpha_1, \dots, \alpha_k).$$

(a) Rewrite Eq. (21.10) by separating the integral into two parts, one involving $\{\xi_i\}_{i=1}^k$ and the other involving $\{\xi_i\}_{i=k+1}^m$. Compare the RHS with the LHS and show that

$$\int J d\xi_{k+1} \cdots d\xi_m \delta(\mathbf{x} - \mathbf{a}) = \prod_{i=1}^k \delta(\xi_i - \alpha_i).$$

(b) Show that this equation implies that $\delta(\mathbf{x} - \mathbf{a})$ is independent of $\{\xi_i\}_{i=k+1}^m$. Thus, one can take the delta function out of the integral.

21.9 Find the m -dimensional Green's function for the Laplacian as follows.

(a) Solve Eq. (21.19) assuming that $r \neq 0$ and demanding that $G(r) \rightarrow 0$ as $r \rightarrow \infty$ (this can be done only for $m \geq 3$).

- (b) Use the divergence theorem in m dimensions and (21.18) to show that

$$\iint_S \frac{dG}{dr} da = 1,$$

where S is a spherical hypersurface of radius r . Now use this and the result of part (a) to find the remaining constant of integration.

21.10 Consider the operator $\mathbf{L}_x = \nabla^2 + \mathbf{b} \cdot \nabla + c$ for which $\{b_i\}_{i=1}^m$ and c are functions of $\{x_i\}_{i=1}^m$.

- (a) Show that $\mathbf{L}_x^\dagger[v] = \nabla^2 v - \nabla \cdot (\mathbf{b}v) + cv$, and

$$\mathbf{Q}[u, v^*] = \mathbf{Q}[u, v] = v \nabla u - u \nabla v + \mathbf{b}uv.$$

- (b) Show that a necessary condition for \mathbf{L}_x to be self-adjoint is $2\mathbf{b} \cdot \nabla u + u(\nabla \cdot \mathbf{b}) = 0$ for arbitrary u .
 (c) By choosing some u 's judiciously, show that (b) implies that $b_i = 0$. Conclude that $\mathbf{L}_x = \nabla^2 + c(\mathbf{x})$ is formally self-adjoint.

21.11 Solve the integral form of the Schrödinger equation for an attractive double delta-function potential

$$V(x) = -V_0[\delta(x - a_1) + \delta(x - a_2)], \quad V_0 > 0.$$

Find the eigenfunctions and obtain a transcendental equation for the eigenvalues (see Example 21.4.1).

21.12 Show that the integral equation associated with the damped harmonic oscillator DE $\ddot{x} + 2\gamma\dot{x} + \omega_0^2 x = 0$, having the BCs $x(0) = x_0$, $(dx/dt)_{t=0} = 0$, can be written in either of the following forms.

$$(a) \quad x(t) = x_0 - \frac{\omega_0^2}{2\gamma} \int_0^t [1 - e^{-2\gamma(t-t')}] x(t') dt'.$$

$$(b) \quad x(t) = x_0 \cos \omega_0 t + \frac{2\gamma x_0}{\omega_0} \sin \omega_0 t - 2\gamma \int_0^t \cos[\omega_0(t-t')] x(t') dt'.$$

Hint: Take $\omega_0^2 x$ or $2\gamma\dot{x}$, respectively, as the inhomogeneous term.

21.13 Show that for scattering problems ($E > 0$)

- (a) the integral form of the Schrödinger equation in one dimension is

$$\Psi(x) = e^{ikx} - \frac{i\mu}{\hbar^2 k} \int_{-\infty}^{\infty} e^{ik|x-y|} V(y) \Psi(y) dy.$$

- (b) Divide $(-\infty, +\infty)$ into three regions $R_1 = (-\infty, -a)$, $R_2 = (-a, +a)$ and $R_3 = (a, \infty)$. Let $\psi_i(x)$ be $\psi(x)$ in region R_i . Assume that the potential $V(x)$ vanishes in R_1 and R_3 . Show that

$$\psi_1(x) = e^{ikx} - \frac{i\mu}{\hbar^2 k} e^{-ikx} \int_{-a}^a e^{iky} V(y) \psi_2(y) dy,$$

$$\psi_2(x) = e^{ikx} - \frac{i\mu}{\hbar^2 k} \int_{-a}^a e^{ik|x-y|} V(y) \psi_2(y) dy,$$

$$\psi_3(x) = e^{ikx} - \frac{i\mu}{\hbar^2 k} e^{ikx} \int_{-a}^a e^{-iky} V(y) \psi_2(y) dy.$$

This shows that determining the wave function in regions where there is no potential requires the wave function in the region where the potential acts.

(c) Let

$$V(x) = \begin{cases} V_0 & \text{if } |x| < a, \\ 0 & \text{if } |x| > a, \end{cases}$$

and find $\psi_2(x)$ by the method of successive approximations. Show that the n th term is less than $(2\mu V_0 a / \hbar^2 k)^{n-1}$ (so the Neumann series will converge) if $(2V_0 a / \hbar v) < 1$, where v is the velocity and $\mu v = \hbar k$ is the momentum of the wave. Therefore, for large velocities, the Neumann series expansion is valid.

21.14 (a) Show that $\mathbf{H}\mathbf{R}_z(\mathbf{H}) = \mathbf{1} + z\mathbf{R}_z(\mathbf{H})$. (b) Use (a) to prove Eq. (21.43).

The previous chapter gathered together some general properties of the GFs and their companion, the Dirac delta function. This chapter considers the Green's functions for elliptic, parabolic, and hyperbolic equations that satisfy the BCs appropriate for each type of PDE.

22.1 Elliptic Equations

The most general linear PDE in m variables of the elliptic type was discussed in Sect. 21.1.2. We will not discuss this general case, because all elliptic PDOs encountered in mathematical physics are of a much simpler nature. In fact, the self-adjoint elliptic PDO of the form $\mathbf{L}_x = \nabla^2 + q(\mathbf{x})$ is sufficiently general for purposes of this discussion. Recall from Sect. 21.1.2 that the BCs associated with an elliptic PDE are of two types, Dirichlet and Neumann. Let us consider these separately.

22.1.1 The Dirichlet Boundary Value Problem

A Dirichlet BVP consists of an elliptic PDE together with a Dirichlet BC, such as

$$\begin{aligned}\mathbf{L}_x[u] &= \nabla^2 u + q(\mathbf{x})u = f(\mathbf{x}) \quad \text{for } \mathbf{x} \in D, \\ u(\mathbf{x}_b) &= g(\mathbf{x}_b) \quad \text{for } \mathbf{x}_b \in \partial D,\end{aligned}\tag{22.1}$$

where $g(\mathbf{x}_b)$ is a given function defined on the closed hypersurface ∂D .

The Green's function for the Dirichlet BVP must satisfy the *homogeneous* BC, for the same reason as in the one-dimensional Green's function. Thus, the Dirichlet Green's function, denoted by $G_D(\mathbf{x}, \mathbf{y})$, must satisfy

$$\mathbf{L}_x[G_D(\mathbf{x}, \mathbf{y})] = \delta(\mathbf{x} - \mathbf{y}), \quad G_D(\mathbf{x}_b, \mathbf{y}) = 0 \text{ for } \mathbf{x}_b \in S.$$

As discussed in Sect. 21.3.2, we can separate G_D into a singular part $G_D^{(s)}$ and a regular part H where $G_D^{(s)}$ satisfies the same DE as G_D and H satisfies the corresponding homogeneous DE and the BC $H(\mathbf{x}_b, \mathbf{y}) = -G_D^{(s)}(\mathbf{x}_b, \mathbf{y})$.

Using Eq. (22.1) and the properties of $G_D(x, y)$ in Eq. (21.27), we obtain

$$u(\mathbf{x}) = \int_D d^m y G_D(\mathbf{x}, \mathbf{y}) f(\mathbf{y}) + \int_{\partial D} g(\mathbf{y}_b) \frac{\partial G_D}{\partial n_y}(\mathbf{x}, \mathbf{y}_b) da, \quad (22.2)$$

where $\partial/\partial n_y$ indicates normal differentiation with respect to the second argument.

Historical Notes



Gustav Peter Lejeune
Dirichlet 1805–1859

Gustav Peter Lejeune Dirichlet (1805–1859), the son of a postmaster, first attended public school, then a private school that emphasized Latin. He was precociously interested in mathematics; it is said that before the age of twelve he used his pocket money to buy mathematical books. In 1817 he entered the gymnasium in Bonn. He is reported to have been an unusually attentive and well-behaved pupil who was particularly interested in modern history as well as in mathematics.

After two years in Bonn, Dirichlet was sent to a Jesuit college in Cologne that his parents preferred. Among his teachers was the physicist Georg Simon Ohm, who gave him a thorough grounding in theoretical physics. Dirichlet completed his *Abitur* examination at the very early age of sixteen. His parents wanted him to study law, but mathematics was already his chosen field. At the time the level of pure mathematics in the German universities was at a low ebb: Except for the formidable Carl Gauss, in Göttingen, there were no outstanding mathematicians, while in Paris the firmament was studded by such luminaries as P.-S. Laplace, Adrien Legendre, Joseph Fourier, and Siméon Poisson.

Dirichlet arrived in Paris in May 1822. In the summer of 1823 he was fortunate in being appointed to a well-paid and pleasant position as tutor to the children of General Maximilien Fay, a national hero of the Napoleonic wars and then the liberal leader of the opposition in the Chamber of Deputies. Dirichlet was treated as a member of the family and met many of the most prominent figures in French intellectual life. Among the mathematicians, he was particularly attracted to Fourier, whose ideas had a strong influence upon his later works on trigonometric series and mathematical physics.

General Fay died in November 1825, and the next year Dirichlet decided to return to Germany, a plan strongly supported by Alexander von Humboldt, who was working for the strengthening of the natural sciences in Germany. Dirichlet was permitted to qualify for habilitation as Privatdozent at the University of Breslau; since he did not have the required doctorate, this was awarded honoris causa by the University of Cologne. His habilitation thesis dealt with polynomials whose prime divisors belong to special arithmetic series. A second paper from this period was inspired by Gauss's announcements on the biquadratic law of reciprocity.

Dirichlet was appointed extraordinary professor in Breslau, but the conditions for scientific work were not inspiring. In 1828 he moved to Berlin, again with the assistance of Humboldt, to become a teacher of mathematics at the military academy. Shortly afterward, at the age of twenty-three, he was appointed extraordinary (later ordinary) professor at the University of Berlin. In 1831 he became a member of the Berlin Academy of Sciences, and in the same year he married Rebecca Mendelssohn-Bartholdy, sister of Felix Mendelssohn, the composer.

Dirichlet spent twenty-seven years as a professor in Berlin and exerted a strong influence on the development of German mathematics through his lectures, through his many pupils, and through a series of scientific papers of the highest quality that he published during this period. He was an excellent teacher, always expressing himself with great clarity. His manner was modest; in his later years he was shy and at times reserved. He seldom spoke at meetings and was reluctant to make public appearances. In many ways he was a direct contrast to his lifelong friend, the mathematician Karl Gustav Jacobi.

One of Dirichlet's most important papers, published in 1850, deals with the boundary value problem, now known as *Dirichlet's boundary value problem*, in which one wishes to determine a potential function satisfying Laplace's equation and having prescribed values on a given surface, in Dirichlet's case a sphere.

In 1855, when Gauss died, the University of Göttingen was anxious to seek a successor of great distinction, and the choice fell upon Dirichlet. Dirichlet moved to Göttingen in the fall of 1855, bought a house with a garden, and seemed to enjoy the quieter life of

a prominent university in a small city. He had a number of excellent pupils and relished the increased leisure for research. His work in this period was centered on general problems of mechanics. This new life, however, was not to last long. In the summer of 1858 Dirichlet traveled to a meeting in Montreux, Switzerland, to deliver a memorial speech in honor of Gauss. While there, he suffered a heart attack and was barely able to return to his family in Göttingen. During his illness his wife died of a stroke, and Dirichlet himself died the following spring.

Some special cases of (22.2) are worthy of mention.

1. The first is $u(\mathbf{x}_b) = 0$, the solution to an inhomogeneous DE satisfying the homogeneous BC. We obtain this by substituting zero for $g(\mathbf{x}_b)$ in (22.2) so that only the integration over D remains.
2. The second special case is when the DE is homogeneous, that is, when $f(\mathbf{x}) = 0$ but the BC is inhomogeneous. This yields an integration over the boundary ∂D alone.
3. Finally, the solution to the homogeneous DE with the homogeneous BC is simply $u = 0$, referred to as the zero solution. This is consistent with physical intuition: If the function is zero on the boundary and there is no source $f(\mathbf{x})$ to produce any “disturbance,” we expect no nontrivial solution.

Example 22.1.1 (Method of Images and Dirichlet BVP) Let us find the Green’s function for the three-dimensional Laplacian $\mathbf{L}_x = \nabla^2$ satisfying the Dirichlet BC $G_D(\boldsymbol{\rho}, \mathbf{y}) = 0$ for $\boldsymbol{\rho}$, on the xy -plane. Here D is the upper half-space ($z \geq 0$) and ∂D is the xy -plane.

method of images and Dirichlet BVP

It is more convenient to use $\mathbf{r} = (x, y, z)$ and $\mathbf{r}' = (x', y', z')$ instead of \mathbf{x} and \mathbf{y} , respectively. Using (21.21) as $G_D^{(s)}$, we can write

$$\begin{aligned} G_D(\mathbf{r}, \mathbf{r}') &= -\frac{1}{4\pi|\mathbf{r} - \mathbf{r}'|} + H(\mathbf{r}, \mathbf{r}') \\ &= -\frac{1}{4\pi} \frac{1}{\sqrt{(x - x')^2 + (y - y')^2 + (z - z')^2}} \\ &\quad + H(x, y, z; x', y', z'). \end{aligned}$$

The requirement that G_D vanish on the xy -plane gives

$$H(x, y, 0; x', y', z') = \frac{1}{4\pi} \frac{1}{\sqrt{(x - x')^2 + (y - y')^2 + z'^2}}.$$

This fixes the dependence of H on all variables except z . On the other hand, $\nabla^2 H = 0$ in D implies that the form of H must be the same as that of $G_D^{(s)}$ because except at $\mathbf{r} = \mathbf{r}'$, the latter does satisfy Laplace’s equation. Thus, because of the symmetry of $G_D^{(s)}$ in \mathbf{r} and \mathbf{r}' [$G_D(\mathbf{r}, \mathbf{r}') = G_D(\mathbf{r}', \mathbf{r})$] and the evenness of the Laplacian in z (as well as x and y), we have two choices for the z -dependence: $(z - z')^2$ and $(z + z')^2$. The first gives $G_D = 0$, which is a trivial solution. Thus, we must choose

$$H(x, y, z; x', y', z') = \frac{1}{4\pi} \frac{1}{\sqrt{(x - x')^2 + (y - y')^2 + (z + z')^2}}.$$

Note that with $\mathbf{r}'' \equiv (x', y', -z')$, this equation satisfies $\nabla^2 H = -\delta(\mathbf{r} - \mathbf{r}'')$, and it may appear that H does not satisfy the homogeneous DE, as it should. However, \mathbf{r}'' is outside D , and $\mathbf{r} \neq \mathbf{r}''$ as long as $\mathbf{r} \in D$. So H does satisfy the homogeneous DE in D . The Green's function for the given Dirichlet BC is therefore

$$G_D(\mathbf{r}, \mathbf{r}') = -\frac{1}{4\pi} \left(\frac{1}{|\mathbf{r} - \mathbf{r}'|} - \frac{1}{|\mathbf{r} - \mathbf{r}''|} \right),$$

where \mathbf{r}'' is the *reflection* of \mathbf{r}' in the xy -plane.

This result has a direct physical interpretation. If determining the solution of the Laplace equation is considered a problem in electrostatics, then $G_D^{(s)}(\mathbf{r}, \mathbf{r}')$ is simply the potential at \mathbf{r} of a unit point charge located at \mathbf{r}' , and $G_D(\mathbf{r}, \mathbf{r}')$ is the potential of two point charges of opposite signs, one at \mathbf{r}' and the other at the mirror image of \mathbf{r}' . The fact that the two charges are equidistant from the xy -plane ensures the vanishing of the potential in that plane. The introduction of image charges to ensure the vanishing of G_D at ∂D is common in electrostatics and is known as the **method of images**. This method reduces the Dirichlet problem for the Laplacian to finding appropriate point charges outside D that guarantee the vanishing of the potential on ∂D . For simple geometries, such as the one discussed in this example, determination of the magnitudes and locations of such image charges is easy, rendering the method extremely useful.

Having found the Green's function, we can pose the general Dirichlet BVP:

$$\nabla^2 u = -\rho(\mathbf{r}) \quad \text{and} \quad u(x, y, 0) = g(x, y), \quad \text{for } z > 0.$$

The solution is

$$\begin{aligned} u(\mathbf{r}) = & \frac{1}{4\pi} \int_{-\infty}^{\infty} dx' \int_{-\infty}^{\infty} dy' \int_0^{\infty} dz' \rho(\mathbf{r}') \left(\frac{1}{|\mathbf{r} - \mathbf{r}'|} - \frac{1}{|\mathbf{r} - \mathbf{r}''|} \right) \\ & + \int_{-\infty}^{\infty} dx' \int_{-\infty}^{\infty} dy' g(x', y') \left. \frac{\partial G_D}{\partial z} \right|_{z=0}, \end{aligned} \quad (22.3)$$

where $\mathbf{r} = (x, y, z)$, $\mathbf{r}' = (x', y', z')$, and $\mathbf{r}'' = (x', y', -z')$.

A typical application consists in introducing a number of charges in the vicinity of an infinite conducting sheet, which is held at a constant potential V_0 . If there are N charges, $\{q_i\}_{i=1}^N$, located at $\{\mathbf{r}_i\}_{i=1}^N$, then $\rho(\mathbf{r}) = \sum_{i=1}^N q_i \delta(\mathbf{r} - \mathbf{r}_i)$, $g(x, y) = \text{const} = V_0$, and we get

$$u(\mathbf{r}) = \sum_{i=1}^N \frac{1}{4\pi} \left(\frac{q_i}{|\mathbf{r} - \mathbf{r}_i|} - \frac{q_i}{|\mathbf{r} - \mathbf{r}'_i|} \right) + V_0 \int_{-\infty}^{\infty} dx' \int_{-\infty}^{\infty} dy' \left. \frac{\partial G_D}{\partial z} \right|_{z=0}, \quad (22.4)$$

where $\mathbf{r}_i = (x_i, y_i, z_i)$ and $\mathbf{r}'_i = (x_i, y_i, -z_i)$. That the double integral in Eq. (22.4) is unity can be seen by direct integration or by noting that the sum vanishes when $z = 0$. On the other hand, $u(x, y, 0) = V_0$. Thus, the

solution becomes

$$u(\mathbf{r}) = \sum_{i=1}^N \frac{1}{4\pi} \left(\frac{q_i}{|\mathbf{r} - \mathbf{r}_i|} - \frac{q_i}{|\mathbf{r} - \mathbf{r}'_i|} \right) + V_0.$$

Example 22.1.2 (Dirichlet BVP for a Sphere) The method of images is also applicable when the boundary is a sphere. Inside a sphere of radius a with center at the origin, we wish to solve this Dirichlet BVP:

Dirichlet BVP for a sphere

$$\nabla^2 u = -\rho(r, \theta, \varphi) \quad \text{for } r < a, \quad \text{and} \quad u(a, \theta, \varphi) = g(\theta, \varphi).$$

The GF satisfies

$$\begin{aligned} \nabla^2 G_D(r, \theta, \varphi; r', \theta', \varphi') &= \delta(\mathbf{r} - \mathbf{r}') \quad \text{for } r < a, \\ G_D(a, \theta, \varphi; r', \theta', \varphi') &= 0. \end{aligned} \tag{22.5}$$

Thus, G_D can again be interpreted as the potential of point charges, of which one is in the sphere and the others are outside.

We write $G_D = G_D^{(s)} + H$ and choose H in such a way that the second equation in (22.5) is satisfied. As in the case of the xy -plane, let¹ $H(\mathbf{r}, \mathbf{r}'') = -\frac{k}{4\pi|\mathbf{r} - \mathbf{r}''|}$, where k is a constant to be determined. If \mathbf{r}'' is *outside* the sphere, $\nabla^2 H$ will vanish everywhere *inside* the sphere. The problem has been reduced to finding k and \mathbf{r}'' (the location of the image charge). We want to choose \mathbf{r}'' such that

$$\left. \frac{1}{|\mathbf{r} - \mathbf{r}''|} \right|_{r=a} = \left. \frac{k}{|\mathbf{r} - \mathbf{r}''|} \right|_{r=a} \quad \Rightarrow \quad k(|\mathbf{r} - \mathbf{r}'|)_{r=a} = (|\mathbf{r} - \mathbf{r}''|)_{r=a}.$$

This shows that k must be positive. Squaring both sides and expanding the result yields

$$k^2(a^2 + r'^2 - 2ar' \cos \gamma) = a^2 + r''^2 - 2ar'' \cos \gamma,$$

where γ is the angle between \mathbf{r} and \mathbf{r}' , and we have assumed that \mathbf{r}' and \mathbf{r}'' are in the same direction. If this equation is to hold for arbitrary γ , we must have $k^2 r' = r''$ and $k^2(a^2 + r'^2) = a^2 + r''^2$. Combining these two equations yields $k^4 r'^2 - k^2(a^2 + r'^2) + a^2 = 0$, whose positive solutions are $k = 1$ and $k = a/r$. The first choice implies that $r'' = r'$, which is impossible because r'' must be outside the sphere. We thus choose $k = a/r'$, which gives $\mathbf{r}'' = (a^2/r'^2)\mathbf{r}'$. We then have

$$G_D(\mathbf{r}, \mathbf{r}') = -\frac{1}{4\pi} \left[\frac{1}{|\mathbf{r} - \mathbf{r}'|} - \frac{ar'}{|r'^2 \mathbf{r} - a^2 \mathbf{r}'|} \right]. \tag{22.6}$$

¹ Actually, to be general, we must add an arbitrary function $f(\mathbf{r}'')$ to this. However, as the reader can easily verify, the following argument will show that $f(\mathbf{r}'') = 0$. Besides, we are only interested in a solution, not the most general one. All simplifying assumptions that follow are made for the same reason.

Substituting this in Eq. (22.2), and noting that $\partial G/\partial n_y = (\partial G/\partial r')_{r'=a}$, yields

$$\begin{aligned} u(\mathbf{r}) &= \frac{1}{4\pi} \int_0^a r'^2 dr' \int_0^\pi \sin \theta' d\theta' \\ &\quad \times \int_0^{2\pi} \left(\frac{1}{|\mathbf{r} - \mathbf{r}'|} - \frac{ar'}{|r'^2 \mathbf{r} - a^2 \mathbf{r}'|} \right) \rho(\mathbf{r}') d\varphi' \\ &\quad + \frac{a(a^2 - r^2)}{4\pi} \int_0^{2\pi} d\varphi' \int_0^\pi \sin \theta' d\theta' \frac{g(\theta', \varphi')}{|\mathbf{r} - \mathbf{a}|^3}, \end{aligned} \quad (22.7)$$

where $\mathbf{a} = (a, \theta', \varphi')$ is a vector from the origin to a point on the sphere. For the Laplace equation $\rho(\mathbf{r}') = 0$, and only the double integral in Eq. (22.7) will contribute.

It can be shown that if $g(\theta', \varphi') = \text{const} = V_0$, then $u(\mathbf{r}) = V_0$. This is the familiar fact shown in electromagnetism: If the potential on a sphere is kept constant, the potential inside the sphere will be constant and equal to the potential at the surface.

Dirichlet BVP for a circle

Example 22.1.3 (Dirichlet BVP for a Circle) In this example we find the Dirichlet GF for a circle of radius a centered at the origin. The GF is logarithmic [see Eq. (21.22)]. Therefore, H is also logarithmic, and its most general form is

$$H(\mathbf{r}, \mathbf{r}'') = -\frac{1}{2\pi} \ln(|\mathbf{r} - \mathbf{r}''|) - \frac{1}{2\pi} \ln[f(\mathbf{r}'')] = -\frac{1}{2\pi} \ln(|\mathbf{r} - \mathbf{r}''| f(\mathbf{r}'')),$$

so that

$$\begin{aligned} G_D(\mathbf{r}, \mathbf{r}') &= \frac{1}{2\pi} \ln(|\mathbf{r} - \mathbf{r}'|) - \frac{1}{2\pi} \ln(|\mathbf{r} - \mathbf{r}''| f(\mathbf{r}'')) \\ &= \frac{1}{2\pi} \ln \left| \frac{\mathbf{r} - \mathbf{r}'}{(\mathbf{r} - \mathbf{r}'') f(\mathbf{r}'')} \right|. \end{aligned}$$

For G_D to vanish at all points on the circle, we must have

$$\left| \frac{\mathbf{a} - \mathbf{r}'}{(\mathbf{a} - \mathbf{r}'') f(\mathbf{r}'')} \right| = 1 \quad \Rightarrow \quad |\mathbf{a} - \mathbf{r}'| = |(\mathbf{r} - \mathbf{r}'') f(\mathbf{r}'')|,$$

where \mathbf{a} is a vector from origin to a point on the circle. Assuming that \mathbf{r}'' and \mathbf{r}' are in the same direction, squaring both sides of the last equation and expanding the result, we obtain

$$(a^2 + r''^2 - 2ar'' \cos \gamma) f^2(\mathbf{r}'') = a^2 + r'^2 - 2ar' \cos \gamma,$$

where γ is the angle between \mathbf{a} and \mathbf{r}' (or \mathbf{r}''). This equation must hold for arbitrary γ . Hence, we have $f^2(\mathbf{r}'') r'' = r'$ and $f^2(\mathbf{r}'') (a^2 + r''^2) = a^2 + r'^2$. These can be solved for $f(\mathbf{r}'')$ and \mathbf{r}'' . The result is

$$\mathbf{r}'' = \frac{a^2}{r'^2} \mathbf{r}', \quad f(\mathbf{r}'') = \frac{a}{r''} = \frac{r'}{a}.$$

Substituting these formulas in the expression for G_D , we obtain

$$G_D(\mathbf{r}, \mathbf{r}') = \frac{1}{2\pi} \ln(|\mathbf{r} - \mathbf{r}'|) - \frac{1}{2\pi} \ln\left(\left|\mathbf{r} - \frac{a^2}{r'^2} \mathbf{r}'\right| \frac{r'}{a}\right).$$

To write the solution to the Dirichlet BVP, we also need $\partial G_D / \partial n = \partial G_D / \partial r'$. Using polar coordinates, we express G_D as

$$G_D(\mathbf{r}, \mathbf{r}') = \frac{1}{4\pi} \ln\left|\frac{r^2 + r'^2 - 2rr' \cos(\theta - \theta')}{r^2 r'^2 / a^2 + a^2 - 2rr' \cos(\theta - \theta')}\right|.$$

Differentiation with respect to r' yields

$$\frac{\partial G_D}{\partial n}\bigg|_{r'=a} = \frac{\partial G_D}{\partial r'}\bigg|_{r'=a} = \frac{1}{2\pi a} \frac{a^2 - r^2}{r^2 + a^2 - 2ra \cos(\theta - \theta')},$$

from which we can immediately write the solution to the two-dimensional Dirichlet BVP $\nabla^2 u = \rho$, $u(r = a) = g(\theta')$ as

$$u(\mathbf{r}) = \int_0^{2\pi} d\theta' \int_0^a r' G_D(\mathbf{r}, \mathbf{r}') \rho(\mathbf{r}') dr' + \frac{a^2 - r^2}{2\pi a} \int_0^{2\pi} d\theta' \frac{g(\theta')}{r^2 + a^2 - 2ra \cos(\theta - \theta')}.$$

In particular, for Laplace's equation $\rho(\mathbf{r}') = 0$, and we get

$$u(r, \theta) = \frac{a^2 - r^2}{2\pi a} \int_0^{2\pi} d\theta' \frac{g(\theta')}{r^2 + a^2 - 2ra \cos(\theta - \theta')}. \quad (22.8)$$

Poisson integral formula

Equation (22.8) is called the **Poisson integral formula**.

22.1.2 The Neumann Boundary Value Problem

The Neumann BVP is not as simple as the Dirichlet BVP because it requires the normal derivative of the solution. But the normal derivative is related to the Laplacian through the divergence theorem. Thus, the BC and the DE are tied together, and unless we impose some solvability conditions, we may have no solution at all. These points are illustrated clearly if we consider the Laplacian operator.

Historical Notes

Carl Gottfried Neumann (1832–1925) was the son of Franz Ernst Neumann, a professor of physics and mineralogy at Königsberg; his mother, Luise Florentine Hagen, was a sister-in-law of the astronomer Bessel. Neumann received his primary and secondary education in Königsberg, attended the university, and formed particularly close friendships with the analyst F.J. Richelot and the geometer L.O. Hesse. After passing the examination for secondary-school teaching, he obtained his doctorate in 1855; in 1858 he qualified for lecturing in mathematics at Halle, where he became Privatdozent and, in 1863, assistant professor. In the latter year he was called to Basel, and in 1865 to Tübingen. From the

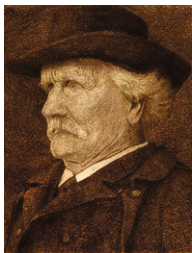

Carl Gottfried Neumann
1832–1925

autumn of 1868 until his retirement in 1911 he was at the University of Leipzig. In 1864 he married Hermine Mathilde Elise Kloss; she died in 1875.

Neumann, who led a quiet life, was a successful university teacher and a productive researcher. More than two generations of future gymnasium teachers received their basic mathematical education from him. As a researcher he was especially prominent in the field of potential theory. His investigations into *boundary value problems* resulted in pioneering achievements; in 1870 he began to develop the method of the arithmetical mean for their solution. He also coined the term “logarithmic potential.” The second boundary value problem of potential theory still bears his name; a generalization of it was later provided by H. Poincaré.

Neumann was a member of the Berlin Academy and the Societies of Göttingen, Munich, and Leipzig. He performed a valuable service in founding and editing the important German mathematics periodical *Mathematische Annalen*.

Consider the Neumann BVP

$$\nabla^2 u = f(\mathbf{x}) \quad \text{for } \mathbf{x} \in D, \quad \text{and} \quad \frac{\partial u}{\partial n} = g(\mathbf{x}) \quad \text{for } \mathbf{x} \in \partial D.$$

Integrating the first equation over D and using the divergence theorem, we obtain

$$\int_D f(\mathbf{x}) d^m x = \int_D \nabla \cdot (\nabla u) d^m x = \int_{\partial D} \hat{\mathbf{e}}_n \cdot \nabla u da = \int_{\partial D} \frac{\partial u}{\partial n} da.$$

It follows that we cannot arbitrarily assign values of $\partial u / \partial n$ on the boundary. In particular, if the BC is homogeneous, as in the case of Green’s functions, the RHS is zero, and we must have $\int_D f(\mathbf{x}) d^m x = 0$. This relation is a restriction on the DE, and is a solvability condition, as mentioned above. To satisfy this condition, it is necessary to subtract from the inhomogeneous term its average value over the region D . Thus, if V_D is the volume of the region D , then

$$\nabla^2 u = f(\mathbf{x}) - \bar{f} \quad \text{where} \quad \bar{f} = \frac{1}{V_D} \int_D f(\mathbf{x}) d^m x$$

ensures that the Neumann BVP is solvable. In particular, the inhomogeneous term for the Green’s function is not simply $\delta(\mathbf{x} - \mathbf{y})$ but $\delta(\mathbf{x} - \mathbf{y}) - \bar{\delta}$, where

$$\bar{\delta} = \frac{1}{V_D} \int_D \delta(\mathbf{x} - \mathbf{y}) d^m x = \frac{1}{V_D} \quad \text{if } \mathbf{y} \in D.$$

Thus, the Green’s function for the Neumann BVP, $G_N(\mathbf{x}, \mathbf{y})$, satisfies

$$\begin{aligned} \nabla^2 G_N(\mathbf{x}, \mathbf{y}) &= \delta(\mathbf{x} - \mathbf{y}) - \frac{1}{V_D}, \\ \frac{\partial G_N}{\partial n}(\mathbf{x}, \mathbf{y}) &= 0 \quad \text{for } \mathbf{x} \in \partial D. \end{aligned}$$

Applying Green’s identity, Eq. (21.27), we get

$$u(\mathbf{x}) = \int_D d^m y G_N(\mathbf{x}, \mathbf{y}) f(\mathbf{y}) - \int_{\partial D} G_N(\mathbf{x}, \mathbf{y}) \frac{\partial u}{\partial n} da + \bar{u}, \quad (22.9)$$

where $\bar{u} = (1/V_D) \int_D u(\mathbf{x}) d^m x$ is the average value of u in D . Equation (22.9) is valid only for the Laplacian operator, although a similar result can be obtained for a general self-adjoint SOLPDO with constant coefficients. We will not pursue that result, however, since it is of little practical use.

Throughout the discussion so far we have assumed that D is bounded; that is, we have considered points inside D with BCs on the boundary ∂D specified. This is called an **interior BVP**. In many physical situations we are interested in points outside D . We are then dealing with an **exterior BVP**. In dealing with such a problem, we must specify the behavior of the Green's function at infinity. In most cases, the physics of the problem dictates such behavior. For instance, for the case of an exterior Dirichlet BVP, where

interior vs exterior BVP

$$u(\mathbf{x}) = \int_D d^m y G_D(\mathbf{x}, \mathbf{y}) f(\mathbf{y}) + \int_{\partial D} u(\mathbf{y}_b) \frac{\partial G_D}{\partial n_y}(\mathbf{x}, \mathbf{y}_b) da$$

and it is desired that $u(\mathbf{x}) \rightarrow 0$ as $|\mathbf{x}| \rightarrow \infty$, the vanishing of $G_D(\mathbf{x}, \mathbf{y})$ at infinity guarantees that the second integral vanishes, as long as ∂D is a finite hypersurface. To guarantee the disappearance of the first integral, we must demand that $G_D(\mathbf{x}, \mathbf{y})$ tend to zero faster than $f(\mathbf{y}) d^m y$ tends to infinity. For most cases of physical interest, the calculation of the exterior Green's functions is not conceptually different from that of the interior ones. However, the algebra may be more involved.

Later we will develop general methods for finding the Green's functions for certain partial differential operators that satisfy appropriate BCs. At this point, let us simply mention what are called mixed BCs for elliptic PDEs. A general mixed BC is of the form

$$\alpha(\mathbf{x})u(\mathbf{x}) + \beta(\mathbf{x})\frac{\partial u}{\partial n}(\mathbf{x}) = \gamma(\mathbf{x}). \tag{22.10}$$

Problem 22.6 examines the conditions that the GF must satisfy in such a case.

22.2 Parabolic Equations

Elliptic partial differential equations arise in static problems, where the solution is independent of time. Of the two major time-dependent equations, the wave equation and the heat (or diffusion) equation,² the latter is a parabolic PDE and the former a hyperbolic PDE. This section examines the heat equation, which is of the form $\nabla^2 u = a^2 \partial u / \partial t$. By changing t to t/a^2 , we can write the equation as $\mathbf{L}_{\mathbf{x},t}[u] \equiv (\partial/\partial t - \nabla^2)u(\mathbf{x}, t) = 0$. We wish to calculate the Green's function associated with $\mathbf{L}_{\mathbf{x},t}$ and the homogeneous BCs. Because of the time variable, we must also specify the solution at $t = 0$.

²The heat equation turns into the Schrödinger equation if t is changed to $\sqrt{-1}t$; thus, the following discussion incorporates the Schrödinger equation as well.

Thus, we consider the BVP

$$\mathbf{L}_{\mathbf{x},t}[u] \equiv \left(\frac{\partial}{\partial t} - \nabla^2 \right) u(\mathbf{x}, t) = 0 \quad \text{for } \mathbf{x} \in D, \quad (22.11)$$

$$u(\mathbf{x}_b, t) = 0, \quad u(\mathbf{x}, 0) = h(\mathbf{x}) \quad \text{for } \mathbf{x}_b \in \partial D, \mathbf{x} \in D.$$

To find a solution to (22.11), we can use a method that turns out to be useful for evaluating Green's functions in general—the method of eigenfunctions. Let $\{u_n\}_{n=1}^{\infty}$ be the eigenfunctions of ∇^2 with eigenvalues $\{-\lambda_n\}_{n=1}^{\infty}$. Let the BC be $u_n(\mathbf{x}_b) = 0$ for $\mathbf{x}_b \in \partial D$. Then

$$\begin{aligned} \nabla^2 u_n(\mathbf{x}) + \lambda_n u_n(\mathbf{x}) &= 0 \quad \text{for } n = 1, 2, \dots, \mathbf{x} \in D, \\ u_n(\mathbf{x}_b) &= 0 \quad \text{for } \mathbf{x}_b \in \partial D. \end{aligned} \quad (22.12)$$

Equation (22.12) constitutes a Sturm-Liouville problem in m dimensions, which we assume to have a solution with $\{u_n\}_{n=1}^{\infty}$ as a complete orthonormal set. We can therefore write

$$u(\mathbf{x}, t) = \sum_{n=1}^{\infty} C_n(t) u_n(\mathbf{x}). \quad (22.13)$$

This is possible because at each specific value of t , $u(\mathbf{x}, t)$ is a function of \mathbf{x} and therefore can be written as a linear combination of the *same set*, $\{u_n\}_{n=1}^{\infty}$. The coefficients $C_n(t)$ are given by

$$C_n(t) = \int_D u(\mathbf{x}, t) u_n(\mathbf{x}) d^m x. \quad (22.14)$$

To calculate $C_n(t)$, we differentiate (22.14) with respect to time and use (22.11) to obtain

$$\dot{C}_n(t) \equiv \frac{dC_n}{dt} = \int_D \frac{\partial u}{\partial t}(\mathbf{x}, t) u_n(\mathbf{x}) d^m x = \int_D [\nabla^2 u(\mathbf{x}, t)] u_n(\mathbf{x}) d^m x.$$

Using Green's identity for the operator ∇^2 yields

$$\int_D [u_n \nabla^2 u - u \nabla^2 u_n] d^m x = \int_{\partial D} \left(u_n \frac{\partial u}{\partial n} - u \frac{\partial u_n}{\partial n} \right) da.$$

Since both u and u_n vanish on ∂D , the RHS is zero, and we get

$$\dot{C}_n(t) = \int_D u \nabla^2 u_n d^m x = -\lambda_n \int_D u(\mathbf{x}, t) u_n(\mathbf{x}) d^m x = -\lambda_n C_n.$$

This has the solution $C_n(t) = C_n(0)e^{-\lambda_n t}$, where

$$C_n(0) = \int_D u(\mathbf{y}, 0) u_n(\mathbf{y}) d^m y = \int_D h(\mathbf{y}) u_n(\mathbf{y}) d^m y,$$

so that

$$C_n(t) = e^{-\lambda_n t} \int_D h(\mathbf{y}) u_n(\mathbf{y}) d^m y.$$

Substituting this in (22.13) and switching the order of integration and summation, we get

$$u(\mathbf{x}, t) = \int_D \left[\sum_{n=1}^{\infty} e^{-\lambda_n t} u_n(\mathbf{x}) u_n(\mathbf{y}) \right] h(\mathbf{y}) d^m y$$

and read off the GF as $\sum_{n=1}^{\infty} e^{-\lambda_n t} u_n(\mathbf{x}) u_n(\mathbf{y}) \theta(t)$, where we also introduced the theta function to ensure that the solution vanishes for $t < 0$. More generally, we have

$$G(\mathbf{x}, \mathbf{y}; t - \tau) = \sum_{n=1}^{\infty} e^{-\lambda_n(t-\tau)} u_n(\mathbf{x}) u_n(\mathbf{y}) \theta(t - \tau). \tag{22.15}$$

Note the property

$$\lim_{\tau \rightarrow t} G(\mathbf{x}, \mathbf{y}; t - \tau) = \sum_{n=1}^{\infty} u_n(\mathbf{x}) u_n(\mathbf{y}) = \delta(\mathbf{x} - \mathbf{y}),$$

which is usually written as

$$G(\mathbf{x}, \mathbf{y}; 0^+) = \delta(\mathbf{x} - \mathbf{y}). \tag{22.16}$$

The reader may also check that

$$\mathbf{L}_{\mathbf{x},t} G(\mathbf{x}, \mathbf{y}; t - \tau) = \delta(\mathbf{x} - \mathbf{y}) \delta(t - \tau). \tag{22.17}$$

This is precisely what we expect for the Green’s function of an operator in the variables \mathbf{x} and t . Another property of $G(\mathbf{x}, \mathbf{y}; t - \tau)$ is that it vanishes on ∂D , as it should.

Having found the Green’s function and noted its properties, we are in a position to solve the inhomogeneous analogue of Eq. (22.11), in which the RHS of the first equation is $f(\mathbf{x}, t)$, and the zero on the RHS of the second equation is replaced by $g(\mathbf{x}_b, t)$. Experience with similar but simpler problems indicates that to make any progress toward a solution, we must come up with a form of Green’s identity involving $\mathbf{L}_{\mathbf{x},t}$ and its adjoint. It is easy to show that

$$v \mathbf{L}_{\mathbf{x},t} [u] - u \mathbf{L}_{\mathbf{x},t}^\dagger [v] = \frac{\partial}{\partial t} (uv) - \nabla \cdot (v \nabla u - u \nabla v), \tag{22.18}$$

where $\mathbf{L}_{\mathbf{x},t}^\dagger = -\partial/\partial t - \nabla^2$.

Now consider the $(m + 1)$ -dimensional “cylinder” one of whose bases is at $t = \epsilon$, where ϵ is a small positive number. This base is barely above the m -dimensional hyperplane \mathbb{R}^m . The other base is at $t = \tau - \epsilon$ and is a duplicate of $D \subset \mathbb{R}^m$ (see Fig. 22.1). Let a^μ , where $\mu = 0, 1, \dots, m$, be the components of an $(m + 1)$ -dimensional vector $\mathbf{a} = (a^0, a^1, \dots, a^m)$. Define an inner product by

$$\mathbf{a} \cdot \mathbf{b} \equiv \sum_{\mu=0}^m a^\mu b_\mu \equiv a^0 b^0 - a^1 b^1 - \dots - a^m b^m \equiv a^0 b^0 - \mathbf{a} \cdot \mathbf{b}$$

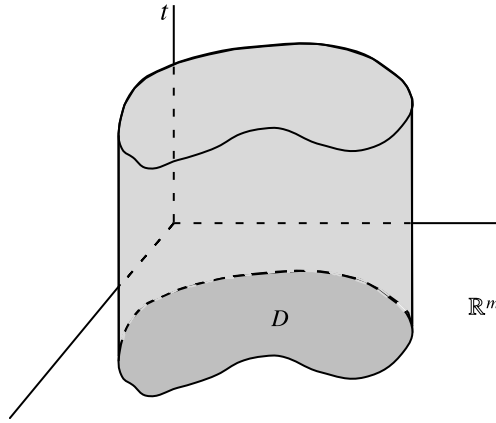

Fig. 22.1 The “cylinder” used in evaluating the GF for the diffusion and wave equations. Note that the bases are not planes, but hyperplanes (that is, spaces such as \mathbb{R}^m)

and the $(m + 1)$ -dimensional vector $\mathbf{Q} \equiv (Q^0, \mathbf{Q})$ by $Q^0 = uv$, $\mathbf{Q} = v\nabla u - u\nabla v$. Then (22.18) can be expressed as

$$v\mathbf{L}_{\mathbf{x},t}[u] - u\mathbf{L}_{\mathbf{x},t}^\dagger[v] = \sum_{\mu=0}^m \frac{\partial Q^\mu}{\partial x^\mu} \equiv \frac{\partial Q^0}{\partial x^0} - \frac{\partial Q^1}{\partial x^1} - \dots - \frac{\partial Q^m}{\partial x^m}. \quad (22.19)$$

We recognize the RHS as a divergence in $(m + 1)$ -dimensional space. Denoting the volume of the $(m + 1)$ -dimensional cylinder by \mathcal{D} and its boundary by $\partial\mathcal{D}$ and integrating (22.19) over \mathcal{D} , we obtain

$$\begin{aligned} \int_{\mathcal{D}} (v\mathbf{L}_{\mathbf{x},t}[u] - u\mathbf{L}_{\mathbf{x},t}^\dagger[v])d^{m+1}x &= \int_{\mathcal{D}} \sum_{\mu=0}^m \frac{\partial Q^\mu}{\partial x^\mu} d^{m+1}x \\ &= \int_{\partial\mathcal{D}} \sum_{\mu=0}^m Q^\mu n_\mu dS, \end{aligned} \quad (22.20)$$

where dS is an element of “area” of $\partial\mathcal{D}$. Note that the divergence theorem was used in the last step. The LHS is an integration over t and \mathbf{x} , which can be written as

$$\int_{\mathcal{D}} (v\mathbf{L}_{\mathbf{x},t}[u] - u\mathbf{L}_{\mathbf{x},t}^\dagger[v])d^{m+1}x = \int_\epsilon^{\tau-\epsilon} dt \int_D d^m x (v\mathbf{L}_{\mathbf{x},t}[u] - u\mathbf{L}_{\mathbf{x},t}^\dagger[v]).$$

The RHS of (22.20), on the other hand, can be split into three parts: a base at $t = \epsilon$, a base at $t = \tau - \epsilon$, and the lateral surface. The base at $t = \epsilon$ is simply the region D , whose outward-pointing normal is in the negative t direction. Thus, $n_0 = -1$, and $n_i = 0$ for $i = 1, 2, \dots, m$. The base at $t = \tau - \epsilon$ is also the region D ; however, its normal is in the positive t direction. Thus, $n_0 = 1$, and $n_i = 0$ for $i = 1, 2, \dots, m$. The element of “area” for these two bases is simply $d^m x$. The unit normal to the lateral surface has no time component and is simply the unit normal to the boundary of D . The element of “area” for the lateral surface is $dt da$, where da is an element of

“area” for ∂D . Putting everything together, we can write (22.20) as

$$\begin{aligned} & \int_{\epsilon}^{\tau-\epsilon} dt \int_D d^m x (v \mathbf{L}_{\mathbf{x},t}[u] - u \mathbf{L}_{\mathbf{x},t}^{\dagger}[v]) \\ &= \int_D (-Q^0)|_{t=\epsilon} d^m x + \int_D Q^0|_{t=\tau-\epsilon} d^m x - \int_{\partial D} da \int_{\epsilon}^{\tau-\epsilon} dt \mathbf{Q} \cdot \hat{\mathbf{e}}_n. \end{aligned}$$

The minus sign for the last term is due to the definition of the inner product. Substituting for \mathbf{Q} yields

$$\begin{aligned} & \int_{\epsilon}^{\tau-\epsilon} dt \int_D d^m x (v \mathbf{L}_{\mathbf{x},t}[u] - u \mathbf{L}_{\mathbf{x},t}^{\dagger}[v]) \\ &= - \int_D u(\mathbf{x}, \epsilon) v(\mathbf{x}, \epsilon) d^m x + \int_D u(\mathbf{x}, \tau - \epsilon) v(\mathbf{x}, \tau - \epsilon) d^m x \\ & \quad - \int_{\partial D} da \int_{\epsilon}^{\tau-\epsilon} dt \left(v \frac{\partial u}{\partial n} - u \frac{\partial v}{\partial n} \right). \end{aligned} \quad (22.21)$$

Let v be $g(\mathbf{x}, \mathbf{y}; t - \tau)$, the GF associated with the adjoint operator. Then Eq. (22.21) gives

$$\begin{aligned} & \int_{\epsilon}^{\tau-\epsilon} dt \int_D d^m x [g(\mathbf{x}, \mathbf{y}; t - \tau) f(\mathbf{x}, t) - u(\mathbf{x}, t) \delta(\mathbf{x} - \mathbf{y}) \delta(t - \tau)] \\ &= - \int_D u(\mathbf{x}, \epsilon) g(\mathbf{x}, \mathbf{y}; \epsilon - \tau) d^m x + \int_D u(\mathbf{x}, \tau - \epsilon) g(\mathbf{x}, \mathbf{y}; -\epsilon) d^m x \\ & \quad - \int_{\partial D} da \int_{\epsilon}^{\tau-\epsilon} dt \left[g(\mathbf{x}_b, \mathbf{y}; t - \tau) \frac{\partial u}{\partial n} - u(\mathbf{x}_b, t) \frac{\partial g}{\partial n} \right]. \end{aligned} \quad (22.22)$$

We now use the following facts:

1. $\delta(t - \tau) = 0$ in the second integral on the LHS of Eq. (22.22), because t can never be equal to τ in the range of integration.
2. Using the symmetry property of the Green’s function and the fact that $\mathbf{L}_{\mathbf{x},t}$ is real, we have $g(\mathbf{x}, \mathbf{y}; t - \tau) = G(\mathbf{y}, \mathbf{x}; \tau - t)$, where we have used the fact that t and τ are the time components of \mathbf{x} and \mathbf{y} , respectively. In particular, by (22.16), $g(\mathbf{x}, \mathbf{y}; -\epsilon) = G(\mathbf{y}, \mathbf{x}; \epsilon) = \delta(\mathbf{x} - \mathbf{y})$.
3. The function $g(\mathbf{x}, \mathbf{y}; t - \tau)$ satisfies the same homogeneous BC as $G(\mathbf{x}, \mathbf{y}; t - \tau)$. Thus, $g(\mathbf{x}_b, \mathbf{y}; t - \tau) = 0$ for $\mathbf{x}_b \in \partial D$.

Substituting all the above in (22.22), taking the limit $\epsilon \rightarrow 0$, and switching \mathbf{x} and \mathbf{y} and t and τ , we obtain

$$\begin{aligned} u(\mathbf{x}, t) &= \int_0^t d\tau \int_D d^m y G(\mathbf{x}, \mathbf{y}; t - \tau) f(\mathbf{y}, \tau) + \int_D u(\mathbf{y}, 0) G(\mathbf{x}, \mathbf{y}; t) d^m y \\ & \quad - \int_0^t d\tau \int_{\partial D} u(\mathbf{y}_b, \tau) \frac{\partial G}{\partial n_y}(\mathbf{x}, \mathbf{y}_b; t - \tau) da, \end{aligned} \quad (22.23)$$

where $\partial/\partial n_y$ in the last integral means *normal* differentiation with respect to the second argument of the Green’s function.

Equation (22.23) gives the complete solution to the BVP associated with a parabolic PDE. If $f(\mathbf{y}, \tau) = 0$ and u vanishes on the hypersurface ∂D , then Eq. (22.23) gives

$$u(\mathbf{x}, t) = \int_D u(\mathbf{y}, 0)G(\mathbf{x}, \mathbf{y}; t)d^m y, \quad (22.24)$$

GF as evolution operator
or propagator

which is the solution to the BVP of Eq. (22.11), which led to the general Green's function of (22.15). Equation (22.24) lends itself nicely to a physical interpretation. The RHS can be thought of as an integral operator with kernel $G(\mathbf{x}, \mathbf{y}; t)$. This integral operator acts on $u(\mathbf{y}, 0)$ and gives $u(\mathbf{x}, t)$; that is, given the shape of the solution at $t = 0$, the integral operator produces the shape for all subsequent time. That is why $G(\mathbf{x}, \mathbf{y}; t)$ is called the **evolution operator**, or **propagator**.

22.3 Hyperbolic Equations

The hyperbolic equation we will discuss is the wave equation

$$\mathbf{L}_{\mathbf{x},t}[u] \equiv \left(\frac{\partial^2}{\partial t^2} - \nabla^2 \right) u(\mathbf{x}, t) = 0, \quad (22.25)$$

where we have set the speed of the wave equal to unity.

We wish to calculate the Green's function for $\mathbf{L}_{\mathbf{x},t}$ subject to appropriate BCs. Let us proceed as we did for the parabolic equation and write

$$G(\mathbf{x}, \mathbf{y}; t) = \sum_{n=1}^{\infty} C_n(\mathbf{y}; t)u_n(\mathbf{x}) \quad (22.26)$$

$$C_n(\mathbf{y}; t) = \int_D G(\mathbf{x}, \mathbf{y}; t)u_n(\mathbf{x})d^m x,$$

where $u_n(\mathbf{x})$ are orthonormal eigenfunctions of ∇^2 with eigenvalues $-\lambda_n$, satisfying certain, as yet unspecified, BCs. As usual, we expect G to satisfy

$$\mathbf{L}_{\mathbf{x},t}[G] = \left(\frac{\partial^2}{\partial t^2} - \nabla^2 \right) G(\mathbf{x}, \mathbf{y}; t - \tau) = \delta(\mathbf{x} - \mathbf{y})\delta(t - \tau). \quad (22.27)$$

Substituting (22.26) in (22.27) with $\tau = 0$ and using $\nabla^2 u_n = -\lambda_n u_n$, gives

$$\sum_{n=1}^{\infty} \left\{ \frac{\partial^2}{\partial t^2} C_n(\mathbf{y}; t) + \lambda_n C_n(\mathbf{y}; t) \right\} u_n(\mathbf{x}) = \sum_{n=1}^{\infty} [u_n(\mathbf{y})\delta(t)]u_n(\mathbf{x}),$$

where we used $\delta(\mathbf{x} - \mathbf{y}) = \sum_{n=1}^{\infty} u_n(\mathbf{x})u_n(\mathbf{y})$ on the RHS. The orthonormality of u_n now gives $\ddot{C}_n(\mathbf{y}; t) + \lambda_n C_n(\mathbf{y}; t) = u_n(\mathbf{y})\delta(t)$. It follows that $C_n(\mathbf{y}; t)$ is separable. In fact,

$$C_n(\mathbf{y}; t) = u_n(\mathbf{y})T_n(t) \quad \text{where} \quad \left(\frac{d^2}{dt^2} + \lambda_n \right) T_n(t) = \delta(t).$$

This equation describes a one-dimensional Green's function and can be solved using the methods of Chap. 20. Assuming that $T_n(t) = 0$ for $t \leq 0$, we obtain $T_n(t) = (\sin \omega_n t / \omega_n) \theta(t)$, where $\omega_n^2 = \lambda_n$. Substituting all the above results in (22.26), we obtain

$$G(\mathbf{x}, \mathbf{y}; t) = \sum_{n=1}^{\infty} u_n(\mathbf{x}) u_n(\mathbf{y}) \frac{\sin \omega_n t}{\omega_n} \theta(t),$$

or, more generally,

$$G(\mathbf{x}, \mathbf{y}; t - \tau) = \sum_{n=1}^{\infty} u_n(\mathbf{x}) u_n(\mathbf{y}) \frac{\sin \omega_n(t - \tau)}{\omega_n} \theta(t - \tau). \quad (22.28)$$

We note that

$$G(\mathbf{x}, \mathbf{y}; 0^+) = 0 \quad \text{and} \quad \left. \frac{\partial G}{\partial t}(\mathbf{x}, \mathbf{y}; t) \right|_{t \rightarrow 0^+} = \delta(\mathbf{x} - \mathbf{y}), \quad (22.29)$$

as can easily be verified.

With the Green's function for the operator $\mathbf{L}_{\mathbf{x},t}$ of Eq. (22.25) at our disposal, we can attack the BVP given by

$$\begin{aligned} \left(\frac{\partial^2}{\partial t^2} - \nabla^2 \right) u(\mathbf{x}, t) &= f(\mathbf{x}, t) \quad \text{for } \mathbf{x} \in D, \\ u(\mathbf{x}_b, t) &= h(\mathbf{x}_b, t), \quad u(\mathbf{x}, 0) = \phi(\mathbf{x}) \quad \text{for } \mathbf{x}_b \in \partial D, \mathbf{x} \in D, \\ \left. \frac{\partial u}{\partial t}(\mathbf{x}, t) \right|_{t=0} &= \psi(\mathbf{x}) \quad \text{for } \mathbf{x} \in D. \end{aligned} \quad (22.30)$$

As in the case of the parabolic equation, we first derive an appropriate expression of Green's identity. This can be done by noting that

$$v \mathbf{L}_{\mathbf{x},t}[u] - u \mathbf{L}_{\mathbf{x},t}^\dagger[v] = \frac{\partial}{\partial t} \left(u \frac{\partial v}{\partial t} - v \frac{\partial u}{\partial t} \right) - \nabla \cdot (u \nabla v - v \nabla u).$$

Thus, $\mathbf{L}_{\mathbf{x},t}$ is formally self-adjoint. Furthermore, we can identify

$$Q^0 = u \frac{\partial v}{\partial t} - v \frac{\partial u}{\partial t} \quad \text{and} \quad \mathbf{Q} = u \nabla v - v \nabla u.$$

Following the procedure used for the parabolic case step by step, we can easily derive a Green's identity and show that

$$\begin{aligned} u(\mathbf{x}, t) &= \int_0^t d\tau \int_D d^m y G(\mathbf{x}, \mathbf{y}; t - \tau) f(\mathbf{y}, \tau) \\ &+ \int_D \left[\psi(\mathbf{y}) G(\mathbf{x}, \mathbf{y}; t) - \phi(\mathbf{y}) \frac{\partial G}{\partial t}(\mathbf{x}, \mathbf{y}; t) \right] d^m y \\ &- \int_0^t d\tau \int_{\partial D} h(\mathbf{y}_b, \tau) \frac{\partial G}{\partial n_y}(\mathbf{x}, \mathbf{y}_b; t - \tau) da. \end{aligned} \quad (22.31)$$

The details are left as Problem 22.11.

For the homogeneous PDE with the homogeneous BC $h = 0 = \psi$, we get

$$u(\mathbf{x}, t) = - \int_D \phi(\mathbf{y}) \frac{\partial G}{\partial t}(\mathbf{x}, \mathbf{y}; t) d^m y.$$

Note the difference between this equation and Eq. (22.24). Here the propagator is the time derivative of the Green's function. There is another difference between hyperbolic and parabolic equations. When the solution to a parabolic equation vanishes on the boundary and is initially zero, and the PDE is homogeneous [$f(\mathbf{x}, t) = 0$], the solution must be zero. This is clear from Eq. (22.23). On the other hand, Eq. (22.31) indicates that under the same circumstance, there may be a nonzero solution for a hyperbolic equation if ψ is nonzero. In such a case we obtain

$$u(\mathbf{x}, t) = \int_D \psi(\mathbf{y}) G(\mathbf{x}, \mathbf{y}; t) d^m y.$$

This difference in the two types of equations is due to the fact that hyperbolic equations have second-order time derivatives. Thus, the initial shape of a solution is not enough to uniquely specify it. The initial velocity profile is also essential. We saw examples of this in Chap. 19.

The discussion of Green's functions has so far been formal. The main purpose of the remaining sections is to bridge the gap between formalism and concrete applications. Several powerful techniques are used in obtaining Green's functions, but we will focus only on two: the Fourier transform technique, and the eigenfunction expansion technique.

22.4 The Fourier Transform Technique

Recall that any Green's function can be written as a sum of a singular part and a regular part: $G = G_s + H$. Since we have already discussed homogeneous equations in detail in Chap. 19, we will not evaluate H in this section but will concentrate on the singular parts of various Green's functions.

The BCs play no role in evaluating G_s . Therefore, the Fourier transform technique (FTT), which involves integration over all space, can be utilized. The FTT has a drawback—it does not work if the coefficient functions are not constants. For most physical applications treated in this book, however, this will not be a shortcoming.

Let us consider the most general SOLPDO with constant coefficients,

$$\mathbf{L}_x = a_0 + \sum_{j=1}^m a_j \frac{\partial}{\partial x_j} + \sum_{j,k=1}^m b_{jk} \frac{\partial^2}{\partial x_j \partial x_k}, \quad (22.32)$$

where a_0 , a_j , and b_{jk} are constants. The corresponding Green's function has a singular part that satisfies the usual PDE with the delta function on the RHS. The FTT starts with assuming a Fourier integral representation in the variable \mathbf{x} for the singular part and for the delta function:

$$G_s(\mathbf{x}, \mathbf{y}) = \frac{1}{(2\pi)^{m/2}} \int d^m k \tilde{G}_s(\mathbf{k}, \mathbf{y}) e^{i\mathbf{k}\cdot\mathbf{x}},$$

$$\delta(\mathbf{x} - \mathbf{y}) = \frac{1}{(2\pi)^m} \int d^m k e^{i\mathbf{k} \cdot (\mathbf{x} - \mathbf{y})}.$$

Substituting these equations in the PDE for the GF, we get

$$\tilde{G}_s(\mathbf{k}, \mathbf{y}) = \frac{1}{(2\pi)^{m/2}} \left(\frac{e^{-i\mathbf{k} \cdot \mathbf{y}}}{a_0 + i \sum_{j=1}^m a_j k_j - \sum_{j,l=1}^m b_{jl} k_j k_l} \right)$$

and

$$G_s(\mathbf{x}, \mathbf{y}) = \frac{1}{(2\pi)^m} \int d^m k \frac{e^{i\mathbf{k} \cdot (\mathbf{x} - \mathbf{y})}}{a_0 + i \sum_{j=1}^m a_j k_j - \sum_{j,l=1}^m b_{jl} k_j k_l}. \quad (22.33)$$

If we can evaluate the integral in (22.33), we can find G .

The following examples apply Eq. (22.33) to specific problems. Note that (22.33) indicates that G_s depends only on $\mathbf{x} - \mathbf{y}$. This point was mentioned in Chap. 20, where it was noted that such dependence occurs when the BCs play no part in an evaluation of the singular part of the Green's function of a DE with constant coefficients; and this is exactly the situation here.

22.4.1 GF for the m -Dimensional Laplacian

We calculated the GF for the m -dimensional Laplacian in Sect. 21.2.2 using a different method. With $a_0 = 0 = a_j$, $b_{jl} = \delta_{jl}$, and $\mathbf{r} = \mathbf{x} - \mathbf{y}$, Eq. (22.33) reduces to

$$G_s(\mathbf{r}) = \frac{1}{(2\pi)^m} \int d^m k \frac{e^{i\mathbf{k} \cdot \mathbf{r}}}{-k^2}, \quad (22.34)$$

where $k^2 = k_1^2 + \dots + k_m^2 = \mathbf{k} \cdot \mathbf{k}$. To integrate (22.34), we choose spherical coordinates in the m -dimensional k -space. Furthermore, to simplify calculations we let the k_m -axis lie along \mathbf{r} so that $\mathbf{r} = (0, 0, \dots, |\mathbf{r}|)$ and $\mathbf{k} \cdot \mathbf{r} = k|\mathbf{r}| \cos \theta_1$ [see Eq. (21.12)]. Substituting this in (22.34) and writing $d^m k$ in spherical coordinates yields

$$G_s(\mathbf{r}) = \frac{-1}{(2\pi)^m} \int \frac{e^{ik|\mathbf{r}|\cos\theta_1}}{k^2} \times k^{m-1} (\sin\theta_1)^{m-2} \dots \sin\theta_{m-2} dk d\theta_1 \dots d\theta_{m-1}. \quad (22.35)$$

From Eq. (21.15) we note that $d\Omega_m = (\sin\theta_1)^{m-2} d\theta_1 d\Omega_{m-1}$. Thus, after integrating over the angles $\theta_2, \dots, \theta_{m-1}$, Eq. (22.35) becomes

$$G_s(\mathbf{r}) = -\frac{1}{(2\pi)^m} \Omega_{m-1} \int_0^\infty k^{m-3} dk \int_0^\pi (\sin\theta_1)^{m-2} e^{ik|\mathbf{r}|\cos\theta_1} d\theta_1.$$

The inner integral can be looked up in an integral table (see [Grad 65, p. 482]):

$$\int_0^\pi (\sin\theta_1)^{m-2} e^{ik|\mathbf{r}|\cos\theta_1} d\theta_1 = \sqrt{\pi} \left(\frac{2}{kr} \right)^{m/2-1} \Gamma\left(\frac{m-1}{2} \right) J_{m/2-1}(kr).$$

Substituting this and (21.16) in the preceding equation and using the result (see [Grad 65, p. 684])

$$\int_0^\infty x^\mu J_\nu(ax) dx = 2^\mu a^{-\mu-1} \frac{\Gamma(\frac{\mu+\nu+1}{2})}{\Gamma(\frac{\mu-\nu+1}{2})},$$

we obtain

$$G_s(\mathbf{r}) = -\frac{\Gamma(m/2-1)}{4\pi^{m/2}} \left(\frac{1}{r^{m-2}} \right) \quad \text{for } m > 2,$$

which agrees with (21.20) since $\Gamma(m/2) = (m/2-1)\Gamma(m/2-1)$.

22.4.2 GF for the m -Dimensional Helmholtz Operator

For the Helmholtz operator $\nabla^2 - \mu^2$, Eq. (22.33) reduces to

$$G_s(\mathbf{r}) = -\frac{1}{(2\pi)^m} \int d^m k \frac{e^{i\mathbf{k}\cdot\mathbf{r}}}{\mu^2 + k^2}.$$

Following the same procedure as in the previous subsection, we find

$$\begin{aligned} G_s(\mathbf{r}) &= -\frac{\Omega_{m-1}}{(2\pi)^m} \int_0^\infty \frac{k^{m-1} dk}{\mu^2 + k^2} \int_0^\pi (\sin\theta_1)^{m-2} e^{ikr \cos\theta_1} d\theta_1 \\ &= -\frac{\Omega_{m-1}}{(2\pi)^m} \sqrt{\pi} \left(\frac{2}{r} \right)^{m/2-1} \Gamma\left(\frac{m-1}{2}\right) \int_0^\infty \frac{k^{m/2}}{\mu^2 + k^2} J_{m/2-1}(kr) dk. \end{aligned}$$

Here we can use the integral formula (see [Grad 65, pp. 686 and 952])

$$\int_0^\infty \frac{J_\nu(bx)x^{\nu+1}}{(x^2+a^2)^{\eta+1}} dx = \frac{a^{\nu-\eta} b^\eta}{2^\eta \Gamma(\eta+1)} K_{\nu-\eta}(ab),$$

where

$$K_\nu(z) = \frac{i\pi}{2} e^{i\nu\pi/2} H_\nu^{(1)}(iz),$$

to obtain

$$G_s(\mathbf{r}) = -\frac{\Omega_{m-1}}{(2\pi)^m} \sqrt{\pi} \left(\frac{2}{r} \right)^{m/2-1} \Gamma\left(\frac{m-1}{2}\right) \mu^{m/2-1} \frac{\pi}{2} e^{im\pi/4} H_{m/2-1}^{(1)}(i\mu r),$$

which simplifies to

$$G_s(\mathbf{r}) = -\frac{\pi/2}{(2\pi)^{m/2}} \left(\frac{\mu}{r} \right)^{m/2-1} e^{im\pi/4} H_{m/2-1}^{(1)}(i\mu r). \quad (22.36)$$

It can be shown (see Problem 22.8) that for $m = 3$ this reduces to $G_s(\mathbf{r}) = -\frac{e^{-\mu r}}{4\pi r}$, which is the Yukawa potential due to a unit charge.

We can easily obtain the GF for $\nabla^2 + \mu^2$ by substituting $\pm i\mu$ for μ in Eq. (22.36). The result is

$$G_s(\mathbf{r}) = i^{m+1} \frac{\pi/2}{(2\pi)^{m/2}} \left(\frac{\mu}{r}\right)^{m/2-1} H_{m/2-1}^{(1)}(\pm\mu r). \quad (22.37)$$

For $m = 3$ this yields $G_s(\mathbf{r}) = -e^{\pm i\mu r}/(4\pi r)$. The two signs in the exponent correspond to the so-called incoming and outgoing “waves”.

Example 22.4.1 For a non-local potential, the time-independent Schrödinger equation is

$$-\frac{\hbar^2}{2\mu} \nabla^2 \Psi + \int_{\mathbb{R}^3} V(\mathbf{r}, \mathbf{r}') \Psi(\mathbf{r}') d^3 r' = E \Psi(\mathbf{r}).$$

Then, the integral equation associated with this differential equation is (see Sect. 21.4)

$$\Psi(\mathbf{r}) = A e^{i\mathbf{k}\cdot\mathbf{r}} - \frac{\mu}{2\pi\hbar^2} \int_{\mathbb{R}^3} d^3 r' \frac{e^{ik|\mathbf{r}-\mathbf{r}'|}}{|\mathbf{r}-\mathbf{r}'|} \int_{\mathbb{R}^3} d^3 r'' V(\mathbf{r}', \mathbf{r}'') \Psi(\mathbf{r}''). \quad (22.38)$$

For a separable potential, for which $V(\mathbf{r}', \mathbf{r}'') = -g^2 U(\mathbf{r}') U(\mathbf{r}'')$, we can solve (22.38) exactly. We substitute for $V(\mathbf{r}', \mathbf{r}'')$ in (22.38) to obtain

$$\Psi(\mathbf{r}) = A e^{i\mathbf{k}\cdot\mathbf{r}} + \frac{\mu g^2}{2\pi\hbar^2} \int_{\mathbb{R}^3} d^3 r' \frac{e^{ik|\mathbf{r}-\mathbf{r}'|}}{|\mathbf{r}-\mathbf{r}'|} U(\mathbf{r}') \int_{\mathbb{R}^3} d^3 r'' U(\mathbf{r}'') \Psi(\mathbf{r}''). \quad (22.39)$$

Defining the quantities

$$Q(\mathbf{r}) \equiv \frac{\mu g^2}{2\pi\hbar^2} \int_{\mathbb{R}^3} d^3 r' \frac{e^{ik|\mathbf{r}-\mathbf{r}'|}}{|\mathbf{r}-\mathbf{r}'|} U(\mathbf{r}'), \quad C \equiv \int_{\mathbb{R}^3} d^3 r'' U(\mathbf{r}'') \Psi(\mathbf{r}'') \quad (22.40)$$

and substituting them in (22.39) yields $\Psi(\mathbf{r}) = A e^{i\mathbf{k}\cdot\mathbf{r}} + C Q(\mathbf{r})$. Multiplying both sides of this equation by $U(\mathbf{r})$ and integrating over \mathbb{R}^3 , we get

$$\begin{aligned} C &= A \int_{\mathbb{R}^3} e^{i\mathbf{k}\cdot\mathbf{r}} U(\mathbf{r}) d^3 r + C \int_{\mathbb{R}^3} U(\mathbf{r}) Q(\mathbf{r}) d^3 r \\ &= (2\pi)^{3/2} A \tilde{U}(-\mathbf{k}) + C \int_{\mathbb{R}^3} U(\mathbf{r}) Q(\mathbf{r}) d^3 r, \end{aligned}$$

from which we obtain

$$C = \frac{(2\pi)^{3/2} A \tilde{U}(-\mathbf{k})}{1 - \int_{\mathbb{R}^3} U(\mathbf{r}) Q(\mathbf{r}) d^3 r},$$

leading to the solution

$$\Psi(\mathbf{r}) = A e^{i\mathbf{k}\cdot\mathbf{r}} + \frac{(2\pi)^{3/2} A \tilde{U}(-\mathbf{k})}{1 - \int_{\mathbb{R}^3} U(\mathbf{r}') Q(\mathbf{r}') d^3 r'} Q(\mathbf{r}). \quad (22.41)$$

In principle, $\tilde{U}(-\mathbf{k})$ [the Fourier transform of $U(\mathbf{r})$] and $Q(\mathbf{r})$ can be calculated once the functional form of $U(\mathbf{r})$ is known. Equations (22.40) and (22.41) give the solution to the Schrödinger equation in closed form.

Non-local potentials depend not only on the observation point, but also on some other “non-local” variables.

22.4.3 GF for the m -Dimensional Diffusion Operator

When dealing with parabolic and hyperbolic equations, we will find it convenient to consider the “different” variable (usually t) as the zeroth coordinate. In the Fourier transform we then use $\omega = -k_0$ and write

$$G_s(\mathbf{r}, t) = \frac{1}{(2\pi)^{(m+1)/2}} \int_{-\infty}^{\infty} d\omega \int d^m k \tilde{G}_s(\mathbf{k}, \omega) e^{i(\mathbf{k}\cdot\mathbf{r}-\omega t)}, \quad (22.42)$$

$$\delta(\mathbf{r})\delta(t) = \frac{1}{(2\pi)^{m+1}} \int_{-\infty}^{\infty} d\omega \int d^m k e^{i(\mathbf{k}\cdot\mathbf{r}-\omega t)},$$

where \mathbf{r} is the m -dimensional position vector.

We substitute (22.42) in $(\partial/\partial t - \nabla^2)G_s(\mathbf{r}, t) = \delta(\mathbf{r})\delta(t)$ to obtain

$$G_s(\mathbf{r}, t) = \frac{1}{(2\pi)^{m+1}} \int d^m k e^{i\mathbf{k}\cdot\mathbf{r}} \int_{-\infty}^{\infty} d\omega \frac{e^{-i\omega t}}{\omega + ik^2}, \quad (22.43)$$

where as usual, $k^2 = \sum_{i=1}^m k_i^2$. The ω integration can be done using the calculus of residues. The integrand has a simple pole at $\omega = -ik^2$, that is, in the lower half of the complex ω -plane (LHP). To integrate, we must know the sign of t . If $t > 0$, the exponential factor dictates that the contour be closed in the LHP, where there is a pole and, therefore, a contribution to the residues. On the other hand, if $t < 0$, the contour must be closed in the UHP. The integral is then zero because there are no poles in the UHP. We must therefore introduce a step function $\theta(t)$ in the Green's function. Evaluating the residue, the ω integration yields $-2\pi i e^{-k^2 t}$. (The minus sign arises because of clockwise contour integration in the LHP.) Substituting this in Eq. (22.43), using spherical coordinates in which the last k -axis is along \mathbf{r} , and integrating over all angles except θ_1 , we obtain

$$G_s(\mathbf{r}, t) = \theta(t) \frac{\Omega_{m-1}}{(2\pi)^m} \int_0^\infty k^{m-1} dk e^{-k^2 t} \int_0^\pi (\sin \theta_1)^{m-2} e^{ikr \cos \theta_1} d\theta_1$$

$$= \theta(t) \frac{\Omega_{m-1}}{(2\pi)^m} \sqrt{\pi} \left(\frac{2}{r}\right)^{m/2-1} \Gamma\left(\frac{m-1}{2}\right)$$

$$\times \int_0^\infty k^{m/2} e^{-k^2 t} J_{m/2-1}(kr) dk.$$

For the θ_1 integration, we used the result quoted in Sect. 22.4.1.

Using the integral formula (see [Grad 65, pp. 716 and 1058])

$$\int_0^\infty x^\mu e^{-\alpha x^2} J_\nu(\beta x) dx$$

$$= \frac{\beta^\nu \Gamma(\frac{\mu+\nu+1}{2})}{2^{\nu+1} \alpha^{(\mu+\nu+1)/2} \Gamma(\nu+1)} \Phi\left(\frac{\mu+\nu+1}{2}, \nu+1; -\frac{\beta^2}{4\alpha}\right),$$

where Φ is the confluent hypergeometric function, we obtain

$$G_s(\mathbf{r}, t) = \theta(t) \frac{2\pi^{(m-1)/2}}{(2\pi)^m} \sqrt{\pi} \left(\frac{2}{r}\right)^{m/2-1} \frac{r^{m/2-1}}{2^{m/2} t^{m/2}} \Phi\left(\frac{m}{2}, \frac{m}{2}; -\frac{r^2}{4t}\right). \quad (22.44)$$

The power-series expansion for the confluent hypergeometric function Φ shows that $\Phi(\alpha, \alpha; z) = e^z$. Substituting this result in (22.44) and simplifying, we finally obtain

$$G_s(\mathbf{r}, t) = \frac{e^{-r^2/4t}}{(4\pi t)^{m/2}} \theta(t). \tag{22.45}$$

22.4.4 GF for the m -Dimensional Wave Equation

The difference between this example and the preceding one is that here the time derivative is of second order. Thus, instead of Eq. (22.43), we start with

$$G_s(\mathbf{r}, t) = -\frac{1}{(2\pi)^{m+1}} \int d^m k e^{i\mathbf{k}\cdot\mathbf{r}} \int_{-\infty}^{\infty} d\omega \frac{e^{-i\omega t}}{\omega^2 - k^2}. \tag{22.46}$$

The ω integration can be done using the method of residues. Since the singularities of the integrand, $\omega = \pm k$, are on the real axis, it seems reasonable to use the principal value as the value of the integral. This, in turn, depends on the sign of t . If $t > 0$ ($t < 0$), we have to close the contour in the LHP (UHP): to avoid the explosion of the exponential. If one also insists on not including the poles inside the contour,³ then one can show that

$$P \int_{-\infty}^{\infty} d\omega \frac{e^{-i\omega t}}{\omega^2 - k^2} = -\pi \frac{\sin kt}{k} \epsilon(t),$$

where

$$\epsilon(t) \equiv \theta(t) - \theta(-t) = \begin{cases} 1 & \text{if } t > 0, \\ -1 & \text{if } t < 0. \end{cases}$$

Substituting this in (22.46) and integrating over all angles as done in the previous examples yields

$$G_s(\mathbf{r}, t) = \frac{\epsilon(t)}{2(2\pi)^{m/2} r^{m/2-1}} \int_0^{\infty} k^{m/2-1} J_{m/2-1}(kr) \sin kt \, dk. \tag{22.47}$$

As Problem 22.25 shows, the Green's function given by Eq. (22.47) satisfies only the homogeneous wave equation with no delta function on the RHS. The reason for this is that the principal value of an integral chooses a specific contour that may not reflect the physical situation. In fact, the Green's function in (22.47) contains two pieces corresponding to the two different contours of integration, and it turns out that the physically interesting Green's functions are obtained, not from the principal value, but from giving small imaginary parts to the poles. Thus, replacing the ω integral with a contour integral for which the two poles are pushed in the LHP and using

Physics determines the contour of integration

³This will determine how to (semi)circle around the poles.

the method of residues, we obtain

$$I_{up} \equiv \int_{-\infty}^{\infty} d\omega \frac{e^{-i\omega t}}{\omega^2 - k^2} = \int_{C_1} \frac{e^{-izt}}{z^2 - k^2} dz = \frac{2\pi}{k} \theta(t) \sin kt.$$

The integral is zero for $t < 0$ because for negative values of t , the contour must be closed in the UHP, where there are no poles inside C_1 . Substituting this in (22.46) and working through as before, we obtain what is called the

retarded Green's function

$$G_s^{(\text{ret})}(\mathbf{r}, t) = \frac{\theta(t)}{(2\pi)^{m/2} r^{m/2-1}} \int_0^\infty k^{m/2-1} J_{m/2-1}(kr) \sin kt \, dk. \quad (22.48)$$

advanced Green's function

If the poles are pushed in the UHP we obtain the **advanced Green's function**:

$$G_s^{(\text{adv})}(\mathbf{r}, t) = -\frac{\theta(-t)}{(2\pi)^{m/2} r^{m/2-1}} \int_0^\infty k^{m/2-1} J_{m/2-1}(kr) \sin kt \, dk. \quad (22.49)$$

Unlike the elliptic and parabolic equations discussed earlier, the integral over k is not a function but a *distribution*, as will become clear below. To find the retarded and advanced Green's functions, we write the sine term in the integral in terms of exponentials and use the following (see [Grad 65, p. 712]):

$$\int_0^\infty x^\nu e^{-\alpha x} J_\nu(\beta x) \, dx = \frac{(2\beta)^\nu \Gamma(\nu + 1/2)}{\sqrt{\pi}(\alpha^2 + \beta^2)^{\nu+1/2}} \quad \text{for } \text{Re}(\alpha) > |\text{Im}(\beta)|.$$

To ensure convergence at infinity, we add a small negative number to the exponential and define the integral

$$\begin{aligned} I_\epsilon^\pm &\equiv \int_0^\infty k^\nu e^{-(\mp it + \epsilon)k} J_\nu(kr) \, dk \\ &= \frac{(2r)^\nu \Gamma(\nu + 1/2)}{\sqrt{\pi}} [(\mp it + \epsilon)^2 + r^2]^{-(\nu+1/2)}. \end{aligned}$$

For the GFs, we need to evaluate the (common) integral in (22.48) and (22.49). With $\nu = m/2 - 1$, we have

$$\begin{aligned} I^{(\nu)} &\equiv \int_0^\infty k^\nu J_\nu(kr) \sin kt \, dk = \frac{1}{2i} \lim_{\epsilon \rightarrow 0} (I_\epsilon^+ - I_\epsilon^-) \\ &= \frac{(2r)^\nu \Gamma(\nu + 1/2)}{2i \sqrt{\pi}} \\ &\quad \times \lim_{\epsilon \rightarrow 0} \left\{ \frac{1}{[r^2 + (-it + \epsilon)^2]^{\nu+1/2}} - \frac{1}{[r^2 + (it + \epsilon)^2]^{\nu+1/2}} \right\}. \end{aligned}$$

At this point, it is convenient to discuss separately the two cases of m odd and m even. Let us derive the expression for odd m (the even case is left for Problem 22.26). Define the integer $n = (m - 1)/2 = \nu + \frac{1}{2}$ and write $I^{(\nu)}$ as

$$I^{(n)} = \frac{(2r)^{n-1/2} \Gamma(n)}{2i \sqrt{\pi}} \lim_{\epsilon \rightarrow 0} \left\{ \frac{1}{[r^2 + (-it + \epsilon)^2]^n} - \frac{1}{[r^2 + (it + \epsilon)^2]^n} \right\}. \quad (22.50)$$

Define $u = r^2 + (-it + \epsilon)^2$. Then using the identity

$$\frac{1}{u^n} = \frac{(-1)^{n-1}}{(n-1)!} \frac{d^{n-1}}{du^{n-1}} \left(\frac{1}{u} \right)$$

and the chain rule, $df/du = (1/2r)\partial f/\partial r$, we obtain $d/du = (1/2r)\partial/\partial r$ and

$$\frac{1}{[r^2 + (\pm it + \epsilon)^2]^n} = \frac{1}{(n-1)!} \left(-\frac{1}{2r} \frac{\partial}{\partial r} \right)^{n-1} \left[\frac{1}{r^2 + (\pm it + \epsilon)^2} \right].$$

Therefore, Eq. (22.50) can be written as

$$\begin{aligned} I^{(n)} &= \int_0^\infty k^{n-1/2} J_{n-1/2}(kr) \sin kt \, dk \\ &= \frac{(2r)^{n-1/2} \Gamma(n)}{2i\sqrt{\pi}} \frac{1}{(n-1)!} \\ &\quad \times \left(-\frac{1}{2r} \frac{\partial}{\partial r} \right)^{n-1} \left\{ \lim_{\epsilon \rightarrow 0} \left[\frac{1}{[r^2 + (-it + \epsilon)^2]} - \frac{1}{[r^2 + (it + \epsilon)^2]} \right] \right\}. \end{aligned} \quad (22.51)$$

The limit in (22.51) is found in Problem 22.27. Using the result of that problem and $\Gamma(n) = (n-1)!$, we get

$$\begin{aligned} I^{(n)} &= \int_0^\infty k^{n-1/2} J_{n-1/2}(kr) \sin kt \, dk \\ &= -\frac{\sqrt{\pi}(2r)^{n-1/2}}{2} \left(-\frac{1}{2r} \frac{\partial}{\partial r} \right)^{n-1} \left\{ \frac{1}{r} [\delta(t+r) - \delta(t-r)] \right\}. \end{aligned} \quad (22.52)$$

Employing this result in (22.48) and (22.49) yields

$$\begin{aligned} G_s^{(\text{ret})}(\mathbf{r}, t) &= \frac{1}{4\pi} \left(-\frac{1}{2\pi r} \frac{\partial}{\partial r} \right)^{n-1} \left[\frac{\delta(t-r)}{r} \right] \quad \text{for } n = \frac{m-1}{2}, \\ G_s^{(\text{adv})}(\mathbf{r}, t) &= \frac{1}{4\pi} \left(-\frac{1}{2\pi r} \frac{\partial}{\partial r} \right)^{n-1} \left[\frac{\delta(t+r)}{r} \right] \quad \text{for } n = \frac{m-1}{2}. \end{aligned} \quad (22.53)$$

The theta functions are not needed in (22.53) because the arguments of the delta functions already meet the restrictions imposed by the theta functions.

The two functions in (22.53) have an interesting physical interpretation. Green's functions are propagators (of signals of some sort), and $G_s^{(\text{ret})}(\mathbf{r}, t)$ is capable of propagating signals only for positive times. On the other hand, $G_s^{(\text{adv})}(\mathbf{r}, t)$ can propagate only in the negative time direction. Thus, if initially ($t = 0$) a signal is produced (by appropriate BCs), both $G_s^{(\text{ret})}(\mathbf{r}, t)$ and $G_s^{(\text{adv})}(\mathbf{r}, t)$ work to propagate it in their respective time directions. It may seem that $G_s^{(\text{adv})}(\mathbf{r}, t)$ is useless because every signal propagates forward in time. This is true, however, only for classical events. In relativistic quantum field theory antiparticles are interpreted mathematically as moving in the negative time direction! Thus, we cannot simply ignore $G_s^{(\text{adv})}(\mathbf{r}, t)$.

In fact, the correct propagator to choose in this theory is a linear combination of $G_s^{(\text{adv})}(\mathbf{r}, t)$ and $G_s^{(\text{ret})}(\mathbf{r}, t)$, called the **Feynman propagator** (see [Wein 95, pp. 274–280]).

Feynman propagator

The preceding example shows a subtle difference between Green's functions for second-order differential operators in one dimension and in higher dimensions. We saw in Chap. 20 that the former are continuous functions in the interval on which they are defined. Here, we see that higher dimensional Green's functions are not only discontinuous, but that they are not even *functions* in the ordinary sense; they contain a delta function. Thus, in general, Green's functions in higher dimensions ought to be treated as distributions (generalized functions).

22.5 The Eigenfunction Expansion Technique

Suppose that the differential operator \mathbf{L}_x , defined in a domain D with boundary ∂D , has discrete eigenvalues $\{\lambda_n\}_{n=1}^{\infty}$ with corresponding orthonormal eigenfunctions $\{u_n(\mathbf{x})\}_{n=1}^{\infty}$. These two sets may not be in one-to-one correspondence. Assume that the $u_n(\mathbf{x})$'s satisfy the same BCs as the Green's function to be defined below.

Now consider the operator $\mathbf{L}_x - \lambda \mathbf{1}$, where λ is different from all λ_n 's. Then, as in the one-dimensional case, this operator is invertible, and we can define its Green's function by $(\mathbf{L}_x - \lambda)G_\lambda(\mathbf{x}, \mathbf{y}) = \delta(\mathbf{x} - \mathbf{y})$ where the weight function is set equal to one. The completeness of $\{u_n(\mathbf{x})\}_{n=1}^{\infty}$ implies that

$$\delta(\mathbf{x} - \mathbf{y}) = \sum_{n=1}^{\infty} u_n(\mathbf{x})u_n^*(\mathbf{y}) \quad \text{and} \quad G_\lambda(\mathbf{x}, \mathbf{y}) = \sum_{n=1}^{\infty} a_n(\mathbf{y})u_n(\mathbf{x}).$$

Substituting these two expansions in the differential equation for GF yields

$$\sum_{n=1}^{\infty} (\lambda_n - \lambda)a_n(\mathbf{y})u_n(\mathbf{x}) = \sum_{n=1}^{\infty} u_n(\mathbf{x})u_n^*(\mathbf{y}).$$

The orthonormality of the u_n 's gives $a_n(\mathbf{y}) = u_n^*(\mathbf{y})/(\lambda_n - \lambda)$. Therefore,

$$G_\lambda(\mathbf{x}, \mathbf{y}) = \sum_{n=1}^{\infty} \frac{u_n(\mathbf{x})u_n^*(\mathbf{y})}{\lambda_n - \lambda}. \quad (22.54)$$

In particular, if zero is not an eigenvalue of \mathbf{L}_x , its Green's function can be written as

$$G(\mathbf{x}, \mathbf{y}) = \sum_{n=1}^{\infty} \frac{u_n(\mathbf{x})u_n^*(\mathbf{y})}{\lambda_n}. \quad (22.55)$$

This is an expansion of the Green's function in terms of the eigenfunctions of \mathbf{L}_x .

It is instructive to consider a formal interpretation of Eq. (22.55). Recall that the spectral decomposition theorem permits us to write $f(\mathbf{A}) = \sum_i f(\lambda_i)\mathbf{P}_i$ for an operator \mathbf{A} with (distinct) eigenvalues λ_i and projection operators \mathbf{P}_i . Allowing repetition of eigenvalues in the sum, we may

write $f(\mathbf{A}) = \sum_n f(\lambda_n) |u_n\rangle \langle u_n|$, where n counts *all* the eigenfunctions corresponding to eigenvalues. Now, let $f(\mathbf{A}) = \mathbf{A}^{-1}$. Then

$$\mathbf{G} = \mathbf{A}^{-1} = \sum_n \lambda_n^{-1} |u_n\rangle \langle u_n| = \sum_n \frac{|u_n\rangle \langle u_n|}{\lambda_n},$$

or, in “matrix element” form,

$$G(\mathbf{x}, \mathbf{y}) = \langle \mathbf{x} | \mathbf{G} | \mathbf{y} \rangle = \sum_n \frac{\langle \mathbf{x} | u_n \rangle \langle u_n | \mathbf{y} \rangle}{\lambda_n} = \sum_n \frac{u_n(\mathbf{x}) u_n^*(\mathbf{y})}{\lambda_n}.$$

This last expression coincides with the RHS of Eq. (22.55).

Equations (22.54) and (22.55) demand that the $u_n(\mathbf{x})$ form a complete discrete orthonormal set. We encountered many examples of such eigenfunctions in discussing Sturm-Liouville systems in Chap. 19. All the S-L systems there were, of course, one-dimensional. Here we are generalizing the S-L system to m dimensions. This is not a limitation, however, because—for the PDEs of interest—the separation of variables reduces an m -dimensional PDE to m one-dimensional ODEs. If the BCs are appropriate, the m ODEs will all be S-L systems. A review of Chap. 19 will reveal that homogeneous BCs always lead to S-L systems. In fact, Theorem 19.4.1 guarantees this claim. Since Green’s functions must also satisfy homogeneous BCs, expansions such as those of (22.54) and (22.55) become possible.

Example 22.5.1 As a concrete example, let us obtain an eigenfunction expansion of the GF of the two-dimensional Laplacian, $\nabla^2 = \partial^2/\partial x^2 + \partial^2/\partial y^2$, inside the rectangular region $0 \leq x \leq a$, $0 \leq y \leq b$ with Dirichlet BCs. Since the GF vanishes at the boundary, the eigenvalue problem becomes $\nabla^2 u = \lambda u$ with $u(0, y) = u(a, y) = u(x, 0) = u(x, b) = 0$. The method of separation of variables gives the orthonormal eigenfunctions⁴

$$u_{mn}(x, y) = \frac{2}{\sqrt{ab}} \sin\left(\frac{n\pi}{a}x\right) \sin\left(\frac{m\pi}{b}y\right) \quad \text{for } m, n = 1, 2, \dots,$$

whose corresponding eigenvalues are $\lambda_{mn} = -[(\frac{n\pi}{a})^2 + (\frac{m\pi}{b})^2]$.

Inserting the eigenfunctions and the eigenvalues in Eq. (22.55), we obtain

$$\begin{aligned} G(\mathbf{r}, \mathbf{r}') &= G(x, y; x', y') = \sum_{m,n=1}^{\infty} \frac{u_{mn}(x, y) u_{mn}(x', y')}{\lambda_{mn}} \\ &= -\frac{4}{ab} \sum_{m,n=1}^{\infty} \frac{\sin(\frac{n\pi}{a}x) \sin(\frac{m\pi}{b}y) \sin(\frac{n\pi}{a}x') \sin(\frac{m\pi}{b}y')}{(\frac{n\pi}{a})^2 + (\frac{m\pi}{b})^2}, \end{aligned}$$

where we changed \mathbf{x} to \mathbf{r} and \mathbf{y} to \mathbf{r}' . Note that the eigenvalues are never zero; thus, $G(\mathbf{r}, \mathbf{r}')$ is well-defined.

⁴The inner product is defined as a double integral over the rectangle.

In the preceding example, zero was not an eigenvalue of \mathbf{L}_x . This condition must hold when a Green's function is expanded in terms of eigenfunctions. In physical applications, certain conditions (which have nothing to do with the BCs) exclude the zero eigenvalue automatically when they are applied to the Green's function. For instance, the condition that the Green's function remain finite at the origin is severe enough to exclude the zero eigenvalue.

Example 22.5.2 Let us consider the two-dimensional Dirichlet BVP $\nabla^2 u = f$, with $u = 0$ on a circle of radius a . If we consider only the BCs and ask whether zero is an eigenvalue of ∇^2 , the answer will be yes, as the following argument shows.

The most general solution to the zero-eigenvalue equation, $\nabla^2 u = 0$, in polar coordinates can be obtained by the method of separation of variables:

$$u(\rho, \varphi) = A + B \ln \rho + \sum_{n=1}^{\infty} (b_n \rho^n + b'_n \rho^{-n}) \cos n\varphi + \sum_{n=1}^{\infty} (c_n \rho^n + c'_n \rho^{-n}) \sin n\varphi. \quad (22.56)$$

Invoking the BC gives

$$0 = u(a, \varphi) = A + B \ln a + \sum_{n=1}^{\infty} (b_n a^n + b'_n a^{-n}) \cos n\varphi + \sum_{n=1}^{\infty} (c_n a^n + c'_n a^{-n}) \sin n\varphi,$$

which holds for arbitrary φ if and only if

$$A = -B \ln a, \quad b'_n = -b_n a^{2n}, \quad c'_n = -c_n a^{2n}.$$

Substituting in (22.56) gives

$$u(\rho, \varphi) = B \ln \left(\frac{\rho}{a} \right) + \sum_{n=1}^{\infty} \left(\rho^n - \frac{a^{2n}}{\rho^n} \right) (b_n \cos n\varphi + c_n \sin n\varphi). \quad (22.57)$$

Thus, if we demand nothing beyond the BCs, ∇^2 will have a nontrivial eigen-solution corresponding to the zero eigenvalue, given by Eq. (22.57).

Physical reality, however, demands that $u(\rho, \varphi)$ be well-behaved at the origin. This condition sets B , b'_n , and c'_n of Eq. (22.56) equal to zero. The BCs then make the remaining coefficients in (22.56) vanish. Thus, the demand that $u(\rho, \varphi)$ be well-behaved at $\rho = 0$ turns the situation completely around and ensures the nonexistence of a zero eigenvalue for the Laplacian, which in turn guarantees the existence of a GF.

In many cases the operator \mathbf{L}_x as a whole is not amenable to a full Sturm-Liouville treatment, and as such will not yield orthonormal eigenvectors in terms of which the GF can be expanded. However, it may happen that

\mathbf{L}_x can be broken up into two pieces one of which is an S-L operator. In such a case, the GF can be found as follows: Suppose that \mathbf{L}_1 and \mathbf{L}_2 are two *commuting* operators with \mathbf{L}_2 an S-L operator whose eigenvalues and eigenfunctions are known. Since \mathbf{L}_2 commutes with \mathbf{L}_1 , it can be regarded as a constant as far as operations with (and on) \mathbf{L}_1 are concerned. In particular, $(\mathbf{L}_1 + \mathbf{L}_2)\mathbf{G} = \mathbf{1}$ can be regarded as an operator equation in \mathbf{L}_1 *alone* with \mathbf{L}_2 treated as a constant. Let \mathbf{x}_1 denote the subset of the variables on which \mathbf{L}_1 acts, and let \mathbf{x}_2 denote the remainder of the coordinates. Then we can write $\delta(\mathbf{x} - \mathbf{y}) = \delta(\mathbf{x}_1 - \mathbf{y}_1)\delta(\mathbf{x}_2 - \mathbf{y}_2)$. Now let $G_1(\mathbf{x}_1, \mathbf{y}_1; k)$ denote the Green's function for $\mathbf{L}_1 + k$, where k is a constant. Then it is easily verified that

$$G(\mathbf{x}, \mathbf{y}) = G_1(\mathbf{x}_1, \mathbf{y}_1; \mathbf{L}_2)\delta(\mathbf{x}_2 - \mathbf{y}_2). \quad (22.58)$$

In fact,

$$(\mathbf{L}_1 + \mathbf{L}_2)G(\mathbf{x}, \mathbf{y}) = \underbrace{[(\mathbf{L}_1 + \mathbf{L}_2)G_1(\mathbf{x}_1, \mathbf{y}_1; \mathbf{L}_2)]}_{=\delta(\mathbf{x}_1 - \mathbf{y}_1) \text{ by definition of } G_1} \delta(\mathbf{x}_2 - \mathbf{y}_2).$$

Once G_1 is found as a function of \mathbf{L}_2 , it can operate on $\delta(\mathbf{x}_2 - \mathbf{y}_2)$ to yield the desired Green's function. The following example illustrates the technique.

Example 22.5.3 Let us evaluate the Dirichlet GF for the two-dimensional Helmholtz operator $\nabla^2 - k^2$ in the infinite strip $0 \leq x \leq a$, $-\infty < y < \infty$. Let $\mathbf{L}_1 = \partial^2/\partial y^2 - k^2$ and $\mathbf{L}_2 = \partial^2/\partial x^2$. Then,

$$G(\mathbf{r}, \mathbf{r}') \equiv G(x, x', y, y') = G_1(y, y'; \mathbf{L}_2)\delta(x - x'),$$

where $(d^2/dy^2 - \mu^2)G_1 = \delta(y - y')$, $\mu^2 \equiv k^2 - \mathbf{L}_2$, and $G_1(y = -\infty) = G_1(y = \infty) = 0$. The GF G_1 can be readily found (see Problem 20.12):

$$G_1(y, y'; \mathbf{L}_2) = -\frac{e^{-\mu|y-y'|}}{2\mu} = -\frac{e^{-\sqrt{k^2 - \mathbf{L}_2}|y-y'|}}{2\sqrt{k^2 - \mathbf{L}_2}}.$$

The full GF is then

$$G(\mathbf{r}, \mathbf{r}') = \left(-\frac{e^{-\sqrt{k^2 - \mathbf{L}_2}|y-y'|}}{2\sqrt{k^2 - \mathbf{L}_2}} \right) \delta(x - x'). \quad (22.59)$$

The operator \mathbf{L}_2 constitutes an S-L system with eigenvalues $\lambda_n = -(n\pi x/a)^2$ and eigenfunctions $u_n(x) = \sqrt{2/a} \sin(n\pi x/a)$ where $n = 1, 2, \dots$. Therefore, the delta function $\delta(x - x')$ can be expanded in terms of these eigenfunctions:

$$\delta(x - x') = \frac{2}{a} \sum_{n=1}^{\infty} \sin\left(\frac{n\pi}{a}x\right) \sin\left(\frac{n\pi}{a}x'\right).$$

As $\mu = \sqrt{k^2 - \mathbf{L}_2}$ acts on the delta function, \mathbf{L}_2 operates on the first factor in the above expansion and gives λ_n . Thus, \mathbf{L}_2 in Eq. (22.59) can be replaced by $-(n\pi x/a)^2$, and we have

$$G(\mathbf{r}, \mathbf{r}') = -\frac{1}{a} \sum_{n=1}^{\infty} \left(-\frac{e^{-\sqrt{k^2 + (n\pi x/a)^2} |y-y'|}}{\sqrt{k^2 + (n\pi x/a)^2}} \right) \sin\left(\frac{n\pi}{a}x\right) \sin\left(\frac{n\pi}{a}x'\right).$$

Sometimes it is convenient to break an operator into more than two parts. In fact, in some cases it may be advantageous to define a set of commuting self-adjoint (differential) operators $\{\mathbf{M}_j\}$ such that the full operator \mathbf{L} can be written as $\mathbf{L} = \sum_j \mathbf{L}_j \mathbf{M}_j$ where the differential operators $\{\mathbf{L}_j\}$ act on variables on which the \mathbf{M}_j have no action. Since the \mathbf{M}_j 's commute among themselves, one can find simultaneous eigenfunctions for all of them. Then one expands part of the delta function in terms of these eigenfunctions in the hope that the ensuing problem becomes more manageable. The best way to appreciate this approach is via an example.

Example 22.5.4 Let us consider the Laplacian in spherical coordinates,

$$\nabla^2 u = \frac{1}{r^2} \frac{\partial}{\partial r} \left(r^2 \frac{\partial u}{\partial r} \right) + \frac{1}{r^2 \sin \theta} \left[\frac{\partial}{\partial \theta} \left(\sin \theta \frac{\partial u}{\partial \theta} \right) + \frac{\partial^2 u}{\partial \varphi^2} \right].$$

If we introduce

$$\begin{aligned} \mathbf{M}_1 u &= u, & \mathbf{L}_1 u &= \frac{1}{r^2} \frac{\partial}{\partial r} \left(r^2 \frac{\partial u}{\partial r} \right), \\ \mathbf{M}_2 u &= \frac{1}{\sin \theta} \left[\frac{\partial}{\partial \theta} \left(\sin \theta \frac{\partial u}{\partial \theta} \right) + \frac{\partial^2 u}{\partial \varphi^2} \right], & \mathbf{L}_2 u &= \frac{1}{r^2} u, \end{aligned} \quad (22.60)$$

the Laplacian becomes $\nabla^2 = \mathbf{L}_1 \mathbf{M}_1 + \mathbf{L}_2 \mathbf{M}_2$. The mutual eigenfunctions of \mathbf{M}_1 and \mathbf{M}_2 are simply those of \mathbf{M}_2 , which is (the negative of) the angular momentum operator discussed in Chap. 13, whose eigenfunctions are the spherical harmonics. We thus have $\mathbf{M}_2 Y_{lm}(\theta, \varphi) = -l(l+1) Y_{lm}(\theta, \varphi)$.

Let us expand the Green's function in terms of the spherical harmonics:

$$G(\mathbf{r}, \mathbf{r}') = \sum_{l,m} g_{lm}(r; r', \theta', \varphi') Y_{lm}(\theta, \varphi).$$

We also write the delta function as

$$\begin{aligned} \delta(\mathbf{r} - \mathbf{r}') &= \frac{\delta(r - r') \delta(\theta - \theta') \delta(\varphi - \varphi')}{r'^2 \sin \theta'} \\ &= \frac{\delta(r - r')}{r'^2} \sum_{l,m} Y_{lm}(\theta, \varphi) Y_{lm}^*(\theta', \varphi'), \end{aligned}$$

where we have used the completeness of the spherical harmonics. Substituting all of the above in $\nabla^2 G(\mathbf{r}, \mathbf{r}') = \delta(\mathbf{r} - \mathbf{r}')$, we obtain

$$\begin{aligned}
\nabla^2 G(\mathbf{r}, \mathbf{r}') &= (\mathbf{L}_1 \mathbf{M}_1 + \mathbf{L}_2 \mathbf{M}_2) \sum_{l,m} g_{lm}(r; r', \theta', \varphi') Y_{lm}(\theta, \varphi) \\
&= \sum_{l,m} \{[\mathbf{L}_1 - l(l+1)\mathbf{L}_2] g_{lm}(r; r', \theta', \varphi')\} Y_{lm}(\theta, \varphi) \\
&= \frac{\delta(r-r')}{r'^2} \sum_{l,m} Y_{lm}^*(\theta', \varphi') Y_{lm}(\theta, \varphi).
\end{aligned}$$

The orthogonality of the $Y_{lm}(\theta, \varphi)$ yields

$$[\mathbf{L}_1 - l(l+1)\mathbf{L}_2] g_{lm}(r; r', \theta', \varphi') = \frac{\delta(r-r')}{r'^2} Y_{lm}^*(\theta', \varphi').$$

This shows that the angular part of g_{lm} is simply $Y_{lm}^*(\theta', \varphi')$. Separating this from the dependence on \mathbf{r} and \mathbf{r}' and substituting for \mathbf{L}_1 and \mathbf{L}_2 , we obtain

$$\frac{1}{r^2} \frac{d}{dr} \left(r^2 \frac{d g_{lm}}{dr} \right) - \frac{l(l+1)}{r^2} g_{lm} = \frac{\delta(r-r')}{r^2}, \quad (22.61)$$

where this last g_{lm} is a function of r and r' only. The techniques of Chap. 20 can be employed to solve Eq. (22.61) (see Problem 22.29).

The separation of the full operator into two “smaller” operators can also be used for cases in which both operators have eigenvalues and eigenvectors. The result of such an approach will, of course, be equivalent to the eigenfunction-expansion approach. However, there will be an arbitrariness in the operator approach: Which operator are we to choose as our \mathbf{L}_1 ? While in Example 22.5.3 the choice was clear (the operator that had no eigenfunctions), here either operator can be chosen as \mathbf{L}_1 . The ensuing GFs will be equivalent, and the series representing them will be convergent, of course. However, the *rate* of convergence may be different for the two. It turns out, for example, that if we are interested in $G(x, y; x', y')$ for the two-dimensional Laplacian at points (x, y) whose y -coordinates are far from y' , then the appropriate expansion is obtained by letting $\mathbf{L}_1 = \partial^2/\partial y^2$, that is, an expansion in terms of x eigenfunctions. On the other hand, if the Green's function is to be calculated for a point (x, y) whose x -coordinate is far away from the singular point (x', y') , then the appropriate expansion is obtained by letting $\mathbf{L}_1 = \partial^2/\partial x^2$.

22.6 Problems

22.1 Find the GF for the Dirichlet BVP in two dimensions if D is the UHP and ∂D is the x -axis.

22.2 Add $f(\mathbf{r}'')$ to $H(\mathbf{r}, \mathbf{r}'')$ in Example 22.1.2 and retrace the argument given there to show that $f(\mathbf{r}'') = 0$.

22.3 Use the method of images to find the GF for the Laplacian in the exterior region of a “sphere” of radius a in two and three dimensions.

22.4 Derive Eq. (22.7) from Eq. (22.6).

22.5 Using Eq. (22.7) with $\rho = 0$, show that if $g(\theta', \varphi') = V_0$, the potential at any point inside the sphere is V_0 .

22.6 Find the BC that the GF must satisfy in order for the solution u to be representable in terms of the GF when the BC on u is mixed, as in Eq. (22.10). Assume a self-adjoint SOLPDO of the elliptic type, and consider the two cases $\alpha(\mathbf{x}) \neq 0$ and $\beta(\mathbf{x}) \neq 0$ for $\mathbf{x} \in \partial D$. Hint: In each case, divide the mixed BC equation by the nonzero coefficient, substitute the result in the Green's identity, and set the coefficient of the u term in the ∂D integral equal to zero.

22.7 Show that the diffusion operator satisfies

$$\mathbf{L}_{\mathbf{x},t}G(\mathbf{x}, \mathbf{y}; t - \tau) = \delta(\mathbf{x} - \mathbf{y})\delta(t - \tau).$$

Hint: Use

$$\frac{\partial \theta}{\partial t}(t - \tau) = \delta(t - \tau).$$

22.8 Show that for $m = 3$ the expression for $G_s(\mathbf{r})$ given by Eq. (22.36) reduces to $G_s(\mathbf{r}) = -e^{-\mu r}/(4\pi r)$.

22.9 The time-independent Schrödinger equation can be rewritten as

$$(\nabla^2 + k^2)\Psi - \frac{2\mu}{\hbar^2}V(\mathbf{r})\Psi = 0,$$

where $k^2 = 2\mu E/\hbar^2$ and μ is the mass of the particle.

- Use techniques of Sect. 21.4 to write an integral equation for Ψ .
- Show that the Neumann series solution of the integral equation converges only if

$$\int_{\mathbb{R}^3} |V(\mathbf{r})|^2 d^3r < \frac{2\pi\hbar^4 \text{Im} k}{\mu^2}.$$

- Assume that the potential is of Yukawa type: $V(\mathbf{r}) = g^2 e^{-\kappa r}/r$. Find a condition between the (bound state) energy and the potential strength g that ensures convergence of the Neumann series.

22.10 Derive Eq. (22.29).

22.11 Derive Eq. (22.31) using the procedure outlined for parabolic equations.

22.12 Consider GF for the Helmholtz operator $\nabla^2 + \mu^2$ in two dimensions.

- Show that

$$G(\mathbf{r}, \mathbf{r}') = -\frac{i}{4}H_0^{(1)}(\mu|\mathbf{r} - \mathbf{r}'|) + H(\mathbf{r}, \mathbf{r}'),$$

where $H(\mathbf{r}, \mathbf{r}')$ satisfies the homogeneous Helmholtz equation.

- (b) Separate the variables and use the fact that H is regular at $\mathbf{r} = \mathbf{r}'$ to show that H can be written as

$$H(\mathbf{r}, \mathbf{r}') = \sum_{n=0}^{\infty} J_n(\mu r) [a_n(\mathbf{r}') \cos n\theta + b_n(\mathbf{r}') \sin n\theta].$$

- (c) Now assume a circular boundary of radius a and the BC $G(\mathbf{a}, \mathbf{r}') = 0$, in which \mathbf{a} is a vector from the origin to the circular boundary. Using this BC, show that

$$a_0(\mathbf{r}') = \frac{i}{8\pi J_0(\mu a)} \int_0^{2\pi} H_0^{(1)}(\mu \sqrt{a^2 + r'^2 - 2ar' \cos(\theta - \theta')}) d\theta,$$

$$a_n(\mathbf{r}') = \frac{i}{4\pi J_n(\mu a)} \times \int_0^{2\pi} H_0^{(1)}(\mu \sqrt{a^2 + r'^2 - 2ar' \cos(\theta - \theta')}) \cos n\theta d\theta,$$

$$b_n(\mathbf{r}') = \frac{i}{4\pi J_n(\mu a)} \times \int_0^{2\pi} H_0^{(1)}(\mu \sqrt{a^2 + r'^2 - 2ar' \cos(\theta - \theta')}) \sin n\theta d\theta.$$

These equations completely determine $H(\mathbf{r}, \mathbf{r}')$ and therefore $G(\mathbf{r}, \mathbf{r}')$.

22.13 Use the Fourier transform technique to find the singular part of the GF for the diffusion equation in one and three dimensions. Compare your results with that obtained in Sect. 22.4.3.

22.14 Show directly that both $G_s^{(\text{ret})}$ and $G_s^{(\text{adv})}$ satisfy $\nabla^2 G = \delta(\mathbf{r})\delta(t)$ in three dimensions.

22.15 Consider a rectangular box with sides a , b , and c located in the first octant with one corner at the origin. Let D denote the inside of this box.

- (a) Show that zero cannot be an eigenvalue of the Laplacian operator with the Dirichlet BCs on ∂D .
 (b) Find the GF for this Dirichlet BVP.

22.16 Find the GF for the two-dimensional Helmholtz equation $(\nabla^2 + k^2)u = 0$ on the rectangle $0 \leq x \leq a$, $0 \leq y \leq b$.

22.17 For the operator $ad^2/dx^2 + b$, where $a > 0$ and $b < 0$, find the singular part of the one-dimensional GF.

22.18 Calculate the GF of the two-dimensional Laplacian operator appropriate for Neumann BCs on the rectangle $0 \leq x \leq a$, $0 \leq y \leq b$.

22.19 For the Helmholtz operator $\nabla^2 - k^2$ in the half-space $z \geq 0$, find the three-dimensional Dirichlet GF.

22.20 For the Helmholtz operator $\nabla^2 - k^2$ in the half-space $z \leq 0$, find the three-dimensional Neumann GF.

22.21 Using the integral form of the Schrödinger equation in three dimensions, show that an attractive delta-function potential $V(\mathbf{r}) = -V_0\delta(\mathbf{r} - \mathbf{a})$ does not have a bound state ($E < 0$). Contrast this with the result of Example 21.4.1.

22.22 By taking the Fourier transform of both sides of the integral form of the Schrödinger equation, show that for bound-state problems ($E < 0$), the equation in “momentum space” can be written as

$$\tilde{\psi}(\mathbf{p}) = -\frac{2\mu}{(2\pi)^3/2\hbar^2} \left(\frac{1}{\kappa^2 + p^2} \right) \int \tilde{V}(\mathbf{p} - \mathbf{q}) \tilde{\psi}(\mathbf{q}) d^3q,$$

where $\kappa^2 = -2\mu E/\hbar^2$.

22.23 Write the bound-state Schrödinger integral equation for a non-local potential, noting that $G(\mathbf{r}, \mathbf{r}') = e^{-\kappa|\mathbf{r}-\mathbf{r}'|}/|\mathbf{r} - \mathbf{r}'|$, where $\kappa^2 = -2\mu E/\hbar^2$ and μ is the mass of the bound particle. The homogeneous solution is zero, as is always the case with bound states.

(a) Assuming that the potential is of the form $V(\mathbf{r}, \mathbf{r}') = -g^2U(\mathbf{r})U(\mathbf{r}')$, show that a solution to the Schrödinger equation exists iff

$$\frac{\mu g^2}{2\pi\hbar^2} \int_{\mathbb{R}^3} d^3r \int_{\mathbb{R}^3} d^3r' \frac{e^{-\kappa|\mathbf{r}-\mathbf{r}'|}}{|\mathbf{r} - \mathbf{r}'|} U(\mathbf{r})U(\mathbf{r}') = 1. \quad (22.62)$$

(b) Taking $U(\mathbf{r}) = e^{-\alpha r}/r$, show that the condition in (22.62) becomes

$$\frac{4\pi\mu g^2}{\alpha\hbar^2} \left[\frac{1}{(\alpha + \kappa)^2} \right] = 1.$$

(c) Since $\kappa > 0$, prove that the equation in (b) has a unique solution only if $g^2 > \hbar^2\alpha^2/(4\pi\mu)$, in which case the bound-state energy is

$$E = -\frac{\hbar^2}{2\mu} \left[\left(\frac{4\pi\mu g^2}{\alpha\hbar^2} \right)^{1/2} - \alpha \right]^2.$$

22.24 Repeat calculations in Sects. 22.4.1 and 22.4.2 for $m = 2$.

22.25 In this problem, the dimension m is three.

(a) Derive the following identities:

$$\begin{aligned} \nabla^2 \left[\frac{f(r)}{r} \right] &= \frac{\nabla^2 f}{r} - \frac{2}{r^2} \frac{\partial f}{\partial r} + \nabla^2 \left(\frac{1}{r} \right), \\ \frac{d\epsilon(t)}{dt} &= 2\delta(t), \quad \nabla^2 \delta(t \pm r) = \delta''(t \pm r) \pm \frac{2}{r} \delta'(t \pm r), \end{aligned}$$

where $\epsilon(t) = \theta(t) - \theta(-t)$.

- (b) Use the results of (a) to show that the GF [Eq. (22.47)] derived from the principal value of the ω integration for the wave equation in three dimensions satisfies only the homogeneous PDE. Hint: Use $\nabla^2(1/r) = 4\pi\delta(\mathbf{r})$.

22.26 Calculate the retarded GF for the wave operator in two dimensions and show that it is equal to

$$G_s^{(\text{ret})}(\mathbf{r}, t) = \frac{\theta(t)}{2\pi\sqrt{t^2 - r^2}}.$$

Now use this result to obtain the GF for any even number of dimensions:

$$G_s^{(\text{ret})}(\mathbf{r}, t) = \frac{\theta(t)}{2\pi} \left(-\frac{1}{2\pi r} \frac{\partial}{\partial r} \right)^{n-1} \left[\frac{1}{\sqrt{t^2 - r^2}} \right] \quad \text{for } n = m/2.$$

22.27 (a) Find the singular part of the retarded GF and the advanced GF for the wave equation in three dimensions using Eqs. (22.48) and (22.49). Hint: $J_{1/2}(kr) = \sqrt{2/\pi kr} \sin kr$.

- (b) Use (a) and Eq. (22.51) to show that

$$\lim_{\epsilon \rightarrow 0} \left\{ \frac{1}{[r^2 + (-it + \epsilon)^2]} - \frac{1}{[r^2 + (it + \epsilon)^2]} \right\} = -\frac{i\pi}{r} [\delta(t+r) - \delta(t-r)].$$

22.28 Show that the eigenfunction expansion of the GF for the Dirichlet BVP for the Laplacian operator in two dimensions for which the region of interest is the interior of a circle of radius a is

$$G(\mathbf{r}, \mathbf{r}') = -\frac{2}{\pi} \sum_{n=0}^{\infty} \sum_{m=1}^{\infty} \frac{\epsilon_n J_n(\frac{\rho}{a} x_{nm}) J_n(\frac{\rho'}{a} x_{nm}) \cos n(\varphi - \varphi')}{J_{n+1}^2(x_{nm}) x_{nm}^2},$$

where $\epsilon_0 = \frac{1}{2}$ and $\epsilon_n = 1$ for $n \geq 1$, and use has been made of Problem 15.39.

22.29 Go back to Example 22.5.4, and

- complete the calculations therein;
- find the GF for the Laplacian with Dirichlet BCs on two concentric spheres of radii a and b , with $a < b$.
- Consider the case where $a \rightarrow 0$ and $b \rightarrow \infty$ and compare the result with the singular part of the GF for the Laplacian.

22.30 Solve the Dirichlet BVP for the operator $\nabla^2 - k^2$ in the region $0 \leq x \leq a$, $0 \leq y \leq b$, $-\infty < z < \infty$. Hint: Separate the operator into \mathbf{L}_1 and \mathbf{L}_2 .

22.31 Solve the problem of Example 22.5.1 using the separation of operator technique and show that the two results are equivalent.

22.32 Use the operator separation technique to calculate the Dirichlet GF for the two-dimensional operator $\nabla^2 - k^2$ on the rectangle $0 \leq x \leq a$, $0 \leq y \leq b$. Also obtain an eigenfunction expansion for this GF.

22.33 Use the operator separation technique to find the three-dimensional Dirichlet GF for the Laplacian in a circular cylinder of radius a and height h .

22.34 Calculate the singular part of the GF for the three-dimensional free Schrödinger operator

$$i\hbar\frac{\partial}{\partial t} - \frac{\hbar^2}{2\mu}\nabla^2.$$

22.35 Use the operator separation technique to show that

(a) the GF for the Helmholtz operator $\nabla^2 + k^2$ in three dimensions is

$$G(\mathbf{r}, \mathbf{r}') = -ik \sum_{l=0}^{\infty} \sum_{m=-l}^l j_l(kr_{<})h_l(kr_{>})Y_{lm}(\theta, \varphi)Y_{lm}^*(\theta', \varphi'),$$

where $r_{<}$ ($r_{>}$) is the smaller (larger) of r and r' and j_l and h_l are the spherical Bessel and Hankel functions, respectively. No explicit BCs are assumed except that there is regularity at $r = 0$ and that $G(\mathbf{r}, \mathbf{r}') \rightarrow 0$ for $|\mathbf{r}| \rightarrow \infty$.

(b) Obtain the identity

$$\frac{e^{ik|\mathbf{r}-\mathbf{r}'|}}{4\pi|\mathbf{r}-\mathbf{r}'|} = ik \sum_{l=0}^{\infty} \sum_{m=-l}^l j_l(kr_{<})h_l(kr_{>})Y_{lm}(\theta, \varphi)Y_{lm}^*(\theta', \varphi').$$

(c) Derive the plane wave expansion [see Eq. (19.46)]

$$e^{i\mathbf{k}\cdot\mathbf{r}} = 4\pi \sum_{l=0}^{\infty} \sum_{m=-l}^l i^l j_l(kr)Y_{lm}^*(\theta', \varphi')Y_{lm}(\theta, \varphi),$$

where θ' and φ' are assumed to be the angular coordinates of \mathbf{k} . Hint: Let $|\mathbf{r}'| \rightarrow \infty$, and use

$$|\mathbf{r}-\mathbf{r}'| = (r'^2 + r^2 - 2\mathbf{r}\cdot\mathbf{r}')^{1/2} \rightarrow r' - \frac{\mathbf{r}'\cdot\mathbf{r}}{r'}$$

and the asymptotic formula $h_l^{(1)}(z) \rightarrow (1/z)e^{i[z+(l+1)(\pi/2)]}$, valid for large z .

Part VII

Groups and Their Representations

The tale of mathematics and physics has been one of love and hate, of harmony and discord, and of friendship and animosity. From their simultaneous inception in the shape of calculus in the seventeenth century, through an intense and interactive development in the eighteenth and most of the nineteenth century, to an estrangement in the latter part of the nineteenth and the beginning of the twentieth century, mathematics and physics have experienced the best of times and the worst of times. Sometimes, as in the case of calculus, nature dictates a mathematical dialect in which the narrative of physics is to be spoken. Other times, man, building upon that dialect, develops a sophisticated language in which—as in the case of Lagrangian and Hamiltonian interpretation of dynamics—the narrative of physics is set in the most beautiful poetry. But the happiest courtship, and the most exhilarating relationship, takes place when a discovery in physics leads to a development in mathematics that in turn feeds back into a better understanding of physics, leading to new ideas or a new interpretation of existing ideas. Such a state of affairs began in the 1930s with the advent of quantum mechanics, and, after a lull of about 30 years, revived in the late 1960s. We are fortunate to be witnesses to one of the most productive collaborations between the physics and mathematics communities in the history of both.

It is not an exaggeration to say that the single most important catalyst that has facilitated this collaboration is the idea of **symmetry** the study of which is the main topic of the theory of groups, the subject of this chapter. Although group theory, in one form or another, was known to mathematicians as early as the beginning of the nineteenth century, it found its way into physics only after the invention of quantum theory, and in particular, Dirac's interpretation of it in the language of transformation theory. Eugene Wigner, in his seminal paper¹ of 1939 in which he applied group theoretical ideas to Lorentz transformations, paved the way for the marriage of group theory and quantum mechanics. Today, in every application of quantum theory, be it to atoms, molecules, solids, or elementary particles such as quarks and leptons, group-theoretical techniques are indispensable.

¹E.P. Wigner, On the Unitary Representations of the Inhomogeneous Lorentz Group, *Ann. of Math.* **40** (1939) 149–204.

23.1 Groups

The prototype of a group is a transformation group, the set of invertible mappings of a set onto itself. Let us elaborate on this. First, we take mappings because they are the most general operations performed between sets. From a physical standpoint, mappings are essential in understanding the symmetries and other basic properties of a theory. For instance, rotations and translations are mappings of space. Second, the mappings ought to be on a single set, because we want to be able to compose any given two mappings. We cannot compose $f : A \rightarrow B$ and $g : A \rightarrow B$, because, by necessity, the domain of the second must be a subset of the image of the first. With three sets, and $A \xrightarrow{f} B, B \xrightarrow{g} C$, even if the composition $f \circ g$ is defined, $g \circ f$ will not be. Third, we want to be able to undo the mapping. Physically, this means that we should be able to retrace our path to our original position in the set. This can happen only if all mappings of interest have an inverse. Finally, we note that composing a mapping with its inverse yields identity. Therefore, the identity map must also be included in the set of mappings.

We shall come back to transformation groups frequently. In fact, almost all groups considered in this book are transformation groups. However, as in our study of vector spaces in Chap. 2, it is convenient to give a general description of (abstract) groups.

Group defined

Definition 23.1.1 A **group** is a set G together with an *associative* binary operation $G \times G \rightarrow G$ called **multiplication**—and denoted generically by \star —having the following properties:

1. There exists a unique element² $e \in G$ called the **identity** such that $e \star g = g \star e = g$.
2. For every element $g \in G$, there exists an element g^{-1} , called the **inverse** of g , such that $g \star g^{-1} = g^{-1} \star g = e$.

To emphasize the binary operation of a group, we designate it as (G, \star) .

Historical Notes

Évariste Galois (1811–1832) was definitely not the stereotypically dull mathematician, quietly creating theorems and teaching students. He was a political firebrand whose life ended in a mysterious duel when he was only 21 years old. An ardent republican, he was in the unfortunate position of having Cauchy, an ardent royalist, as the only French mathematician capable of understanding the significance of his work. His professional accomplishments (fewer than 100 pages, much of which was published posthumously) received the attention they deserved many years later. It is truly sad to realize that for decades, work from the man credited with the foundation of group theory were lost to the world of mathematics. Galois's early years were relatively happy. His father, a liberal thinker known for his wit, was director of a boarding school and later mayor of Bourg-la-Reine. Galois's mother took charge of his early education. A stubborn, eccentric woman, she mixed classical culture with a fairly stern religious upbringing.

The young Galois entered the College Louis-le-Grand in 1823, but found the harsh discipline imposed by church and political authorities difficult to bear. His interest in mathematics was sparked in class by Vernier, but Galois quickly tired of the elementary character of the material, preferring instead to read the more advanced original works on his



Évariste Galois
1811–1832

²To distinguish between identities of different groups, we sometimes write e_G for the identity of the group G .

own. After a flawed attempt to solve the general fifth-order equation, Galois submitted a paper to the *Académie des Sciences* in which he described the definitive solution with the aid of group theory, of which the young Galois can be considered the creator. However, this strong initial foray into the frontiers of mathematics was accompanied by tragedy and setback. A few weeks after the paper's submission, his father committed suicide, which Galois felt was largely to be blamed on those who politically persecuted his father. A month later the young mathematician failed the entrance examination to the Ecole Polytechnique, largely due to his refusal to answer in the form demanded by the examiner. Galois did gain entrance to a less prestigious school for the preparation of secondary-school teachers. While there he read some of Abel's results (published after Abel's death) and found that they contained some of the results he had submitted to the Academy including the proof of the impossibility of solving quintics. Cauchy, assigned as the judge for Galois's paper, suggested that he revise it in light of this new information. Galois instead wrote an entirely new manuscript and submitted it in competition for the grand prix in mathematics. Tragically, the manuscript was lost on the death of Fourier, who had been assigned to examine it, leaving Galois out of the competition. These events, fueled by a later, unfair dismissal of another of his papers by Poisson, seem to have driven Galois toward political radicalism and rebellion during the renewed turmoil then plaguing France. He was arrested several times for his agitations, although he continued work on mathematics while in custody. On May 30, 1832, he was wounded in a duel with an unknown adversary, the duel perhaps caused by an unhappy love affair. His funeral three days later sparked riots that raged through Paris in the days that followed.

The delay in recognition of the true scope of Galois's scant but amazing work stemmed partly from the originality of his ideas and the lack of competent local reviewers. Cauchy left France after seeing only the early parts of Galois's work, and much of the rest remained unnoticed until Liouville prepared the later manuscripts for publication a decade after Galois's death. Their true value wasn't appreciated for another two decades. The young mathematician himself added to the difficulty by deliberately making his writing so terse that the "established scientists" for whom he had so much disdain could not understand it. Those fortunate enough to appreciate Galois's work found fertile ground in mathematical research, in such fundamental fields as group theory and modern algebra, for decades to come.

If the underlying set G has a finite number of elements, the group is called **finite**, and its number of elements, denoted by $|G|$, is called the **order** of G . We can also have an infinite group whose cardinality can be countable or continuous.

order of a group

Given an element $a \in G$, we write

$$a^k \equiv \underbrace{a \star a \star \cdots \star a}_{k \text{ times}}, \quad a^{-m} \equiv \underbrace{a^{-1} \star a^{-1} \star \cdots \star a^{-1}}_{m \text{ times}}$$

and note that

$$a^i \star a^j = a^{i+j} \quad \text{for all } i, j \in \mathbb{Z}.$$

Example 23.1.2 The following are examples of familiar sets that have group properties.

- The set \mathbb{Z} of integers under the binary operation of addition forms a group whose identity element is 0 and the inverse of n is $-n$. This group is countably infinite.
- The set $\{-1, +1\}$, under the binary operation of multiplication, forms a group whose identity element is 1 and the inverse of each element is itself. This group is finite.
- The set $\{-1, +1, -i, +i\}$, under the binary operation of multiplication, forms a finite group whose identity element is 1.

- (d) The set \mathbb{R} , under the binary operation of addition, forms a group whose identity element is 0 and the inverse of r is $-r$. This group is uncountably infinite.
- (e) The set \mathbb{R}^+ (\mathbb{Q}^+) of positive real (rational) numbers, under the binary operation of multiplication, forms a group whose identity element is 1 and the inverse of r is $1/r$. This group is uncountably (countably) infinite.
- (f) The set \mathbb{C} , under the binary operation of addition, forms a group whose identity element is 0 and the inverse of z is $-z$. This group is uncountably infinite.
- (g) The uncountably infinite set $\mathbb{C} - \{0\}$ of all complex numbers except 0, under the binary operation of multiplication, forms a group whose identity element is 1 and the inverse of z is $1/z$.
- (h) The uncountably infinite set \mathcal{V} of vectors in a vector space, under the binary operation of addition, forms a group whose identity element is the zero vector and the inverse of $|a\rangle$ is $-|a\rangle$.
- (i) The set of invertible $n \times n$ matrices, under the binary operation of multiplication, forms a group whose identity element is the $n \times n$ unit matrix and the inverse of A is A^{-1} . This group is uncountably infinite.

The reader is urged to verify that each set given above is indeed a group.

In general, the elements of a group do not commute. Those groups whose elements do commute are so important that we give them a special name:

abelian groups defined

Definition 23.1.3 A group (G, \star) is called **abelian** or **commutative** if $a \star b = b \star a$ for all $a, b \in G$. It is common to denote the binary operation of an abelian group by $+$.

All groups of Example 23.1.2 are abelian except the last.

Example 23.1.4 Let \mathbf{A} be a vector potential that gives rise to a magnetic field \mathbf{B} . The set of transformations of \mathbf{A} that give rise to the same \mathbf{B} is an abelian group. In fact, such transformations simply add the gradient of a function to \mathbf{A} . The reader can check the details.

symmetric or permutation group

The reader may also verify that the set of invertible mappings $f : S \rightarrow S$, i.e., the **set of transformations** of S , is indeed a (nonabelian) group. If S has n elements, this group is denoted by S_n and is called the **symmetric group** of S . S_n is a nonabelian (unless $n \leq 2$) finite group that has $n!$ elements. An element g of S_n is usually denoted by two rows, the top row being S itself—usually taken to be $1, 2, \dots, n$ —and the bottom row its image under g . For example, $g \equiv \begin{pmatrix} 1 & 2 & 3 & 4 \\ 2 & 3 & 4 & 1 \end{pmatrix}$ is an element of S_4 such that $g(1) = 2$, $g(2) = 3$, $g(3) = 4$, and $g(4) = 1$.

Consider two groups, the set of vectors in a plane $((x, y), +)$ and the set of complex numbers $(\mathbb{C}, +)$, both under addition. Although these are two different groups, the difference is superficial. We have seen similar differences in disguise in the context of vector spaces and the notion of isomorphism. The same notion applies to group theory:

Definition 23.1.5 Let (G, \star) and (H, \bullet) be groups. A map $f : G \rightarrow H$ is called a **homomorphism** if

$$f(a \star b) = f(a) \bullet f(b) \quad \forall a, b \in G.$$

homomorphism,
isomorphism, and
automorphism

An **isomorphism** is a homomorphism that is also a bijection. Two groups are **isomorphic**, denoted by $G \cong H$, if there is an isomorphism $f : G \rightarrow H$. An isomorphism of a group onto itself is called an **automorphism**.

An immediate consequence of this definition is that $f(e_G) = e_H$ and $f(g^{-1}) = [f(g)]^{-1}$ (see Problem 23.9).

Example 23.1.6 Let G be any group and $\{1\}$ the multiplicative group consisting of the single number 1. It is straightforward to show that $f : G \rightarrow \{1\}$, given by (the only function available!) $f(g) = 1$ for all $g \in G$ is a homomorphism. This homomorphism is called the **trivial** (or sometimes, **symmetric**) homomorphism.

trivial homomorphism

The establishment of isomorphism $f : \mathbb{R}^2 \rightarrow \mathbb{C}$ between $((x, y), +)$, and $(\mathbb{C}, +)$ is trivial: Just write $f(x, y) = x + iy$. A less trivial isomorphism is the exponential map, $\exp : (\mathbb{R}, +) \rightarrow (\mathbb{R}^+, \cdot)$. The reader may verify that this is a homomorphism (in particular, it maps addition to multiplication) and that it is one-to-one.

We have noted that the set of invertible maps of a set forms a group. A very important special case of this is when the set is a vector space \mathcal{V} and the maps are all *linear*.

general linear group

Box 23.1.7 The **general linear group** of a vector space \mathcal{V} , denoted by $GL(\mathcal{V})$, is the set of all invertible endomorphisms of \mathcal{V} . In particular, when $\mathcal{V} = \mathbb{C}^n$, we usually write $GL(n, \mathbb{C})$ instead of $GL(\mathbb{C}^n)$ with similar notation for \mathbb{R} .

It is sometimes convenient to display a finite group $G = \{g_i\}_{i=1}^{|G|}$ as a $|G| \times |G|$ table, called the **group multiplication table**, in which the intersection of the i th row and j th column is occupied by $g_i \star g_j$. Because of its trivial multiplication, the identity is usually omitted from the table.

group multiplication
table

23.2 Subgroups

It is customary to write ab instead of $a \star b$. We shall adhere to this convention, but restore the \star as necessary to avoid any possible confusion.

Definition 23.2.1 A subset S of a group G is a **subgroup** of G if it is a group in its own right under the binary operation of G , i.e., if it contains the inverse of all its elements as well as the product of any pair of its elements.

subgroup defined

It follows from this definition that $e \in S$. It is also easy to show that the intersection of two subgroups is a subgroup (Problem 23.2).

Example 23.2.2 (Examples of subgroups)

- trivial subgroup
1. For any G , the subset $\{e\}$, consisting of the identity alone, is a subgroup of G called the **trivial subgroup** of G .
 2. $(\mathbb{Z}, +)$ is a subgroup of $(\mathbb{R}, +)$.
 3. The set of even integers (but not odd integers) is a subgroup of $(\mathbb{Z}, +)$. In fact, the set of all multiples of a positive integer m , denoted by $\mathbb{Z}m$, is a subgroup of \mathbb{Z} . It turns out that *all* subgroups of \mathbb{Z} are of this form.
 4. The subset of $GL(n, \mathbb{C})$ consisting of transformations that have unit determinant is a subgroup of $GL(n, \mathbb{C})$ because the identity transformation has unit determinant, the inverse of a transformation with unit determinant also has unit determinant, and the product of two transformations with unit determinants has unit determinant.

special linear group

Box 23.2.3 *The subgroup of $GL(n, \mathbb{C})$ consisting of elements having unit determinant is denoted by $SL(n, \mathbb{C})$ and is called the **special linear group**.*

- unitary, orthogonal, special unitary, and special orthogonal groups
5. The set of unitary transformations of \mathbb{C}^n , denoted by $U(n)$, is a subgroup of $GL(n, \mathbb{C})$ because the identity transformation is unitary, the inverse of a unitary transformation is also unitary, and the product of two unitary transformations is unitary.

Box 23.2.4 *The set of unitary transformations $U(n)$ is a subgroup of $GL(n, \mathbb{C})$ and is called the **unitary group**. Similarly, the set of orthogonal transformations of \mathbb{R}^n is a subgroup of $GL(n, \mathbb{R})$. It is denoted by $O(n)$ and called the **orthogonal group**.*

Each of these groups has a special subgroup whose elements have unit determinants. These are denoted by $SU(n)$ and $SO(n)$, and called **special unitary group** and **special orthogonal group**, respectively. The latter is also called the group of **rigid rotations** of \mathbb{R}^n .

6. Let $\mathbf{x}, \mathbf{y} \in \mathbb{R}^n$, and define an inner product on \mathbb{R}^n by

$$\mathbf{x} \cdot \mathbf{y} = -x_1y_1 - \cdots - x_p y_p + x_{p+1}y_{p+1} + \cdots + x_n y_n.$$

Denote the subset of $GL(n, \mathbb{R})$ that leaves this inner product invariant by ³ $O(p, n - p)$. Then $O(p, n - p)$ is a subgroup of $GL(n, \mathbb{R})$. The set of linear transformations among $O(p, n - p)$ that have determinant

³The reader is warned that what we have denoted by $O(p, n - p)$ is sometimes denoted by other authors by $O(n - p, p)$ or $O(n, p)$ or $O(p, n)$.

1 is denoted by $SO(p, n - p)$. The special case of $p = 0$ gives us the orthogonal and special orthogonal groups.⁴ When $n = 4$ and $p = 3$, we get the inner product of the special theory of relativity, and $O(3, 1)$, the set of Lorentz transformations, is called the **Lorentz group**. If one adds translations of \mathbb{R}^4 to $O(3, 1)$, one obtains the **Poincaré group**, $P(3, 1)$.

Lorentz and Poincaré groups

7. Let $\mathbf{x}, \mathbf{y} \in \mathbb{R}^{2n}$, and J the $2n \times 2n$ matrix $\begin{pmatrix} 0 & 1 \\ -1 & 0 \end{pmatrix}$, where 1 is the $n \times n$ unit matrix. The subset of $GL(2n, \mathbb{R})$ that leaves $\mathbf{x}^t J \mathbf{x}$, called an **anti-symmetric bilinear form**, invariant is a subgroup of $GL(2n, \mathbb{R})$ called the **symplectic group** and denoted by $Sp(2n, \mathbb{R})$. As we shall see in Chap. 28, the symplectic group is fundamental in the formal treatment of Hamiltonian mechanics.

symplectic group

8. Let S be a subgroup of G and $g \in G$. Then it is readily shown that the set

conjugate subgroup

$$g^{-1} S g \equiv \{g^{-1} s g \mid s \in S\}$$

is also a subgroup of G , called the **subgroup conjugate to S** under g , or the **subgroup g -conjugate to S** .

When discussing vector spaces, we noted that given any subset of a vector space, one could construct a subspace out of it by taking all possible linear combinations (natural operations of the vector space) of the vectors in the subset. We called the subspace thus obtained the *span of the subset*. The same procedure is applicable in group theory as well. If S is a subset of a group G , we can generate a subgroup out of S by collecting all possible products and inverses (natural operations of the group) of the elements of S . The reader may verify that the result is indeed a subgroup of G .

Definition 23.2.5 Let S be a subset of a group G . The **subgroup generated by S** , denoted by $\langle S \rangle$, is the union of S and all inverses and products of the elements of S .

subgroup generated by a subset

In the special case for which $S = \{a\}$, a single element, we use $\langle a \rangle$ instead of $\langle \{a\} \rangle$ and call it the **cyclic subgroup** generated by a . It is simply the collection of all integer powers of a .

cyclic subgroup

Definition 23.2.6 Let G be a group and $a, b \in G$. The **commutator** of a and b , denoted by $[a, b]$, is

commutator of group elements

$$[a, b] \equiv aba^{-1}b^{-1}.$$

The subgroup $\langle \bigcup_{a,b \in G} [a, b] \rangle$ generated by all commutators of G is called the **commutator subgroup** of G . The reader may verify that a group is abelian if and only if its commutator subgroup is the trivial subgroup, i.e., consists of only the identity element.

commutator subgroup of a group

⁴It is customary to write $O(n)$ and $SO(n)$ for $O(0, n)$ and $SO(0, n)$.

centralizer of an element in G and the center of G

Definition 23.2.7 Let $x \in G$. The set of elements of G that commute with x , denoted by $C_G(x)$, is called the **centralizer of x in G** . The set $Z(G)$ of elements of a group G that commute with all elements of G is called the **center** of G .

Theorem 23.2.8 $C_G(x)$ is a subgroup of G and $Z(G)$ is an abelian subgroup of G . Furthermore, G is abelian if and only if $Z(G) = G$.

Proof Proof is immediate from the definitions. \square

kernel of a homomorphism

Definition 23.2.9 Let G and H be groups and let $f : G \rightarrow H$ be a homomorphism. The **kernel** of f is

$$\ker f \equiv \{x \in G \mid f(x) = e \in H\}.$$

The reader may check that $\ker f$ is a subgroup of G , and $f(G)$ is a subgroup of H . These are the analogues of the same concepts encountered in vector spaces. In fact, if we treat a vector space as an additive group, with the zero vector as identity, then the above definition coincides with that of linear mappings and vector spaces.

Carrying the analogy further, we recall that given two subspaces \mathcal{U} and \mathcal{W} of a vector space \mathcal{V} , we denote by $\mathcal{U} + \mathcal{W}$ all vectors of \mathcal{V} that can be written as the sum of a vector in \mathcal{U} and a vector in \mathcal{W} . There is a similar concept in group theory that is sometimes very useful.

Definition 23.2.10 Let S and T be subsets of a group (G, \star) . Then one defines the product of these subsets as

$$S \star T \equiv \{s \star t \mid s \in S \text{ and } t \in T\}.$$

In particular, if T consists of a single element t , then

$$S \star t = \{s \star t \mid s \in S\}.$$

left and right cosets

As usual, we shall drop the \star and write ST and St . If S is a subgroup, then St is called a **right coset**⁵ of S in G . Similarly, tS is called a **left coset** of S in G . In either case, t is said to **represent** the coset.

Example 23.2.11 Let $G = \mathbb{R}^3$ treated as an additive abelian group, and let S be a plane through the origin. Then $t + S$ is S if $t \in S$ (see Problem 23.5); otherwise, it is a plane parallel to S . In fact, $t + S$ is simply the translation of all points of S by t .

Theorem 23.2.12 Any two right (left) cosets of a subgroup are either disjoint or identical.

⁵Some authors switch our right and left in their definition.

Proof Let S be a subgroup of G and suppose that $x \in Sa \cap Sb$. Then $x = s_1a = s_2b$ with $s_1, s_2 \in S$. Hence, $ab^{-1} = s_1^{-1}s_2 \in S$. By Problem 23.6, $Sa = Sb$. The left cosets can be treated in the same way. \square

A more “elegant” proof starts by showing that an equivalence relation can be defined on G by

$$a \bowtie b \iff ab^{-1} \in S$$

and then proving that the equivalence classes of this relation are cosets of S .

One interpretation of Theorem 23.2.12 is that a and b belong to the same right coset of S if and only if $ab^{-1} \in S$. A second interpretation is that a coset can be represented by any one of its elements (why?).

All cosets (right or left) of a subgroup S have the same cardinality as S itself. This can readily be established by considering the map $\phi : S \rightarrow Sa$ ($\phi : S \rightarrow aS$) with $\phi(s) = sa$ ($\phi(s) = as$) and showing that ϕ is bijective.

There are many instances both in physics and mathematics in which a collection of points of a given set represent a single quantity. For example, it is not simply the set of ratios of integers that comprise the set of rational numbers, but the set of certain collections of such ratios: The rational number $\frac{1}{2}$ represents $\frac{1}{2}, \frac{2}{4}, \frac{3}{6}$, etc. Similarly, a given magnetic field represents an infinitude of vector potentials each differing by a gradient from the others, and a physical state in quantum mechanics is an infinite number of wave functions differing from one another by a phase.

With the set of cosets constructed above, it is natural to ask whether they could be given an algebraic structure.⁶ The most natural such structure would clearly be that of a group: Given aS and bS define their product as abS . Would this operation turn the set of (left) cosets into a group? The following argument shows that it will, under an important restriction.

It is clear that the identity of such a group would be S itself. It is equally clear that we should have $(b^{-1}S)(bS) = S$, so that $(b^{-1}Sb)S = S$. It follows from Problem 23.5 that we must have $b^{-1}Sb \subset S$ for all $b \in G$. Now replace b with b^{-1} and note that $bSb^{-1} \subset S$ as well. Let s be an arbitrary element of S . Then $bsb^{-1} = s'$ for some $s' \in S$, and $s = b^{-1}s'b \in b^{-1}Sb$. It follows that $S \subset b^{-1}Sb$ for all $b \in G$, and, with the reverse inclusion derived above, that $S = b^{-1}Sb$. This motivates the following definition.

Definition 23.2.13 A subgroup N of a group G is called **normal** if $N = g^{-1}Ng$ (equivalently if $Ng = gN$) for all $g \in G$. normal subgroup defined

The preceding argument shows that the set of cosets (no specification is necessary since the right and left cosets coincide) of a normal subgroup forms a group:

⁶The set of cosets of a subgroup is the analog of factor space of a subspace of a vector space (Sect. 2.1.2) and factor algebra of a subalgebra of an algebra (Sect. 3.2.1). We have seen that, while a factor space of any subspace can be turned into a vector space, that is not the case with an algebra: the subalgebra must be an ideal of the algebra. There is a corresponding restriction for the subgroup.

quotient or factor group **Theorem 23.2.14** *If N is a normal subgroup of G , then the collection of all cosets of N , denoted by G/N , is a group, called the **quotient group** or **factor group** of G by N .*

We note that the only subgroup conjugate to a normal subgroup N is N itself (see Example 23.2.2), and that all subgroups of an abelian group are automatically normal.

Example 23.2.15 Let $G = \mathbb{R}^3$ and let S be a plane through the origin as in Example 23.2.11. Since G is abelian, S is automatically normal, and G/S is the set of planes parallel to S . Let $\hat{\mathbf{e}}_n$ be a normal to S . Then it is readily seen that

$$G/S = \{r\hat{\mathbf{e}}_n + S \mid r \in \mathbb{R}\}.$$

We have picked the perpendicular distance between a plane and S (with sign included) to represent that plane. The reader may check that the quotient group G/S is isomorphic to \mathbb{R} . Identifying S with \mathbb{R}^2 , we can write $\mathbb{R}^3/\mathbb{R}^2 \cong \mathbb{R}$. The cancellation of exponents is quite accidental here!

Let $G = \mathbb{Z}$ and $S = \mathbb{Z}m$, the set of multiples of the positive integer m . Since \mathbb{Z} is abelian, $\mathbb{Z}m$ is normal, and $\mathbb{Z}/\mathbb{Z}m$ is indeed a group, a typical element of which looks like $k + m\mathbb{Z}$. By adding (or subtracting) multiples of m to k , and using $mj + m\mathbb{Z} = m\mathbb{Z}$ (see Problem 23.5), we can assume that $0 \leq k < m$. It follows that $\mathbb{Z}/\mathbb{Z}m$ is a finite group. Furthermore,

$$(k_1 + m\mathbb{Z}) + (k_2 + m\mathbb{Z}) = k_1 + k_2 + m\mathbb{Z} = k + m\mathbb{Z},$$

where k is the remainder after enough multiples of m have been subtracted from $k_1 + k_2$. One writes $k_1 + k_2 \equiv k \pmod{m}$. The coset $k + m\mathbb{Z}$ is sometimes denoted by \bar{k} and the quotient group $\mathbb{Z}/\mathbb{Z}m$ by \mathbb{Z}_m :

$$\mathbb{Z}_m = \{\bar{0}, \bar{1}, \bar{2}, \dots, \overline{m-1}\}.$$

\mathbb{Z}_m is a prototype of the finite cyclic groups. It can be shown that every cyclic group of order m is isomorphic to \mathbb{Z}_m a generator of which is $\bar{1}$ (recall that the binary operation is *addition* for \mathbb{Z}_m).

first isomorphism theorem **Theorem 23.2.16** (First isomorphism theorem) *Let G and H be groups and $f : G \rightarrow H$ a homomorphism. Then $\ker f$ is a normal subgroup of G , and $G/\ker f$ is isomorphic to $f(G)$.*

Proof We have already seen that $\ker f$ is a subgroup of G . To show that it is normal, let $g \in G$ and $x \in \ker f$. Then

$$\begin{aligned} f(gxg^{-1}) &= f(g)f(x)f(g^{-1}) = f(g)e_H f(g^{-1}) = f(g)f(g^{-1}) \\ &= f(gg^{-1}) = f(e_G) = e_H. \end{aligned}$$

It follows that $gxg^{-1} \in \ker f$. Therefore, $\ker f$ is normal. We leave it to the reader to show that $\phi : G/\ker f \rightarrow f(G)$ given by $\phi(g[\ker f]) \equiv \phi([\ker f]g) = f(g)$ is an isomorphism.⁷ \square

Example 23.2.17 The special linear group of \mathcal{V} is a normal subgroup of the general linear group of \mathcal{V} . To see this, note that $\det : GL(\mathcal{V}) \rightarrow \mathbb{R}^+$ is a homomorphism whose kernel is $SL(\mathcal{V})$.

Definition 23.2.18 Let $x \in G$. A **conjugate** of x is an element y of G that can be written as $y = gxg^{-1}$ with $g \in G$. The set of all elements of G conjugate to one another is called a **conjugacy class**. The i th conjugacy class is denoted by K_i .

conjugate and
conjugacy class defined

One can check that “ x is conjugate to y ” is an equivalence relation whose classes are the conjugacy classes. In particular, two different conjugacy classes are disjoint. One can also show that each element of the center of a group constitutes a class by itself. In particular, the identity in any group is in a class by itself, and each element of an abelian group forms a (different) class.

Although a normal subgroup N contains the conjugate of each of its elements, N is not a class. The class containing any given element of N will be only a proper subset of N (unless N is trivial). The characteristic feature of a normal subgroup is that it contains the conjugacy classes of all its elements. This is not shared by other subgroups, which, in general, contain only the trivial class of the identity element.

Example 23.2.19 Consider the group $SO(3)$ of rotations in three dimensions. Let us denote a rotation by $R_{\hat{e}}(\theta)$, where \hat{e} is the direction of the axis of rotation and θ is the angle of rotation. A typical member of the conjugacy class of $R_{\hat{e}}(\theta)$ is $RR_{\hat{e}}(\theta)R^{-1}$, where R is some rotation. Let $\hat{e}' = R\hat{e}$ be the vector obtained by applying the rotation R on \hat{e} , and note that

$$RR_{\hat{e}}(\theta)R^{-1}\hat{e}' = RR_{\hat{e}}(\theta)R^{-1}R\hat{e} = RR_{\hat{e}}\hat{e} = R\hat{e} = \hat{e}',$$

where we used the fact that $R_{\hat{e}}\hat{e} = \hat{e}$ because a rotation leaves its axis unchanged. This last statement, applied to the equation above, also shows that $RR_{\hat{e}}(\theta)R^{-1}$ is a rotation about \hat{e}' . Problem 23.18 establishes that the angle of rotation associated with $RR_{\hat{e}}(\theta)R^{-1}$ is θ . We can summarize this as $RR_{\hat{e}}(\theta)R^{-1} = R_{\hat{e}'}(\theta)$.

all rotations having the
same angle belong to
the same conjugacy
class

The result of this example is summarized as follows:

Box 23.2.20 All rotations having the same angle belong to the same conjugacy class of the group of rotations in three dimensions.

⁷Compare this theorem with the set-theoretic result obtained in Chap. 1 where the map $X/\simeq \rightarrow f(X)$ was shown to be bijective if \simeq is the equivalence relation induced by f .

23.2.1 Direct Products

The resolution of a vector space into a direct sum of subspaces was a useful tool in revealing its structure. The same idea can also be helpful in studying groups. Recall that the only vector common to the subspaces of a direct sum is the zero vector. Moreover, any vector of the whole space can be written as the sum of vectors taken from the subspaces of the direct sum. Considering a vector space as a (abelian) group, with zero as the identity and summation as the group operation, leads to the notion of direct product.

internal direct product of groups **Definition 23.2.21** A group G is said to be the **direct product** of two of its subgroups H_1 and H_2 , and we write $G = H_1 \times H_2$, if

1. all elements of H_1 commute with all elements of H_2 ;
2. the group identity is the only element common to both H_1 and H_2 ;
3. every $g \in G$ can be written as $g = h_1 h_2$ with $h_1 \in H_1$ and $h_2 \in H_2$.

It follows from this definition that h_1 and h_2 are unique, and H_1 and H_2 are normal. This kind of direct product is sometimes called **internal**, because the “factors” H_1 and H_2 are chosen from inside the group G itself. The external direct product results when we take two unrelated groups and make a group out of them:

external direct product of groups **Proposition 23.2.22** Let G and H be groups. The Cartesian product $G \times H$ can be given a group structure by

$$(g, h) \star (g', h') \equiv (gg', hh').$$

With this multiplication, $G \times H$ is called the **external direct product** of G and H . Furthermore, $G \cong G \times \{e_H\}$, $H \cong \{e_G\} \times H$, $G \times H \cong H \times G$, and to within these isomorphisms, $G \times H$ is the internal direct product of $G \times \{e_H\}$ and $\{e_G\} \times H$.

The proof is left for the reader.

Historical Notes

Niels Henrik Abel (1802–1829) was the second of seven children, son of a Lutheran minister with a small parish of Norwegian coastal islands. In school he received only average marks at first, but then his mathematics teacher was replaced by a man only seven years older than Abel. Abel’s alcoholic father died in 1820, leaving almost no financial support for his young prodigy, who became responsible for supporting his mother and family. His teacher, Holmboe, recognizing his talent for mathematics, raised money from his colleagues to enable Abel to attend Christiania (modern Oslo) University. He entered the university in 1821, 10 years after the university was founded, and soon proved himself worthy of his teacher’s accolades. His second paper, for example, contained the first example of a solution to an integral equation.

Abel then received a two-year government travel grant and journeyed to Berlin, where he met the prominent mathematician Crelle, who soon launched what was to become the leading German mathematical journal of the nineteenth century, commonly called *Crelle’s Journal*. From the start, Abel contributed important papers to Crelle’s Journal, including a classic paper on power series, the scope of which clearly reflects his desire for stringency. His most important work, also published in that journal, was a lengthy treatment of elliptic functions in which Abel incorporated their inverse functions to show



Niels Henrik Abel
1802–1829

that they are a natural generalization of the trigonometric functions. In later research in this area, Abel found himself in stiff competition with another young mathematician, K.G.J. Jacobi. Abel published some papers on functional equations and integrals in 1823. In it he gives the first solution of an integral equation. In 1824 he proved the impossibility of solving algebraically the general equation of the fifth degree and published it at his own expense hoping to obtain recognition for his work.

Despite his proven intellectual success, Abel never achieved material success, not even a permanent academic position. In December of 1828, while traveling by sled to visit his fiancé for Christmas, Abel became seriously ill and died a couple of months later. Ironically, his death from tuberculosis occurred two days before Crelle wrote with the happy news of an appointment for Abel at a scientific institute in Berlin. In Abel’s eulogy in his journal, Crelle wrote:

“He distinguished himself equally by the purity and nobility of his character and by a rare modesty which made his person cherished to the same degree as was his genius.”

23.3 Group Action

The transformation groups introduced at the beginning of this chapter can be described in the language of abstract groups.

Definition 23.3.1 Let G be a group and M a set. The **left action** of G on M is a map $\Phi : G \times M \rightarrow M$ such that

left action, right action,
left invariance and right
invariance

1. $\Phi(e, m) = m$ for all $m \in M$;
2. $\Phi(g_1 g_2, m) = \Phi(g_1, \Phi(g_2, m))$.

One usually denotes $\Phi(g, m)$ by $g \cdot m$ or more simply by gm . The **right action** is defined similarly. A subset $N \subset M$ is called **left (right) invariant** if $g \cdot m \in N$ ($m \cdot g \in N$) for all $g \in G$, whenever $m \in N$.

Example 23.3.2 If we define $f_g : M \rightarrow M$ by $f_g(m) \equiv \Phi(g, m) = g \cdot m$, then f_g is recognized as a transformation of M . The collection of such transformations is a *subgroup* of the set of all transformations of M . Indeed, the identity transformation is simply f_e , the inverse of f_g is $f_{g^{-1}}$, and the (associative) law of composition is $f_{g_1} \circ f_{g_2} = f_{g_1 g_2}$. There is a general theorem in group theory stating that any group is isomorphic to a subgroup of the group of transformations of an appropriate set.

any group is isomorphic
to a subgroup of the
group of transformations
of an appropriate set

Definition 23.3.3 Let G act on M and let $m \in M$. The **orbit** of m , denoted by Gm , is

orbit, stabilizer; transitive
action and effective
action

$$Gm = \{x \in M \mid x = gm \text{ for some } g \in G\}.$$

The action is called **transitive** if $Gm = M$. The **stabilizer** of m is $G_m = \{g \in G \mid gm = m\}$. The group action is called **free** if $G_m = \{e\}$ for all $m \in M$; it is called **effective** if $gm = m$ for all $m \in M$ implies that $g = e$.

The reader may verify that the orbit Gm is the smallest invariant subset of M containing m , and that

Stabilizer is a subgroup.

Box 23.3.4 *The stabilizer of m is a subgroup of G , which is sometimes called the **little group** of G at m .*

Remark 23.3.1 Think of the action of G on M as passing from one point of M to another. An element g of G “transits” a region of M to take $m \in M$ to $gm \in M$. The action is therefore, transitive, if G can transit (pass across) all of M , i.e., G can connect any two points of M .

Help with understanding the terminology of the definition above.

If you think of G_m as those elements of G that are confined to (stuck, or imprisoned at) m , then a “free” action of G does not allow any point of M to imprison any subset of G .

Any $g \in G$ such that $gm = m$ for all $m \in M$ has no “effect” on M . Therefore, this g is “ineffective” in its action on M . For G to act “effectively”, it should not have any “ineffective” member.

A transitive action is characterized by the fact that given any two points $m_1, m_2 \in M$, one can find a $g \in G$ such that $m_2 = gm_1$. In general, there may be several g s connecting m_1 to m_2 . If there are $g, g' \in G$ such that $m_2 = gm_1 = g'm_1$, then

$$gm_1 = g'm_1 \Rightarrow m_1 = g^{-1}g'm_1.$$

If we want g to be unique for all m_1 and m_2 , then the group action must be free.

By definition, the orbits of a group G in M are disjoint and their union is the entire M . Another way of stating the same thing is to say that G partitions M into orbits. It should be obvious that the action of G on any orbit is transitive.

From the remarks above, we conclude that

Box 23.3.5 *Two points of an orbit are connected by a unique element of G iff G acts freely on the orbit.*

Example 23.3.6 Let $M = \mathbb{R}^2$ and $G = SO(2)$, the planar rotation group. The action is rotation of a point in the plane about the origin by an angle θ . The orbits are circles centered at the origin. The action is effective but not transitive. The stabilizer of every point in the plane is $\{e\}$, except the origin, for which the whole group is the stabilizer. Since the stabilizer at the origin is not $\{e\}$, the group action is not free.

Let $M = S^1$, the unit circle, and $G = SO(2)$, the rotation group in two dimensions. The action is displacement of a point on the circle. There is only one orbit, the entire circle. The action is effective and transitive. The stabilizer of every point on the circle is $\{e\}$; therefore, the action is free as well.

Let $M = G$, a group, and let a (proper) subgroup H act on G by left multiplication. The orbits are right cosets Hg of the subgroup. The action is effective but not transitive. The stabilizer of every point in the group is $\{e\}$; hence the action is free.

Let $M = \mathbb{R} \cup \{\infty\}$, the set of real numbers including “the point at infinity”. Define an action of $SL(2, \mathbb{R})$ on M by

$$g \cdot x \equiv \begin{pmatrix} a & b \\ c & d \end{pmatrix} \cdot x = \frac{ax + c}{bx + d}.$$

This is a group action with a law of multiplication identical to the matrix multiplication. The action is transitive, but neither effective nor free. Indeed, the reader is urged to show that

$$g \cdot x = \begin{pmatrix} a & b \\ c & d \end{pmatrix} \cdot x = x \quad \forall x \quad \text{iff} \quad g = \begin{pmatrix} 1 & 0 \\ 0 & 1 \end{pmatrix} \quad \text{or} \quad g = \begin{pmatrix} -1 & 0 \\ 0 & -1 \end{pmatrix}$$

making the group action not effective. Furthermore, for every $x \in M$

$$G_x = \begin{pmatrix} a & b \\ bx^2 + (d - a)x & d \end{pmatrix}$$

making the group action not free.

Let M be a set and H the group of transformations of M . Suppose that there is a homomorphism $f : G \rightarrow H$ from a group G into H . Then there is a natural action of G on M given by $g \cdot m \equiv [f(g)](m)$. The homomorphism f is sometimes called a **realization** of G .

23.4 The Symmetric Group S_n

Because of its primary importance as the prototypical finite group, and because of its significance in quantum statistics, the symmetric (or permutation) group is briefly discussed in this section. It is also used extensively in the theory of representation of the general linear group and its subgroups.

A generic permutation π of n numbers is shown as

$$\pi = \begin{pmatrix} 1 & 2 & \dots & i & \dots & n \\ \pi(1) & \pi(2) & \dots & \pi(i) & \dots & \pi(n) \end{pmatrix}. \quad (23.1)$$

Because the mapping is bijective, no two elements can have the same image, and $\pi(1), \pi(2), \dots, \pi(n)$ exhaust all the elements in the set $\{i\}_{i=1}^n$.

We can display the product $\pi_2 \circ \pi_1$ of two permutations using $\pi_2 \circ \pi_1(i) \equiv \pi_2(\pi_1(i))$. For instance, if

$$\pi_1 = \begin{pmatrix} 1 & 2 & 3 & 4 \\ 3 & 4 & 1 & 2 \end{pmatrix} \quad \text{and} \quad \pi_2 = \begin{pmatrix} 1 & 2 & 3 & 4 \\ 2 & 4 & 3 & 1 \end{pmatrix}, \quad (23.2)$$

Table 23.1 Group multiplication table for S_3

| e | π_2 | π_3 | π_4 | π_5 | π_6 |
|---------|---------|---------|---------|---------|---------|
| π_2 | e | π_5 | π_6 | π_3 | π_4 |
| π_3 | π_6 | e | π_5 | π_4 | π_2 |
| π_4 | π_5 | π_6 | e | π_2 | π_3 |
| π_5 | π_4 | π_2 | π_3 | π_6 | e |
| π_6 | π_3 | π_4 | π_2 | e | π_5 |

then the product $\pi_2 \circ \pi_1$ takes 1 to 3, etc., because $\pi_2 \circ \pi_1(1) \equiv \pi_2(\pi_1(1)) = \pi_2(3) = 3$, etc. We display $\pi_2 \circ \pi_1$ as

$$\pi_2 \circ \pi_1 = \begin{pmatrix} 1 & 2 & 3 & 4 \\ 3 & 1 & 2 & 4 \end{pmatrix}.$$

Example 23.4.1 Let us construct the multiplication table for S_3 . Denote the elements of S_3 as follows:

$$e = \begin{pmatrix} 1 & 2 & 3 \\ 1 & 2 & 3 \end{pmatrix}, \quad \pi_2 = \begin{pmatrix} 1 & 2 & 3 \\ 2 & 1 & 3 \end{pmatrix}, \quad \pi_3 = \begin{pmatrix} 1 & 2 & 3 \\ 3 & 2 & 1 \end{pmatrix},$$

$$\pi_4 = \begin{pmatrix} 1 & 2 & 3 \\ 1 & 3 & 2 \end{pmatrix}, \quad \pi_5 = \begin{pmatrix} 1 & 2 & 3 \\ 3 & 1 & 2 \end{pmatrix}, \quad \pi_6 = \begin{pmatrix} 1 & 2 & 3 \\ 2 & 3 & 1 \end{pmatrix}.$$

We give only one sample evaluation of the entries and leave the straightforward—but instructive—calculation of the other entries to the reader. Consider $\pi_4 \circ \pi_5$, and note that $\pi_5(1) = 3$ and $\pi_4(3) = 2$; so $\pi_4 \circ \pi_5(1) = 2$. Similarly, $\pi_4 \circ \pi_5(2) = 1$ and $\pi_4 \circ \pi_5(3) = 3$. Thus

$$\pi_4 \circ \pi_5 = \begin{pmatrix} 1 & 2 & 3 \\ 2 & 1 & 3 \end{pmatrix} = \pi_2.$$

The entire multiplication table is given in Table 23.1.

Note that both the rows and columns of the group multiplication table include all elements of the group, and no element is repeated in a row or a column. This is because left-multiplication of elements of a group by a single fixed element of the group simply permutes the group elements. Stated differently, the left multiplication map $L_g : G \rightarrow G$, given by $L_g(x) = gx$, is bijective, as the reader may verify.

Because we are dealing with finite numbers, repeated application of a permutation to an integer in the set $\{i\}_{i=1}^n$ eventually produces the initial integer. This leads to the following definition.

cycles of symmetric group **Definition 23.4.2** Let $\pi \in S_n$, $i \in \{1, 2, \dots, n\}$, and let r be the smallest positive integer such that $\pi^r(i) = i$. Then the set of r distinct elements $\{\pi^k(i)\}_{k=0}^{r-1}$ is called a **cycle** of π of length r or an **r -cycle** generated by i .

Start with 1 and apply π to it repeatedly until you obtain 1 again. The collection of elements so obtained forms a cycle in which 1 is contained. Then we select a second number that is not in this cycle and apply π to it repeat-

edly until the original number is obtained again. Continuing in this way, we produce a set of disjoint cycles that exhausts all elements of $\{1, 2, \dots, n\}$.

Proposition 23.4.3 *Any permutation can be broken up into disjoint cycles.*

It is customary to write elements of each cycle in some specific order within parentheses starting with the first element, say i , on the left, then $\pi(i)$ immediately to its right, followed by $\pi^2(i)$, and so on. For example, the permutations π_1 and π_2 of Eq. (23.2) and their product have the cycle structures $\pi_1 = (13)(24)$, $\pi_2 = (124)(3)$, and $\pi_2 \circ \pi_1 = (132)(4)$, respectively.

Example 23.4.4 Let $\pi_1, \pi_2 \in S_8$ be given by

$$\pi_1 = \begin{pmatrix} 1 & 2 & 3 & 4 & 5 & 6 & 7 & 8 \\ 3 & 5 & 7 & 1 & 2 & 8 & 4 & 6 \end{pmatrix},$$

$$\pi_2 = \begin{pmatrix} 1 & 2 & 3 & 4 & 5 & 6 & 7 & 8 \\ 2 & 5 & 6 & 8 & 1 & 7 & 4 & 3 \end{pmatrix}.$$

The reader may verify that

$$\pi_2 \circ \pi_1 = \begin{pmatrix} 1 & 2 & 3 & 4 & 5 & 6 & 7 & 8 \\ 6 & 1 & 4 & 2 & 5 & 3 & 8 & 7 \end{pmatrix}$$

and that

$$\pi_1 = (1374)(25)(68), \quad \pi_2 = (125)(36748),$$

$$\pi_2 \circ \pi_1 = (16342)(5)(78).$$

In general, permutations do not commute. The product in reverse order is

$$\pi_1 \circ \pi_2 = \begin{pmatrix} 1 & 2 & 3 & 4 & 5 & 6 & 7 & 8 \\ 5 & 2 & 8 & 6 & 3 & 4 & 1 & 7 \end{pmatrix} = (15387)(2)(46),$$

which differs from $\pi_2 \circ \pi_1$. However, note that it has the same cycle structure as $\pi_2 \circ \pi_1$, in that cycles of equal length appear in both. This is a general property of all permutations.

Definition 23.4.5 If $\pi \in S_n$ has a cycle of length r and all other cycles of length 1, then π is called a **cyclic permutation** of length r . cyclic permutations defined

It follows that $\pi_2 \in S_4$ as defined earlier is a cyclic permutation of length 3. Similarly,

$$\pi = \begin{pmatrix} 1 & 2 & 3 & 4 & 5 & 6 \\ 6 & 2 & 1 & 3 & 5 & 4 \end{pmatrix}$$

is a cyclic permutation of length 4 (verify this).

Definition 23.4.6 A cyclic permutation of length 2 is called a **transposition**. transpositions defined

A transposition (ij) simply switches i and j .

Example 23.4.7 Products of (not necessarily disjoint) cycles may be associated with a permutation whose action on i is obtained by starting with the first cycle (at the extreme right), locating the first occurrence of i , and keeping track of what each cycle does to it or its image under the preceding cycle. For example, let $\pi_1 \in S_6$ be given as a product of cycles by $\pi_1 = (143)(24)(456)$. To find the permutation, we start with 1 and follow the action of the cycles on it, starting from the right. The first and second cycles leave 1 alone, and the last cycle takes it to 4. Thus, $\pi_1(1) = 4$. For 2 we note that the first cycle leaves it alone, the second cycle takes it to 4, and the last cycle takes 4 to 3. Thus, $\pi_1(2) = 3$. Similarly, $\pi_1(3) = 1$, $\pi_1(4) = 5$, $\pi_1(5) = 6$, and $\pi_1(6) = 2$. Therefore,

$$\pi_1 = \begin{pmatrix} 1 & 2 & 3 & 4 & 5 & 6 \\ 4 & 3 & 1 & 5 & 6 & 2 \end{pmatrix}.$$

We note that π_1 is a cyclic permutation of length 6.

It is left to the reader to show that the permutation $\pi_2 \in S_5$ given by the product $\pi_2 = (13)(15)(12)(14)$ is cyclic: $\pi_2 = (14253)$.

The square of any transposition is the identity. Therefore, we can include it in any product of permutations without changing anything.

Proposition 23.4.8 An r -cycle (i_1, i_2, \dots, i_r) can be decomposed into the product of $r - 1$ transpositions:

$$(i_1, i_2, \dots, i_r) = (i_1 i_r)(i_1 i_{r-1}) \cdots (i_1 i_3)(i_1 i_2).$$

Proof The proof involves keeping track of what happens to each symbol when acted upon by the RHS and the LHS and showing that the two give the same result. This is left as an exercise for the reader. \square

Although the decomposition of Proposition 23.4.8 is not unique, it can be shown that the **parity** of the decomposition (whether the number of factors is even or odd) is unique. For instance, it is easy to verify that

parity of a permutation defined

$$(1234) = (14)(13)(12) = (14) \underbrace{(34)(34)}_1 \underbrace{(23)(12)(12)(23)}_1 (13)(12).$$

That is, (1234) is written as a product of 3 or 9 transpositions, both of which are odd.

We have already seen that any permutation can be written as a product of cycles. In addition, Proposition 23.4.8 says that these cycles can be further broken down into products of transpositions. This implies the following (see [Rotm 84, p. 38]):

parity of a permutation is unique

Proposition 23.4.9 Any permutation can be decomposed as a product of transpositions. The parity of the decomposition is unique.

Definition 23.4.10 A permutation is **even (odd)** if it can be expressed as a product of an even (odd) number of transpositions. even and odd permutations

The parity of a permutation can be determined from its cycle structure and Proposition 23.4.8.

The reader may verify that the mapping from S_n to the multiplicative group of $\{+1, -1\}$ that assigns $+1$ to even permutations and -1 to odd permutations is a group homomorphism. It follows from the first isomorphism theorem (Theorem 23.2.16) that

Box 23.4.11 *The set of even permutations, denoted by A_n , forms a normal subgroup of S_n .*

This homomorphism is usually denoted by ϵ . We therefore define

$$\epsilon(\pi) \equiv \epsilon_\pi = \begin{cases} +1 & \text{if } \pi \text{ is even,} \\ -1 & \text{if } \pi \text{ is odd.} \end{cases} \tag{23.3}$$

Sometimes $\delta(\pi)$ or δ_π as well as $\text{sgn}(\pi)$ is also used. The symbol, $\epsilon_{i_1 i_2 \dots i_n}$ used in the definition of determinants, is closely related to $\epsilon(\pi)$. In fact,

$$\epsilon_{\pi(1)\pi(2)\dots\pi(n)} \equiv \epsilon_\pi.$$

Suppose $\pi, \sigma \in S_n$, and note that⁸ $\sigma(i) \xrightarrow{\sigma^{-1}} i \xrightarrow{\pi} \pi(i) \xrightarrow{\sigma} \sigma \circ \pi(i)$, i.e., the composite $\sigma \circ \pi \circ \sigma^{-1}$ of the three permutations takes $\sigma(i)$ to $\sigma \circ \pi(i)$. This composite can be thought of as the permutation obtained by applying σ to the two rows of $\pi = \begin{pmatrix} 1 & 2 & \dots & n \\ \pi(1) & \pi(2) & \dots & \pi(n) \end{pmatrix}$:

$$\sigma \circ \pi \circ \sigma^{-1} = \begin{pmatrix} \sigma(1) & \sigma(2) & \dots & \sigma(n) \\ \sigma \circ \pi(1) & \sigma \circ \pi(2) & \dots & \sigma \circ \pi(n) \end{pmatrix}.$$

In particular, the cycles of $\sigma \circ \pi \circ \sigma^{-1}$ are obtained by applying σ to the symbols in the cycles of π . Since σ is bijective, the cycles so obtained will remain disjoint. It follows that $\sigma \circ \pi \circ \sigma^{-1}$, a conjugate of π , has the same cycle structure as π itself. In fact, we have the following:

Theorem 23.4.12 *Two permutations are conjugate if and only if they have the same cycle structure.*

To find the distinct conjugacy classes of S_n , one has to construct distinct cycle structures of S_n . This in turn is equivalent to partitioning the numbers from 1 to n into sets of various lengths. Let ν_k be the number of k -cycles in a permutation. The cycle structure of this permutation is denoted

⁸Recall from Chap. 1 that $x \xrightarrow{f} y$ means $y = f(x)$.

by $(1^{v_1}, 2^{v_2}, \dots, n^{v_n})$. Since the total number of symbols is n , we must have $\sum_{k=1}^n k v_k = n$. Defining $\lambda_j \equiv \sum_{k=j}^n v_k$, we have

$$\lambda_1 + \lambda_2 + \dots + \lambda_n = n, \quad \lambda_1 \geq \lambda_2 \geq \dots \geq \lambda_n \geq 0. \quad (23.4)$$

The splitting of n into nonnegative integers $(\lambda_1, \lambda_2, \dots, \lambda_n)$ as in Eq. (23.4) is called a **partition of n** . There is a 1–1 correspondence between partitions of n and the cycle structure of S_n . We saw how v_k 's gave rise to λ 's. Conversely, given a partition of n , we can construct a cycle structure by $v_k = \lambda_k - \lambda_{k+1}$. For example, the partition (32000) of S_5 corresponds to $v_1 = 3 - 2 = 1$, $v_2 = 2 - 0 = 2$, i.e., one 1-cycle and two 2-cycles. One usually omits the zeros and writes (32) instead of (32000). When some of the λ 's are repeated, the number of occurrences is indicated by a power of the corresponding λ ; the partition is then written as $(\mu_1^{n_1}, \mu_2^{n_2}, \dots, \mu_r^{n_r})$, where it is understood that λ_1 through λ_{n_1} have the common value μ_1 , etc. For example, $(3^2 1)$ corresponds to a partition of 7 with $\lambda_1 = 3$, $\lambda_2 = 3$, and $\lambda_3 = 1$. The corresponding cycle structure is $v_1 = 0$, $v_2 = 2$, and $v_3 = 1$, i.e., two 2-cycles and one 3-cycle. The partitions of length 0 are usually ignored. Since $\sum \lambda_i = n$, no confusion will arise as to which symmetric group the partition belongs to. Thus (32000) and (332000) are written as (32) and $(3^2 2)$, and it is clear that (32) belongs to S_5 and $(3^2 2)$ to S_8 .

Example 23.4.13 Let us find the different cycle structures of S_4 . This corresponds to different partitions of 4. We can take $\lambda_1 = 4$ and the rest of the λ 's zero. This gives the partition (4). Next, we let $\lambda_1 = 3$; then λ_2 must be 1, giving the partition (31). With $\lambda_1 = 2$, λ_2 can be either 2 or 1. In the latter case, λ_3 must be 1 as well, and we obtain two partitions, (2^2) and (21^2) . Finally, if $\lambda_1 = 1$, all other nonzero λ 's must be 1 as well (remember that $\lambda_k \geq \lambda_{k+1}$). Therefore, the last partition is of the form (1^4) . We see that there are 5 different partitions of 4. It follows that *there are 5 different conjugacy classes in S_4* .

23.5 Problems

23.1 Let S be a subset of a group G . Show that S is a subgroup if and only if $ab^{-1} \in S$ whenever $a, b \in S$.

23.2 Show that the intersection of two subgroups is a subgroup.

23.3 Let X be a subset of a group G . A **word** on X is an element w of G of the form

$$w = x_1^{e_1} x_2^{e_2} \cdots x_n^{e_n},$$

where $x_i \in X$ and $e_i = \pm 1$. Show that the set of all words on X is a subgroup of G .

23.4 Let $[a, b]$ denote the commutator of a and b . Show that

- (a) $[a, b]^{-1} = [b, a]$,
 (b) $[a, a] = e$ for all $a \in G$, and
 (c) $ab = [a, b]ba$. It is interesting to compare these relations with the familiar commutators of operators.

23.5 Show that if S is a subgroup, then $S^2 \equiv SS = S$, and $tS = S$ if and only if $t \in S$. More generally, $TS = S$ if and only if $T \subset S$.

23.6 Show that if S is a subgroup, then $Sa = Sb$ if and only if $ba^{-1} \in S$ and $ab^{-1} \in S$ ($aS = bS$ if and only if $a^{-1}b \in S$ and $b^{-1}a \in S$).

23.7 Let S be a subgroup of G . Show that $a \triangleright b$ defined by $ab^{-1} \in S$ is an equivalence relation.

23.8 Show that $C_G(x)$ is a subgroup of G . Let H be a subgroup of G and suppose $x \in H$. Show that $C_H(x)$ is a subgroup of $C_G(x)$.

23.9 (a) Show that the only element a in a group with the property $a^2 = a$ is the identity. (b) Now use $e_G \star e_G = e_G$ to show that any homomorphism maps identity to identity. (c) Show that if $f : G \rightarrow H$ is a homomorphism, then $f(g^{-1}) = [f(g)]^{-1}$.

23.10 Establish a bijection between the set of right cosets and the set of left cosets of a subgroup. Hint: Define a map that takes St to $t^{-1}S$.

23.11 Let G be a finite group and S one of its subgroups. Convince yourself that the union of all right cosets of S is G . Now use the fact that distinct right cosets are disjoint and that they have the same cardinality to prove that the order of S divides the order of G . In fact, $|G| = |S||G/S|$, where $|G/S|$ is the number of cosets of S (also called the index of S in G). This is **Lagrange's theorem**.

Lagrange's theorem

23.12 Let $f : G \rightarrow H$ be a homomorphism. Show that $\phi : G/\ker f \rightarrow f(G)$ given by $\phi(g[\ker f]) \equiv \phi([\ker f]g) = f(g)$ is an isomorphism.

23.13 Let G' denote the commutator subgroup of a group G . Show that G' is a *normal* subgroup of G and that G/G' is abelian.

23.14 Let $M = \mathbb{R} \cup \{\infty\}$, and define an action of $SL(2, \mathbb{R})$ on M by

$$\begin{pmatrix} a & b \\ c & d \end{pmatrix} \cdot x = \frac{ax + c}{bx + d}.$$

- (a) Show that this is indeed a group action with a law of multiplication identical to the matrix multiplication.
 (b) Show that the action is transitive.
 (c) Show that beside identity, there is precisely one other element g of the group such that $g \cdot x = x$ for all $x \in M$.

(d) Show that for every $x \in M$,

$$G_x = \begin{pmatrix} a & b \\ bx^2 + (d-a)x & d \end{pmatrix}$$

23.15 Show that two conjugacy classes are either disjoint or identical.

23.16 Show that if all conjugacy classes of a group have only one element, the group must be abelian.

23.17 Consider a map from the conjugacy class of G containing $x \in G$ to the set of (left) cosets $G/C_G(x)$ given by $\phi(axa^{-1}) = aC_G(x)$. Show that ϕ is a bijection. In particular, show that $|C_G(x)| = |G|/|K_x^G|$ where K_x^G is the class in G containing x and $|K_x^G|$ its order (see Problem 23.11). Use this result and Problems 23.8 and 23.11 to show that $|H|/|K_x^H|$ divides $|G|/|K_x^G|$.

23.18 Show that $RR_{\hat{e}}(\theta)R^{-1}$ corresponds to a rotation of angle θ . Hint: Consider the effect of rotation on the vectors in the plane perpendicular to \hat{e} , and note that the rotated plane is perpendicular to $\hat{e}' \equiv R\hat{e}$.

23.19 Let G act on M and let $m_0 \in M$. Show that Gm_0 is the smallest invariant subset of M containing m_0 .

23.20 Suppose G is the direct product of H_1 and H_2 and $g = h_1h_2$. Show that the factors h_1 and h_2 are unique and that H_1 and H_2 are normal.

23.21 Show that $(g, h), (g', h') \in G \times H$ are conjugate if and only if g is conjugate to g' and h is conjugate to h' . Therefore, conjugacy classes of the direct product are obtained by pairing one conjugacy class from each factor.

23.22 Find the products $\pi_1 \circ \pi_2$ and $\pi_2 \circ \pi_1$ of the two permutations

$$\pi_1 = \begin{pmatrix} 1 & 2 & 3 & 4 & 5 & 6 \\ 3 & 4 & 6 & 5 & 1 & 2 \end{pmatrix} \quad \text{and} \quad \pi_2 = \begin{pmatrix} 1 & 2 & 3 & 4 & 5 & 6 \\ 2 & 1 & 3 & 6 & 5 & 4 \end{pmatrix}.$$

23.23 Find the inverses of the permutations

$$\pi_1 = \begin{pmatrix} 1 & 2 & 3 & 4 & 5 & 6 & 7 & 8 \\ 3 & 5 & 7 & 1 & 2 & 8 & 4 & 6 \end{pmatrix},$$

$$\pi_2 = \begin{pmatrix} 1 & 2 & 3 & 4 & 5 & 6 & 7 & 8 \\ 2 & 5 & 6 & 8 & 1 & 7 & 4 & 3 \end{pmatrix}$$

and show directly that $(\pi_1 \circ \pi_2)^{-1} = \pi_2^{-1} \circ \pi_1^{-1}$.

23.24 Find the inverse of each of the following permutations: $\pi_1 = \begin{pmatrix} 1 & 2 & 3 & 4 \\ 3 & 2 & 4 & 1 \end{pmatrix}$, $\pi_2 = \begin{pmatrix} 1 & 2 & 3 & 4 & 5 \\ 1 & 4 & 2 & 5 & 3 \end{pmatrix}$, $\pi_3 = \begin{pmatrix} 1 & 2 & 3 & 4 & 5 & 6 \\ 6 & 5 & 4 & 3 & 2 & 1 \end{pmatrix}$, and $\pi_4 = \begin{pmatrix} 1 & 2 & 3 & 4 & 5 \\ 3 & 4 & 5 & 1 & 2 \end{pmatrix}$.

23.25 Express each of the following products in terms of disjoint cycles. Assume that all permutations are in S_7 .

(a) $(123)(347)(456)(145)$. (b) $(34)(562)(273)$.

(c) $(1345)(134)(13)$.

23.26 Express the following permutations as products of disjoint cycles, and determine which are cyclic.

(a) $\begin{pmatrix} 1 & 2 & 3 & 4 & 5 & 6 \\ 1 & 3 & 4 & 5 & 6 & 2 \end{pmatrix}$, (b) $\begin{pmatrix} 1 & 2 & 3 & 4 & 5 & 6 \\ 2 & 1 & 4 & 5 & 6 & 3 \end{pmatrix}$,

(c) $\begin{pmatrix} 1 & 2 & 3 & 4 & 5 \\ 1 & 3 & 5 & 4 & 2 \end{pmatrix}$.

23.27 Express the permutation $\pi = \begin{pmatrix} 1 & 2 & 3 & 4 & 5 & 6 & 7 & 8 \\ 2 & 4 & 1 & 3 & 6 & 8 & 7 & 5 \end{pmatrix}$ as a product of transpositions. Is the permutation even or odd?

23.28 Express the following permutations as products of transpositions, and determine whether they are even or odd.

(a) $\begin{pmatrix} 1 & 2 & 3 & 4 & 5 \\ 3 & 4 & 2 & 1 & 5 \end{pmatrix}$, (b) $\begin{pmatrix} 1 & 2 & 3 & 4 & 5 & 6 & 7 & 8 \\ 4 & 1 & 7 & 8 & 3 & 6 & 5 & 2 \end{pmatrix}$,

(c) $\begin{pmatrix} 1 & 2 & 3 & 4 & 5 & 6 \\ 6 & 4 & 5 & 3 & 2 & 1 \end{pmatrix}$, (d) $\begin{pmatrix} 1 & 2 & 3 & 4 & 5 & 6 & 7 \\ 6 & 7 & 2 & 4 & 1 & 5 & 3 \end{pmatrix}$.

23.29 Show that the product of two even or two odd permutations is always even, and the product of an even and an odd permutation is always odd.

23.30 Show that π and π^{-1} have the same parity (both even or both odd).

23.31 Find the number of distinct conjugacy classes of S_5 and S_6 .

Group action is extremely important in quantum mechanics. Suppose the Hamiltonian of a quantum system is invariant under a symmetry transformation of its independent parameters such as position, momentum, and time. This invariance will show up as certain properties of the solutions of the Schrödinger equation.

Moreover, the very act of labeling quantum-mechanical states often involves groups and their actions. For example, labeling atomic states by eigenvalues of angular momentum assumes invariance of the Hamiltonian under the action of the rotation group (see Chap. 29) on the Hilbert space of the quantum-mechanical system under consideration.

24.1 Definitions and Examples

In the language of group theory, we have the following situation. Put all the parameters x_1, \dots, x_p of the Hamiltonian \mathbf{H} together to form a space, say \mathbb{R}^p , and write $\mathbf{H} = \mathbf{H}(x_1, \dots, x_p) \equiv \mathbf{H}(\mathbf{x})$. A **group of symmetry** of \mathbf{H} is a group G whose action on \mathbb{R}^p leaves \mathbf{H} unchanged,¹ i.e., $\mathbf{H}(\mathbf{x} \cdot g) = \mathbf{H}(\mathbf{x})$. For example, a one-dimensional harmonic oscillator, with $\mathbf{H} = -\frac{\hbar^2}{2m} \frac{d^2}{dx^2} + \frac{1}{2}m\omega^2 x^2$, has, among other things, parity P (defined by $Px = -x$) as a symmetry. Thus, the group $G = \{e, P\}$ is a group of symmetry of \mathbf{H} .

The Hamiltonian \mathbf{H} of a quantum-mechanical system is an operator in a Hilbert space, such as $\mathcal{L}^2(\mathbb{R}^3)$, the space of square-integrable functions. The important question is: What is the proper way of transporting the action of G from \mathbb{R}^p to $\mathcal{L}^2(\mathbb{R}^3)$? This is a relevant question because the solutions of the Schrödinger equation are, in general, functions of the parameters of the Hamiltonian, and as such will be affected by the symmetry operation on the Hamiltonian. The answer is provided in the following definition.²

¹It will become clear shortly that the appropriate direction for the action is from the right.

²We have already encountered the notion of representation in the context of algebras. Groups are much more widely used in physics than algebras, and group representations have a wider application in physics than their algebraic counterparts. Since some readers may have skipped the section on the representation of algebras, we'll reintroduce the ideas here at the risk of being redundant.

representation; carrier space and dimension of a representation; faithful and identity representation

Definition 24.1.1 Let G be a group and \mathcal{H} a Hilbert space. A **representation of G on \mathcal{H}** is a homomorphism $T : G \rightarrow GL(\mathcal{H})$. The representation is **faithful** if the homomorphism is 1–1. We often denote $T(g)$ by \mathbf{T}_g . \mathcal{H} is called the **carrier space of T** . The trivial homomorphism $T : G \rightarrow \{\mathbf{1}\}$ is also called the **identity representation**. The dimension of \mathcal{H} is called the **dimension of the representation T** .

We do not want to distinguish between representations that differ only by isomorphic vector spaces, because otherwise we can generate an infinite set of representations that are trivially related to one another. A *vector space* isomorphism $f : \mathcal{H} \rightarrow \mathcal{H}'$ induces a *group* isomorphism $\phi : GL(\mathcal{H}) \rightarrow GL(\mathcal{H}')$ defined by

$$\phi(\mathbf{T}) = f \circ \mathbf{T} \circ f^{-1} \quad \text{for } \mathbf{T} \in GL(\mathcal{H}).$$

This motivates the following definition.

equivalent representations

Definition 24.1.2 Two representations $T : G \rightarrow GL(\mathcal{H})$ and $T' : G \rightarrow GL(\mathcal{H}')$ are called **equivalent** if there exists an isomorphism $f : \mathcal{H} \rightarrow \mathcal{H}'$ such that $\mathbf{T}'_g = f \circ \mathbf{T}_g \circ f^{-1}$ for all $g \in G$.

Box 24.1.3 Any representation $T : G \rightarrow GL(\mathcal{H})$ defines an action of the group G on the Hilbert space \mathcal{H} by $\Phi(g, |a\rangle) \equiv \mathbf{T}_g |a\rangle$.

As we saw in Chaps. 4 and 5, the transformation of an operator \mathbf{A} under \mathbf{T}_g would have to be defined by $\mathbf{T}_g \mathbf{A} (\mathbf{T}_g)^{-1}$. For a Hamiltonian with a group of symmetry G , this leads to the identity

$$\mathbf{T}_g [\mathbf{H}(\mathbf{x})] (\mathbf{T}_g)^{-1} = \mathbf{H}(\mathbf{x} \cdot g).$$

Similarly, the action of the group on a vector (function) in $\mathcal{L}^2(\mathbb{R}^3)$ is defined by

$$(\mathbf{T}_g \psi)(\mathbf{x}) \equiv \psi(\mathbf{x} \cdot g), \quad (24.1)$$

where the parentheses around $\mathbf{T}_g \psi$ designate it as a *new* function. One can show that if G acts on the independent variables of a function *on the right* as in Eq. (24.1), then the vector space of such functions is the carrier space of a representation of G . In fact,

$$(\mathbf{T}_{g_1 g_2} \psi)(\mathbf{x}) \equiv \psi(\mathbf{x} \cdot (g_1 g_2)) = \psi((\mathbf{x} \cdot g_1) \cdot g_2) = (\mathbf{T}_{g_2} \psi)(\mathbf{x} \cdot g_1) \equiv \varphi(\mathbf{x} \cdot g_1),$$

where we have defined the new function φ by the last equality. Now note that

$$\varphi(\mathbf{x} \cdot g_1) = (\mathbf{T}_{g_1} \varphi)(\mathbf{x}) = (\mathbf{T}_{g_1} (\mathbf{T}_{g_2} \psi))(\mathbf{x}) = (\mathbf{T}_{g_1} \mathbf{T}_{g_2} \psi)(\mathbf{x}).$$

It follows from the last two equations that

$$\mathbf{T}_{g_1 g_2} \psi = \mathbf{T}_{g_1} \mathbf{T}_{g_2} \psi.$$

Since this holds for arbitrary ψ , we must have $\mathbf{T}_{g_1 g_2} = \mathbf{T}_{g_1} \mathbf{T}_{g_2}$, i.e., that T is a representation. When the action of a group is “naturally” from the left, such as the action of a matrix on a column vector, we replace $\mathbf{x} \cdot g$ with $g^{-1} \cdot \mathbf{x}$. The reader can check that $T : G \rightarrow GL(\mathcal{H})$, given by $\mathbf{T}_g \psi(\mathbf{x}) = \psi(g^{-1} \cdot \mathbf{x})$, is indeed a representation.

Example 24.1.4 Let the Hamiltonian of the time-independent Schrödinger equation $\mathbf{H}|\psi\rangle = E|\psi\rangle$ be invariant under the action of a group G . This means that

$$\mathbf{T}_g \mathbf{H} \mathbf{T}_g^{-1} = \mathbf{H} \quad \Rightarrow \quad [\mathbf{H}, \mathbf{T}_g] = \mathbf{0},$$

i.e., that \mathbf{H} and \mathbf{T}_g are simultaneously diagonalizable (Theorem 6.4.18). It follows that we can choose the energy eigenstates to be eigenstates of \mathbf{T}_g as well, and we can label the states not only by the energy “quantum numbers”—eigenvalues of \mathbf{H} —but also by the eigenvalues of \mathbf{T}_g . For example, if the Hamiltonian is invariant under the action of parity P , then we can choose the states to be *even*, corresponding to parity eigenvalue of $+1$, or *odd*, corresponding to parity eigenvalue of -1 . Similarly, if G is the rotation group, then the states can be labeled by the eigenvalues of the rotation operators, which are, as we shall see, equivalent to the angular momentum operators discussed in Chap. 13.

Energy eigenstates can be labeled by eigenvalues of the symmetry operators as well.

In crystallography and solid-state physics, the Hamiltonian of an (infinite) lattice is invariant under translation by an integer multiple of each so-called *primitive lattice translation*, the three noncoplanar vectors that define a primitive cell of the crystal. The preceding argument shows that the energy eigenstates can be taken to be the eigenstates of the translation operator as well.

It is common to choose a basis and represent all \mathbf{T}_g 's in terms of matrices. Then one gets a **matrix representation** of the group G .

matrix representations

Example 24.1.5 Consider the action of the 2D rotation group $SO(2)$ (rotation about the z -axis) on \mathbb{R}^3 :

$$\begin{aligned} x' &= x \cos \theta - y \sin \theta, \\ \mathbf{r}' = R_z(\theta) \mathbf{r} &\Rightarrow y' = x \sin \theta + y \cos \theta, \\ z' &= z. \end{aligned}$$

For a Hilbert space, also choose \mathbb{R}^3 . Define the homomorphism $T : G \rightarrow GL(\mathcal{H})$ to be the identity map, so that $T(R_z(\theta)) \equiv \mathbf{T}_\theta = R_z(\theta)$. The operator \mathbf{T}_θ transforms the standard basis vectors of \mathcal{H} as

$$\begin{aligned} \mathbf{T}_\theta \hat{\mathbf{e}}_1 &= \mathbf{T}_\theta(1, 0, 0) = (\cos \theta, \sin \theta, 0) = \cos \theta \hat{\mathbf{e}}_1 + \sin \theta \hat{\mathbf{e}}_2 + 0 \hat{\mathbf{e}}_3, \\ \mathbf{T}_\theta \hat{\mathbf{e}}_2 &= \mathbf{T}_\theta(0, 1, 0) = (-\sin \theta, \cos \theta, 0) = -\sin \theta \hat{\mathbf{e}}_1 + \cos \theta \hat{\mathbf{e}}_2 + 0 \hat{\mathbf{e}}_3, \\ \mathbf{T}_\theta \hat{\mathbf{e}}_3 &= \mathbf{T}_\theta(0, 0, 1) = (0, 0, 1) = 0 \hat{\mathbf{e}}_1 + 0 \hat{\mathbf{e}}_2 + \hat{\mathbf{e}}_3. \end{aligned}$$

It follows that the *matrix representation* of $SO(2)$ in the standard basis of \mathcal{H} is

$$\mathbf{T}_\theta = \begin{pmatrix} \cos \theta & -\sin \theta & 0 \\ \sin \theta & \cos \theta & 0 \\ 0 & 0 & 1 \end{pmatrix}.$$

Note that $SO(2)$ is an *infinite* group; its cardinality is determined by the “number” of θ 's.

Example 24.1.6 Let S_3 act on \mathbb{R}^3 on the right by shuffling components:

$$(x_1, x_2, x_3) \cdot \pi = (x_{\pi(1)}, x_{\pi(2)}, x_{\pi(3)}), \quad \pi \in S_3.$$

For the carrier space, choose \mathbb{R}^3 as well. Let $T : S_3 \rightarrow GL(\mathbb{R}^3)$ be given as follows: $T(\pi)$ is the matrix that takes the column vector $\mathbf{x} = \begin{pmatrix} x_1 \\ x_2 \\ x_3 \end{pmatrix}$ to $\begin{pmatrix} x_{\pi(1)} \\ x_{\pi(2)} \\ x_{\pi(3)} \end{pmatrix}$. As a specific illustration, consider $\pi = \begin{pmatrix} 1 & 2 & 3 \\ 3 & 1 & 2 \end{pmatrix}$ and write \mathbf{T}_π for $T(\pi)$. Then

$$\mathbf{T}_\pi(\hat{\mathbf{e}}_1) = \mathbf{T}_\pi(1, 0, 0) = (1, 0, 0) \cdot \pi = (0, 1, 0) = \hat{\mathbf{e}}_2,$$

$$\mathbf{T}_\pi(\hat{\mathbf{e}}_2) = \mathbf{T}_\pi(0, 1, 0) = (0, 1, 0) \cdot \pi = (0, 0, 1) = \hat{\mathbf{e}}_3,$$

$$\mathbf{T}_\pi(\hat{\mathbf{e}}_3) = \mathbf{T}_\pi(0, 0, 1) = (0, 0, 1) \cdot \pi = (1, 0, 0) = \hat{\mathbf{e}}_1,$$

which give rise to the matrix

$$\mathbf{T}_\pi = \begin{pmatrix} 0 & 0 & 1 \\ 1 & 0 & 0 \\ 0 & 1 & 0 \end{pmatrix}.$$

The reader may construct the other five matrices of this representation and verify directly that it is indeed a (faithful) representation: Products and inverses of permutations are mapped onto products and inverses of the corresponding matrices.

24.2 Irreducible Representations

The utility of a representation lies in our comfort with the structure of vector spaces. The climax of such comfort is the spectral decomposition theorems of (normal) operators on vector spaces of finite (Chap. 6) and infinite (Chap. 17) dimensions. The operators \mathbf{T}_g , relevant to our present discussion, are, in general, neither normal nor simultaneously commuting. Therefore, the complete diagonalizability of all \mathbf{T}_g 's is out of the question (unless the group happens to be abelian).

The best thing next to complete diagonalization is to see whether there are common *invariant subspaces* of the vector space \mathcal{H} carrying the representation. We already know how to construct (minimal) “invariant” subsets of \mathcal{H} : these are precisely the *orbits* of the action of the group G on \mathcal{H} . The linearity of \mathbf{T}_g 's guarantees that the span of each orbit is actually an invariant subspace, and that such subspaces are the smallest invariant subspaces

containing a given vector. Our aim is to find those *minimal* invariant subspaces whose orthogonal complements are also invariant. We encountered the same situation in Chap. 6 for a single operator.

Definition 24.2.1 A representation $T : G \rightarrow GL(\mathcal{H})$ is called **reducible** if there exist subspaces \mathcal{U} and \mathcal{W} of \mathcal{H} such that $\mathcal{H} = \mathcal{U} \oplus \mathcal{W}$ and both \mathcal{U} and \mathcal{W} are invariant under all \mathbf{T}_g 's. If no such subspaces exist, \mathcal{H} is said to be **irreducible**.

reducible and irreducible representations

In most cases of physical interest, where \mathcal{H} is a Hilbert space, $\mathcal{W} = \mathcal{U}^\perp$. Then, in the language of Definition 6.1.4, a representation is reducible if a proper subspace of \mathcal{H} reduces all \mathbf{T}_g 's.

Example 24.2.2 Let S_3 act on \mathbb{R}^3 as in Example 24.1.6. For the carrier space \mathcal{H} , choose the space of functions on \mathbb{R}^3 , and for T , the homomorphism $T : G \rightarrow GL(\mathcal{H})$, given by $\mathbf{T}_g \psi(\mathbf{x}) = \psi(\mathbf{x} \cdot g)$, for $\psi \in \mathcal{H}$. Any ψ that is symmetric in x, y, z , such as $xyz, x + y + z$, or $x^2 + y^2 + z^2$, defines a one-dimensional invariant subspace of \mathcal{H} . To obtain another invariant subspace, consider $\psi_1(x, y, z) \equiv xy$ and let $\{\pi_i\}_{i=1}^6$ be as given in Example 23.4.1. Then, denoting \mathbf{T}_{π_i} by \mathbf{T}_i , the reader may check that

$$[\mathbf{T}_1 \psi_1](x, y, z) = \psi_1((x, y, z) \cdot \pi_1) = \psi_1(x, y, z) = xy = \psi_1(x, y, z),$$

$$[\mathbf{T}_2 \psi_1](x, y, z) = \psi_1((x, y, z) \cdot \pi_2) = \psi_1(y, x, z) = yx = \psi_1(x, y, z),$$

$$[\mathbf{T}_3 \psi_1](x, y, z) = \psi_1((x, y, z) \cdot \pi_3) = \psi_1(z, y, x) = zy \equiv \psi_2(x, y, z),$$

$$[\mathbf{T}_4 \psi_1](x, y, z) = \psi_1((x, y, z) \cdot \pi_4) = \psi_1(x, z, y) = xz \equiv \psi_3(x, y, z),$$

$$[\mathbf{T}_5 \psi_1](x, y, z) = \psi_1((x, y, z) \cdot \pi_5) = \psi_1(z, x, y) = zx = \psi_3(x, y, z),$$

$$[\mathbf{T}_6 \psi_1](x, y, z) = \psi_1((x, y, z) \cdot \pi_6) = \psi_1(y, z, x) = yz = \psi_2(x, y, z).$$

This is clearly a three-dimensional invariant subspace of \mathcal{H} with ψ_1, ψ_2 , and ψ_3 as a convenient basis, in which the first three permutations are represented by

$$\mathbf{T}_1 = \begin{pmatrix} 1 & 0 & 0 \\ 0 & 1 & 0 \\ 0 & 0 & 1 \end{pmatrix}, \quad \mathbf{T}_2 = \begin{pmatrix} 1 & 0 & 0 \\ 0 & 0 & 1 \\ 0 & 1 & 0 \end{pmatrix}, \quad \mathbf{T}_3 = \begin{pmatrix} 0 & 1 & 0 \\ 1 & 0 & 0 \\ 0 & 0 & 1 \end{pmatrix}.$$

It is instructive for the reader to verify these relations and to find the three remaining matrices.

Example 24.2.3 Let S_3 act on \mathbb{R}^3 as in Example 24.1.6. For the carrier space of representation, choose the subspace \mathcal{V} of the \mathcal{H} of Example 24.2.2 spanned by the six functions x, y, z, xy, xz , and yz . For T , choose the same homomorphism as in Example 24.2.2 restricted to \mathcal{V} . It is clear that the subspaces \mathcal{U} and \mathcal{W} spanned, respectively, by the first three and the last three functions are invariant under S_3 , and that $\mathcal{V} = \mathcal{U} \oplus \mathcal{W}$. It follows that

the representation is reducible. The matrix form of this representation is found to be of the general form $\begin{pmatrix} \mathbf{A} & \mathbf{0} \\ \mathbf{0} & \mathbf{B} \end{pmatrix}$, where \mathbf{B} is one of the 6 matrices of Example 24.2.2. The matrix \mathbf{A} , corresponding to the three functions x , y , and z , can be found similarly.

Let \mathcal{H} be a carrier space, finite- or infinite-dimensional. For any vector $|a\rangle$, the reader may check that the span of $\{\mathbf{T}_g|a\rangle\}_{g \in G}$ is an invariant subspace of \mathcal{H} . If G is finite, this subspace is clearly finite-dimensional. The irreducible subspace containing $|a\rangle$, a subspace of the span of $\{\mathbf{T}_g|a\rangle\}_{g \in G}$, will also be finite-dimensional. Because of the arbitrariness of $|a\rangle$, it follows that every vector of \mathcal{H} lies in an irreducible subspace, and that

Box 24.2.4 *All irreducible representations of a finite group are finite-dimensional.*

Due to the importance and convenience of unitary operators (for example, the fact that they leave the inner product invariant), it is desirable to be able to construct a unitary representation—or a representation that is equivalent to one—of groups. The following theorem ensures that this desire can be realized for finite groups.

All representations are equivalent to unitary representations.

Theorem 24.2.5 *Every representation of a finite group G is equivalent to some unitary representation.*

Proof We present the proof because of its simplicity and elegance. Let T be a representation of G . Consider the positive hermitian operator $\mathbf{T} \equiv \sum_{x \in G} \mathbf{T}_x^\dagger \mathbf{T}_x$ and note that

$$\begin{aligned} \mathbf{T}_g^\dagger \mathbf{T} \mathbf{T}_g &= \sum_{x \in G} [T(g)]^\dagger [T(x)]^\dagger T(x) T(g) \\ &= \sum_{x \in G} [T(xg)]^\dagger T(xg) = \sum_{y \in G} [T(y)]^\dagger T(y) = \mathbf{T}, \end{aligned} \quad (24.2)$$

where we have used the fact that the sum over x and $y \equiv xg$ sweep through the entire group. Now let $\mathbf{S} = \sqrt{\mathbf{T}}$, and multiply both sides of Eq. (24.2)—with \mathbf{S}^2 replacing \mathbf{T} —by \mathbf{S}^{-1} on the left and by $\mathbf{T}_g^{-1} \mathbf{S}^{-1}$ on the right to obtain

$$\mathbf{S}^{-1} \mathbf{T}_g^\dagger \mathbf{S} = \mathbf{S} \mathbf{T}_g^{-1} \mathbf{S}^{-1} \Rightarrow (\mathbf{S} \mathbf{T}_g \mathbf{S}^{-1})^\dagger = (\mathbf{S} \mathbf{T}_g \mathbf{S}^{-1})^{-1} \quad \forall g \in G.$$

This shows that the representation T' defined by $\mathbf{T}'_g \equiv \mathbf{S} \mathbf{T}_g \mathbf{S}^{-1}$ for all $g \in G$ is unitary. \square

There is another convenience afforded by unitary representations:

Theorem 24.2.6 *Let $T : G \rightarrow GL(\mathcal{H})$ be a unitary representation and \mathcal{W} an invariant subspace of \mathcal{H} . Then, \mathcal{W}^\perp is also invariant.*

Proof Suppose $|a\rangle \in \mathcal{W}^\perp$. We need to show that $\mathbf{T}_g|a\rangle \in \mathcal{W}^\perp$ for all $g \in G$. To this end, let $|b\rangle \in \mathcal{W}$. Then

$$\langle b|\mathbf{T}_g|a\rangle = (\langle a|\mathbf{T}_g^\dagger|b\rangle)^* = (\langle a|\mathbf{T}_g^{-1}|b\rangle)^* = (\langle a|\mathbf{T}_{g^{-1}}|b\rangle)^* = 0,$$

because $\mathbf{T}_{g^{-1}}|b\rangle \in \mathcal{W}$. It follows from this equality that $\mathbf{T}_g|a\rangle \in \mathcal{W}^\perp$ for all $g \in G$. \square

The carrier space \mathcal{H} of a unitary representation is either irreducible or has an invariant subspace \mathcal{W} , in which case we have $\mathcal{H} = \mathcal{W} \oplus \mathcal{W}^\perp$, where, by Theorem 24.2.6, \mathcal{W}^\perp is also invariant. If \mathcal{W} and \mathcal{W}^\perp are not irreducible, then they too can be written as direct sums of invariant subspaces. Continuing this process, we can decompose \mathcal{H} into irreducible invariant subspaces $\mathcal{W}^{(k)}$ such that

$$\mathcal{H} = \mathcal{W}^{(1)} \oplus \mathcal{W}^{(2)} \oplus \mathcal{W}^{(3)} \oplus \dots$$

If the carrier space is finite-dimensional, which we assume from now on and for which we use the notation \mathcal{V} , then the above direct sum is finite and we write

$$\mathcal{V} = \mathcal{W}^{(1)} \oplus \mathcal{W}^{(2)} \oplus \dots \oplus \mathcal{W}^{(p)} \equiv \bigoplus_{k=1}^p \mathcal{W}^{(k)}. \quad (24.3)$$

One can think of $\mathcal{W}^{(k)}$ as the carrier space of an (irreducible) representation. The homomorphism $T^{(k)} : G \rightarrow GL(\mathcal{W}^{(k)})$ is simply the restriction of T to the subspace $\mathcal{W}^{(k)}$, and we write

$$\mathbf{T}_g = \mathbf{T}_g^{(1)} \oplus \mathbf{T}_g^{(2)} \oplus \dots \oplus \mathbf{T}_g^{(r)} \equiv \bigoplus_{k=1}^r \mathbf{T}_g^{(k)}.$$

If we identify all equivalent irreducible representations and collect them together, we may rewrite the last equation as

$$\mathbf{T}_g = m_1 \mathbf{T}_g^{(1)} \oplus m_2 \mathbf{T}_g^{(2)} \oplus \dots \oplus m_\rho \mathbf{T}_g^{(\rho)} \equiv \bigoplus_{\alpha=1}^{\rho} m_\alpha \mathbf{T}_g^{(\alpha)}, \quad (24.4)$$

where ρ is the number of *inequivalent* irreducible representations and m_α are positive integers giving the number of times an irreducible representation $\mathbf{T}_g^{(\alpha)}$ and all its equivalents occur in a given representation.

In terms of matrices, \mathbf{T}_g will be represented in a block-diagonal form as

$$\mathbf{T}_g = \begin{pmatrix} \mathbf{T}_g^{(1)} & 0 & \dots & 0 \\ 0 & \mathbf{T}_g^{(2)} & \dots & 0 \\ \vdots & \vdots & & \vdots \\ 0 & 0 & \dots & \mathbf{T}_g^{(r)} \end{pmatrix},$$

or

$$T_g = \begin{pmatrix} [T_g^{(1)}]_{m_1} & 0 & \dots & 0 \\ 0 & [T_g^{(2)}]_{m_2} & \dots & 0 \\ \vdots & \vdots & \dots & \vdots \\ 0 & 0 & \dots & [T_g^{(\rho)}]_{m_\rho} \end{pmatrix},$$

where, in the first matrix some of the $T_g^{(k)}$ may be equivalent, and in the second matrix, $[T_g^{(\alpha)}]_{m_\alpha}$ is a block-diagonal matrix consisting of m_α copies of the matrix $T_g^{(\alpha)}$.

antisymmetric representation of a permutation group

Example 24.2.7 A one-dimensional (and therefore irreducible) representation, defined for all groups, is the **trivial** (symmetric) representation $T : G \rightarrow \mathbb{C}$ given by $T(g) = 1$ for all $g \in G$. For the permutation group S_n , one can define another one-dimensional (thus irreducible) representation $T : S_n \rightarrow \mathbb{C}$, called the **antisymmetric** representation, given by $T(\pi) = +1$ if π is even, and $T(\pi) = -1$ if π is odd.

Given any (matrix) representation T of G , one can form the transpose inverse matrices $(T_g^t)^{-1}$, and complex conjugate matrices T_g^* . The reader may check that each set of these matrices forms a representation of G .

adjoint and complex conjugate representations

Definition 24.2.8 The set of matrices $(T_g^t)^{-1}$ and T_g^* are called, respectively, the **adjoint representation**, denoted by \bar{T} , and the **complex conjugate representation**, denoted by T^* .

24.3 Orthogonality Properties

Homomorphisms preserve group structures. By studying a group that is more attuned to concrete manipulations, we gain insight into the structure of groups that are homomorphic to it. The group of invertible operators on a vector space, especially in their matrix representation, are particularly suited for such a study because of our familiarity with matrices and operators. The last section reduced this study to inequivalent irreducible representations. This section is devoted to a detailed study of such representations.

Schur's lemma

Lemma 24.3.1 (Schur's lemma) *Let $T : G \rightarrow GL(\mathcal{V})$ and $T' : G \rightarrow GL(\mathcal{V}')$ be irreducible representations of G . If $\mathbf{A} \in \mathcal{L}(\mathcal{V}, \mathcal{V}')$ is such that*

$$\mathbf{A}T_g = T'_g\mathbf{A} \quad \forall g \in G, \tag{24.5}$$

then either \mathbf{A} is an isomorphism (i.e., T is equivalent to T'), or $\mathbf{A} = 0$.

Proof Let $|a\rangle \in \ker \mathbf{A}$. Then

$$\mathbf{A}T_g|a\rangle = T'_g\underbrace{\mathbf{A}|a\rangle}_{=0} = 0 \quad \Rightarrow \quad T_g|a\rangle \in \ker \mathbf{A} \quad \forall g \in G.$$

It follows that $\ker \mathbf{A}$, a subspace of \mathcal{V} , is invariant under T . Irreducibility of T implies that either $\ker \mathbf{A} = \mathcal{V}$, or $\ker \mathbf{A} = 0$. The first case asserts that \mathbf{A} is the zero linear transformation; the second case implies that \mathbf{A} is injective.

Similarly, let $|b\rangle \in \mathbf{A}(\mathcal{V})$. Then $|b\rangle = \mathbf{A}|x\rangle$ for some $|x\rangle \in \mathcal{V}$:

$$\mathbf{T}'_g |b\rangle = \mathbf{T}'_g \mathbf{A}|x\rangle = \underbrace{\mathbf{A} \mathbf{T}'_g |x\rangle}_{\in \mathbf{A}(\mathcal{V})} \Rightarrow \mathbf{T}'_g |b\rangle \in \mathbf{A}(\mathcal{V}) \quad \forall g \in G.$$

It follows that $\mathbf{A}(\mathcal{V})$, a subspace of \mathcal{V}' , is invariant under T' . Irreducibility of T' implies that either $\mathbf{A}(\mathcal{V}) = 0$, or $\mathbf{A}(\mathcal{V}) = \mathcal{V}'$. The first case is consistent with the first conclusion drawn above: $\ker \mathbf{A} = \mathcal{V}$. The second case asserts that \mathbf{A} is surjective. Combining the two results, we conclude that \mathbf{A} is either the zero operator or an isomorphism. \square

Lemma 24.3.1 becomes extremely useful when we concentrate on a single irreducible representation, i.e., when $T' = T$.

Lemma 24.3.2 *Let $T : G \rightarrow GL(\mathcal{V})$ be an irreducible representation of G . If $\mathbf{A} \in \mathcal{L}(\mathcal{V})$ is such that $\mathbf{A} \mathbf{T}_g = \mathbf{T}_g \mathbf{A}$ for all $g \in G$, then $\mathbf{A} = \lambda \mathbf{1}$.*

Proof Replacing \mathcal{V}' with \mathcal{V} in Lemma 24.3.1, we conclude that $\mathbf{A} = \mathbf{0}$ or \mathbf{A} is an isomorphism of \mathcal{V} . In the first case, $\lambda = 0$. In the second case, \mathbf{A} must have a nonzero eigenvalue λ and at least one eigenvector (see Theorem 6.2.5). It follows that the operator $\mathbf{A} - \lambda \mathbf{1}$ commutes with all \mathbf{T}_g 's and it is not an isomorphism (why not?). Therefore, it must be the zero operator. \square

We can immediately put this lemma to good use. If G is abelian, all operators $\{\mathbf{T}_x\}_{x \in G}$ commute with one another. Focusing on one of these operators, say \mathbf{T}_g , noting that it commutes with all operators of the representation, and using Lemma 24.3.2, we conclude that $\mathbf{T}_g = \lambda \mathbf{1}$. It follows that when \mathbf{T}_g acts on a vector, it gives a multiple of that vector. Therefore, it leaves any one-dimensional subspace of the carrier space invariant. Since this is true for all $g \in G$, we have the following result.

Theorem 24.3.3 *All irreducible representations of an abelian group are one-dimensional.*

This theorem is an immediate consequence of Schur's lemma, and is independent of the order of G . In particular, it holds for infinite groups, if Schur's lemma holds for those groups. One important class of infinite groups for which Schur's lemma holds is the Lie groups (to be discussed in Part IX). Thus, all abelian Lie groups have 1-dimensional irreducible representations. We shall see later that the converse of Theorem 24.3.3 is also true for finite groups.



Issai Schur 1875–1941

Historical Notes

Issai Schur (1875–1941) was one of the most brilliant mathematicians active in Germany during the first third of the twentieth century. He attended the Gymnasium in Libau (now Liepāja, Latvia) and then the University of Berlin, where he spent most of his scientific career from 1911 until 1916. When he returned to Berlin, he was an assistant professor at Bonn. He became full professor at Berlin in 1919. Schur was forced to retire by the Nazi authorities in 1935 but was able to emigrate to Palestine in 1939. He died there of a heart ailment several years later. Schur had been a member of the Prussian Academy of Sciences before the Nazi purges. He married and had a son and daughter.

Schur's principal field was the representation theory of groups, founded a little before 1900 by his teacher Frobenius. Schur seems to have completed this field shortly before World War I, but he returned to the subject after 1925, when it became important for physics. Further developed by his student Richard Brauer, it is in our time experiencing an extraordinary growth through the opening of new questions. Schur's dissertation (1901) became fundamental to the representation theory of the general linear group; in fact, English mathematicians have named certain of the functions appearing in the work "S-functions" in Schur's honor. In 1905 Schur reestablished the theory of group characters—the keystone of representation theory. The most important tool involved is "Schur's lemma." Along with the representation of groups by integral linear substitutions, Schur was also the first to study representation by linear fractional substitutions, treating this more difficult problem almost completely in two works (1904, 1907). In 1906 Schur considered the fundamental problems that appear when an algebraic number field is taken as the domain; a number appearing in this connection is now called the Schur index. His works written after 1925 include a complete description of the rational and of the continuous representations of the general linear group; the foundations of this work were in his dissertation.

A lively interchange with many colleagues led Schur to contribute important memoirs to other areas of mathematics. Some of these were published as collaborations with other authors, although publications with dual authorship were almost unheard of at that time. Here we simply indicate the areas: pure group theory, matrices, algebraic equations, number theory, divergent series, integral equations, and function theory.

All vectors of each irreducible subspace of the representation of a symmetry of the hamiltonian are eigenstates of the hamiltonian corresponding to a single eigenvalue.

Example 24.3.4 Suppose that the Hamiltonian \mathbf{H} of a quantum mechanical system with Hilbert space \mathcal{H} has a group of symmetry with a representation $T : G \rightarrow GL(\mathcal{H})$. Then $\mathbf{H}\mathbf{T}_g = \mathbf{T}_g\mathbf{H}$ for all $g \in G$. It follows that $\mathbf{H} = \lambda \mathbf{1}$ if the representation is irreducible. Therefore, all vectors of each invariant irreducible subspace are eigenstates of the hamiltonian corresponding to the same eigenvalue, i.e., they all have the same energy. Therefore, the degeneracy of that energy state is at least as large as the dimension of the carrier space.

It is helpful to arrive at the statement above from a different perspective. Consider a vector $|x\rangle$ in the eigenspace \mathcal{M}_i corresponding to the energy eigenvalue E_i . Since \mathbf{T}_g and \mathbf{H} commute, $\mathbf{T}_g|x\rangle$ is also in \mathcal{M}_i . Therefore, an eigenspace of a Hamiltonian with a group of symmetry is invariant under all \mathbf{T}_g for any representation T of that group. If T is one of the irreducible representations of G , say $T^{(\alpha)}$ with dimension n_α , then $\dim \mathcal{M}_i \geq n_\alpha$.

Consider two irreducible representations $T^{(\alpha)}$ and $T^{(\beta)}$ of a group G with carrier spaces $\mathcal{W}^{(\alpha)}$ and $\mathcal{W}^{(\beta)}$, respectively. Let \mathbf{X} be any operator in $\mathcal{L}(\mathcal{W}^{(\alpha)}, \mathcal{W}^{(\beta)})$, and define

$$\mathbf{A} \equiv \sum_{x \in G} \mathbf{T}_x^{(\alpha)} \mathbf{X} \mathbf{T}_{x^{-1}}^{(\beta)} = \sum_{x \in G} T^{(\alpha)}(x) \mathbf{X} T^{(\beta)}(x^{-1}).$$

Then, we have

$$\begin{aligned} \mathbf{T}_g^{(\alpha)} \mathbf{A} &= \sum_{x \in G} T^{(\alpha)}(g) T^{(\alpha)}(x) \mathbf{X} T^{(\beta)}(x^{-1}) T^{(\beta)}(g^{-1}) T^{(\beta)}(g) \\ &= \sum_{x \in G} \underbrace{T^{(\alpha)}(gx) \mathbf{X} T^{(\beta)}((gx)^{-1})}_{=\mathbf{A} \text{ because this sum also covers all } G} T^{(\beta)}(g) = \mathbf{A} \mathbf{T}_g^{(\beta)}. \end{aligned}$$

We are interested in the two cases where $T^{(\alpha)} = T^{(\beta)}$, and where $T^{(\alpha)}$ is not equivalent to $T^{(\beta)}$. In the first case, Lemma 24.3.2 gives $\mathbf{A} = \lambda \mathbf{1}$; in the second case, Lemma 24.3.1 gives $\mathbf{A} = 0$. Combining these two results and labeling the constant multiplying the unit operator by X , we can write

$$\sum_{g \in G} T^{(\alpha)}(g) \mathbf{X} T^{(\beta)}(g^{-1}) = \lambda_X \delta_{\alpha\beta} \mathbf{1}. \tag{24.6}$$

The presence of the completely arbitrary operator \mathbf{X} indicates that Eq. (24.6) is a powerful statement about—and a severe restriction on—the operators $T^{(\alpha)}(g)$. This becomes more transparent if we select a basis, represent all operators by matrices, and for \mathbf{X} , the matrix representation of \mathbf{X} , choose a matrix whose only nonzero element is 1 and occurs at the l th row and m th column. Then Eq. (24.6) becomes

$$\sum_{g \in G} T_{il}^{(\alpha)}(g) T_{mj}^{(\beta)}(g^{-1}) = \lambda_{lm} \delta_{\alpha\beta} \delta_{ij},$$

where λ_{lm} is a constant that can be evaluated by setting $j = i$, $\alpha = \beta$, and summing over i . The RHS will give $\lambda_{lm} \sum_i \delta_{ii} = \lambda_{lm} n_\alpha$, where n_α is the dimension of the carrier space of $T^{(\alpha)}$. For the LHS we get

$$\begin{aligned} \text{LHS} &= \sum_{g \in G} \sum_i T_{il}^{(\alpha)}(g) T_{mi}^{(\alpha)}(g^{-1}) = \sum_{g \in G} (T^{(\alpha)}(g^{-1}) T^{(\alpha)}(g))_{ml} \\ &= \sum_{g \in G} T_{ml}^{(\alpha)}(g^{-1}g) = \sum_{g \in G} \underbrace{T_{ml}^{(\alpha)}(e)}_{=(1)_{ml}} = |G| \delta_{ml}, \end{aligned}$$

where $|G|$ is the order of the group. Putting everything together, we obtain

$$\sum_{g \in G} T_{il}^{(\alpha)}(g) T_{mj}^{(\beta)}(g^{-1}) = \frac{|G|}{n_\alpha} \delta_{ml} \delta_{\alpha\beta} \delta_{ij}. \tag{24.7}$$

If the representation is unitary, then

$$\sum_{g \in G} T_{il}^{(\alpha)}(g) T_{jm}^{(\beta)*}(g) = \frac{|G|}{n_\alpha} \delta_{ml} \delta_{\alpha\beta} \delta_{ij}. \tag{24.8}$$

Equations (24.7) and (24.8) depend on the basis chosen in which to express matrices. To eliminate this dependence, we first introduce the important concept of character.

character of a representation; simple character, compound character

Definition 24.3.5 Let $T : G \rightarrow GL(\mathcal{V})$ be a representation of the group G . The **character** of this representation is the map $\chi : G \rightarrow \mathbb{C}$ given by

$$\chi(g) \equiv \text{tr } \mathbf{T}_g = \sum_i \mathbf{T}_{ii}(g),$$

where $\mathbf{T}(g)$ is the matrix representation of \mathbf{T}_g in any basis of \mathcal{V} . If T is irreducible, the character is called **simple**; otherwise, it is called **compound**.

The character of the identity element in any representation can be calculated immediately. Since a homomorphism maps identity onto identity, $\mathbf{T}_e = \mathbf{1}$. Therefore,

$$\chi(e) = \text{tr}(\mathbf{1}) = \dim \mathcal{V}. \tag{24.9}$$

Recall that two elements $x, y \in G$ belong to the same conjugacy class if there exist $g \in G$ such that $x = gyg^{-1}$. This same relation holds for the operators representing the elements: $\mathbf{T}_x = \mathbf{T}_g \mathbf{T}_y \mathbf{T}_g^{-1}$. Taking the trace of both sides, and noting that $\mathbf{T}_{g^{-1}} = \mathbf{T}_g^{-1}$, one obtains

Box 24.3.6 All elements of a group belonging to the same conjugacy class have the same character.

Setting $i = l$ and $j = m$ in (24.7) and summing over i and j , we obtain

$$\begin{aligned} \sum_{g \in G} \chi^{(\alpha)}(g) \chi^{(\beta)}(g^{-1}) &= \frac{|G|}{n_\alpha} \delta_{\alpha\beta} \sum_{i,j} \delta_{ji} \delta_{ij} = \frac{|G|}{n_\alpha} \delta_{\alpha\beta} \underbrace{\sum_j \delta_{jj}}_{=n_\alpha} = |G| \delta_{\alpha\beta}. \end{aligned} \tag{24.10}$$

If the representation is unitary, then (24.8) gives

$$\sum_{g \in G} \chi^{(\alpha)}(g) \chi^{(\beta)*}(g) = |G| \delta_{\alpha\beta}. \tag{24.11}$$

This equation suggests a useful interpretation: Characters can be thought of as vectors in a $|G|$ -dimensional inner product space. According to Eq. (24.11), the characters of inequivalent irreducible representations are orthogonal. In particular, since there cannot be more orthogonal vectors than the dimension of a vector space, we conclude that the number of irreducible inequivalent representations of a group cannot be more than the cardinality of that group. Actually, we can do better. Restricting ourselves to unitary representations and collecting all elements belonging to the same conjugacy class together, we write

$$\sum_{i=1}^r c_i \chi_i^{(\alpha)} \chi_i^{(\beta)*} = |G| \delta_{\alpha\beta} \Rightarrow \langle \chi^{(\beta)} | \chi^{(\alpha)} \rangle = |G| \delta_{\alpha\beta}, \tag{24.12}$$

where i labels conjugacy classes, c_i is the number of elements in the i th class, r is the number of classes in G , and $|\chi^{(\alpha)}\rangle \in \mathbb{C}^r$ is an r -dimensional vector with components $\{c_i^{1/2} \chi_i^{(\alpha)}\}_{i=1}^r$. Equation (24.12) shows that vectors belonging to different irreducible representations are orthogonal. Since there cannot be more orthogonal vectors than the dimension of a vector space, we conclude that

Proposition 24.3.7 *The number of inequivalent irreducible representations of a group cannot be more than the number of conjugacy classes of the group, i.e., $\rho \leq r$.*

The characters of the adjoint representation are obtained from

$$\bar{\chi}(g) = \chi(g^{-1}) \Rightarrow \bar{\chi}_i = \chi_{i'},$$

where $K_{i'}$ is the class consisting of all elements inverse to those of the class K_i . The equations involving characters of inverses of group elements can be written in terms of the characters of the adjoint representation. For example, Eq. (24.10) becomes

$$\sum_{g \in G} \chi^{(\alpha)}(g) \bar{\chi}^{(\beta)}(g) = |G| \delta_{\alpha\beta} \Rightarrow \sum_{i=1}^r c_i \chi_i^{(\alpha)} \bar{\chi}_i^{(\beta)} = |G| \delta_{\alpha\beta}. \quad (24.13)$$

Other relations can be obtained similarly.

24.4 Analysis of Representations

We can use the results obtained in the last section to gain insight into a given representation. Take the trace of both sides of Eq. (24.4) and write the result as

$$\chi(g) = m_1 \chi^{(1)}(g) + \cdots + m_\rho \chi^{(\rho)}(g) \equiv \sum_{\alpha=1}^{\rho} m_\alpha \chi^{(\alpha)}(g); \quad (24.14)$$

i.e., a compound character is a linear combination of simple characters *with nonnegative integer coefficients*. Furthermore, the orthogonality of simple characters gives

$$m_\alpha = \frac{1}{|G|} \sum_{g \in G} \chi(g) \chi^{(\alpha)*}(g), \quad (24.15)$$

yielding the number of times the irreducible representation $T^{(\alpha)}$ occurs in the representation T .

Another useful relation is obtained if we multiply Eq. (24.14) by its complex conjugate and sum over g ; the result is

$$\begin{aligned}
\sum_{g \in G} |\chi(g)|^2 &= \sum_{g \in G} \chi(g) \chi^*(g) = \sum_{g \in G} \sum_{\alpha} m_{\alpha} \chi^{(\alpha)}(g) \sum_{\beta} m_{\beta} \chi^{(\beta)*}(g) \\
&= \sum_{\alpha, \beta} m_{\alpha} m_{\beta} \underbrace{\sum_{g \in G} \chi^{(\alpha)}(g) \chi^{(\beta)*}(g)}_{=|G|\delta_{\alpha\beta}} = |G| \sum_{\alpha} m_{\alpha}^2. \quad (24.16)
\end{aligned}$$

In particular, if T is irreducible, all m_{α} are zero except for one, which is unity. We therefore obtain the **criterion for irreducibility**:

$$\sum_{g \in G} |\chi(g)|^2 = \sum_{i=1}^r c_i |\chi_i|^2 = |G| \quad \text{if } T \text{ is irreducible.} \quad (24.17)$$

For groups of low order and representations of small dimensions, Eq. (24.16) becomes a powerful tool for testing the irreducibility of the representation.

Example 24.4.1 Let $G = S_3$ and consider the representation of Example 24.2.2. The characters of the first three elements of this representation are easily calculated:

$$\chi_1 = \text{tr } \mathbf{T}_1 = 3, \quad \chi_2 = \text{tr } \mathbf{T}_2 = 1, \quad \chi_3 = \text{tr } \mathbf{T}_3 = 1.$$

Similarly, one can obtain $\chi_4 = 1$, $\chi_5 = 0$, and $\chi_6 = 0$. Substituting this in Eq. (24.16) yields

$$\sum_{g \in G} |\chi(g)|^2 = \sum_{j=1}^6 |\chi_j|^2 = 3^2 + 1^2 + 1^2 + 1^2 + 0^2 + 0^2 = 12.$$

Comparing this with the RHS of (24.16) with $|G| = 6$ yields $\sum_{\alpha} m_{\alpha}^2 = 2$. This restricts the nonzero α 's to two, say $\alpha = 1$ and $\alpha = 2$. Moreover, m_1 and m_2 can be only 1. Thus, the representation of Example 24.2.2 is reducible, and there are precisely two inequivalent irreducible representations in it, each occurring once.

We can actually find the invariant subspaces corresponding to the two irreducible representations revealed above. The first is easy to guess. Just taking the sum of the three functions ψ_1 , ψ_2 , and ψ_3 gives a one-dimensional invariant subspace; so, let $\phi_1 \equiv \psi_1 + \psi_2 + \psi_3$, and note that the space \mathcal{W}_1 spanned by ϕ_1 is invariant. The second is harder to discover. However, if we *assume* that ψ_1 , ψ_2 , and ψ_3 are orthonormal, then using the Gram–Schmidt process, we can find the other two functions orthogonal to ϕ_1 (but not orthogonal to each other!). These are

$$\phi_2 = -\psi_1 + 2\psi_2 - \psi_3, \quad \phi_3 = -\psi_1 - \psi_2 + 2\psi_3.$$

The reader is urged to convince himself/herself that the subspace $\mathcal{W}^{(2)}$ spanned by ϕ_2 and ϕ_3 is the complement of $\mathcal{W}^{(1)}$ [i.e., $\mathcal{V} = \mathcal{W}^{(1)} \oplus \mathcal{W}^{(2)}$] and that it is invariant under all \mathbf{T}_g 's.

A very useful representation can be constructed as follows. Let $G = \{g_j\}_{j=1}^m$, and recall that left multiplication of elements of G by a fixed element g_i is a permutation of (g_1, g_2, \dots, g_m) . Denote this permutation by π_i . Now define a representation $R : G \rightarrow GL(\mathbb{R}^m)$, called the **regular representation**, by

$$\mathbf{R}_{g_i}(x_1, x_2, \dots, x_m) = (x_{\pi_i(1)}, x_{\pi_i(2)}, \dots, x_{\pi_i(m)}).$$

That this is indeed a representation is left as a problem for the reader. One can obtain a matrix representation of R by choosing the standard basis $\{\hat{e}_j\}_{j=1}^m$ of \mathbb{R}^m and noting that $\mathbf{R}_{g_i}\hat{e}_j = \hat{e}_{\pi_i^{-1}(j)}$. From such a matrix representation it follows that all characters χ^R of the regular representations are zero except for the identity, whose character is $\chi^R(e) = m$ [see Eq. (24.9)]. Now use Eq. (24.14) for $g = e$ and for the regular representation to obtain $m = \sum_{\alpha=1}^{\rho} m_{\alpha}n_{\alpha}$ where n_{α} is the dimension of the α -th irreducible representation. We can find m_{α} by using Eq. (24.15) and noting that only $g = e$ contributes to the sum:

$$m_{\alpha} = \frac{1}{|G|} \sum_{g \in G} \chi^R(g)\chi^{(\alpha)*}(g) = \frac{1}{m} \chi^R(e) \underbrace{\chi^{(\alpha)*}(e)}_{n_{\alpha}} = n_{\alpha}.$$

In words,

Box 24.4.2 *The number of times an irreducible representation occurs in the regular representation is equal to the dimension of that irreducible representation.*

We therefore obtain the important relations

$$\chi_i^R = |G|\delta_{i1} = \sum_{\alpha=1}^{\rho} n_{\alpha}\chi_i^{(\alpha)} \quad \text{and} \quad |G| = \sum_{\alpha=1}^{\rho} n_{\alpha}^2, \tag{24.18}$$

where we have assumed that the first conjugacy class is that of the identity. For finite groups of small order, the second equation can be very useful in obtaining the dimensions of irreducible representations.

Example 24.4.3 A group of order 2 or 3 has only one-dimensional inequivalent irreducible representations, because the only way that Eq. (24.18) can be satisfied for $|G| = 2$ or 3 is for all n_{α} 's to be 1. A group of order 4 can have either 4 one-dimensional or one 2-dimensional inequivalent irreducible representations. The symmetric group S_3 , being of order 6, can have 6 one-dimensional, or 2 one-dimensional and one 2-dimensional inequivalent irreducible representations. We shall see later that if all inequivalent irreducible representations of a group are one-dimensional, then the group must be abelian. Thus, the first possibility for S_3 must be excluded.

24.5 Group Algebra

group algebra defined

Think of group elements as (linearly independent) vectors. In fact, given any set, one can generate a vector space by taking linear combinations of the elements of the set assumed to form a basis. In the case of groups one gets a bonus: The product already defined on the basis (group elements) can be extended by linearity to all elements of the vector space to turn it into an algebra called the **group algebra**. For $G = \{g_j\}_{j=1}^m$, a typical element of the group algebra is $\mathbf{a} = \sum_{i=1}^m a_i g_i$. One can add two vectors as usual. But the product of two vectors is also defined:

$$\mathbf{ab} = \left(\sum_{i=1}^m a_i g_i \right) \left(\sum_{j=1}^m b_j g_j \right) = \sum_{i=1}^m \sum_{j=1}^m a_i b_j \underbrace{g_i g_j}_{g_k} \equiv \sum_{k=1}^m c_k g_k,$$

where c_k is a sum involving a_i and b_j . The best way to learn this is to see an example.

Example 24.5.1 Let $G = S_3$ and consider $\mathbf{a} = 2\pi_1 - 3\pi_3 + \pi_5$ and $\mathbf{b} = \pi_2 - 2\pi_4 + 3\pi_6$. Then, using Table 23.1, we obtain

$$\begin{aligned} \mathbf{ab} &= (2\pi_1 - 3\pi_3 + \pi_5)(\pi_2 - 2\pi_4 + 3\pi_6) \\ &= 2\pi_1\pi_2 - 4\pi_1\pi_4 + 6\pi_1\pi_6 - 3\pi_3\pi_2 + 6\pi_3\pi_4 \\ &\quad - 9\pi_3\pi_6 + \pi_5\pi_2 - 2\pi_5\pi_4 + 3\pi_5\pi_6 \\ &= 2\pi_2 - 4\pi_4 + 6\pi_6 - 3\pi_6 + 6\pi_5 - 9\pi_2 + \pi_4 - 2\pi_3 + 3\pi_1 \\ &= 3\pi_1 - 7\pi_2 - 2\pi_3 - 3\pi_4 + 6\pi_5 + 3\pi_6. \end{aligned}$$

24.5.1 Group Algebra and Representations

Group algebra is very useful for the construction and analysis of representations of groups. In fact, we have already used a similar approach in the construction of the regular representation. Instead of \mathbb{R}^m used before, use the m -dimensional vector space \mathcal{A} , the group algebra. Then left-multiplication by a group element g can be identified with $\mathbf{T}_g^{(R)}$, the operators of the regular representation, and the invariant subspaces of \mathcal{A} become the left ideals of \mathcal{A} , and we can write

$$\mathcal{A} = \mathcal{L}_1 \oplus \mathcal{L}_2 \oplus \cdots \oplus \mathcal{L}_r.$$

Moreover, since the identity element of the group is the identity element of resolution of the identity the algebra as well, we have

$$e = e_1 + \cdots + e_r, \quad e_i^2 = e_i, \quad e_i e_j = 0 \quad \text{for } i \neq j. \quad (24.19)$$

It is clear that if $\mathbf{a}^2 = \alpha \mathbf{a}$, then \mathbf{a}/α will be idempotent. So, we can essentially ignore the constant α , which is why \mathbf{a} is called **essentially idempotent**. Now consider the element of the group algebra

$$P = \sum_{x \in G} x \tag{24.20}$$

and note that $gP = \sum_{x \in G} gx = P$. It follows that

$$P^2 = \sum_{g \in G} g \sum_{x \in G} x = \sum_{g \in G} \sum_{x \in G} gx = \sum_{g \in G} P = |G|P.$$

So, P is essentially idempotent. Furthermore, the reader may verify that the ideal generated by P is one-dimensional.

Let us now apply the notion of the group algebra to derive further relations among characters. Denote the elements of the i th class K_i of G by $\{x_l^{(i)}\}_{l=1}^{c_i}$ and construct the element of the group algebra $\kappa_i \equiv \sum_{l=1}^{c_i} x_l^{(i)}$. If in the product of two such quantities

$$\kappa_i \kappa_j = \sum_{l=1}^{c_i} \sum_{m=1}^{c_j} x_l^{(i)} x_m^{(j)}, \tag{24.21}$$

$x_l^{(i)} x_m^{(j)} \equiv y \in G$, is in a certain conjugacy class, then the rest of that class can be obtained by taking all conjugates of y , i.e., elements of G that can be written as

$$gyg^{-1} = gx_l^{(i)} x_m^{(j)} g^{-1} = \underbrace{gx_l^{(i)} g^{-1}}_{\in K_i} \underbrace{gx_m^{(j)} g^{-1}}_{\in K_j}.$$

It follows that if one member of a class appears in the double sum of Eq. (24.21), all members will appear there. The reader may check that if y occurs k times in the double sum, then all members of the class of y occur k times as well. Collecting all such members together, we can write

$$\kappa_i \kappa_j = \sum_{l=1}^r c_{ijl} \kappa_l, \tag{24.22}$$

where c_{ijl} are positive integers.

Now consider the α th irreducible representation, and add all operators corresponding to a given class:

$$\mathbf{T}_i^{(\alpha)} \equiv \sum_{g \in K_i} \mathbf{T}_g^{(\alpha)} \Rightarrow \mathbf{T}_i^{(\alpha)} \mathbf{T}_j^{(\alpha)} = \sum_{l=1}^r c_{ijl} \mathbf{T}_l^{(\alpha)}, \tag{24.23}$$

where the second equation follows from the same sort of argument used above to establish Eq. (24.22). One can show that $\mathbf{T}_i^{(\alpha)}$ commutes with all $\mathbf{T}_g^{(\alpha)}$. Therefore, by Schur's lemma, $\mathbf{T}_i^{(\alpha)} = \lambda_i^{(\alpha)} \mathbf{1}$, and the second equation in (24.23) becomes

$$\lambda_i^{(\alpha)} \lambda_j^{(\alpha)} = \sum_{l=1}^r c_{ijl} \lambda_l^{(\alpha)}. \tag{24.24}$$

Taking the characters of both sides of $\mathbf{T}_i^{(\alpha)} = \lambda_i^{(\alpha)} \mathbf{1}$ and using the first equation in (24.23), noting that all elements of a class have the same character, we get

$$c_i \chi_i^{(\alpha)} = \lambda_i^{(\alpha)} n_\alpha \Rightarrow \lambda_i^{(\alpha)} = \frac{c_i \chi_i^{(\alpha)}}{n_\alpha}.$$

Substituting this in Eq. (24.24), we obtain

$$c_i c_j \chi_i^{(\alpha)} \chi_j^{(\alpha)} = n_\alpha \sum_{l=1}^r c_{ijl} c_l \chi_l^{(\alpha)}. \quad (24.25)$$

This is another equation that is useful for computing characters. Note that this equation connects the purely group properties (c_i 's and c_{ijl} 's) with the properties of the representation ($\chi_i^{(\alpha)}$'s and n_α). Summing Eq. (24.25) over α and using the first equation in (24.18), we get

$$c_i c_j \sum_{\alpha=1}^{\rho} \chi_i^{(\alpha)} \chi_j^{(\alpha)} = \sum_{l=1}^r c_{ijl} c_l \underbrace{\sum_{\alpha=1}^{\rho} n_\alpha \chi_l^{(\alpha)}}_{=|G|\delta_{l1} \text{ by (24.18)}} = c_{ij1} |G|$$

because $c_1 = 1$ (there is only one element in the class of the identity). Problem 24.12 shows that $c_{ij1} = c_i \delta_{i'j}$ where $K_{i'}$ is the class consisting of inverses of elements of K_i . It then follows that

$$\sum_{\alpha=1}^{\rho} \chi_i^{(\alpha)} \chi_j^{(\alpha)} = \frac{|G|}{c_j} \delta_{i'j}. \quad (24.26)$$

For a unitary representation, $\chi_{i'}^{(\alpha)} = \chi_i^{(\alpha)*}$, so Eq. (24.26) becomes

$$\sum_{\alpha=1}^{\rho} \chi_i^{(\alpha)} \chi_j^{(\alpha)*} = \frac{|G|}{c_j} \delta_{ij} \Rightarrow \langle \chi_j | \chi_i \rangle = \frac{|G|}{c_j} \delta_{ij}, \quad (24.27)$$

where $|\chi_i\rangle \in \mathbb{C}^\rho$ is a ρ -dimensional vector with components $\{\chi_i^{(\alpha)}\}_{\alpha=1}^{\rho}$. This equation can also be written in terms of group elements rather than classes. Since $\chi_i^{(\alpha)} = \chi^{(\alpha)}(x)$ for any $x \in K_i$, we have

$$\sum_{\alpha=1}^{\rho} \chi^{(\alpha)}(x) \chi^{(\alpha)*}(y) = \frac{|G|}{|K_x^G|} \delta(K_x^G, K_y^G), \quad (24.28)$$

where K_x^G is the conjugacy class of G containing x , $|K_x^G|$ is the number of its elements, and

$$\delta(K_x^G, K_y^G) = \begin{cases} 1 & \text{if } K_x^G = K_y^G, \\ 0 & \text{otherwise.} \end{cases}$$

Equation (24.27) shows that the r vectors $\chi_i^{(\alpha)}$ are mutually orthogonal; therefore, $r \leq \rho$. Combining this with Proposition 24.3.7, we obtain the following:

Table 24.1 A typical character table

| | $c_1 K_1$ | $c_2 K_2$ | ... | $c_i K_i$ | ... | $c_r K_r$ |
|----------------|---------------------|---------------------|-----|---------------------|-----|---------------------|
| $T^{(1)}$ | $\chi_1^{(1)}$ | $\chi_2^{(1)}$ | ... | $\chi_i^{(1)}$ | ... | $\chi_r^{(1)}$ |
| $T^{(2)}$ | $\chi_1^{(2)}$ | $\chi_2^{(2)}$ | ... | $\chi_i^{(2)}$ | ... | $\chi_r^{(2)}$ |
| ⋮ | ⋮ | ⋮ | | ⋮ | | ⋮ |
| $T^{(\alpha)}$ | $\chi_1^{(\alpha)}$ | $\chi_2^{(\alpha)}$ | ... | $\chi_i^{(\alpha)}$ | ... | $\chi_r^{(\alpha)}$ |
| ⋮ | ⋮ | ⋮ | | ⋮ | | ⋮ |
| $T^{(r)}$ | $\chi_1^{(r)}$ | $\chi_2^{(r)}$ | ... | $\chi_i^{(r)}$ | ... | $\chi_r^{(r)}$ |

Theorem 24.5.2 *The number of inequivalent irreducible representations of a finite group is equal to the number of conjugacy classes in the group.*

It is convenient to summarize our result in a square table with rows labeled by the irreducible representation and columns labeled by the conjugacy classes of G . Then on the α th row and i th column we list $\chi_i^{(\alpha)}$, and we get Table 24.1, called the **character table** of G . Note that c_i , the order of K_i , is written as a left superscript. Character tables have the property that any two of their rows are orthogonal in the sense of Eq. (24.12), and any two of their columns are orthogonal in the sense of Eq. (24.27).

character table of a finite group

If all inequivalent irreducible representations of a group G have dimension one, then there will be $|G|$ of them [by Eq. (24.18)]. Hence, there will be $|G|$ conjugacy classes; i.e., each class consists of a single element. By Problem 23.16, the group must be abelian. Combining this with Theorem 24.3.3, we have the following theorem.

Theorem 24.5.3 *A finite group is abelian if and only if all its inequivalent irreducible representations are one-dimensional.*

24.6 Relationship of Characters to Those of a Subgroup

Let H be a subgroup of G . Denote by K_h^H and K_g^G the H -class containing $h \in H$ and the G -class containing g , respectively. Let d_j and c_i be the number of elements in the j th H -class and i th G -class, respectively. Any representation of G defines a representation of H by restriction. An irreducible representation of G may be reducible as a representation of H . This is because although the subspace $\mathcal{W}^{(\alpha)}$ of the carrier space that is irreducible under G is the smallest such subspace containing a given vector, it is possible to generate a smaller subspace by applying a subset of the operators \mathbf{T}_g corresponding to those g 's that belong to H . It follows that

$$T^{(\alpha)}(h) = \sum_{\sigma} m_{\alpha\sigma} t^{(\sigma)}(h), \quad h \in H, \quad (24.29)$$

where $m_{\alpha\sigma}$ are nonnegative integers as in Eq. (24.14) and $t^{(\sigma)}$ are irreducible representations of H . If $\chi^{(\alpha)}$ and $\xi^{(\sigma)}$ denote the characters of irreducible representations of G and H , respectively, then the equivalent equation for the characters is

$$\chi^{(\alpha)}(h) = \sum_{\sigma} m_{\alpha\sigma} \xi^{(\sigma)}(h), \quad h \in H. \quad (24.30)$$

Multiply both sides by $\xi^{(\kappa)*}(h)$, sum over $h \in H$, and take the complex conjugate at the end. Then by the orthogonality relation (24.11), applied to H , we obtain

$$m_{\alpha\kappa} = \frac{1}{|H|} \sum_{h \in H} \chi^{(\alpha)*}(h) \xi^{(\kappa)}(h). \quad (24.31)$$

Now multiply both sides of Eq. (24.31) by $\chi^{(\alpha)}(g)$, sum over α , and use Eq. (24.28) to obtain

$$\sum_{\alpha} m_{\alpha\kappa} \chi^{(\alpha)}(g) = \frac{|G|}{|H||K_g^G|} \sum_{h \in H} \delta(K_h^G, K_g^G) \xi^{(\kappa)}(h). \quad (24.32)$$

The sum on the right can be transformed into a sum over conjugacy classes of H . Then Eq. (24.32) becomes

$$\sum_{\alpha} m_{\alpha\kappa} \chi_i^{(\alpha)} = \frac{|G|}{|H|c_i} \sum_j d_j \xi_j^{(\kappa)}, \quad i = 1, 2, \dots, r, \quad (24.33)$$

where the sum on the LHS is over irreducible representations of G , and on the RHS it is over those H -classes j that lie in the i th G -class. Note that the coefficients $|G|d_j/(|H|c_i)$ are integers by Problem 23.17.

Equations (24.32) and (24.33) are useful for obtaining characters of G when those of a subgroup H are known. The general procedure is to note that the RHS of these equations are completely determined by the structure of the group G and the characters of H . Varying i , the RHS of (24.33) determines the r components of a (compound) character $|\psi\rangle$, which, by the LHS, can be written as a linear combination of characters of G :

$$|\psi\rangle \equiv \sum_{\alpha=1}^r m_{\alpha} |\chi^{(\alpha)}\rangle, \quad (24.34)$$

where we have suppressed the irrelevant subscript κ . If we know some of the $|\chi^{(\alpha)}\rangle$'s, we may be able to determine the rest by taking successive inner products to find the integers m_{α} , and subtracting each irreducible factor of the sum from the LHS. We illustrate this procedure for S_n in the following example.

Example 24.6.1 Let $K_1 = (1^2)$ and $K_2 = (2)$ for S_2 (see Sect. 23.4 for notation). Example 24.2.7 showed that we can construct two irreducible representations for any S_n , the symmetric and the antisymmetric representations. The reader may verify that these two representations are inequivalent. Since

Table 24.2 Character table for S_2

| | 1K_1 | 1K_2 |
|-----------|-----------|-----------|
| $T^{(1)}$ | 1 | 1 |
| $T^{(2)}$ | 1 | -1 |

Table 24.3 Partially filled character table for S_3

| | 1K_1 | 3K_2 | 2K_3 |
|-----------|-----------|-----------|-----------|
| $T^{(1)}$ | 1 | 1 | 1 |
| $T^{(2)}$ | 1 | -1 | 1 |
| $T^{(3)}$ | ? | ? | ? |

the number of inequivalent irreducible representations is equal to the number of classes in a group, we have all the information needed to construct the character table for S_2 . Table 24.2 shows this character table. We want to use the S_2 character table to construct the character table for S_3 . With our knowledge of the symmetric and the antisymmetric representations, we can partially fill in the S_3 character table. Let $K_1 = (1^3)$, $K_2 = (2, 1)$, and $K_3 = (3)$ and note that $c_1 = 1$, $c_2 = 3$, and $c_3 = 2$. Then we obtain Table 24.3. To complete the table, we start with $\kappa = 1$, and write the RHS of Eq. (24.33) as

$$\psi_i = \frac{6}{2c_i} \sum_j d_j \xi_j^{(1)} = \frac{3}{c_i} \sum_j \xi_j^{(1)}$$

because $d_j = 1$ for the two classes of S_2 . The sum on the RHS is over S_2 -classes that are inside the i th S_3 -class. For $i = 1$, only the first S_2 -class contributes. Noting that $\xi_j^{(\kappa)}$ are the entries of Table 24.2, we get

$$\psi_1 = \frac{3}{c_1} \xi_1^{(1)} = \frac{3}{1} \cdot 1 = 3.$$

Similarly,

$$\psi_2 = \frac{3}{c_2} \xi_2^{(1)} = \frac{3}{3} \cdot 1 = 1 \quad \text{and} \quad \psi_3 = \frac{3}{c_3} \cdot 0 = 0.$$

The second equation follows from the fact that there are no classes of S_2 inside the third class of S_3 . Equation (24.34) now gives

$$|\psi\rangle = \begin{pmatrix} 3 \\ 1 \\ 0 \end{pmatrix} = \sum_{\alpha=1}^r m_\alpha |\chi^{(\alpha)}\rangle.$$

We can find the number of times $|\chi^{(1)}\rangle$ occurs in this compound character by taking the inner product:

$$\langle \chi^{(1)} | \psi \rangle = \sum_{\alpha=1}^r m_\alpha \langle \chi^{(1)} | \chi^{(\alpha)} \rangle = m_1 |G| = 6m_1.$$

Table 24.4 Complete character table for S_3

| | 1K_1 | 3K_2 | 2K_3 |
|-----------|-----------|-----------|-----------|
| $T^{(1)}$ | 1 | 1 | 1 |
| $T^{(2)}$ | 1 | -1 | 1 |
| $T^{(3)}$ | 2 | 0 | -1 |

But

$$\langle \chi^{(1)} | \psi \rangle = \sum_{i=1}^r c_i \chi_i^{(1)} \psi_i = 1 \cdot 1 \cdot 3 + 3 \cdot 1 \cdot 1 + 2 \cdot 1 \cdot 0 = 6.$$

These two equations show that $m_1 = 1$. So,

$$\begin{pmatrix} 3 \\ 1 \\ 0 \end{pmatrix} = \begin{pmatrix} 1 \\ 1 \\ 1 \end{pmatrix} + m_2 |\chi^{(2)}\rangle + m_3 |\chi^{(3)}\rangle.$$

Subtracting the column vectors, we get a new character:

$$|\psi'\rangle \equiv \begin{pmatrix} 2 \\ 0 \\ -1 \end{pmatrix} = m_2 |\chi^{(2)}\rangle + m_3 |\chi^{(3)}\rangle.$$

Taking the inner product with $|\chi^{(2)}\rangle$ yields $m_2 = 0$. It follows that $|\psi'\rangle$ is a simple character. In fact,

$$\sum_i c_i |\psi'_i|^2 = 1 \cdot 2^2 + 3 \cdot 0^2 + 2 \cdot (-1)^2 = 6,$$

and the criterion of irreducibility, Eq. (24.17), is satisfied.

We can now finish up Table 24.3 to obtain Table 24.4, which is the complete character table for S_3 .

24.7 Irreducible Basis Functions

We have studied the operators \mathbf{T}_g and their characters representing group elements in rather extensive detail. Let us now turn our attention to the carrier space itself. In particular, we want to concentrate on the basis functions of the irreducible representations. We choose “functions,” rather than vectors, because of their use in quantum mechanics as discussed at the beginning of this chapter.

Let $\{|\psi_i^{(\alpha)}\rangle\}_{i=1}^{n_\alpha}$ be a set of basis functions for $\mathcal{W}^{(\alpha)}$, the α th invariant irreducible subspace. Invariance of $\mathcal{W}^{(\alpha)}$ implies that

$$\mathbf{T}_g |\psi_i^{(\alpha)}\rangle = \sum_{j=1}^{n_\alpha} T_{ji}^{(\alpha)}(g) |\psi_j^{(\alpha)}\rangle,$$

where $T_{ji}^{(\alpha)}(g)$ are elements of the matrix $\mathbf{T}_g^{(\alpha)}$ representing $g \in G$.

Definition 24.7.1 A function (or vector) $|\phi_i^{(\alpha)}\rangle$ is said to **belong to the i th row of the α th irreducible representation** (or to transform according to the i th row of the α th irreducible representation) if there exists a basis $\{|\psi_i^{(\alpha)}\rangle\}_{i=1}^{n_\alpha}$ of the α th irreducible representation of G with matrices $(T_{ji}^{(\alpha)}(g))$ and $n_\alpha - 1$ other functions $\{|\phi_j^{(\alpha)}\rangle\}$ such that

$$\mathbf{T}_g |\phi_i^{(\alpha)}\rangle = \sum_{j=1}^{n_\alpha} T_{ji}^{(\alpha)}(g) |\phi_j^{(\alpha)}\rangle. \tag{24.35}$$

Functions that belong to rows of irreducible representations have some remarkable properties. Let $|\psi_i^{(\alpha)}\rangle$ and $|\phi_j^{(\beta)}\rangle$ transform according to the i th and j th rows of the α th and β th irreducible representations, respectively. Choose an inner product for the carrier space such that all representations are unitary. Then we have

$$\begin{aligned} \langle \psi_i^{(\alpha)} | \phi_j^{(\beta)} \rangle &= \langle \mathbf{T}_g \psi_i^{(\alpha)} | \mathbf{T}_g \phi_j^{(\beta)} \rangle \\ &= \sum_{l=1}^{n_\alpha} \sum_{m=1}^{n_\beta} T_{li}^{(\alpha)*}(g) T_{mj}^{(\beta)}(g) \langle \psi_l^{(\alpha)} | \phi_m^{(\beta)} \rangle. \end{aligned}$$

Summing this equation over g yields $|G| \langle \psi_i^{(\alpha)} | \phi_j^{(\beta)} \rangle$ for the LHS, while

$$\begin{aligned} \text{RHS} &= \sum_{l=1}^{n_\alpha} \sum_{m=1}^{n_\beta} \overbrace{\sum_{g \in G} T_{li}^{(\alpha)*}(g) T_{mj}^{(\beta)}(g)}^{(|G|/n_\alpha) \delta_{\alpha\beta} \delta_{lm} \delta_{ij}} \langle \psi_l^{(\alpha)} | \phi_m^{(\beta)} \rangle \\ &= \frac{|G|}{n_\alpha} \delta_{\alpha\beta} \delta_{ij} \sum_{l=1}^{n_\alpha} \langle \psi_l^{(\alpha)} | \phi_l^{(\beta)} \rangle, \end{aligned}$$

where we have made use of Eq. (24.8). Therefore,

$$\langle \psi_i^{(\alpha)} | \phi_j^{(\beta)} \rangle = \frac{1}{n_\alpha} \delta_{\alpha\beta} \delta_{ij} \sum_{l=1}^{n_\alpha} \langle \psi_l^{(\alpha)} | \phi_l^{(\alpha)} \rangle. \tag{24.36}$$

This shows that functions belonging to different irreducible representations are orthogonal. We should expect this, because in our construction of invariant irreducible subspaces, we kept dividing the whole space into orthogonal complements. What is surprising is that *functions transforming according to different rows of an irreducible representation are orthogonal*. We had no control over this property! It is a consequence of Eq. (24.35). Another surprise is the independence of the inner product from i : If we let $i = j$ and $\alpha = \beta$ on both sides of (24.36), we obtain

$$\langle \psi_i^{(\alpha)} | \phi_i^{(\alpha)} \rangle = \frac{1}{n_\alpha} \sum_{l=1}^{n_\alpha} \langle \psi_l^{(\alpha)} | \phi_l^{(\alpha)} \rangle, \tag{24.37}$$

which indicates that the inner product on the LHS is independent of i .

symmetry and the quantum mechanical perturbation theory; lifting of degeneracy

Example 24.7.2 The quantum-mechanical perturbation theory starts with a known Hamiltonian \mathbf{H}_0 with eigenvalues E_i and the corresponding eigenstates $|E_i\rangle$. Subsequently, a (small) perturbing “potential” \mathbf{V} is added to the Hamiltonian, and the eigenvalues and eigenstates of the new Hamiltonian $\mathbf{H} = \mathbf{H}_0 + \mathbf{V}$ are sought. One can draw important conclusions about the eigenvalues and eigenstates of the total Hamiltonian by symmetry arguments.

Suppose the symmetry group of \mathbf{H}_0 is G , and that of \mathbf{H} is H , which has to be a subgroup of G . In most cases, the eigenspaces of \mathbf{H}_0 are irreducible carrier spaces of G , i.e., their basis vectors transform according to the rows of irreducible representations of G . If H is a proper subgroup of G , then the eigenspaces of \mathbf{H}_0 will split according to Eq. (24.29). We say that some of the *degeneracy is lifted* because of the perturbation \mathbf{V} . The nature of the split, i.e., the number and the dimensionality of the vector spaces into which a given eigenspace splits, can be obtained by the characters of G and H and Eq. (24.30). The original eigenspaces are represented on an *energy diagram* with a line corresponding to each eigenspace. The split of the eigenspace into k new subspaces is then indicated by the branching of the old line into k new lines.

To the lowest approximation—first-order perturbation theory—the magnitude of the split, i.e., the difference between the eigenvalues of \mathbf{H}_0 and those of \mathbf{H} , is given by [see Eq. (21.57)] the expectation value $\langle \phi_i^{(\alpha)} | \mathbf{V} | \phi_j^{(\alpha)} \rangle$, where $|\phi_i^{(\alpha)}\rangle$ belongs to the i th row of the α th irreducible representation, and $|\phi_j^{(\alpha)}\rangle$ to its j th row ($i \neq j$). Only if this expectation value is nonzero will a split occur. This, in turn, depends on the symmetry of \mathbf{V} : If \mathbf{V} is at least as symmetric as \mathbf{H}_0 (corresponding to $G = H$), then $\langle \phi_i^{(\alpha)} | \mathbf{V} | \phi_j^{(\alpha)} \rangle = 0$, and no splitting occurs (Problem 24.17). If, on the other hand, \mathbf{V} is less symmetric than \mathbf{H}_0 (corresponding to $H \subset G$), then $\mathbf{V} | \phi_j^{(\alpha)} \rangle$ will not belong to the j th row of the α th irreducible representation, and in general, $\langle \phi_i^{(\alpha)} | \mathbf{V} | \phi_j^{(\alpha)} \rangle \neq 0$.

We have decomposed the carrier space \mathcal{V} of a representation into invariant irreducible subspaces $\mathcal{W}^{(\alpha)}$. The argument above shows that each $\mathcal{W}^{(\alpha)}$ has a basis consisting of the “rows” of the irreducible representations. Corresponding to such a basis, there is a set of projection operators $\mathbf{P}_i^{(\alpha)}$ with the property $\sum_{\alpha,i} \mathbf{P}_i^{(\alpha)} = \mathbf{1}$ (Chap. 6). Our aim is to find an expression for these operators, which have the defining property $\mathbf{P}_i^{(\alpha)} |\psi_i^{(\alpha)}\rangle = |\psi_i^{(\alpha)}\rangle$. We start with Eq. (24.35), multiply both sides of it by $T_{lm}^{(\beta)*}(g)$, sum over $g \in G$, and use Eq. (24.8) to obtain

$$\begin{aligned} \sum_{g \in G} T_{lm}^{(\beta)*}(g) \mathbf{T}_g |\psi_i^{(\alpha)}\rangle &= \sum_{j=1}^{n_\alpha} |\psi_j^{(\alpha)}\rangle \sum_{g \in G} T_{lm}^{(\beta)*}(g) T_{ji}^{(\alpha)}(g) \\ &= \frac{|G|}{n_\alpha} \sum_{j=1}^{n_\alpha} |\psi_j^{(\alpha)}\rangle \delta_{lj} \delta_{mi} \delta_{\alpha\beta} = \frac{|G|}{n_\alpha} |\psi_l^{(\alpha)}\rangle \delta_{mi} \delta_{\alpha\beta}. \end{aligned}$$

Let $\beta = \alpha, m = l = i$, and multiply both sides by $n_\alpha/|G|$. Then this equation becomes

$$\frac{n_\alpha}{|G|} \sum_{g \in G} T_{ii}^{(\alpha)*}(g) \mathbf{T}_g |\psi_i^{(\alpha)}\rangle = |\psi_i^{(\alpha)}\rangle,$$

which suggests the identification

$$\mathbf{P}_i^{(\alpha)} = \frac{n_\alpha}{|G|} \sum_{g \in G} T_{ii}^{(\alpha)*}(g) \mathbf{T}_g \tag{24.38}$$

projection operator onto the i th row of the α th irreducible representation

with the properties

$$\mathbf{P}_i^{(\alpha)} |\psi_j^{(\beta)}\rangle = |\psi_i^{(\alpha)}\rangle \delta_{ij} \delta_{\alpha\beta}, \quad \mathbf{P}_i^{(\alpha)} |\phi\rangle = |\phi_i^{(\alpha)}\rangle, \tag{24.39}$$

where $|\phi_i^{(\alpha)}\rangle$ is the projection of $|\phi\rangle$ along the i th row of the α th irreducible representation.

We are also interested in the projection operator that projects onto the irreducible subspace $\mathcal{W}^{(\alpha)}$. Such an operator is obtained by summing $\mathbf{P}_i^{(\alpha)}$ over i . We thus obtain

$$\mathbf{P}^{(\alpha)} = \frac{n_\alpha}{|G|} \sum_{g \in G} \underbrace{\sum_{i=1}^{n_\alpha} T_{ii}^{(\alpha)*}(g)}_{=\chi^{(\alpha)*}(g)} \mathbf{T}_g = \frac{n_\alpha}{|G|} \sum_{g \in G} \chi^{(\alpha)*}(g) \mathbf{T}_g \tag{24.40}$$

projection operator onto the α th irreducible representation

and

$$\mathbf{P}^{(\alpha)} |\psi^{(\beta)}\rangle = |\psi^{(\alpha)}\rangle \delta_{\alpha\beta}, \quad \mathbf{P}^{(\alpha)} |\phi\rangle = |\phi^{(\alpha)}\rangle, \tag{24.41}$$

where $|\phi^{(\alpha)}\rangle$ is the projection of $|\phi\rangle$ onto the α th irreducible invariant subspace. These formulas are extremely useful in identifying the irreducible subspaces of a given carrier space:

Box 24.7.3 Start with a basis $\{|a_i\rangle\}$ of the carrier space, apply $\mathbf{P}^{(\alpha)}$ of Eq. (24.40) to all basis vectors, and collect all the linearly independent vectors of the form $\mathbf{P}^{(\alpha)}|a_i\rangle$. These vectors form a basis of the α th irreducible representation.

The following example illustrates this point.

Example 24.7.4 Consider the representation of S_3 given in Example 24.2.2, where the carrier space is the span of the three functions $|\psi_1\rangle = xy$, $|\psi_2\rangle = yz$, and $|\psi_3\rangle = xz$.

We refer to the character table for S_3 (Table 24.4) and use Eq. (24.40) to obtain

$$\begin{aligned} \mathbf{P}^{(1)} &= \frac{1}{6}(\mathbf{T}_1 + \mathbf{T}_2 + \mathbf{T}_3 + \mathbf{T}_4 + \mathbf{T}_5 + \mathbf{T}_6), \\ \mathbf{P}^{(2)} &= \frac{1}{6}(\mathbf{T}_1 - \mathbf{T}_2 - \mathbf{T}_3 - \mathbf{T}_4 + \mathbf{T}_5 + \mathbf{T}_6), \end{aligned}$$

$$\mathbf{P}^{(3)} = \frac{2}{6}(2\mathbf{T}_1 - \mathbf{T}_5 - \mathbf{T}_6),$$

where, as in Example 24.2.2, we have used the notation \mathbf{T}_i for \mathbf{T}_{π_i} , and the result $n_1 = n_2 = 1$ and $n_3 = 2$ obtained from Eq. (24.18), Theorem 24.5.3, and the fact that S_3 is nonabelian.

To get the first irreducible subspace of this representation, we apply $\mathbf{P}^{(1)}$ to $|\psi_1\rangle$. Since this subspace is one-dimensional, the procedure will give a basis for it if the vector so obtained is nonzero:

$$\begin{aligned} \mathbf{P}^{(1)}|\psi_1\rangle &= \frac{1}{6}(\mathbf{T}_1 + \mathbf{T}_2 + \mathbf{T}_3 + \mathbf{T}_4 + \mathbf{T}_5 + \mathbf{T}_6)|\psi_1\rangle \\ &= \frac{1}{6}(|\psi_1\rangle + |\psi_1\rangle + |\psi_2\rangle + |\psi_3\rangle + |\psi_3\rangle + |\psi_2\rangle) \\ &= \frac{1}{3}(|\psi_1\rangle + |\psi_2\rangle + |\psi_3\rangle). \end{aligned}$$

This is a basis for the carrier space of the irreducible identity representation.

For the second irreducible representation, we get

$$\mathbf{P}^{(2)}|\psi_1\rangle = \frac{1}{6}(|\psi_1\rangle - |\psi_1\rangle - |\psi_2\rangle - |\psi_3\rangle + |\psi_3\rangle + |\psi_2\rangle) = 0.$$

Similarly, $\mathbf{P}^{(2)}|\psi_2\rangle = 0$ and $\mathbf{P}^{(2)}|\psi_3\rangle = 0$. This means that $T^{(2)}$ is not included in the representation we are working with. We should have expected this, because if this one-dimensional irreducible representation were included, it would force the last irreducible representation to be one-dimensional as well [see Eq. (24.18)], and, by Theorem 24.5.3, the group S_3 to be abelian!

The last irreducible representation is obtained similarly. We have

$$\begin{aligned} \mathbf{P}^{(3)}|\psi_1\rangle &= \frac{1}{3}(2\mathbf{T}_1 - \mathbf{T}_5 - \mathbf{T}_6)|\psi_1\rangle = \frac{1}{3}(2|\psi_1\rangle - |\psi_3\rangle - |\psi_2\rangle), \\ \mathbf{P}^{(3)}|\psi_2\rangle &= \frac{1}{3}(2\mathbf{T}_1 - \mathbf{T}_5 - \mathbf{T}_6)|\psi_2\rangle = \frac{1}{3}(2|\psi_2\rangle - |\psi_1\rangle - |\psi_3\rangle). \end{aligned}$$

These two vectors are linearly independent. Therefore, they form a basis for the last irreducible representation. The reader may check that $\mathbf{P}^{(3)}|\psi_3\rangle$ is a linear combination of $\mathbf{P}^{(3)}|\psi_1\rangle$ and $\mathbf{P}^{(3)}|\psi_2\rangle$.

24.8 Tensor Product of Representations

A simple quantum mechanical system possessing a group of symmetry is described by vectors that transform irreducibly (or according to a row of an irreducible representation). For example, a rotationally invariant system can be described by an eigenstate of angular momentum, the generator of rotation.³ These eigenstates transform as rows of irreducible representations

³Chapter 29 will make explicit the connection between groups and their generators.

of the rotation group. At a more fundamental level, the very concept of a particle or field is thought of as states that transform irreducibly under the fundamental group of spacetime, the Poincaré group.

Often these irreducible states are “combined” to form new states. For example, the state of two (noninteracting) particles is described by a two-particle state, labeled by the combined eigenvalues of the two sets of operators that describe each particle separately. In the case of angular momentum, the single-particle states may be labeled as $|l_i, m_i\rangle$ for $i = 1, 2$. Then the combined state will be labeled as $|l_1, m_1; l_2, m_2\rangle$, and one can define an action of the rotation group on the vector space spanned by these combined states to construct a representation. We now describe the way in which this is done.

Let $T : G \rightarrow GL(\mathcal{V})$ and $S : G \rightarrow GL(\mathcal{W})$ be two representations of a group G . Define an action of the group G on $\mathcal{V} \otimes \mathcal{W}$, the tensor product of \mathcal{V} and \mathcal{W} , via the representation $T \otimes S : G \rightarrow GL(\mathcal{V} \otimes \mathcal{W})$ given by

$$(T \otimes S)(g)(|v\rangle, |w\rangle) = (T(g)|v\rangle, S(g)|w\rangle).$$

We note that

$$\begin{aligned} (T \otimes S)(g_1 g_2)(|v\rangle, |w\rangle) &= (T(g_1 g_2)|v\rangle, S(g_1 g_2)|w\rangle) \\ &= (T(g_1)T(g_2)|v\rangle, S(g_1)S(g_2)|w\rangle) \\ &= (T \otimes S)(g_1)(T \otimes S)(g_2)(|v\rangle, |w\rangle) \\ &= [(T \otimes S)(g_1)(T \otimes S)(g_2)](|v\rangle, |w\rangle). \end{aligned}$$

It follows that $T \otimes S$ is indeed a representation, called the **tensor product** or **direct product** or **Kronecker product** representation. It is common, especially in the physics literature, to write $|v, w\rangle$, or simply $|vw\rangle$ for $(|v\rangle, |w\rangle)$, and TS for $T \otimes S$. If we choose the orthonormal bases $\{|v_i\rangle\}$ for \mathcal{V} and $\{|w_a\rangle\}$ for \mathcal{W} , and define an inner product on $\mathcal{V} \otimes \mathcal{W}$ by

Kronecker product representation

$$\langle v, w | v', w' \rangle \equiv \langle v | v' \rangle \langle w | w' \rangle,$$

we obtain a matrix representation of the group with matrix elements given by

$$\begin{aligned} (T \otimes S)_{ia, jb}(g) &\equiv \langle v_i, w_a | T \otimes S(g) | v_j, w_b \rangle \\ &= \langle v_i | T(g) | v_j \rangle \langle w_a | S(g) | w_b \rangle \equiv T_{ij}(g) S_{ab}(g). \end{aligned}$$

Note that the rows and columns of this matrix are distinguished by double indices. If the matrix T is $m \times m$ and S is $n \times n$, then the matrix $T \otimes S$ is $(mn) \times (mn)$. The character of the tensor product representation is

character of a product representation is a product of characters

$$\begin{aligned} \chi^{T \otimes S}(g) &= \sum_{i,a} (T \otimes S)_{ia, ia}(g) = \sum_{i,a} T_{ii}(g) S_{aa}(g) = \sum_i T_{ii}(g) \sum_a S_{aa}(g) \\ &= \chi^T(g) \chi^S(g) \Rightarrow \chi_i^{T \otimes S} = \chi_i^T \cdot \chi_i^S. \end{aligned} \tag{24.42}$$

So the character of the tensor product is the product of the individual characters.

An important special case is the tensor product of a representation with itself. For such a representation, the matrix elements satisfy the symmetry relation

$$(T \otimes T)_{ia,jb}(g) = (T \otimes T)_{ai,bj}(g).$$

This symmetry can be used to decompose the tensor product space into two subspaces that are separately invariant under the action of the group. To do this, take the span of all the symmetric vectors of the form $(|v_i w_j\rangle + |v_j w_i\rangle) \in \mathcal{V} \otimes \mathcal{V}$ and denote it by $(\mathcal{V} \otimes \mathcal{V})_s$. Similarly, take the span of all the antisymmetric vectors of the form $(|v_i w_j\rangle - |v_j w_i\rangle) \in \mathcal{V} \otimes \mathcal{V}$ and denote it by $(\mathcal{V} \otimes \mathcal{V})_a$. Next note that

$$|v_i w_j\rangle = \frac{1}{2}(|v_i w_j\rangle + |v_j w_i\rangle) + \frac{1}{2}(|v_i w_j\rangle - |v_j w_i\rangle).$$

It follows that every vector of the product space can be written as the sum of a symmetric and an antisymmetric vector. Furthermore, the only vector that is both symmetric and antisymmetric is the zero vector. Therefore,

$$\mathcal{V} \otimes \mathcal{V} = (\mathcal{V} \otimes \mathcal{V})_s \oplus (\mathcal{V} \otimes \mathcal{V})_a.$$

Now consider the action of the group on each of these subspaces separately. From the relation

$$\begin{aligned} (T \otimes T)(g)|v_i w_j\rangle &\equiv (T \otimes T)(g)(|v_i\rangle, |w_j\rangle) \\ &= \left(\sum_k T_{ki}(g)|v_k\rangle, \sum_l T_{lj}(g)|w_l\rangle \right) \\ &= \sum_{k,l} T_{ki} T_{lj}(g)(g)(|v_k\rangle, |w_l\rangle) \\ &= \sum_{k,l} (T \otimes T)_{kl,ij}(g)|v_k w_l\rangle \end{aligned}$$

we obtain

$$\begin{aligned} (T \otimes T)(g)(|v_i w_j\rangle \pm |v_j w_i\rangle) \\ = \sum_{k,l} [(T \otimes T)_{kl,ij}(g) \pm (T \otimes T)_{kl,ji}(g)]|v_k w_l\rangle. \end{aligned} \quad (24.43)$$

Kronecker product
reduces to the
symmetric and the
antisymmetric
representations

Problem 24.21 shows that the RHS can be written as a sum over the symmetric (for the plus sign) or antisymmetric (for the minus sign) vectors alone. It follows that

Box 24.8.1 *The Kronecker product of a representation with itself is always reducible into two representations, the **symmetrized product** and the **antisymmetrized product** representations.*

24.8.1 Clebsch-Gordan Decomposition

A common situation in quantum mechanics is to combine two simple systems into a composite system and see which properties of the original simple systems the composite system retains. For example, combining the angular momenta of two particles gives a new total angular momentum operator. The question of what single-particle angular momentum states are included in the states of the total angular momentum operator is the content of **selection rules** and is of great physical interest: A quark and an antiquark (two fermions) with spin $\frac{1}{2}$ always combine to form a meson (a boson), because the resulting composite state has no projection onto the subspace spanned by half-integer-spin particles. In this section, we study the mathematical foundation of this situation. The tensor product of two irreducible representations $T^{(\alpha)}$ and $T^{(\beta)}$ of G is denoted by $T^{(\alpha \times \beta)}$, and it is, in general, a reducible representation. The characters, generally compound, are denoted by $\chi^{(\alpha \times \beta)}$. Equation (24.14), combined with Eq. (24.42), tells us what irreducible representations are present in the tensor product, and therefore onto which irreducible representations the product representation has nonzero projection:

selection rules

$$\chi_i^{(\alpha \times \beta)} = \chi_i^{(\alpha)} \cdot \chi_i^{(\beta)} = \sum_{\sigma=1}^r m_{\sigma}^{\alpha\beta} \chi_i^{(\sigma)},$$

where $m_{\sigma}^{\alpha\beta}$ are nonnegative integers. We rewrite this more conveniently in terms of vectors as

$$\begin{aligned} |\chi^{(\alpha \times \beta)}\rangle &= \sum_{\sigma=1}^r m_{\sigma}^{\alpha\beta} |\chi^{(\sigma)}\rangle, \\ m_{\sigma}^{\alpha\beta} &= \frac{1}{|G|} \langle \chi^{(\sigma)} | \chi^{(\alpha \times \beta)} \rangle = \frac{1}{|G|} \sum_{i=1}^r c_i \bar{\chi}_i^{(\sigma)} \chi_i^{(\alpha)} \chi_i^{(\beta)}. \end{aligned} \quad (24.44)$$

A group for which $m_{\sigma}^{\alpha\beta} = 0, 1$ is called **simply reducible**.

simply reducible group

Historical Notes

Rudolph Friedrich Alfred Clebsch (1833–1872) studied mathematics in the shadow of Jacobi at the University of Königsberg, two of his teachers having been students of Jacobi. After graduation he held a number of positions in Germany, including positions at the universities of Berlin, Giessen, and finally Göttingen, where he remained until his death. He and Carl Neumann, the son of one of the aforementioned teachers who were students of Jacobi, founded the *Mathematische Annalen*.

Clebsch began his career in mathematical physics, producing a doctoral thesis on hydrodynamics and a book on elasticity in which he treated the elastic vibrations of rods and plates. These works were primarily mathematical, however, and he soon turned his attention more to pure mathematics. His links to Jacobi gave rise to his first work in that vein, concerning problems in variational calculus and partial differential equations, in which he surpassed the results of Jacobi's work.

Clebsch first achieved significant recognition for his work in projective invariants and algebraic geometry. He was intrigued by the interplay between algebra and geometry, and, since many results in the theory of invariants have geometric interpretations, the two fields seemed natural choices.



Rudolph Friedrich Alfred Clebsch 1833–1872

Example 24.8.2 Referring to Table 24.5 of Problem 24.15, and using Eq. (24.42), we can construct the compound character $|\chi^{(4 \times 5)}\rangle$ with components 9, -1 , 1, 0, -1 . Then, we have

$$|\chi^{(4 \times 5)}\rangle = \begin{pmatrix} 9 \\ -1 \\ 1 \\ 0 \\ -1 \end{pmatrix} = \sum_{\sigma=1}^5 m_{\sigma}^{45} |\chi^{(\sigma)}\rangle, \quad m_{\sigma}^{45} = \frac{1}{24} \langle \chi^{(\sigma)} | \chi^{(4 \times 5)} \rangle.$$

For the first irreducible representation, we get

$$\begin{aligned} m_1^{45} &= \frac{1}{24} \langle \chi^{(1)} | \chi^{(4 \times 5)} \rangle = \frac{1}{24} \sum_{i=1}^5 c_i \chi_i^{(1)*} \chi_i^{(4 \times 5)} \\ &= \frac{1}{24} [1 \cdot 1 \cdot 9 + 6 \cdot 1 \cdot (-1) + 3 \cdot 1 \cdot 1 + 8 \cdot 1 \cdot 0 + 6 \cdot 1 \cdot (-1)] = 0. \end{aligned}$$

For the second irreducible representation, we get

$$\begin{aligned} m_2^{45} &= \frac{1}{24} \langle \chi^{(2)} | \chi^{(4 \times 5)} \rangle \\ &= \frac{1}{24} [1 \cdot 1 \cdot 9 + 6 \cdot (-1) \cdot (-1) + 3 \cdot 1 \cdot 1 + 8 \cdot (-1) \cdot 0 \\ &\quad + 6 \cdot (-1) \cdot (-1)] = 1. \end{aligned}$$

Similarly, $m_3^{45} = 1$, $m_4^{45} = 1$, and $m_5^{45} = 1$. We thus see that the identity representation is not included in the direct product of irreducible representations 4 and 5; all other irreducible representations of S_4 occur once in $T^{(4 \times 5)}$.

Clebsch-Gordan series

In terms of representations themselves, we have the so-called **Clebsch-Gordan series**

$$T^{(\alpha \times \beta)}(g) = \sum_{\sigma=1}^r m_{\sigma}^{\alpha\beta} T^{(\sigma)}(g), \quad m_{\sigma}^{\alpha\beta} = \frac{1}{|G|} \sum_{i=1}^r c_i \bar{\chi}_i^{(\sigma)} \chi_i^{(\alpha)} \chi_i^{(\beta)}, \quad (24.45)$$

where we have used Eq. (24.13)

How to obtain invariants from the product of representations

The one-dimensional identity representation plays a special role in the application of group theory to physics because any vector (function) in its carrier space is invariant under the action of the group, and invariant vectors often describe special states of the quantum mechanical systems. For example, the ground state of an atomic system with rotational invariance has zero orbital angular momentum, corresponding to a spherically symmetric state.

Another example comes from particle physics. Quarks are usually placed in the states of an irreducible representation of a group $[SU(n)]$, where n is the number of “flavors” such as up, down, charm, and antiquarks in its adjoint. A question of great importance is what combination of quarks and antiquarks leads to particles—called singlets—that are an invariant of the

group. For the case of quark-antiquark combination, the answer comes in the analysis of the tensor product of one irreducible representation, say $T^{(\alpha)}$, and one adjoint representation, say $\bar{T}^{(\beta)}$. In fact, using Eq. (24.45), we have

$$m_1^{\alpha\beta} = \frac{1}{|G|} \sum_{i=1}^r c_i \bar{\chi}_i^{(1)} \chi_i^{(\alpha)} \bar{\chi}_i^{(\beta)} = \frac{1}{|G|} \sum_{i=1}^r c_i \chi_i^{(\alpha)} \bar{\chi}_i^{(\beta)} = \delta_{\alpha\beta},$$

where we used Eq. (24.13) and the fact that all characters of the identity representation are unity. Thus

Box 24.8.3 *To construct an invariant state, we need to combine a representation with its adjoint, in which case we obtain the identity representation only once.*

Historical Notes

Paul Albert Gordan (1837–1912), the son of David Gordan, a merchant, attended gymnasium and business school, then worked for several years in banks. His early interest in mathematics was encouraged by the private tutoring he received from a professor at the *Friedrich Wilhelm Gymnasium*. He attended Ernst Kummer's lectures in number theory at the University of Berlin in 1855, then studied at the universities of Breslau, Königsberg, and Berlin. At Königsberg he came under the influence of Karl Jacobi's school, and at Berlin his interest in algebraic equations was aroused. His dissertation (1862), which concerned geodesics on spheroids, received a prize offered by the philosophy faculty of the University of Breslau. The techniques that Gordan employed in it were those of Lagrange and Jacobi.

Gordan's interest in function theory led him to visit G.F.B. Riemann in Göttingen in 1862, but Riemann was ailing, and their association was brief. The following year, Gordan was invited to Giessen by Clebsch, thus beginning the fruitful collaboration most physicists recognize. Together they produced work on the theory of Abelian functions, based on Riemann's fundamental paper on that topic, and several of Clebsch's papers are considered important steps toward establishing for Riemann's theories a firm foundation in terms of pure algebraic geometry. Of course, the Clebsch-Gordan collaboration also produced the famous coefficients that bear their names, so indispensable to the theory of angular momentum coupling found in almost every area of modern physics.

In 1874 Gordan became a professor at Erlangen, where he remained until his retirement in 1910. He married Sophie Deuer, the daughter of a Giessen professor of Roman law, in 1869. In 1868 Clebsch introduced Gordan to the theory of invariants, which originated in an observation of George Boole's in 1841 and was further developed by Arthur Cayley in 1846. Following the work of these two Englishmen, a German branch of the theory was developed by S.H. Aronhold and Clebsch, the latter elaborating the former's symbolic methods of characterizing algebraic forms and their invariants. Invariant theory was Gordan's main interest for the rest of his mathematical career; he became known as the greatest expert in the field, developing many techniques for representing and generating forms and their invariants.

Gordan made important contributions to algebra and solutions of algebraic equations, and gave simplified proofs of the transcendence of e and π . The overall style of Gordan's mathematical work was algorithmic. He shied away from presenting his ideas in informal literary forms. He derived his results computationally, working directly toward the desired goal without offering explanations of the concepts that motivated his work.

Gordan's only doctoral student, Emmy Noether, was one of the first women to receive a doctorate in Germany. She carried on his work in invariant theory for a while, but under the stimulus of Hilbert's school at Göttingen her interests shifted and she became one of the primary contributors to modern algebra.



Paul Albert Gordan
1837–1912

So far, we have concentrated on the reduction of the operators and carrier spaces into irreducible components. Let us now direct our attention to the vectors themselves. Given two irreducible representations $T^{(\alpha)}$ and $T^{(\beta)}$ with carrier spaces spanned by vectors $\{|\phi_i^{(\alpha)}\rangle\}_{i=1}^{n_\alpha}$ and $\{|\psi_j^{(\beta)}\rangle\}_{j=1}^{n_\beta}$, we form the direct product representation $T^{(\alpha \times \beta)}$ with the carrier space spanned by vectors $\{|\phi_i^{(\alpha)}\psi_j^{(\beta)}\rangle\}$. We know that $T^{(\alpha \times \beta)}$ is reducible, and Eq. (24.45) tells us how many times each irreducible factor occurs in $T^{(\alpha \times \beta)}$. This means that the span of $\{|\phi_i^{(\alpha)}\psi_j^{(\beta)}\rangle\}$ can be decomposed into invariant irreducible subspaces; i.e., there must exist a basis of the carrier of the product space the vectors of which belong to irreducible representations of G . More specifically, we should be able to form the linear combinations

Clebsch-Gordan
coefficients

$$|\Psi_k^{(\sigma),q}\rangle = \sum_{ij} C(\alpha\beta; \sigma, q|ij; k)|\phi_i^{(\alpha)}\psi_j^{(\beta)}\rangle, \quad (24.46)$$

which transform according to the rows of the σ th irreducible representation. Here the subscript k refers to the row of the σ th representation, and q distinguishes among functions that have the same σ and k , corresponding to the case where $m_\sigma^{\alpha\beta} \geq 2$. For simply reducible groups, the label q is unnecessary. The coefficients $C(\alpha\beta; \sigma, q|ij; k)$ are called the **Clebsch-Gordan coefficients** for G . These coefficients are normalized such that

$$\begin{aligned} \sum_{ij} C^*(\alpha\beta; \sigma, q|ij; k)C(\alpha\beta; \sigma', q'|ij; k') &= \delta_{\sigma\sigma'}\delta_{qq'}\delta_{kk'}, \\ \sum_{\sigma q k} C^*(\alpha\beta; \sigma, q|ij; k)C(\alpha\beta; \sigma, q|i'j'; k) &= \delta_{ii'}\delta_{jj'}. \end{aligned}$$

This will guarantee that $|\Psi_k^{(\sigma),q}\rangle$ are orthonormal if the product vectors form an orthonormal set. Using these relations, we can write the inverse of Eq. (24.46) as

$$|\phi_i^{(\alpha)}\psi_j^{(\beta)}\rangle = \sum_{\sigma q k} C^*(\alpha\beta; \sigma, q|ij; k)|\Psi_k^{(\sigma),q}\rangle. \quad (24.47)$$

24.8.2 Irreducible Tensor Operators

An operator \mathbf{A} acting in the carrier space of the representation of a group G is transformed into another operator, $\mathbf{A} \mapsto \mathbf{T}_g \mathbf{A} \mathbf{T}_g^{-1}$, by the action of the group. Just as in the case of vector spaces, one can thus construct a set of operators that transform among themselves by such action and lump these operators in irreducible sets.

irreducible set of operators **Definition 24.8.4** An operator $\mathbf{A}_i^{(\alpha)}$ is said to **transform according to the i th row of the α th irreducible representation** if there exist $n_\alpha - 1$ other operators $\{\mathbf{A}_j^{(\alpha)}\}$ and a basis $\{|\psi_i^{(\alpha)}\rangle\}$ such that

$$\mathbf{T}_g \mathbf{A}_i^{(\alpha)} \mathbf{T}_g^{-1} = \sum_{j=1}^{n_\alpha} T_{ji}^{(\alpha)}(g) \mathbf{A}_j^{(\alpha)}, \quad (24.48)$$

where $(T_{ji}^{(\alpha)}(g))$ is the matrix representation of g . The set of such operators is called an **irreducible set of operators** (or irreducible tensorial set).

In particular, if $T_{ij}^{(\alpha)}(g) = \delta_{ij}$, i.e., if the representation is the identity representation, then $\mathbf{A} = \mathbf{T}_g \mathbf{A} \mathbf{T}_g^{-1}$, and \mathbf{A} is called a **scalar operator**. The term “scalar” refers to the fact that \mathbf{A} has only one “component,” in contrast to the other operators of Eq. (24.48), which may possess several components.

Consider the set of vectors (functions) defined by $|\psi_{ij}^{(\alpha\beta)}\rangle \equiv \mathbf{A}_i^{(\alpha)} |\phi_j^{(\beta)}\rangle$, where $|\phi_j^{(\beta)}\rangle$ transform according to the β th irreducible representation. These vectors transform according to

$$\begin{aligned} \mathbf{T}_g |\psi_{ij}^{(\alpha\beta)}\rangle &= \mathbf{T}_g \mathbf{A}_i^{(\alpha)} \mathbf{T}_g^{-1} \mathbf{T}_g |\phi_j^{(\beta)}\rangle = \sum_{k=1}^{n_\alpha} T_{ki}^{(\alpha)}(g) \mathbf{A}_k^{(\alpha)} \sum_{l=1}^{n_\beta} T_{lj}^{(\beta)}(g) |\phi_l^{(\beta)}\rangle \\ &= \sum_{k,l} T_{ki}^{(\alpha)}(g) T_{lj}^{(\beta)}(g) \mathbf{A}_k^{(\alpha)} |\phi_l^{(\beta)}\rangle = \sum_{k,l} T_{kl,ij}^{(\alpha \times \beta)}(g) |\psi_{kl}^{(\alpha\beta)}\rangle, \end{aligned} \quad (24.49)$$

i.e., according to the representation $T^{(\alpha \times \beta)}$. This means that the vectors $|\psi_{ij}^{(\alpha\beta)}\rangle$ have the same transformation properties as the tensor product vectors $|\phi_i^{(\alpha)} \psi_j^{(\beta)}\rangle$. Therefore, using Eq. (24.47), we can write

$$\mathbf{A}_i^{(\alpha)} |\phi_j^{(\beta)}\rangle = \sum_{\sigma q k} C^*(\alpha\beta; \sigma, q | ij; k) |\Psi_k^{(\sigma), q}\rangle,$$

and more importantly,

$$\begin{aligned} \langle \phi_m^{(\gamma)} | \mathbf{A}_i^{(\alpha)} | \phi_j^{(\beta)} \rangle &= \sum_{\sigma q k} C^*(\alpha\beta; \sigma, q | ij; k) \underbrace{\langle \phi_m^{(\gamma)} | \Psi_k^{(\sigma), q} \rangle}_{\text{use Eq. (24.36) here}} \\ &= \sum_q C^*(\alpha\beta; \gamma, q | ij; m) \langle \phi_m^{(\gamma)} | \Psi_m^{(\gamma), q} \rangle. \end{aligned} \quad (24.50)$$

It follows that the matrix element of the operator $\mathbf{A}_i^{(\alpha)}$ will vanish unless the irreducible representation $T^{(\gamma)}$ occurs in the reduction of the tensor product $T^{(\alpha)} \otimes T^{(\beta)}$, and this can be decided from the character tables and the Clebsch-Gordan series, Eq. (24.45).

There is another remarkable property of Eq. (24.50) that has significant physical consequences. Notice how the dependence on i and j is contained entirely in the Clebsch-Gordan coefficients. Moreover, Eq. (24.37) implies that $\langle \phi_m^{(\gamma)} | \Psi_m^{(\gamma), q} \rangle$ is independent of m . Therefore, this dependence must also be contained entirely in Clebsch-Gordan coefficients. One therefore

Wigner–Eckart theorem
and reduced matrix
elements

writes (24.50) as

$$\langle \phi_m^{(\gamma)} | \mathbf{A}_i^{(\alpha)} | \phi_j^{(\beta)} \rangle \equiv \sum_q C^*(\alpha\beta; \gamma, q | ij; m) \underbrace{\langle \phi^{(\gamma)} | \mathbf{A}^{(\alpha)} | \phi^{(\beta)} \rangle}_q. \quad (24.51)$$

reduced matrix element

This equation is known as the **Wigner-Eckart theorem**, and the numbers multiplying the Clebsch-Gordan coefficients are known as the **reduced matrix elements**.

From the point of view of physics, Eq. (24.51) can be very useful in calculating matrix elements (expectation values and transition between states), once we know the transformation properties of the physical operator. For example, for a **scalar operator** \mathbf{S} , which, by definition, transforms according to the identity representation, (24.51) becomes

$$\langle \phi_m^{(\gamma)} | \mathbf{A} | \phi_j^{(\beta)} \rangle = \langle \phi^{(\gamma)} | \mathbf{A}^{(\alpha)} | \phi^{(\beta)} \rangle \delta_{\gamma\beta} \delta_{mj};$$

i.e., scalar operators have no matrix elements between different irreducible representations of a group, and within an irreducible representation, they are multiples of the identity matrix. This result is also a consequence of Schur's lemma.

24.9 Problems

24.1 Show that the action of a group G on the space of functions ψ given by $\mathbf{T}_g \psi(\mathbf{x}) = \psi(g^{-1} \cdot \mathbf{x})$ is a representation of G .

24.2 Complete Example 24.1.6.

24.3 Let the vector space carrying the representation of S_3 be the space of functions. Choose $\psi_1(x, y, z) \equiv xy$ and find the matrix representation of S_3 in the minimal invariant subspace containing ψ_1 . Hint: See Example 24.2.2.

24.4 Let the vector space carrying the representation of S_3 be the space of functions. Choose (a) $\psi_1(x, y, z) \equiv x$ and (b) $\psi_1(x, y, z) \equiv x^2$, and in each case, find the matrix representation of S_3 in the minimal invariant subspace containing ψ_1 .

24.5 Show that the representations T , \overline{T} , and T^* are either all reducible or all irreducible.

24.6 Use the hermitian conjugate of Eq. (24.5) to show that $\mathbf{S} \equiv \mathbf{A}^\dagger \mathbf{A}$ commutes with all \mathbf{T}_g 's. This result is used to prove Schur's lemmas in infinite dimensions.

24.7 Show that elements of a group belonging to the same conjugacy class have the same characters.

24.8 Show that the regular representation is indeed a representation, i.e., that $R : G \rightarrow GL(m, \mathbb{R})$ is a homomorphism.

Table 24.5 Character table for S_4

| | 1K_1 | 6K_2 | 3K_3 | 8K_4 | 6K_5 |
|-----------|-----------|-----------|-----------|-----------|-----------|
| $T^{(1)}$ | 1 | 1 | 1 | 1 | 1 |
| $T^{(2)}$ | 1 | -1 | 1 | 1 | -1 |
| $T^{(3)}$ | 2 | 0 | 2 | -1 | 0 |
| $T^{(4)}$ | 3 | 1 | -1 | 0 | -1 |
| $T^{(5)}$ | 3 | -1 | -1 | 0 | 1 |

24.9 Prove **Maschke's Theorem**: The group algebra is semi-simple.

24.10 Let G be a finite group. Define the element $P = \sum_{x \in G} x$ of the group algebra and show that the left ideal generated by P is one-dimensional.

24.11 Show that $\mathbf{T}_i^{(\alpha)}$ defined in Eq. (24.23) commutes with all operators $\mathbf{T}_g^{(\alpha)}$. Hint: Consider $\mathbf{T}_g^{(\alpha)} \mathbf{T}_i^{(\alpha)} (\mathbf{T}_g^{(\alpha)})^{-1}$.

24.12 Let $K_{i'}$ denote the set of inverses of a conjugacy class K_i with c_i elements.

- (a) Show that $K_{i'}$ is also a class with c_i elements.
- (b) Show that identity occurs exactly c_i times in the product $\kappa_i \kappa_{i'}$, and none in the product $\kappa_i \kappa_j$ if $j \neq i'$ [see Eq. (24.21)].
- (c) Conclude that

$$c_{ij1} = \begin{cases} 0 & \text{if } j \neq i', \\ c_i & \text{if } j = i'. \end{cases}$$

24.13 Show that the coefficients $|G|d_j/|H|c_i$ of Eq. (24.33) are integers.

24.14 Show that the symmetric and the antisymmetric representations of S_n are inequivalent.

24.15 Construct the character table for S_4 from that of S_3 (given as Table 24.4), and verify that it is given by Table 24.5.

24.16 Show that all functions transforming according to a given row of an irreducible representation have the same norm.

24.17 Show that if the group of symmetry of \mathbf{V} contains that of \mathbf{H}_0 and $|\phi_j^{(\alpha)}\rangle$ belongs to the j th column of the α th irreducible representation, then so does $\mathbf{V}|\phi_j^{(\alpha)}\rangle$. Conclude that $\langle \phi_i^{(\alpha)} | \mathbf{V} | \phi_j^{(\alpha)} \rangle = 0$ for $i \neq j$.

24.18 Find the irreducible components of the representation of Example 24.1.6.

24.19 Show that $\mathbf{P}^{(3)}|\psi_3\rangle$ of Example 24.7.4 is a linear combination of $\mathbf{P}^{(3)}|\psi_1\rangle$ and $\mathbf{P}^{(3)}|\psi_2\rangle$.

24.20 Show that the tensor product of two unitary representations is unitary.

24.21 Switch the dummy indices of the double sum in (24.43), add (subtract) the two sums, and use $(T \otimes T)_{ia,jb}(g) = (T \otimes T)_{ai,bj}(g)$ to show that the double sum can be written as a sum over the *symmetric (antisymmetric)* vectors alone.

24.22 Show that the characters $\chi^S(g)$ and $\chi^A(g)$ of the symmetrized and antisymmetrized product representations are given, respectively, by

$$\chi^S(g) = \frac{1}{2}[(\chi(g))^2 + \chi(g^2)] \quad \text{and} \quad \chi^A(g) = \frac{1}{2}[(\chi(g))^2 - \chi(g^2)].$$

24.23 Suppose that $\mathbf{A}_i^{(\alpha)}$ transforms according to $T^{(\alpha)}$, and $\mathbf{A}_j^{(\beta)}$ according to $T^{(\beta)}$. Show that $\mathbf{A}_i^{(\alpha)} \mathbf{A}_j^{(\beta)}$ transforms according to $T^{(\alpha \times \beta)}$.

24.24 Show that

$$\frac{1}{m_{\alpha\beta}} \sum_{ij} |\langle \phi_m^{(\gamma)} | \mathbf{A}_i^{(\alpha)} | \phi_j^{(\beta)} \rangle|^2 = |\langle \phi^{(\gamma)} | \mathbf{A}^{(\alpha)} | \phi^{(\beta)} \rangle_q|^2.$$

One can interpret this as the statement that the square of the reduced matrix element is proportional to the average (over i and j) of the square of the full matrix elements.

The symmetric (permutation) group is an important prototype of finite groups. In fact, **Cayley's theorem** (see [Rotm 84, p. 46] for a proof) states that any finite group of order n is isomorphic to a subgroup of S_n . Moreover, the representation of S_n leads directly to the representation of many of the Lie groups encountered in physical applications. It is, therefore worthwhile to devote some time to the analysis of the representations of S_n . Cayley's theorem

25.1 Analytic Construction

The starting point of the construction of representations of the symmetric group is Eq. (24.33), which is valid for any finite group. There is one simple character that every group has, namely, the character of the one-dimensional symmetric representation in which all elements of the group are mapped to $1 \in \mathbb{R}$. Setting $\xi_j^{(\kappa)} = 1$ in (24.33), and noting that $\sum_j d_j = d_i$, we obtain

$$\psi_i^H \equiv \frac{|G|d_i}{|H|c_i}, \tag{25.1}$$

where $\{\psi_i^H\}$ are the components of a compound character of G .

Frobenius has shown that by a clever choice of H , one can completely solve the problem of the construction of the irreducible representations of S_n . The interested reader may refer to [Hame 89, pp. 189–192] for details. We are really interested in the simple characters of S_n , and Frobenius came up with a powerful method of calculating them. Since there is a one-to-one correspondence between the irreducible representations and conjugacy classes, and another one between conjugacy classes of S_n and partitions of n , we shall label the simple characters of S_n by partitions of n . Thus, instead of our common notation $\chi_i^{(\alpha)}$, we use $\chi_{(l)}^{(\lambda)}$, where (λ) denotes a partition of n , and (l) a cycle structure of S_n .

Suppose we want to find the irreducible characters corresponding to the cycle structure $(l) = (1^\alpha, 2^\beta, 3^\gamma, \dots)$. These form a *column* under the class (l) in a character table. To calculate the irreducible characters, form two polynomials in (x_1, x_2, \dots, x_n) as follows. The first one, which is com-

pletely symmetric in all variables, is

$$s_{(l)} \equiv \left(\sum_{i=1}^n x_i \right)^\alpha \left(\sum_{i=1}^n x_i^2 \right)^\beta \left(\sum_{i=1}^n x_i^3 \right)^\gamma \cdots \tag{25.2}$$

The second one is completely antisymmetric, and can be written as

$$D(x_1, \dots, x_n) \equiv \prod_{i < j} (x_i - x_j) = \sum_{\pi} \epsilon_{\pi} x_{\pi(1)}^{n-1} x_{\pi(2)}^{n-2} \cdots x_{\pi(n-1)} x_{\pi(n)}^0. \tag{25.3}$$

It can be shown that the simple characters of S_n are coefficients of certain terms of the product of these polynomials. To be exact, we have

$$\begin{aligned} s_{(l)} D(x_1, \dots, x_n) &= \sum_{(\lambda)} \chi_{(l)}^{(\lambda)} \sum_{\pi} \epsilon_{\pi} x_{\pi(1)}^{\lambda_1+n-1} x_{\pi(2)}^{\lambda_2+n-2} \cdots x_{\pi(n-1)}^{\lambda_{n-1}+1} x_{\pi(n)}^{\lambda_n}. \end{aligned} \tag{25.4}$$

The outer sum goes over all partitions of n , the inner sum over all permutations of S_n . The procedure for finding the simple characters of S_n should now be clear from (25.4):

Proposition 25.1.1 *To find the simple character $\chi_{(1^{\alpha} 2^{\beta} \dots)}^{(\lambda_1 \dots \lambda_n)}$, construct the corresponding symmetric and antisymmetric polynomials of (25.2) and (25.3), multiply them together, collect all terms of the form*

$$x_1^{\lambda_1+n-1} x_2^{\lambda_2+n-2} \cdots x_{n-1}^{\lambda_{n-1}+1} x_n^{\lambda_n}.$$

The coefficient of such a term is the desired character.

Example 25.1.2 The best way to understand the procedure described above is to go through an example in detail. We calculate the characters of S_3 using the above method. Label the rows of the character table with the partitions of 3. These are (3), (2, 1), and (1, 1, 1). Similarly, label the columns with the conjugacy classes, or cycle structures: (1³), (1, 2), and (3). The first cycle structure has $\alpha = 3, \beta = 0 = \gamma$. Therefore,

$$\begin{aligned} s_{(1^3)} &= (x_1 + x_2 + x_3)^3 = x_1^3 + x_2^3 + x_3^3 \\ &\quad + 3(x_1^2 x_2 + x_1^2 x_3 + x_1 x_2^2 + x_2^2 x_3 + x_1 x_3^2 + x_2 x_3^2) + 6x_1 x_2 x_3 \end{aligned} \tag{25.5}$$

and

$$\begin{aligned} D(x_1, x_2, x_3) &= (x_1 - x_2)(x_1 - x_3)(x_2 - x_3) \\ &= x_1^2 x_2 - x_1^2 x_3 - x_2^2 x_1 + x_2^2 x_3 - x_3^2 x_2 + x_3^2 x_1. \end{aligned} \tag{25.6}$$

Now we note that for $(\lambda) = (3)$, $\lambda_1 = 3$, $\lambda_2 = 0$, and $\lambda_3 = 0$. Therefore, the coefficient of $x_1^{\lambda_1+n-1} x_2^{\lambda_2+n-2} \cdots x_n^{\lambda_n} = x_1^5 x_2$ gives $\chi_{(1^3)}^{(3)}$. Similarly, for $(\lambda) = (2, 1, 0)$, $\lambda_1 = 2$, $\lambda_2 = 1$, and $\lambda_3 = 0$, and the coefficient of $x_1^{\lambda_1+n-1} x_2^{\lambda_2+n-2} \cdots x_n^{\lambda_n} = x_1^4 x_2^2$ gives $\chi_{(1^3)}^{(2,1)}$. Finally, for $(\lambda) = (1, 1, 1)$, $\lambda_1 = \lambda_2 = \lambda_3 = 1$, and the coefficient of $x_1^{\lambda_1+n-1} x_2^{\lambda_2+n-2} \cdots x_n^{\lambda_n} = x_1^3 x_2^2 x_3$ gives $\chi_{(1^3)}^{(1,1,1)}$. These coefficients can be read off by scanning through Eq. (25.5) while multiplying its terms by those of Eq. (25.6) and keeping track of the coefficients of the products of the relevant powers of x_1 , x_2 , and x_3 . The reader may verify that there is only one term of the form $x_1^5 x_2$, whose coefficient is 1, giving $\chi_{(1^3)}^{(3)} = 1$; there are two terms of the form $x_1^4 x_2^2$, whose coefficients are -1 and 3 , giving $\chi_{(1^3)}^{(2,1)} = 2$; and there are four terms of the form $x_1^3 x_2^2 x_3$, whose coefficients are $+1$, -3 , -3 , and $+6$, giving $\chi_{(1^3)}^{(1,1,1)} = 1$. Therefore, the first column of the character table of S_3 is $\begin{pmatrix} 1 \\ 2 \\ 1 \end{pmatrix}$.

To obtain the second column, we consider the second conjugacy class, $(1, 2)$, with $\alpha = 1 = \beta$ and $\gamma = 0$. The corresponding symmetric polynomial is

$$\begin{aligned} s_{(1,2)} &= (x_1 + x_2 + x_3)(x_1^2 + x_2^2 + x_3^2) \\ &= x_1^3 + x_2^3 + x_3^3 + x_1^2 x_2 + x_1^2 x_3 + x_1 x_2^2 + x_2 x_3^2 + x_1 x_3^2 + x_2 x_3^2. \end{aligned} \tag{25.7}$$

$D(x_1, x_2, x_3)$ is the same as before. Multiplying and keeping track of the coefficients of $x_1^5 x_2$, $x_1^4 x_2^2$, and $x_1^3 x_2^2 x_3$, we obtain $\chi_{(1,2)}^{(3)} = 1$, $\chi_{(1,2)}^{(2,1)} = 0$, and $\chi_{(1,2)}^{(1,1,1)} = -1$. It follows that the second column of the character table of S_3 is $\begin{pmatrix} 1 \\ 0 \\ -1 \end{pmatrix}$.

The last column is obtained similarly. We note that $\alpha = 0 = \beta$, and $\gamma = 1$. Therefore, the symmetric polynomial is

$$s_{(3)} = x_1^3 + x_2^3 + x_3^3,$$

and the antisymmetric polynomial is the same as before. Multiplying these two polynomials and extracting the coefficients as before, we get $\chi_{(3)}^{(3)} = 1$, $\chi_{(3)}^{(2,1)} = -1$, and $\chi_{(3)}^{(1,1,1)} = 1$. It follows that the third column of the character table of S_3 is $\begin{pmatrix} 1 \\ -1 \\ 1 \end{pmatrix}$.

Collecting all the data obtained above, we can reconstruct the character table of S_3 . This is shown in Table 25.1. The irreducible representations are labeled by the three possible partitions of 3, and the conjugacy classes by the three cycle structures.

Table 25.1 The character table for S_3 . Each column corresponds to a conjugacy class, each row to a partition of 3. The last two rows have been switched compared to Table 24.4

| | (1^3) | $(1, 2)$ | (3) |
|---------------|---------|----------|-------|
| $T^{(3)}$ | 1 | 1 | 1 |
| $T^{(2,1)}$ | 2 | 0 | -1 |
| $T^{(1,1,1)}$ | 1 | -1 | 1 |

25.2 Graphical Construction

The analytic construction of the previous subsection can be handled using graphical techniques that are considerably simpler. To begin with, let us find the character of the identity element of S_n . The cycle structure is (1^n) , i.e., all cycles consist of a single element. Thus, $\alpha = n$, and β, γ , etc. are all zero. It follows that the LHS of Eq. (25.4) is $(\sum x_i)^n D(x_j)$. We calculate this product one power of $\sum x_i$ at a time. For the same reason as in the example above, $\chi_{(1^n)}^{(\lambda)}$ will be the coefficient of

$$x_1^{\lambda_1+n-1} x_2^{\lambda_2+n-2} \dots x_{n-1}^{\lambda_{n-1}+1} x_n^{\lambda_n}.$$

Historical Notes

Ferdinand Georg Frobenius (1849–1917), the son of a parson, was born in Berlin and began his mathematical studies at Göttingen in 1867. He received his doctorate in Berlin three years later. Four years later, on the basis of his mathematical research, he was appointed assistant professor at the University of Berlin. He achieved the rank of full professor at the *Eidgenössische Polytechnikum Zürich* before returning to Berlin as a professor of mathematics in 1892. During the early years of Frobenius’s career, modern group theory was in its infancy. He combined its three main branches of study—the theory of solutions to algebraic equations (permutation groups and the work of Galois), geometry (transformation and Lie groups), and number theory—to produce the concept of the abstract group. He collaborated with Issai Schur in representation and character theory of groups.



Ferdinand Georg Frobenius 1849–1917

His paper *Über die Gruppencharactere* is of fundamental importance. It was presented to the Berlin Academy on 16 July 1896 and it contains work that Frobenius had done in the preceding few months. In a series of letters to Dedekind, the first on 12 April 1896, his ideas on group characters quickly develop, and Frobenius is able to construct a complete set of representations by complex numbers. In a letter to Dedekind on 26 April 1896 Frobenius finds the irreducible characters for the alternating group, and the symmetric groups.

In 1897 Frobenius reformulated the work of Molien—the Latvian student of Klein, who, in his thesis, classified the semi-simple algebras using the method of group rings—in terms of matrices and then showed that his characters are the traces of the irreducible representations. Frobenius’s character theory found important applications in quantum mechanics and was used with great effect by Burnside, who wrote it up in the 1911 edition of his *Theory of Groups of Finite Order*.

Frobenius is also remembered as the originator of a series method for solving ordinary differential equations. Despite the clearly greater importance of his work in group theory, this *method of Frobenius* serves admirably to perpetuate his name.

If we multiply $D(x_j)$ by $\sum x_i$ one x at a time, we increase the power of one of the x_i ’s by one. If at any stage, two of the exponents become equal, the term must vanish, due to the antisymmetry of $(\sum x_i)D(x_j)$. Therefore, as we raise the degree of the polynomial by one at each stage, the power of x_1 must be raised at least as fast as x_2 , and the power of x_2 must be raised at

least as fast as x_3 , etc. Our goal is to raise the power of x_1 by λ_1 , that of x_2 by λ_2 , and, in general, the power of x_i by λ_i , making sure that at each stage, the number of multiplications by x_1 is greater than or equal to the number of multiplications by x_2 , etc. The total number of ways by which we can reach this goal will be $\chi_{(1^n)}^{(\lambda)}$, which is also the dimension of the irreducible representation (λ) by Eq. (24.9).

To see the argument more clearly, suppose that we are interested in the dimension of the irreducible representation of S_4 corresponding to $(3, 1)$. Then we must raise the power of x_1 by 3 and the power of x_2 by 1; x_3 and x_4 will remain intact, and therefore will not enter in the following discussion. It follows that $D(x_j)$ is to be multiplied by $x_1^3 x_2$, one x -factor at a time, the number of x_1 -factors always exceeding the number of x_2 -factors. The possible ways of doing this are

$$x_1^3 x_2, \quad x_1^2 x_2 x_1, \quad x_1 x_2 x_1^2. \tag{25.8}$$

Note that as we count the factors from left to right, the number of x_1 's is always greater than or equal to the number of x_2 's. Thus $x_2 x_1^3$ is absent because x_2 occurs without x_1 occurring first. It follows that the dimension of the irreducible representation $(3, 1)$ is 3.

A graphical way to arrive at the same result is to draw $\lambda_1 = 3$ boxes on top and $\lambda_2 = 1$ box below it:

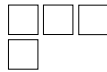

The next step is to fill in the boxes with numbers corresponding to the position of x_1 (filling up the first row) and x_2 factors (filling up the second row) in Eq. (25.8). Since in the first term of (25.8), the x_1 's occupy the first, second, and third positions, we enter 1, 2, and 3 in the first row, and 4 in the second row corresponding to the last position occupied by x_2 . Similarly, in the second term of (25.8), the x_1 's occupy the first, second, and fourth positions; therefore, we enter 1, 2, and 4 in the first row, and 3 in the second row corresponding to the position occupied by x_2 . Finally, in the last term of (25.8), the x_1 's occupy the first, third, and fourth positions; therefore, we enter 1, 3, and 4 in the first row, and 2 in the second row corresponding to the position occupied by x_2 . The result is the graph shown below:

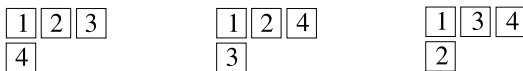

Young frame defined

Definition 25.2.1 Let $(\lambda) = (\lambda_1, \lambda_2, \dots, \lambda_n)$ be a partition of n . The **Young frame** (or the **Young pattern**) associated with (λ) is a collection of rows of boxes (squares) aligned at the left such that the first row has λ_1 boxes, the second row λ_2 boxes, etc. Since $\lambda_i \geq \lambda_{i+1}$, the length of the rows decreases as one goes to the bottom of the frame.

The Young frame associated with (λ) represents $x_1^{\lambda_1} \cdots x_n^{\lambda_n}$, which multiplies the antisymmetric polynomial $D(x_j)$. To find the dimension of the irreducible representation $T^{(\lambda)}$, we have to count the number of ways in which the x -factors can be permuted among themselves such that as we scan the product, the number of x_i 's is never less than number of x_j 's if $j > i$. This leads to

standard Young tableaux defined **Definition 25.2.2** A **standard Young tableau** (or diagram, or graph) is a Young frame filled with numbers 1 through n such that

1. the numbers are placed consecutively left to right on the rows starting with 1 in the far-left box of the first row;
2. no box of any row is to be filled unless all boxes to its left are already filled;
3. at each stage, the number of boxes filled in any row is never less than the number of boxes filled in the rows below it.

regular graphs Tableaux satisfying the last condition are called **regular graphs**.

It follows that in a Young tableau, the number 1 is always in the upper left-hand box, and that going down in a column, the numbers must increase.

Theorem 25.2.3 *Let (λ) be a partition of n . Then the dimension of the irreducible representation $T^{(\lambda)}$ is equal to the number of standard Young tableaux associated with (λ) .*

Example 25.2.4 We wish to calculate the dimension of each irreducible representation of S_4 . The partitions are (4) , $(3, 1)$, $(2, 2)$, $(2, 1, 1)$, and $(1, 1, 1, 1)$ whose associated Young frames are shown below:

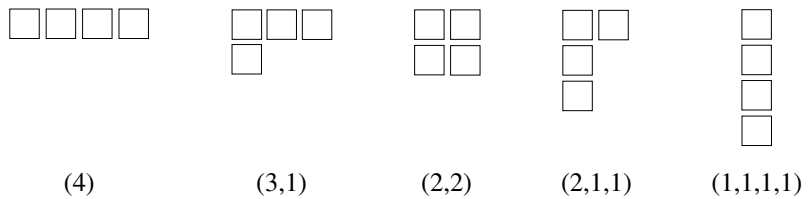

The number of standard Young tableaux associated with $(\lambda) = (4)$ is 1, because there is only one way to place the numbers 1 through 4 in the four boxes. Thus, the dimension of $T^{(4)}$ is 1. For $(\lambda) = (3, 1)$, we can place 2 either to the right of 1 or below it. The first choice gives rise to two possibilities for the placement of 3: Either to the right of 2 or below 1. The second choice gives rise to only one possibility for 3, namely to the right of 1. With 1, 2, and 3 in place, the position of 4 is predetermined. Thus, we have 3 possibilities for $(\lambda) = (3, 1)$, and the dimension of $T^{(3,1)}$ is 3. For $(\lambda) = (2, 2)$, we can place 2 either to the right of 1 or below it. Both choices give rise to only one possibility for 3: In the first case, 3 can only go under 1; in the

| | | | | |
|-----------|---|---|---|---------------------|
| (4) | $\begin{array}{ c c c c } \hline 1 & 2 & 3 & 4 \\ \hline \end{array}$ | | $n_{(4)} = 1$ | |
| (3,1) | $\begin{array}{ c c c } \hline 1 & 2 & 3 \\ \hline 4 \\ \hline \end{array}$ | $\begin{array}{ c c c } \hline 1 & 3 & 4 \\ \hline 2 \\ \hline \end{array}$ | $\begin{array}{ c c c } \hline 1 & 2 & 4 \\ \hline 3 \\ \hline \end{array}$ | $n_{(3,1)} = 3$ |
| (2,2) | $\begin{array}{ c c } \hline 1 & 2 \\ \hline 3 & 4 \\ \hline \end{array}$ | $\begin{array}{ c c } \hline 1 & 3 \\ \hline 2 & 4 \\ \hline \end{array}$ | | $n_{(2,2)} = 2$ |
| (2,1,1) | $\begin{array}{ c c } \hline 1 & 2 \\ \hline 3 & \\ \hline 4 & \\ \hline \end{array}$ | $\begin{array}{ c c } \hline 1 & 4 \\ \hline 2 & \\ \hline 3 & \\ \hline \end{array}$ | $\begin{array}{ c c } \hline 1 & 3 \\ \hline 2 & \\ \hline 4 & \\ \hline \end{array}$ | $n_{(2,1,1)} = 3$ |
| (1,1,1,1) | $\begin{array}{ c } \hline 1 \\ \hline 2 \\ \hline 3 \\ \hline 4 \\ \hline \end{array}$ | | | $n_{(1,1,1,1)} = 1$ |

Fig. 25.1 The standard Young tableaux, and the dimensions of irreducible representations of S_4

second case to its right. With 1, 2, and 3 in place, the position of 4 is again predetermined. Thus, we have 2 possibilities for $(\lambda) = (2, 2)$, and the dimension of $T^{(3,1)}$ is 2. The reader may check that the dimension of $T^{(2,1,1)}$ is 3, and that of $T^{(1,1,1,1)}$ is 1. Figure 25.1 summarizes these findings. We note that the dimensions satisfy $1^2 + 3^2 + 2^2 + 3^2 + 1^2 = 24$, the second equation of (24.18).

25.3 Graphical Construction of Characters

The product of the symmetric polynomial $s_{(l)}$ and the antisymmetric polynomial $D(x_j)$ contains all the information regarding the representations of S_n . We can extract the simple characters by looking at the coefficients of appropriate products of the x -factors. This can also be done graphically. Without going into the combinatorics of the derivation of the results, we state the rules for calculating the simple characters, and examine one particular case in detail to elucidate the procedure, whose statement can be very confusing.

As before, we label the irreducible representations with the partitions of n . However, we separate out the common factors in a cyclic structure, labeling the cycles by l_1, l_2 , etc. For example, $(2, 1^2)$ has $l_1 = 2, l_2 = 1$, and $l_3 = 1$. So, $(2, 1^2)$ becomes $(2, 1, 1)$, and in general, we write (l) as (l_1, l_2, \dots, l_m) .

Definition 25.3.1 A **regular application** of r identical symbols to a Young frame is the placement of those symbols in the boxes of the frame as follows. Add the symbols to any given row, starting with the first (farthest to the left) unoccupied cell, until the symbols are all used or the number of filled boxes exceeds that of the preceding line by one. In the latter case, go to the regular application

preceding line and repeat the procedure, making sure that the final result of adding all r symbols will be a regular graph. If the number of rows occupied by the symbols is odd (even) the application is **positive (negative)**.

As an illustration, consider the regular application of five 2's to the blank Young frame shown below.

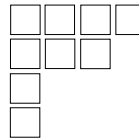

We cannot start on the first row because it does not have enough boxes for the five 2's. We can start on the second row and put one 2 in the first box. This brings the number of 2's in the second row to one more than in the first row; therefore, we should now go to the first row and put the rest of the symbols there. We could start at the third row, put one 2 in the first box, put a second 2 in the first box of the second row, and the rest in the first row. Altogether we will have 3 regular applications of the five 2's. These are shown in the diagram below.

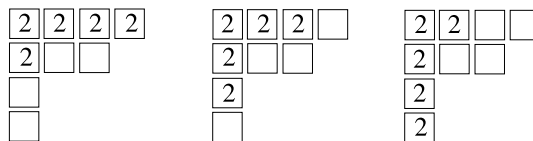

Of these the first and the last tableaux are negative applications, and the middle one is positive.

Theorem 25.3.2 *The character of the irreducible representation $T^{(\lambda)}$ of the class $(l) = (l_1, l_2, \dots, l_m)$ is obtained by successive regular applications of l_1 identical symbols (usually taken to be 1's), then l_2 identical symbols of a different kind (usually taken to be 2's), etc. The character $\chi_{(l)}^{(\lambda)}$ is then equal to the number of ways of building positive applications minus the number of ways of building negative applications.*

The order in which the l_i 's are applied is irrelevant. However, it is usually convenient to start with the largest cycle.

The best way to understand the procedure is to construct a character table. Let us do this for S_4 . As usual, the rows are labeled by the various partitions (λ) of 4. We choose the order (4) , $(3, 1)$, $(2, 2) = (2^2)$, $(2, 1, 1) = (2, 1^2)$, $(1, 1, 1, 1) = (1^4)$. The columns are labeled by classes (l) in the following order: (1^4) , $(2, 1^2)$, (2^2) , $(3, 1)$, (4) , where, for example, $(2, 1^2)$ means that $l_1 = 2$, $l_2 = 1$, and $l_3 = 1$. Example 25.2.4 gives us the first column of the character table. Similarly, the first row has 1 in all places, because it is the

Detailed analysis of the construction of the character table for S_4

trivial representation. Our task is therefore to fill in the rest of the table one row at a time. The second row, with $(\lambda) = (3, 1)$, has a Young frame that looks like

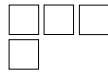

and for each class (column) labeled (l_1, \dots, l_m) , we need to fill this in with l_1 identical symbols (1's), l_2 identical symbols of a different kind (2's), etc.

The second column has $l_1 = 2, l_2 = 1 = l_3$. So we have two 1's, one 2, and one 3. If we start with the first row, the two 1's can be placed in its first two boxes. If we start with the second row, the two 1's must be placed vertically on top of each other. In the first case, we have two choices for the 2: Either on the first row next to the two 1's, or on the second line. In the second case, we have only one choice for the 2: in the first row next to 1. With 1's and 2 in place, the position of 3 is determined. The three possibilities are shown below:

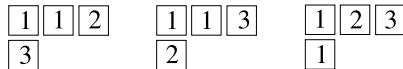

The first two are positive applications, the third is negative because the 1's occupy an even number of rows. We therefore have

$$\chi_{(2,1^2)}^{(3,1)} = +1 + 1 - 1 = +1.$$

The third column has $l_1 = 2 = l_2$. So we have two 1's and two 2's. We place the 1's as before. When the two 1's are placed vertically, we can put the 2's on the first row and we are done. When the 1's are initially placed in the first row, we have no way of placing the 2's by regular application. We cannot start on the first row because there is only one spot available (remember, we cannot go down once we start at a row). We cannot start on the second row because once we place the first 2, we are blocked, and the number of symbols in the second row does not exceed that of the first row by one. So, there is only one possibility:

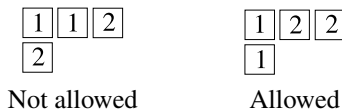

The only allowed diagram is obtained by a negative application of 1's. Therefore, $\chi_{(2^2)}^{(3,1)} = -1$.

The fourth column has $l_1 = 3$ and $l_2 = 1$. So we have three 1's and one 2. There are two ways to place the 1's: all on the first row, or starting on the second row and working our way up until all boxes are filled except the last box of the first row. The placement of 2 will be then predetermined. The result is the two diagrams shown below:

Table 25.2 Character table for S_4 . The rows and columns are labeled by the partitions of 4 and cycle structures, respectively

| | (1^4) | $(2, 1^2)$ | (2^2) | $(3, 1)$ | (4) |
|---------------|---------|------------|---------|----------|-------|
| $T^{(4)}$ | 1 | 1 | 1 | 1 | 1 |
| $T^{(3,1)}$ | 3 | 1 | -1 | 0 | -1 |
| $T^{(2^2)}$ | 2 | 0 | 2 | -1 | 0 |
| $T^{(2,1^2)}$ | 3 | -1 | -1 | 0 | 1 |
| $T^{(1^4)}$ | 1 | -1 | 1 | 1 | -1 |



The first diagram is obtained by a positive application of 1's, the second by a negative application. Therefore,

$$\chi_{(3,1)}^{(3,1)} = +1 - 1 = 0.$$

Finally, for the last column, $l_1 = 4$. There is only one way to put all the 1's in the frame, and that is a negative application. Thus, $\chi_{(4)}^{(3,1)} = -1$.

Rather than going through the rest of the table in the same gory detail, we shall point out some of the trickier calculations, and leave the rest of the table for the reader to fill in. One confusion may arise in the calculation of $\chi_{(2^2)}^{(2^2)}$. The frame looks like this,



and we need to fill this with two 1's and two 2's. The 1's can go into the first row or the first column. The 2's then can be placed in the second row or the second column. The result is

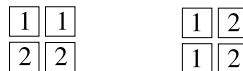

The first diagram has no negative application. The second has *two* negative applications, one for the 1's, and one for the 2's. Therefore, the overall sign for the second diagram is positive. It follows that $\chi_{(2^2)}^{(2^2)} = +1 + 1 = +2$.

The calculation of $\chi_{(4)}^{(2^2)}$ may also be confusing. We need to place four 1's in the frame. If we start on the first row, we are stuck, because there is room for only two 1's. If we start in the second row, then we can only go up: Putting the first 1 in the second row causes that row to have one extra 1 in comparison with the preceding row. However, once we go up, we have room for only two 1's (we cannot go back down). So, there is no way we can place the four 1's in the (2^2) frame, and $\chi_{(4)}^{(2^2)} = 0$.

The character table for S_4 is shown in Table 25.2 (see Problem 24.15 as well). The reader is urged to verify all entries not calculated above. The

Table 25.3 Character table for S_5 . The rows and columns are labeled by the partitions of 5 and cycle structures, respectively

| | (1^5) | $(2, 1^3)$ | $(2^2, 1)$ | $(3, 2)$ | $(3, 1^2)$ | $(4, 1)$ | (5) |
|---------------|---------|------------|------------|----------|------------|----------|-------|
| $T^{(5)}$ | 1 | 1 | 1 | 1 | 1 | 1 | 1 |
| $T^{(4,1)}$ | 4 | 2 | 0 | -1 | 1 | 0 | -1 |
| $T^{(3,2)}$ | 5 | 1 | 1 | 1 | -1 | -1 | 0 |
| $T^{(3,1^2)}$ | 6 | 0 | -2 | 0 | 0 | 0 | 1 |
| $T^{(2^2,1)}$ | 5 | -1 | 1 | -1 | -1 | 1 | 0 |
| $T^{(2,1^3)}$ | 4 | -2 | 0 | 1 | 1 | 0 | -1 |
| $T^{(1^5)}$ | 1 | -1 | 1 | -1 | 1 | -1 | 1 |

character table for S_5 can also be calculated with only minor tedium. We quote the result here in Table 25.3 and let the reader check the entries of the table.

25.4 Young Operators

The group algebra techniques of Sect. 24.5—which we used in our discussion of representation theory in a very limited way—provide a powerful and elegant tool for unraveling the representations of finite groups. These techniques have been particularly useful in the analysis of the representations of the symmetric group. Our emphasis on the symmetric group is not merely due to the importance of S_n as a paradigm of all finite groups. It has also to do with the unexpected usefulness of the representations of S_n in studying the representations of $GL(V)$, the paradigm of all (classical) *continuous* groups. We shall come back to this observation later when we discuss representations of Lie groups in Chap. 30.

To begin with, consider the element of the S_n group algebra as defined in Eq. (24.20). Since multiplying P (on the left) by a group element does not change P , the ideal generated by P is not only one-dimensional, but all elements of S_n are represented by the number 1. Therefore, the ideal $\mathcal{A}P$ corresponds to the (irreducible) identity representation.

For S_n , there is another group algebra element that has similar properties. This is

$$Q = \sum_{i=1}^{n!} \epsilon_{\pi_i} \pi_i, \quad \pi_i \in S_n. \tag{25.9}$$

The reader may check that

$$\pi_j Q = \epsilon_{\pi_j} Q \quad \text{and} \quad Q^2 = n!Q.$$

As in the case of P , Q generates a one-dimensional ideal, but a left multiplication may introduce a minus sign (when the permutation is odd). Thus, the ideal generated by Q must correspond to the antisymmetric (or alternating) representation.

All the irreducible representations, including the special one-dimensional cases above, can be obtained using this group-algebraic method. We shall not give the proofs here, and we refer the reader to the classic book [Boer 63, pp. 102–125]. The starting point is the Young frame corresponding to the partition $(\lambda) = (\lambda_1, \dots, \lambda_m)$. One puts the numbers 1 through n in the frame in *any* order, consistent with tableau construction, so that the end product is a Young tableau. Let p be any permutation of a Young tableau that permutes only the elements of each row among themselves. Such a p is called a **horizontal permutation**. Similarly, let q be a **vertical permutation** of the Young tableau.

Definition 25.4.1 Consider the k th Young tableau corresponding to the partition (λ) . Let the **Young symmetrizer** $P_k^{(\lambda)}$ and **Young antisymmetrizer** $Q_k^{(\lambda)}$ be the elements of the group algebra of S_n defined as

$$P_k^{(\lambda)} = \sum_p P, \quad Q_k^{(\lambda)} = \sum_q \epsilon_q q.$$

Then, the **Young operator** $Y_k^{(\lambda)}$ of this tableau, another element of the group algebra, is given by $Y_k^{(\lambda)} = Q_k^{(\lambda)} P_k^{(\lambda)}$.

It can be shown that the following holds.

Theorem 25.4.2 *The Young operator $Y_k^{(\lambda)}$ is essentially idempotent, and generates a minimal left ideal, hence an irreducible representation for S_n . Representations thus obtained from different frames are inequivalent. Different tableaux with the same frame give equivalent irreducible representations.*

In practice, one usually chooses the standard Young tableaux and applies the foregoing procedure to them to obtain the entire collection of inequivalent irreducible representations of S_n . We have already seen how to calculate characters of S_n employing both analytical and graphical methods. Theorem 25.4.2 gives yet another approach to analyzing representations of S_n . For low values of n this technique may actually be used to determine the characters, but as n grows, it becomes unwieldy, and the graphical method becomes more manageable.

Example 25.4.3 Let us apply this method to S_3 . The partitions are (3) , $(2, 1)$, and (1^3) . There is only one standard Young tableau associated with (3) and (1^3) . Thus,

$$Y^{(3)} = P^{(3)} = \frac{1}{3!} \sum_{j=1}^6 \pi_j = \frac{1}{6} (e + \pi_2 + \pi_3 + \pi_4 + \pi_5 + \pi_6),$$

$$Y^{(1^3)} = Q^{(1^3)} = \frac{1}{3!} \sum_{j=1}^6 \epsilon_{\pi_j} \pi_j = \frac{1}{6} (e - \pi_2 - \pi_3 - \pi_4 + \pi_5 + \pi_6),$$

where we have divided these Young operators by 6 to make them idempotent; we have also used the notation of Example 23.4.1. One can show directly that $Y^{(3)}Y^{(1^3)} = 0$. In fact, one can prove this for general S_n (see Problem 25.6).

For the partition (2, 1), there are two Young tableaux. The first one has the numbers 1 and 2 in the first row and 3 in the second. In the second tableau the numbers 2 and 3 are switched. Therefore, using the multiplication table for S_3 as given in Example 23.4.1, we have

$$\begin{aligned} Y_1^{(2,1)} &= Q_1^{(2,1)} P_1^{(2,1)} = (e - \pi_3)(e + \pi_2) = e + \pi_2 - \pi_3 - \pi_6, \\ Y_2^{(2,1)} &= Q_2^{(2,1)} P_2^{(2,1)} = (e - \pi_2)(e + \pi_3) = e - \pi_2 + \pi_3 - \pi_5. \end{aligned}$$

The reader may verify that the product of any two Young operators corresponding to different Young tableaux is zero and that

$$Y_1^{(2,1)} Y_1^{(2,1)} = 3Y_1^{(2,1)}, \quad Y_2^{(2,1)} Y_2^{(2,1)} = 3Y_2^{(2,1)}.$$

Let us calculate the left ideal generated by these four Young operators. We already know from our discussion at the beginning of this subsection that $\mathcal{L}^{(3)}$ and $\mathcal{L}^{(1^3)}$, the ideals generated by $Y^{(3)}$ and $Y^{(1^3)}$, are one-dimensional. Let us find $\mathcal{L}_1^{(2,1)}$, the ideal generated by $Y_1^{(2,1)}$. This is the span of all vectors obtained by multiplying $Y_1^{(2,1)}$ on the left by elements of the group algebra. It is sufficient to multiply $Y_1^{(2,1)}$ by the basis of the algebra, namely the group elements:

$$\begin{aligned} eY_1^{(2,1)} &= Y_1^{(2,1)}, \\ \pi_2 Y_1^{(2,1)} &= \pi_2 + e - \pi_5 - \pi_4 \equiv X_1^{(2,1)}, \\ \pi_3 Y_1^{(2,1)} &= \pi_3 + \pi_6 - e - \pi_2 = -Y_1^{(2,1)}, \\ \pi_4 Y_1^{(2,1)} &= \pi_4 + \pi_5 - \pi_6 - \pi_3 = -X_1^{(2,1)} + Y_1^{(2,1)}, \\ \pi_5 Y_1^{(2,1)} &= \pi_5 + \pi_4 - \pi_2 - e = -X_1^{(2,1)}, \\ \pi_6 Y_1^{(2,1)} &= \pi_6 + \pi_3 - \pi_4 - \pi_5 = X_1^{(2,1)} - Y_1^{(2,1)}. \end{aligned}$$

It follows from the above calculation that $\mathcal{L}_1^{(2,1)}$, as a vector space, is spanned by $\{Y_1^{(2,1)}, X_1^{(2,1)}\}$, and since these two vectors are linearly independent, $\mathcal{L}_1^{(2,1)}$ is a two-dimensional minimal ideal corresponding to a two-dimensional irreducible representation of S_3 . One can use this basis to find representation matrices and the simple characters of S_3 .

The other two-dimensional irreducible representation of S_3 , *equivalent* to the one above, is obtained by constructing the ideal $\mathcal{L}_2^{(2,1)}$ generated by $Y_2^{(2,1)}$. This construction is left for the reader, who is also asked to verify its dimensionality.

The resolution of the identity is easily verified:

$$e = \underbrace{\frac{1}{6}Y^{(3)}}_{\equiv e_1} + \underbrace{\frac{1}{6}Y^{(1^3)}}_{\equiv e_2} + \underbrace{\frac{1}{3}Y_1^{(2,1)}}_{\equiv e_3} + \underbrace{\frac{1}{3}Y_2^{(2,1)}}_{\equiv e_4}.$$

The e_i 's are idempotents that satisfy $e_i e_j = 0$ for $i \neq j$.

25.5 Products of Representations of S_n

In the quantum theory of systems of many *identical* particles, the wave function must have a particular symmetry under exchange of the particles: If the particles are all fermions (bosons), the overall wave function must be completely antisymmetric (symmetric). Since the space of functions of several variables can provide a carrier space for the representation of any group, we can, in the case of S_n , think of the antisymmetric (symmetric) functions as basis functions for the one-dimensional irreducible identity (alternating) representation. To obtain these basis functions, we apply the Young operator $Y^{(1^n)}$ (or $Y^{(n)}$) to the arguments of any given function of n variables to obtain the completely antisymmetric (or symmetric) wave function.¹

Under certain conditions, we may require mixed symmetries. For instance, in the presence of spin, the product of the total spin wave function and the total space wave function must be completely antisymmetric for Fermions. Thus, the space part (or the spin part) of the wave functions will, in general, have mixed symmetry. Such a mixed symmetry corresponds to some other Young operator, and the wave function is obtained by applying that Young operator to the arguments of the wave function.

Now suppose that we have two separate systems consisting of n_1 and n_2 particles, respectively, which are all assumed to be identical. As long as the two systems are not interacting, each will consist of states that are classified according to the irreducible representations of its symmetric group. When the two systems interact, we should classify the states of the total system according to the irreducible representations of all $n_1 + n_2$ particles. We have already encountered the mathematical procedure for such classification: It is the Clebsch-Gordan decomposition of the direct product of the states of the two systems. Since the initial states correspond to Young tableaux, and since we are interested in the inequivalent irreducible representations, we need to examine the decomposition of the direct product of Young frames into a sum of Young frames. We first state (without proof) the procedure for such a decomposition, and then give an example to illustrate it.

Theorem 25.5.1 *To find the components of Young frames in the product of two Young frames, draw one of the frames. In the other frame, assign the same symbol, say 1, to all boxes in the first row, the same symbol 2 to all*

¹We must make the additional assumption that the permuted functions are all independent.

boxes in the second row, etc. Now attach the first row to the first frame, and enlarge in all possible ways subject to the restriction that no two 1's appear in the same column, and that the resultant graph be regular. Repeat with the 2's, etc., making sure in each step that as we read from right to left and top to bottom, no symbol is counted fewer times than the symbol that came after it. The product is the sum of all diagrams so obtained.

To illustrate the procedure, consider the product

$$\begin{array}{|c|c|} \hline \square & \square \\ \hline \square & \\ \hline \end{array} \otimes \begin{array}{|c|c|} \hline 1 & 1 \\ \hline 2 & \\ \hline \end{array}$$

We have put two 1's in the first row and one 2 in the second row of the frame to the right. Now apply the first row to the frame on the left. The result is

$$\begin{array}{|c|c|c|c|} \hline \square & \square & 1 & 1 \\ \hline \square & & & \\ \hline \end{array} \quad \begin{array}{|c|c|c|} \hline \square & \square & 1 \\ \hline \square & 1 & \\ \hline \end{array} \quad \begin{array}{|c|c|c|} \hline \square & \square & 1 \\ \hline \square & & \\ \hline 1 & & \\ \hline \end{array} \quad \begin{array}{|c|c|} \hline \square & \square \\ \hline \square & 1 \\ \hline 1 & \\ \hline \end{array}$$

Now we apply the 2 to each of these graphs separately. We cannot put a 2 to the right of the 1's, because in that case, as we count from right to left, we would start with a 2 without having counted any 1's. The allowed graphs obtained from the first diagram are

$$\begin{array}{|c|c|c|c|} \hline \square & \square & 1 & 1 \\ \hline \square & 2 & & \\ \hline \end{array} \quad \begin{array}{|c|c|c|c|} \hline \square & \square & 1 & 1 \\ \hline \square & & & \\ \hline 2 & & & \\ \hline \end{array}$$

Applying the 2 to the second graph, we obtain

$$\begin{array}{|c|c|c|} \hline \square & \square & 1 \\ \hline \square & 1 & 2 \\ \hline \end{array} \quad \begin{array}{|c|c|c|} \hline \square & \square & 1 \\ \hline \square & 1 & \\ \hline 2 & & \\ \hline \end{array}$$

and to the third graph gives

$$\begin{array}{|c|c|c|} \hline \square & \square & 1 \\ \hline \square & 2 & \\ \hline 1 & & \\ \hline \end{array} \quad \begin{array}{|c|c|c|} \hline \square & \square & 1 \\ \hline \square & & \\ \hline 1 & & \\ \hline 2 & & \\ \hline \end{array}$$

Finally the last graph yields

$$\begin{array}{|c|c|} \hline \square & \square \\ \hline \square & 1 \\ \hline 1 & 2 \\ \hline \end{array} \quad \begin{array}{|c|c|} \hline \square & \square \\ \hline \square & 1 \\ \hline 1 & \\ \hline 2 & \\ \hline \end{array}$$

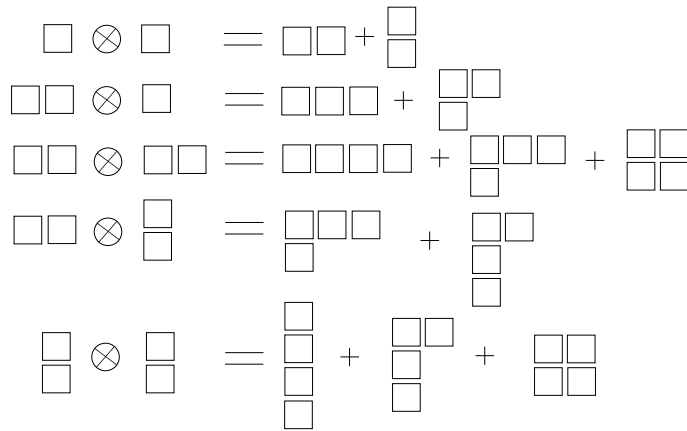
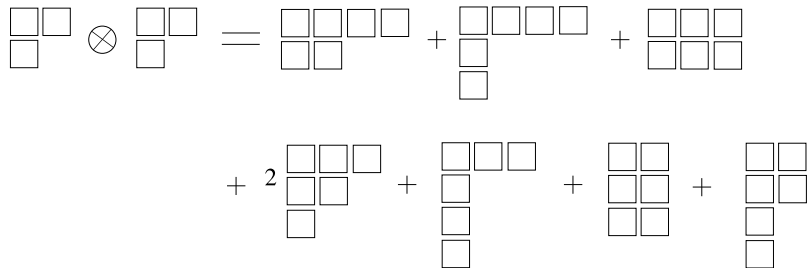

Fig. 25.2 Some products of Young frames for small values of n

The entire process described above is written in terms of frames as



Some simple products, some of which will be used later, are given in Fig. 25.2.

25.6 Problems

25.1 Construct the character table of S_4 using the analytical method and Eq. (25.4).

25.2 Find all the standard Young tableaux for S_5 . Thus, determine the dimension of each irreducible representations of S_5 . Check that the dimensions satisfy the second equation of (24.18).

25.3 Verify the remaining entries of Table 25.2.

25.4 Construct the character table of S_5 .

25.5 Suppose that Q , an element of the group algebra of S_n , is given by

$$Q = \sum_{i=1}^{n!} \epsilon_{\pi_i} \pi_i, \quad \pi_i \in S_n.$$

Show that

$$\pi_j Q = \epsilon_{\pi_j} Q \quad \text{and} \quad Q^2 = n!Q.$$

25.6 Show that $Y^{(n)}Y^{(1^n)} = 0$. Hint: There are as many even permutations in S_n as there are odd permutations.

25.7 Show that the product of any two Young operators of S_3 corresponding to different Young tableaux is zero and that

$$Y_1^{(2,1)}Y_1^{(2,1)} = 3Y_1^{(2,1)}, \quad Y_2^{(2,1)}Y_2^{(2,1)} = 3Y_2^{(2,1)}.$$

25.8 Construct the ideal $\mathcal{L}_2^{(2,1)}$ generated by $Y_2^{(2,1)}$ and verify that it is two dimensional.

25.9 Using the ideal $\mathcal{L}_1^{(2,1)}$ generated by $Y_1^{(2,1)}$, find the matrices of the irreducible representation $T^{(2,1)}$. From these matrices calculate the simple characters of S_3 and compare your result with Table 24.4. Show that the ideal $\mathcal{L}_2^{(2,1)}$ generated by $Y_2^{(2,1)}$ gives the same set of characters.

25.10 Find all the Young operators for S_4 corresponding to the first entry of each row of Fig. 25.1. Find the ideals $\mathcal{L}_1^{(3,1)}$ and $\mathcal{L}_1^{(2^2)}$ generated by the Young operators $Y_1^{(3,1)}$ and $Y_1^{(2^2)}$ corresponding to the second and third rows of the table. Show that $\mathcal{L}_1^{(3,1)}$ and $\mathcal{L}_1^{(2^2)}$ have 3 and 2 dimensions, respectively.

25.11 Verify the products of the Young frames of Fig. 25.2.

Part VIII
Tensors and Manifolds

Until around 1970s, tensors were almost completely synonymous with (general) relativity except for a minor use in hydrodynamics. Students of physics did not need to study tensors until they took a course in the general theory of relativity. Then they would read the introductory chapter on tensor algebra and analysis, solve a few problems to condition themselves for index “gymnastics”, read through the book, learn some basic facts about relativity, and finally abandon it (unless they became relativists).

Today, with the advent of gauge theories of fundamental particles, the realization that gauge fields are to be thought of as geometrical objects, and the widespread belief that all fundamental interactions (including gravity) are different manifestations of the same superforce, the picture has changed drastically.

Two important developments have taken place as a consequence: Tensors have crept into other interactions besides gravity (such as the weak and strong nuclear interactions), and the geometrical (coordinate-independent) aspects of tensors have become more and more significant in the study of all interactions. The coordinate-independent study of tensors is the focus of the fascinating field of differential geometry and Lie groups, the subject of the remainder of the book.

As is customary, we will consider only real vector spaces and abandon the Dirac bra and ket notation, whose implementation is most advantageous in unitary (complex) spaces. From here on, the basis vectors¹ of a vector space \mathcal{V} will be distinguished by a subscript and those of its dual space by a superscript. If $\{\mathbf{e}_i\}_{i=1}^N$ is a basis in \mathcal{V} , then $\{\mathbf{e}^j\}_{j=1}^N$ is a basis in \mathcal{V}^* . Also, **Einstein’s summation convention** will be used:

Einstein’s summation convention

Box 26.0.1 *Repeated indices, of which one is an upper and the other a lower index, are assumed to be summed over: $a_i^k b_j^i$ means $\sum_{i=1}^N a_i^k b_j^i$.*

¹We denote vectors by roman boldface, and tensors of higher rank by sans serif bold letters.

As a result of this convention, it is more natural to label the elements of a matrix representation of an operator \mathbf{A} by α_i^j (rather than α_{ji}), because then $\mathbf{A}\mathbf{e}_i = \alpha_i^j \mathbf{e}_j$.

26.1 Tensors as Multilinear Maps

Since tensors are special kinds of linear operators on vector spaces, let us reconsider $\mathcal{L}(\mathcal{V}, \mathcal{W})$, the space of all linear mappings from the real vector space \mathcal{V} to the real vector space \mathcal{W} . We noted in Chap. 5 that $\mathcal{L}(\mathcal{V}, \mathcal{W})$ is isomorphic to a space with dimension $\dim \mathcal{V} \cdot \dim \mathcal{W}$. The following proposition—whose proof we leave to the reader—shows this directly.

Proposition 26.1.1 *Let $\{\mathbf{e}_i\}_{i=1}^{N_1}$ be a basis for \mathcal{V} and $\{\mathbf{e}'_\alpha\}_{\alpha=1}^{N_2}$ a basis for \mathcal{W} . Then*

1. *the linear transformations $\mathbf{T}_\beta^j : \mathcal{V} \rightarrow \mathcal{W}$ in the vector space $\mathcal{L}(\mathcal{V}, \mathcal{W})$, defined by (note the new way of writing the Kronecker delta)*

$$\mathbf{T}_\beta^j \mathbf{e}_i = \delta_i^j \mathbf{e}'_\beta, \quad j = 1, \dots, N_1; \quad \beta = 1, \dots, N_2, \quad (26.1)$$

form a basis in $\mathcal{L}(\mathcal{V}, \mathcal{W})$. In particular, $\dim \mathcal{L}(\mathcal{V}, \mathcal{W}) = N_1 N_2$.

2. *If τ_j^α are the matrix elements of a matrix representation of a linear transformation $\mathbf{T} \in \mathcal{L}(\mathcal{V}, \mathcal{W})$ with respect to the two bases above, then $\mathbf{T} = \tau_j^\alpha \mathbf{T}_\alpha^j$.*

The dual space \mathcal{V}^* is simply the space $\mathcal{L}(\mathcal{V}, \mathbb{R})$. Proposition 26.1.1 (with $N_2 = 1$) then implies that $\dim \mathcal{V}^* = \dim \mathcal{V}$, which was shown in Chap. 2. The dual space is important in the discussion of tensors, so we consider some of its properties below.

When $\mathcal{W} = \mathbb{R}$, the basis $\{\mathbf{T}_\beta^j\}$ of Proposition 26.1.1 reduces to $\{\mathbf{T}_1^j\}$ and is denoted by $\{\boldsymbol{\epsilon}^j\}_{j=1}^N$, with $N = \dim \mathcal{V}^* = \dim \mathcal{V}$. The $\boldsymbol{\epsilon}^j$'s have the property that

$$\boldsymbol{\epsilon}^j(\mathbf{e}_i) = \delta_i^j, \quad (26.2)$$

which is (26.1) with $\beta = 1$ and $\mathbf{e}'_\beta = \mathbf{e}'_1 = 1$, a basis of \mathbb{R} . Equation (26.2) was also established in Chap. 2. The basis $B^* = \{\boldsymbol{\epsilon}^j\}_{j=1}^N$ is simply the dual of the basis $B = \{\mathbf{e}_i\}_{i=1}^N$. Note the “natural” position of the indices for B and B^* .

Now suppose that $\{\mathbf{f}_i\}_{i=1}^N = B'$ is another basis of \mathcal{V} and \mathbf{R} is the (invertible) matrix carrying B onto B' . Let $B'^* = \{\boldsymbol{\varphi}^j\}_{j=1}^N$ be the dual of B' . We want to find the matrix that carries B^* onto B'^* . If we denote this matrix by \mathbf{A} and its elements by a_i^j , we have

$$\delta_i^k = \boldsymbol{\varphi}^k \mathbf{f}_i = (a_i^l \boldsymbol{\epsilon}^l)(r_i^j \mathbf{e}_j) = a_i^k r_i^j \delta_j^l = a_i^k r_i^l = (\mathbf{A}\mathbf{R})_i^k,$$

where the first equality follows from the duality of B' and B'^* . In matrix form, this equation can be written as $\mathbf{A}\mathbf{R} = \mathbf{1}$, or $\mathbf{A} = \mathbf{R}^{-1}$. Thus,

Box 26.1.2 *The matrix that transforms bases of \mathcal{V}^* is the inverse of the matrix that transforms the corresponding bases of \mathcal{V} .*

In the equations above, the upper index in matrix elements labels *rows*, and the lower index labels *columns*. This can be remembered by noting that the column vectors \mathbf{e}_i can be thought of as columns of a matrix, and the lower index i then labels those columns. Similarly, \mathbf{e}^j can be thought of as rows of a matrix. We now generalize the concept of linear functionals.

Definition 26.1.3 A map $\mathbf{T} : \mathcal{V}_1 \times \mathcal{V}_2 \times \dots \times \mathcal{V}_r \rightarrow \mathcal{W}$ is called *r-linear* if it is linear in all its variables:

$$\begin{aligned} \mathbf{T}(\mathbf{v}_1, \dots, \alpha \mathbf{v}_i + \alpha' \mathbf{v}'_i, \dots, \mathbf{v}_r) \\ = \alpha \mathbf{T}(\mathbf{v}_1, \dots, \mathbf{v}_i, \dots, \mathbf{v}_r) + \alpha' \mathbf{T}(\mathbf{v}_1, \dots, \mathbf{v}'_i, \dots, \mathbf{v}_r) \end{aligned}$$

multilinear mappings
defined

for all i .

We can easily construct a bilinear map. Let $\boldsymbol{\tau}_1 \in \mathcal{V}_1^*$ and $\boldsymbol{\tau}_2 \in \mathcal{V}_2^*$. We define the map $\boldsymbol{\tau}_1 \otimes \boldsymbol{\tau}_2 : \mathcal{V}_1 \times \mathcal{V}_2 \rightarrow \mathbb{R}$ by

$$\boldsymbol{\tau}_1 \otimes \boldsymbol{\tau}_2(\mathbf{v}_1, \mathbf{v}_2) = \boldsymbol{\tau}_1(\mathbf{v}_1)\boldsymbol{\tau}_2(\mathbf{v}_2). \tag{26.3}$$

The expression $\boldsymbol{\tau}_1 \otimes \boldsymbol{\tau}_2$ is called the **tensor product** of $\boldsymbol{\tau}_1$ and $\boldsymbol{\tau}_2$. Clearly, since $\boldsymbol{\tau}_1$ and $\boldsymbol{\tau}_2$ are separately linear, so is $\boldsymbol{\tau}_1 \otimes \boldsymbol{\tau}_2$.

An r -linear map can be multiplied by a scalar, and two r -linear maps can be added; in each case the result is an r -linear map. Thus, the set of r -linear maps from $\mathcal{V}_1 \times \dots \times \mathcal{V}_r$ into \mathcal{W} forms a vector space that is denoted by $\mathcal{L}(\mathcal{V}_1, \dots, \mathcal{V}_r; \mathcal{W})$.

We can also construct multilinear maps on the dual space. First, we note that we can define a natural linear functional on \mathcal{V}^* as follows. We let $\boldsymbol{\tau} \in \mathcal{V}^*$ and $\mathbf{v} \in \mathcal{V}$; then $\boldsymbol{\tau}(\mathbf{v}) \in \mathbb{R}$. Now we twist this around and *define* a mapping $\mathbf{v} : \mathcal{V}^* \rightarrow \mathbb{R}$ given by $\mathbf{v}(\boldsymbol{\tau}) \equiv \boldsymbol{\tau}(\mathbf{v})$. It is easily shown that this mapping is linear. Thus, we have naturally constructed a linear functional on \mathcal{V}^* by identifying $(\mathcal{V}^*)^*$ with \mathcal{V} .

Construction of multilinear maps on \mathcal{V}^* is now trivial. For example, let $\mathbf{v}_1 \in \mathcal{V}_1$ and $\mathbf{v}_2 \in \mathcal{V}_2$ and define the tensor product $\mathbf{v}_1 \otimes \mathbf{v}_2 : \mathcal{V}_1^* \times \mathcal{V}_2^* \rightarrow \mathbb{R}$ by

$$\mathbf{v}_1 \otimes \mathbf{v}_2(\boldsymbol{\tau}_1, \boldsymbol{\tau}_2) = \mathbf{v}_1(\boldsymbol{\tau}_1)\mathbf{v}_2(\boldsymbol{\tau}_2) = \boldsymbol{\tau}_1(\mathbf{v}_1)\boldsymbol{\tau}_2(\mathbf{v}_2). \tag{26.4}$$

We can also construct mixed multilinear maps such as $\mathbf{v} \otimes \boldsymbol{\tau} : \mathcal{V}^* \times \mathcal{V} \rightarrow \mathbb{R}$ given by

$$\mathbf{v} \otimes \boldsymbol{\tau}(\boldsymbol{\theta}, \mathbf{u}) = \mathbf{v}(\boldsymbol{\theta})\boldsymbol{\tau}(\mathbf{u}) = \boldsymbol{\theta}(\mathbf{v})\boldsymbol{\tau}(\mathbf{u}). \tag{26.5}$$

There is a bilinear map $\mathbf{h} : \mathcal{V}^* \times \mathcal{V} \rightarrow \mathbb{R}$ that naturally pairs \mathcal{V} and \mathcal{V}^* ; it is given by $\mathbf{h}(\boldsymbol{\theta}, \mathbf{v}) \equiv \boldsymbol{\theta}(\mathbf{v})$. This mapping is called the **natural pairing** of \mathcal{V} and \mathcal{V}^* into \mathbb{R} and is denoted by using angle brackets:

natural pairing of vectors
and their duals

$$\mathbf{h}(\boldsymbol{\theta}, \mathbf{v}) \equiv \langle \boldsymbol{\theta}, \mathbf{v} \rangle \equiv \boldsymbol{\theta}(\mathbf{v}).$$

tensors; covariant and contravariant degrees

Definition 26.1.4 Let \mathcal{V} be a vector space with dual space \mathcal{V}^* . Then a **tensor of type** (r, s) is a multilinear mapping

$$\mathbf{T}_s^r : \underbrace{\mathcal{V}^* \times \mathcal{V}^* \times \cdots \times \mathcal{V}^*}_{r \text{ times}} \times \underbrace{\mathcal{V} \times \mathcal{V} \times \cdots \times \mathcal{V}}_{s \text{ times}} \rightarrow \mathbb{R}.$$

The set of all such mappings for fixed r and s forms a vector space denoted by $\mathcal{T}_s^r(\mathcal{V})$. The number r is called the **contravariant degree** of the tensor, and s is called the **covariant degree** of the tensor.

As an example, let $\mathbf{v}_1, \dots, \mathbf{v}_r \in \mathcal{V}$ and $\boldsymbol{\tau}^1, \dots, \boldsymbol{\tau}^s \in \mathcal{V}^*$, and define the tensor product $\mathbf{T}_s^r \equiv \mathbf{v}_1 \otimes \cdots \otimes \mathbf{v}_r \otimes \boldsymbol{\tau}^1 \otimes \cdots \otimes \boldsymbol{\tau}^s$ by

$$\begin{aligned} & \mathbf{v}_1 \otimes \cdots \otimes \mathbf{v}_r \otimes \boldsymbol{\tau}^1 \otimes \cdots \otimes \boldsymbol{\tau}^s(\boldsymbol{\theta}^1, \dots, \boldsymbol{\theta}^r, \mathbf{u}_1, \dots, \mathbf{u}_s) \\ &= \mathbf{v}_1(\boldsymbol{\theta}^1) \cdots \mathbf{v}_r(\boldsymbol{\theta}^r) \boldsymbol{\tau}^1(\mathbf{u}_1) \cdots \boldsymbol{\tau}^s(\mathbf{u}_s) = \prod_{i=1}^r \prod_{j=1}^s \boldsymbol{\theta}^i(\mathbf{v}_i) \boldsymbol{\tau}^j(\mathbf{u}_j). \end{aligned}$$

Each \mathbf{v} in the tensor product requires an element of \mathcal{V}^* ; that is why the number of factors of \mathcal{V}^* in the Cartesian product equals the number of \mathbf{v} 's in the tensor product. As explained in Chap. 1, the Cartesian product with s factors of \mathcal{V} is denoted by \mathcal{V}^s (similarly for \mathcal{V}^*).

contravariant and covariant vectors and tensors

A tensor of type $(0, 0)$ is defined to be a scalar, so $\mathcal{T}_0^0(\mathcal{V}) = \mathbb{R}$. A tensor of type $(1, 0)$, an ordinary vector, is called a **contravariant vector**, and one of type $(0, 1)$, a dual vector (or a linear functional), is called a **covariant vector**. A tensor of type $(r, 0)$ is called a **contravariant tensor** of rank r , and one of type $(0, s)$ is called a **covariant tensor** of rank s . The union of $\mathcal{T}_s^r(\mathcal{V})$ for all possible r and s can be made into an (infinite-dimensional) algebra, called the **algebra of tensors**, by defining the following product on it:

tensors form an algebra

multiplication of the algebra of tensors

Definition 26.1.5 The **tensor product** of a tensor \mathbf{T} of type (r, s) and a tensor \mathbf{U} of type (k, l) is a tensor $\mathbf{T} \otimes \mathbf{U}$ of type $(r+k, s+l)$, defined, as an operator on $(\mathcal{V}^*)^{r+k} \times \mathcal{V}^{s+l}$, by

$$\begin{aligned} & \mathbf{T} \otimes \mathbf{U}(\boldsymbol{\theta}^1, \dots, \boldsymbol{\theta}^{r+k}, \mathbf{u}_1, \dots, \mathbf{u}_{s+l}) \\ &= \mathbf{T}(\boldsymbol{\theta}^1, \dots, \boldsymbol{\theta}^r, \mathbf{u}_1, \dots, \mathbf{u}_s) \mathbf{U}(\boldsymbol{\theta}^{r+1}, \dots, \boldsymbol{\theta}^{r+k}, \mathbf{u}_{s+1}, \dots, \mathbf{u}_{s+l}). \end{aligned}$$

This product turns the (infinite-dimensional) vector space of all tensors into an associative algebra called a **tensor algebra**.

This definition is a generalization of Eqs. (26.3), (26.4), and (26.5). It is easily verified that the tensor product is associative and distributive (over tensor addition), *but not commutative*.

Making computations with tensors requires choosing a basis for \mathcal{V} and one for \mathcal{V}^* and representing the tensors in terms of numbers (components). This process is not, of course, new. Linear operators are represented by arrays of numbers, i.e., matrices. The case of tensors is merely a generalization of that of linear operators and can be stated as follows:

Theorem 26.1.6 Let $\{\mathbf{e}_i\}_{i=1}^N$ be a basis in \mathcal{V} , and $\{\boldsymbol{\epsilon}^j\}_{j=1}^N$ a basis in \mathcal{V}^* , usually taken to be the dual of $\{\mathbf{e}_i\}_{i=1}^N$. Then the set of all tensor products $\mathbf{e}_{i_1} \otimes \dots \otimes \mathbf{e}_{i_r} \otimes \boldsymbol{\epsilon}^{j_1} \otimes \dots \otimes \boldsymbol{\epsilon}^{j_s}$ forms a basis for $\mathcal{T}_s^r(\mathcal{V})$. Furthermore, the components of any tensor $\mathbf{A} \in \mathcal{T}_s^r(\mathcal{V})$ are

$$A_{i_1 \dots i_s}^{j_1 \dots j_r} = \mathbf{A}(\boldsymbol{\epsilon}^{j_1}, \dots, \boldsymbol{\epsilon}^{j_r}, \mathbf{e}_{i_1}, \dots, \mathbf{e}_{i_s}).$$

Proof The proof is a simple exercise in employing the definition of tensor products and keeping track of the multilinear property of tensors. Details are left for the reader. \square

A useful result of the theorem is the relation

$$\mathbf{A} = A_{j_1 \dots j_s}^{i_1 \dots i_r} \mathbf{e}_{i_1} \otimes \dots \otimes \mathbf{e}_{i_r} \otimes \boldsymbol{\epsilon}^{j_1} \otimes \dots \otimes \boldsymbol{\epsilon}^{j_s}. \tag{26.6}$$

Note that for every factor in the basis vectors of $\mathcal{T}_s^r(\mathcal{V})$ there are N possibilities, each one giving a new linearly independent vector of the basis. Thus, the number of possible tensor products is N^{r+s} , and we have $\dim \mathcal{T}_s^r(\mathcal{V}) = (\dim \mathcal{V})^{r+s}$.

Example 26.1.7 Let us consider the special case of $\mathcal{T}_1^1(\mathcal{V})$ as an illustration. We can write $\mathbf{A} \in \mathcal{T}_1^1(\mathcal{V})$ as $\mathbf{A} = A_j^i \mathbf{e}_i \otimes \boldsymbol{\epsilon}^j$. Given any $\mathbf{v} \in \mathcal{V}$, we obtain²

$$\mathbf{A}(\mathbf{v}) = (A_j^i \mathbf{e}_i \otimes \boldsymbol{\epsilon}^j)(\mathbf{v}) = A_j^i \mathbf{e}_i \underbrace{[\boldsymbol{\epsilon}^j(\mathbf{v})]}_{\in \mathbb{R}}.$$

This shows that $\mathbf{A}(\mathbf{v}) \in \mathcal{V}$ and \mathbf{A} can be interpreted as a linear operator on \mathcal{V} , i.e., $\mathbf{A} \in \mathcal{L}(\mathcal{V})$. Similarly, for $\boldsymbol{\tau} \in \mathcal{V}^*$ we get

$$\mathbf{A}(\boldsymbol{\tau}) = (A_j^i \mathbf{e}_i \otimes \boldsymbol{\epsilon}^j)(\boldsymbol{\tau}) = A_j^i \underbrace{[\mathbf{e}_i(\boldsymbol{\tau})]}_{\in \mathbb{R}} \boldsymbol{\epsilon}^j.$$

$\mathcal{T}_1^1(\mathcal{V})$, $\mathcal{L}(\mathcal{V})$, and $\mathcal{L}(\mathcal{V}^*)$ are all the same

Thus, $\mathbf{A} \in \mathcal{L}(\mathcal{V}^*)$. We have shown that given $\mathbf{A} \in \mathcal{T}_1^1(\mathcal{V})$, there corresponds a linear operator belonging to $\mathcal{L}(\mathcal{V})$ [or $\mathcal{L}(\mathcal{V}^*)$] having a natural relation to \mathbf{A} . Similarly, given any $\mathbf{A} \in \mathcal{L}(\mathcal{V})$ [or $\mathcal{L}(\mathcal{V}^*)$] with a matrix representation in the basis $\{\mathbf{e}_i\}_{i=1}^N$ of \mathcal{V} (or $\{\boldsymbol{\epsilon}^j\}_{j=1}^N$ of \mathcal{V}^*) given by A_j^i , then corresponding to it in a natural way is a tensor in $\mathcal{T}_1^1(\mathcal{V})$, namely $A_j^i \mathbf{e}_i \otimes \boldsymbol{\epsilon}^j$. Problem 26.5 shows that the tensor defined in this way is basis-independent. Therefore, there is a natural one-to-one correspondence among $\mathcal{T}_1^1(\mathcal{V})$, $\mathcal{L}(\mathcal{V})$, and $\mathcal{L}(\mathcal{V}^*)$. This natural correspondence is called a **natural isomorphism**. Whenever there is a natural isomorphism between two vector spaces, those vector spaces can be treated as being the same.

natural isomorphism

²Here, we are assuming that \mathbf{A} acts on an object (such as \mathbf{v}) by “pairing it up” with an appropriate factor of which \mathbf{A} is composed (such as $\boldsymbol{\epsilon}^j$).

We have defined tensors as multilinear machines that take in a vector from a *specific* Cartesian product space of \mathcal{V} 's and \mathcal{V}^* 's and manufacture a real number. Given the representation in Eq. (26.6), however, we can generalize the interpretation of a tensor as a linear machine so that it takes a vector belonging to a Cartesian product space and manufactures a tensor. This corresponds to a situation in which not all factors of (26.6) find “partners.” An illustration of this situation was presented in the preceding example. To clarify this, let us consider $\mathbf{A} \in \mathcal{T}_2^1(\mathcal{V})$, given by

$$\mathbf{A} = A_{jk}^i \mathbf{e}_i \otimes \boldsymbol{\epsilon}^j \otimes \boldsymbol{\epsilon}^k.$$

This machine needs a Cartesian-product vector of the form $(\boldsymbol{\tau}, \mathbf{v}_1, \mathbf{v}_2)$, with $\boldsymbol{\tau} \in \mathcal{V}^*$ and $\mathbf{v}_1, \mathbf{v}_2 \in \mathcal{V}$, to give a real number. However, if it is not fed enough, it will not complete its job. For instance, if we feed it only a dual vector $\boldsymbol{\tau} \in \mathcal{V}^*$, it will give a tensor belonging to $\mathcal{T}_2^0(\mathcal{V})$:

$$\mathbf{A}(\boldsymbol{\tau}) = (A_{jk}^i \mathbf{e}_i \otimes \boldsymbol{\epsilon}^j \otimes \boldsymbol{\epsilon}^k)(\boldsymbol{\tau}) = A_{jk}^i [\mathbf{e}_i(\boldsymbol{\tau})] \boldsymbol{\epsilon}^j \otimes \boldsymbol{\epsilon}^k.$$

If we feed it a double vector $(\mathbf{v}_1, \mathbf{v}_2)$, it will manufacture a vector in \mathcal{V} :

$$\mathbf{A}(\mathbf{v}_1, \mathbf{v}_2) = (A_{jk}^i \mathbf{e}_i \otimes \boldsymbol{\epsilon}^j \otimes \boldsymbol{\epsilon}^k)(\mathbf{v}_1, \mathbf{v}_2) = A_{jk}^i \mathbf{e}_i [\boldsymbol{\epsilon}^j(\mathbf{v}_1)] [\boldsymbol{\epsilon}^k(\mathbf{v}_2)] \in \mathcal{V}.$$

positioning of vectors
and their duals to match
the tensor

What if we feed it a single vector \mathbf{v} ? It will blow its whistles and buzz its buzzers, because it does not know whether to give \mathbf{v} to $\boldsymbol{\epsilon}^j$ or $\boldsymbol{\epsilon}^k$ (it is smart enough to know that it cannot give \mathbf{v} to \mathbf{e}_i). That is why we have to inform the machine with which factor of $\boldsymbol{\epsilon}$ to match \mathbf{v} . This is done by properly positioning \mathbf{v} inside a pair of parentheses: If we write $(\cdot, \mathbf{v}, \cdot)$, the machine will know that \mathbf{v} belongs to $\boldsymbol{\epsilon}^j$, and $(\cdot, \cdot, \mathbf{v})$ tells the machine to pair \mathbf{v} with $\boldsymbol{\epsilon}^k$. If we write $(\mathbf{v}, \cdot, \cdot)$, the machine will give us an “error message” because it cannot pair \mathbf{v} with \mathbf{e}_i !

The components of a tensor \mathbf{A} , as given in Eq. (26.6), depend on the basis in which they are described. If the basis is changed, the components change. The relation between components of a tensor in different bases is called the **transformation law** for that particular tensor. Let us investigate this concept.

We use overbars to distinguish among various bases. For instance, $B = \{\mathbf{e}_i\}_{i=1}^N$, $\overline{B} = \{\overline{\mathbf{e}}_j\}_{j=1}^N$, and $\overline{\overline{B}} = \{\overline{\overline{\mathbf{e}}}_k\}_{k=1}^N$ are three different bases of \mathcal{V} . Similarly, $B^* = \{\boldsymbol{\epsilon}^i\}_{i=1}^N$, $\overline{B}^* = \{\overline{\boldsymbol{\epsilon}}^j\}_{j=1}^N$, and $\overline{\overline{B}}^* = \{\overline{\overline{\boldsymbol{\epsilon}}}_k\}_{k=1}^N$ are bases of \mathcal{V}^* . The components are also distinguished with overbars. Recall that if \mathbf{R} is the matrix connecting B and \overline{B} , then $\mathbf{S} = \mathbf{R}^{-1}$ connects B^* and \overline{B}^* . For a tensor \mathbf{A} of type (1, 2), Theorem 26.1.6 gives

$$\begin{aligned} \overline{\overline{A}}_{jk}^i &= \mathbf{A}(\overline{\boldsymbol{\epsilon}}^i, \overline{\mathbf{e}}_j, \overline{\mathbf{e}}_k) = \mathbf{A}(s_m^i \boldsymbol{\epsilon}^m, r_j^n \mathbf{e}_n, r_k^p \mathbf{e}_p) \\ &= s_m^i r_j^n r_k^p \mathbf{A}(\boldsymbol{\epsilon}^m, \mathbf{e}_n, \mathbf{e}_p) = s_m^i r_j^n r_k^p A_{np}^m. \end{aligned} \quad (26.7)$$

This is the law that transforms the components of \mathbf{A} from one basis to another.

In the classical coordinate-dependent treatment of tensors, Eq. (26.7) was the *defining* relation for a tensor of type (1, 2). In other words, a tensor of type (1, 2) was defined to be a collection of numbers, A_{np}^m that transformed to another collection of numbers \bar{A}_{jk}^i according to the rule in (26.7) when the basis was changed. In the modern treatment of tensors it is not necessary to introduce any basis to define tensors. Only when the components of a tensor are needed must bases be introduced. The advantage of the coordinate-free treatment is obvious, since a (1, 2)-type tensor has 27 components in three dimensions and 64 components in four dimensions, and all of these are represented by the single symbol \mathbf{A} . However, the role of components should not be downplayed. After all, when it comes to actual calculations, we are forced to choose a basis and manipulate components.

Since $\mathcal{T}_s^r(\mathcal{V})$ are vector spaces, it is desirable to investigate mappings from one such space to another. We will be particularly interested in linear mappings. For example, $\mathbf{f}: \mathcal{T}_0^1(\mathcal{V}) \rightarrow \mathcal{T}_0^0(\mathcal{V}) = \mathbb{R}$ is what was called a linear functional before. Similarly, $\mathbf{t}: \mathcal{T}_0^1(\mathcal{V}) \rightarrow \mathcal{T}_0^1(\mathcal{V})$ is a linear transformation on \mathcal{V} . A special linear transformation is $\text{tr}: \mathcal{T}_1^1(\mathcal{V}) \rightarrow \mathcal{T}_0^0(\mathcal{V}) = \mathbb{R}$, given by

$$\text{tr } \mathbf{A} = \text{tr}(A_j^i \mathbf{e}_i \otimes \boldsymbol{\epsilon}^j) \equiv A_i^i \equiv \sum_{i=1}^N A_i^i.$$

This is the same trace encountered in the study of linear transformations in Chap. 5.

Although the above definition of the trace makes explicit use of components with respect to a basis, it was shown in Chap. 5 that it is in fact basis-independent (see also Problem 26.7). Functions of tensors that do not depend on bases are called **invariants**. Another example of an invariant is a linear functional (see Problem 26.6).

Example 26.1.8 Consider the tensor $\mathbf{A} \in \mathcal{T}_0^2(\mathcal{V})$ given by $\mathbf{A} = \mathbf{e}_1 \otimes \mathbf{e}_1 + \mathbf{e}_2 \otimes \mathbf{e}_1$. We calculate the analogue of the trace for \mathbf{A} : $\sum_{i=1}^2 A_{ii} = 1 + 0 = 1$. Now we change to a new basis, $\{\bar{\mathbf{e}}_1, \bar{\mathbf{e}}_2\}$, given by $\mathbf{e}_1 = \bar{\mathbf{e}}_1 + 2\bar{\mathbf{e}}_2$ and $\mathbf{e}_2 = -\bar{\mathbf{e}}_1 + \bar{\mathbf{e}}_2$. In terms of the new basis vectors, \mathbf{A} is given by

$$\begin{aligned} \mathbf{A} &= (\bar{\mathbf{e}}_1 + 2\bar{\mathbf{e}}_2) \otimes (\bar{\mathbf{e}}_1 + 2\bar{\mathbf{e}}_2) + (-\bar{\mathbf{e}}_1 + \bar{\mathbf{e}}_2) \otimes (\bar{\mathbf{e}}_1 + 2\bar{\mathbf{e}}_2) \\ &= 3\bar{\mathbf{e}}_2 \otimes \bar{\mathbf{e}}_1 + 6\bar{\mathbf{e}}_2 \otimes \bar{\mathbf{e}}_2 \end{aligned}$$

with $\sum_{i=1}^2 \bar{A}_{ii} = 0 + 6 = 6 \neq \sum_{i=1}^2 A_{ii}$. This kind of “trace” is not invariant.

Besides mappings of the form $h: \mathcal{T}_s^r(\mathcal{V}) \rightarrow \mathcal{T}_l^k(\mathcal{V})$ that depend on a single variable, we can define mappings that depend on several variables, in other words, that take several elements of $\mathcal{T}_s^r(\mathcal{V})$ and give an element of $\mathcal{T}_l^k(\mathcal{V})$. We then write $h: (\mathcal{T}_s^r(\mathcal{V}))^m \rightarrow \mathcal{T}_l^k(\mathcal{V})$. It is understood that $h(\mathbf{t}_1, \dots, \mathbf{t}_m)$, in which all \mathbf{t}_i are in $\mathcal{T}_s^r(\mathcal{V})$, is a tensor of type (k, l) . If h is linear in all of its variables, it is called a **tensor-valued** multilinear map. Furthermore, if $h(\mathbf{t}_1, \dots, \mathbf{t}_m)$ does not depend on the choice of a basis of $\mathcal{T}_s^r(\mathcal{V})$, it is

tensor-valued
multilinear map

called a *multilinear invariant*. In most cases $k = 0 = l$, and we speak of *scalar-valued invariants*, or simply invariants. An example of a multilinear invariant is the determinant considered as a function of the rows of a matrix.

The following defines an important class of multilinear invariants:

contraction of a tensor

Definition 26.1.9 A **contraction** of a tensor $\mathbf{A} \in \mathcal{T}_s^r(\mathcal{V})$ with respect to a contravariant index at position p and a covariant index at position q is a linear mapping $\mathbf{C}_q^p : \mathcal{T}_s^r(\mathcal{V}) \rightarrow \mathcal{T}_{s-1}^{r-1}(\mathcal{V})$ given *in component form* by

$$[\mathbf{C}_q^p(\mathbf{A})]_{j_1 \dots j_{s-1}}^{i_1 \dots i_{r-1}} = A_{j_1 \dots j_{q-1} k j_{q+1} \dots j_s}^{i_1 \dots i_{p-1} k i_{p+1} \dots i_r} \equiv \sum_k A_{j_1 \dots j_{q-1} k j_{q+1} \dots j_s}^{i_1 \dots i_{p-1} k i_{p+1} \dots i_r}$$

It can be readily shown that contractions are basis-independent. The proof is exactly the same as that for the basis-independence of the trace. In fact, the trace is a special case of a contraction, in which $r = s = 1$.

By applying the contraction mapping repeatedly, we can keep reducing the rank of a tensor. For example,

$$[\mathbf{C}_{q_2}^{p_2} \mathbf{C}_{q_1}^{p_1}(\mathbf{A})]_{j_1 \dots j_{s-2}}^{i_1 \dots i_{r-2}} = A_{j_1 \dots j_{q_1-1} k j_{q_1+1} \dots j_{q_2-1} l j_{q_2+1} \dots j_s}^{i_1 \dots i_{p_1-1} k i_{p_1+1} \dots i_{p_2-1} l i_{p_2+1} \dots i_r}$$

where a sum over repeated indices k and l is understood on the right-hand side. Continuing this process, we get $\mathbf{C}_{q_m}^{p_m} \dots \mathbf{C}_{q_2}^{p_2} \mathbf{C}_{q_1}^{p_1} : \mathcal{T}_s^r(\mathcal{V}) \rightarrow \mathcal{T}_{s-m}^{r-m}(\mathcal{V})$. In particular, if $r = s$, we have $\mathbf{C}_{q_r}^{p_r} \dots \mathbf{C}_{q_2}^{p_2} \mathbf{C}_{q_1}^{p_1} : \mathcal{T}_r^r(\mathcal{V}) \rightarrow \mathbb{R}$. In terms of components, we have

$$\mathbf{C}_r \dots \mathbf{C}_2 \mathbf{C}_1(\mathbf{A}) = A_{i_1 i_2 \dots i_r}^{i_1 i_2 \dots i_r},$$

for $\mathbf{A} \in \mathcal{T}_r^r$. $A_{i_1 i_2 \dots i_r}^{i_1 i_2 \dots i_r}$ are the components of \mathbf{A} in *any* basis. This leads to a pairing of a tensor of type $(r, 0)$ with a tensor of type $(0, r)$. If $\mathbf{A} \in \mathcal{T}_0^r$ and $\mathbf{B} \in \mathcal{T}_r^0$, then $\mathbf{A} \otimes \mathbf{B} \in \mathcal{T}_r^r$, and the pairing $\langle \mathbf{A}, \mathbf{B} \rangle$ can be defined as

$$\langle \mathbf{A}, \mathbf{B} \rangle \equiv \mathbf{C}_r \dots \mathbf{C}_2 \mathbf{C}_1(\mathbf{A} \otimes \mathbf{B}) = A^{i_1 i_2 \dots i_r} B_{i_1 i_2 \dots i_r} \quad (26.8)$$

with Einstein's summation convention in place.

The pairing defined above can also be obtained from evaluation. Let $\{\mathbf{v}_i\}_{i=1}^N$ be a basis of \mathcal{V} and $\{\boldsymbol{\omega}^i\}_{i=1}^N$ its dual basis in \mathcal{V}^* . Then

$$\mathbf{A} = A^{i_1 i_2 \dots i_r} \mathbf{v}_{i_1} \otimes \mathbf{v}_{i_2} \otimes \dots \otimes \mathbf{v}_{i_r}, \quad \mathbf{B} = B_{j_1 j_2 \dots j_r} \boldsymbol{\omega}^{j_1} \otimes \boldsymbol{\omega}^{j_2} \otimes \dots \otimes \boldsymbol{\omega}^{j_r}$$

and

$$\begin{aligned} \mathbf{B}(\mathbf{A}) &= B_{j_1 j_2 \dots j_r} \boldsymbol{\omega}^{j_1} \otimes \boldsymbol{\omega}^{j_2} \otimes \dots \otimes \boldsymbol{\omega}^{j_r} (A^{i_1 i_2 \dots i_r} \mathbf{v}_{i_1}, \mathbf{v}_{i_2}, \dots, \mathbf{v}_{i_r}) \\ &= B_{j_1 j_2 \dots j_r} A^{i_1 i_2 \dots i_r} \boldsymbol{\omega}^{j_1} \otimes \boldsymbol{\omega}^{j_2} \otimes \dots \otimes \boldsymbol{\omega}^{j_r} (\mathbf{v}_{i_1}, \mathbf{v}_{i_2}, \dots, \mathbf{v}_{i_r}) \\ &= B_{j_1 j_2 \dots j_r} A^{i_1 i_2 \dots i_r} \boldsymbol{\omega}^{j_1}(\mathbf{v}_{i_1}) \boldsymbol{\omega}^{j_2}(\mathbf{v}_{i_2}) \dots \boldsymbol{\omega}^{j_r}(\mathbf{v}_{i_r}) \end{aligned}$$

$$= B_{j_1 j_2 \dots j_r} A^{i_1 i_2 \dots i_r} \delta_{i_1}^{j_1} \delta_{i_2}^{j_2} \dots \delta_{i_r}^{j_r} = A^{i_1 i_2 \dots i_r} B_{i_1 i_2 \dots i_r}. \tag{26.9}$$

The linearity inherent in the construction of tensor algebras carries along some of the properties and structures of the underlying vector spaces. One such property is isomorphism. Suppose that $\mathbf{F} : \mathcal{V} \rightarrow \mathcal{U}$ is a vector space isomorphism. Then $\mathbf{F}^* : \mathcal{U}^* \rightarrow \mathcal{V}^*$, the pullback of \mathbf{F} , is also an isomorphism (Proposition 2.5.5). Associated to \mathbf{F} is a linear map—which we denote by the same symbol—from $\mathcal{T}_s^r(\mathcal{V})$ to $\mathcal{T}_s^r(\mathcal{U})$ defined by

$$\underbrace{[\mathbf{F}(\mathbf{T})]}_{\in \mathcal{T}_s^r(\mathcal{U})}(\boldsymbol{\theta}^1, \dots, \boldsymbol{\theta}^r, \mathbf{u}_1, \dots, \mathbf{u}_s) \equiv \mathbf{T}(\mathbf{F}^*\boldsymbol{\theta}^1, \dots, \mathbf{F}^*\boldsymbol{\theta}^r, \mathbf{F}^{-1}\mathbf{u}_1, \dots, \mathbf{F}^{-1}\mathbf{u}_s), \tag{26.10}$$

where $\mathbf{T} \in \mathcal{T}_s^r(\mathcal{V})$, $\boldsymbol{\theta}^i \in \mathcal{U}^*$, and $\mathbf{u}_j \in \mathcal{U}$. The reader may check that this map is an algebra isomorphism (see Definition 3.1.17). We shall use this isomorphism to define derivatives for tensors in Chap. 28.

26.2 Symmetries of Tensors

Many applications demand tensors that have some kind of symmetry property. We have already encountered a symmetric tensor—the metric “tensor” of an inner product: If \mathcal{V} is a vector space and $\mathbf{v}_1, \mathbf{v}_2 \in \mathcal{V}$, then $g(\mathbf{v}_1, \mathbf{v}_2) = g(\mathbf{v}_2, \mathbf{v}_1)$. The following generalizes this property.

Definition 26.2.1 A tensor \mathbf{A} is **symmetric** in the i th and j th variables if its value as a multilinear function is unchanged when these variables are interchanged. Clearly, the two variables must be of the same kind.

symmetric tensor defined

From this definition, it follows that in any basis, the components of a symmetric tensor do not change when the i th and j th indices are interchanged.

Definition 26.2.2 A tensor is **contravariant-symmetric** if it is symmetric in every pair of its contravariant indices and **covariant-symmetric** if it is symmetric in every pair of its covariant indices. A tensor is **symmetric** if it is both contravariant-symmetric and covariant-symmetric.

contravariant-symmetric;
covariant-symmetric;
symmetric

An immediate consequence of this definition is

Theorem 26.2.3 A tensor \mathbf{S} of type $(r, 0)$ is symmetric iff for any permutation π of $1, 2, \dots, r$, and any $\boldsymbol{\tau}^1, \boldsymbol{\tau}^2, \dots, \boldsymbol{\tau}^r$ in \mathcal{V}^* , we have

$$\mathbf{S}(\boldsymbol{\tau}^{\pi(1)}, \boldsymbol{\tau}^{\pi(2)}, \dots, \boldsymbol{\tau}^{\pi(r)}) = \mathbf{S}(\boldsymbol{\tau}^1, \boldsymbol{\tau}^2, \dots, \boldsymbol{\tau}^r)$$

The set $\mathcal{S}^r(\mathcal{V})$ of all symmetric tensors of type $(r, 0)$ forms a subspace of the vector space³ \mathcal{T}_0^r . Similarly, the set of symmetric tensors of type $(0, s)$ forms a subspace \mathcal{S}_s of \mathcal{T}_s^0 . The (independent) components of a symmetric tensor $\mathbf{A} \in \mathcal{S}^r$ are $A_{i_1 i_2 \dots i_r}$, where $i_1 \leq i_2 \leq \dots \leq i_r$; the other components are given by symmetry.

Although a set of symmetric tensors forms a vector space, it does not form an algebra under the usual multiplication of tensors. In fact, even if $\mathbf{A} = A^{ij} \mathbf{e}_i \otimes \mathbf{e}_j$ and $\mathbf{B} = B^{kl} \mathbf{e}_k \otimes \mathbf{e}_l$ are symmetric tensors of type $(2, 0)$, the tensor product $\mathbf{A} \otimes \mathbf{B} = A^{ij} B^{kl} \mathbf{e}_i \otimes \mathbf{e}_j \otimes \mathbf{e}_k \otimes \mathbf{e}_l$ need not be a type $(4, 0)$ symmetric tensor. For instance, $A^{ik} B^{jl}$ may not equal $A^{ij} B^{kl}$. However, we can modify the definition of the tensor product (for symmetric tensors) to give a symmetric product out of symmetric factors.

Definition 26.2.4 A **symmetrizer** is an operator $\mathbb{S} : \mathcal{T}_0^r \rightarrow \mathcal{S}^r$ given by

$$[\mathbb{S}(\mathbf{A})](\boldsymbol{\tau}^1, \dots, \boldsymbol{\tau}^r) = \frac{1}{r!} \sum_{\pi} \mathbf{A}(\boldsymbol{\tau}^{\pi(1)}, \dots, \boldsymbol{\tau}^{\pi(r)}), \quad (26.11)$$

where the sum is taken over the $r!$ permutations of the integers $1, 2, \dots, r$, and $\boldsymbol{\tau}^1, \dots, \boldsymbol{\tau}^r$ are all in \mathcal{V}^* . $\mathbb{S}(\mathbf{A})$ is often denoted by \mathbf{A}_s .

Clearly, \mathbf{A}_s is a symmetric tensor. In fact,

$$\begin{aligned} \mathbf{A}_s(\boldsymbol{\tau}^{\sigma(1)}, \dots, \boldsymbol{\tau}^{\sigma(r)}) &= [\mathbb{S}(\mathbf{A})](\boldsymbol{\tau}^{\sigma(1)}, \dots, \boldsymbol{\tau}^{\sigma(r)}) \\ &= \frac{1}{r!} \sum_{\pi} \mathbf{A}(\boldsymbol{\tau}^{\pi(\sigma(1))}, \dots, \boldsymbol{\tau}^{\pi(\sigma(r))}) \\ &= \frac{1}{r!} \sum_{\pi\sigma} \mathbf{A}(\boldsymbol{\tau}^{\pi\sigma(1)}, \dots, \boldsymbol{\tau}^{\pi\sigma(r)}) \\ &= \mathbf{A}_s(\boldsymbol{\tau}^1, \boldsymbol{\tau}^2, \dots, \boldsymbol{\tau}^r), \end{aligned} \quad (26.12)$$

where we have used the fact that the sum over π is equal to the sum over the product (or composition) $\pi\sigma$, because they both include all permutations. Furthermore, if \mathbf{A} is symmetric, then $\mathbb{S}(\mathbf{A}) = \mathbf{A}$:

$$\begin{aligned} [\mathbb{S}(\mathbf{A})](\boldsymbol{\tau}^1, \dots, \boldsymbol{\tau}^r) &= \frac{1}{r!} \sum_{\pi} \mathbf{A}(\boldsymbol{\tau}^{\pi(1)}, \dots, \boldsymbol{\tau}^{\pi(r)}) = \frac{1}{r!} \sum_{\pi} \mathbf{A}(\boldsymbol{\tau}^1, \dots, \boldsymbol{\tau}^r) \\ &= \frac{1}{r!} \underbrace{\left(\sum_{\pi} 1 \right)}_{=r!} \mathbf{A}(\boldsymbol{\tau}^1, \dots, \boldsymbol{\tau}^r) = \mathbf{A}(\boldsymbol{\tau}^1, \dots, \boldsymbol{\tau}^r). \end{aligned} \quad (26.13)$$

A similar definition gives the symmetrizer $\mathbb{S} : \mathcal{T}_s^0 \rightarrow \mathcal{S}_s$. Instead of $\boldsymbol{\tau}^1, \dots, \boldsymbol{\tau}^r$ in (26.11), we would have $\mathbf{v}_1, \dots, \mathbf{v}_s$.

³When there is no risk of confusion, we shall delete \mathcal{V} from $\mathcal{T}_s^r(\mathcal{V})$, it being understood that all tensors are defined on some given underlying vector space.

Example 26.2.5 For $r = 2$, we have only two permutations, and

$$\mathbf{A}_s(\boldsymbol{\tau}^1, \boldsymbol{\tau}^2) = \frac{1}{2}[\mathbf{A}(\boldsymbol{\tau}^1, \boldsymbol{\tau}^2) + \mathbf{A}(\boldsymbol{\tau}^2, \boldsymbol{\tau}^1)].$$

For $r = 3$, we have six permutations of 1, 2, 3, and (26.11) gives

$$\begin{aligned} \mathbf{A}_s(\boldsymbol{\tau}^1, \boldsymbol{\tau}^2, \boldsymbol{\tau}^3) = \frac{1}{6}[\mathbf{A}(\boldsymbol{\tau}^1, \boldsymbol{\tau}^2, \boldsymbol{\tau}^3) + \mathbf{A}(\boldsymbol{\tau}^2, \boldsymbol{\tau}^1, \boldsymbol{\tau}^3) + \mathbf{A}(\boldsymbol{\tau}^1, \boldsymbol{\tau}^3, \boldsymbol{\tau}^2) \\ + \mathbf{A}(\boldsymbol{\tau}^3, \boldsymbol{\tau}^1, \boldsymbol{\tau}^2) + \mathbf{A}(\boldsymbol{\tau}^3, \boldsymbol{\tau}^2, \boldsymbol{\tau}^1) + \mathbf{A}(\boldsymbol{\tau}^2, \boldsymbol{\tau}^3, \boldsymbol{\tau}^1)]. \end{aligned}$$

It is clear that interchanging any pair of $\boldsymbol{\tau}$'s on the RHS of the above two equations does not change the sum. Thus, \mathbf{A}_s is indeed a symmetric tensor.

It can be shown that

$$\dim \mathcal{S}^r(\mathcal{V}) = \binom{N+r-1}{r} \equiv \frac{(N+r-1)!}{r!(N-1)!}.$$

The proof involves counting the number of different integers i_1, \dots, i_r for which $1 \leq i_m \leq i_{m+1} \leq N$ for each m .

We are now ready to define a product on the collection of symmetric tensors and make it an algebra, called the **symmetric algebra**.

Definition 26.2.6 The **symmetric product** of symmetric tensors $\mathbf{A} \in \mathcal{S}^r(\mathcal{V})$ and $\mathbf{B} \in \mathcal{S}^s(\mathcal{V})$ is denoted by \mathbf{AB} and defined as

$$\begin{aligned} \mathbf{AB}(\boldsymbol{\tau}^1, \dots, \boldsymbol{\tau}^{r+s}) &\equiv \frac{(r+s)!}{r!s!} \mathbb{S}(\mathbf{A} \otimes \mathbf{B})(\boldsymbol{\tau}^1, \dots, \boldsymbol{\tau}^{r+s}) \\ &= \frac{1}{r!s!} \sum_{\pi} \mathbf{A}(\boldsymbol{\tau}^{\pi(1)}, \dots, \boldsymbol{\tau}^{\pi(r)}) \mathbf{B}(\boldsymbol{\tau}^{\pi(r+1)}, \dots, \boldsymbol{\tau}^{\pi(r+s)}), \end{aligned}$$

symmetric tensors form an algebra under this product

where the sum is over all permutations of $1, 2, \dots, r+s$. The symmetric product of $\mathbf{A} \in \mathcal{S}_r(\mathcal{V})$ and $\mathbf{B} \in \mathcal{S}_s(\mathcal{V})$ is defined similarly.

Historical Notes

Leopold Kronecker (1823–1891) was the son of Isidor Kronecker, a businessman, and Johanna Prausnitzer. They were wealthy and provided private tutoring at home for their son until he entered the Liegnitz Gymnasium. At the gymnasium, Kronecker's mathematics teacher was E.E. Kummer, who early recognized the boy's ability and encouraged him to do independent research. He also received Evangelical religious instruction, although he was Jewish; he formally converted to Christianity in the last year of his life.

Kronecker matriculated at the University of Berlin in 1841, where he attended lectures in mathematics given by Dirichlet. Like Gauss and Jacobi, he was interested in classical philology. He also attended Schelling's philosophy lectures; he was later to make a thorough study of the works of Descartes, Spinoza, Leibniz, Kant, and Hegel, as well as those of Schopenhauer, whose ideas he rejected.

Kronecker spent the summer semester of 1843 at the University of Bonn, and the fall semester at Breslau (now Wroclaw, Poland) because Kummer had been appointed professor there. He remained there for two semesters, returning to Berlin in the winter of 1844–1845 to take the doctorate. Kronecker took his oral examination consisting of questions not only in mathematics, but also in Greek history of legal philosophy. He was awarded the doctorate on 10 September 1845.



Leopold Kronecker
1823–1891

Dirichlet, his professor and examiner, was to remain one of Kronecker's closest friends, as was Kummer, his first mathematics teacher. In the meantime, in Berlin, Kronecker was also becoming better acquainted with Eisenstein and with Jacobi. During the same period Dirichlet introduced him to Alexander von Humboldt and to the composer Felix Mendelssohn, who was both Dirichlet's brother-in-law and the cousin of Kummer's wife. Family business then called Kronecker from Berlin. In its interest he was required to spend a few years managing an estate near Liegnitz, as well as to dissolve the banking business of an uncle. In 1848 he married the latter's daughter, his cousin Fanny Prausnitzner; they had six children. Having temporarily renounced an academic career, Kronecker continued to do mathematics as a recreation. He both carried on independent research and engaged in a lively mathematical correspondence with Kummer; he was not ambitious for fame, and was able to enjoy mathematics as a true amateur. By 1855, however, Kronecker's circumstances had changed enough to allow him to return to the academic life in Berlin as a financially independent private scholar.

In 1860 Kummer, seconded by Borchardt and Weierstrass, nominated Kronecker to the Berlin Academy, of which he became full member on 23 January 1861. Kronecker was increasingly active and influential in the affairs of the Academy, particularly in recruiting the most important German and foreign mathematicians for it. His influence outside Germany also increased. He was a member of many learned societies, among them the Paris Academy and the Royal Society of London. He established other contacts with foreign scientists in his numerous travels abroad and in extending to them the hospitality of his Berlin home. For this reason his advice was often solicited in regard to filling mathematical professorships both in Germany and elsewhere; his recommendations were probably as significant as those of his erstwhile friend Weierstrass.

The cause of the growing estrangement between Kronecker and Weierstrass was partly due to the very different temperaments of the two, and their professional and scientific differences. Since they had long maintained the same circle of friends, their friends, too, became involved on both levels. A characteristic incident occurred at the new year of 1884–1885, when H. A. Schwarz, who was both Weierstrass's student and Kummer's son-in-law, sent Kronecker a greeting that included the phrase: "He who does not honor the Smaller [Kronecker], is not worthy of the Greater [Weierstrass]." Kronecker read this allusion to physical size—he was a small man, and increasingly self-conscious with age—as a slur on his intellectual powers and broke with Schwarz completely.

Kronecker's mathematics lacked a systematic theoretical basis. Nevertheless, he was pre-eminent in uniting the separate mathematical disciplines. Moreover, in certain ways—his refusal to recognize an actual infinity, his insistence that a mathematical concept must be defined in a finite number of steps, and his opposition to the work of Cantor and Dedekind—his approach may be compared to that of intuitionists in the twentieth century. Kronecker's mathematics thus remains influential.

Example 26.2.7 Let us construct the symmetric tensor products of vectors. First we find the symmetric product of \mathbf{v}_1 and \mathbf{v}_2 both belonging to $\mathcal{V} = \mathcal{T}_0^1(\mathcal{V})$:

$$\begin{aligned} (\mathbf{v}_1 \mathbf{v}_2)(\boldsymbol{\tau}^1, \boldsymbol{\tau}^2) &\equiv \mathbf{v}_1(\boldsymbol{\tau}^1) \mathbf{v}_2(\boldsymbol{\tau}^2) + \mathbf{v}_1(\boldsymbol{\tau}^2) \mathbf{v}_2(\boldsymbol{\tau}^1) \\ &= \mathbf{v}_1(\boldsymbol{\tau}^1) \mathbf{v}_2(\boldsymbol{\tau}^2) + \mathbf{v}_2(\boldsymbol{\tau}^1) \mathbf{v}_1(\boldsymbol{\tau}^2) \\ &= (\mathbf{v}_1 \otimes \mathbf{v}_2 + \mathbf{v}_2 \otimes \mathbf{v}_1)(\boldsymbol{\tau}^1, \boldsymbol{\tau}^2). \end{aligned}$$

Since this is true for any pair $\boldsymbol{\tau}^1$ and $\boldsymbol{\tau}^2$, we have

$$\mathbf{v}_1 \mathbf{v}_2 = \mathbf{v}_1 \otimes \mathbf{v}_2 + \mathbf{v}_2 \otimes \mathbf{v}_1.$$

In general, $\mathbf{v}_1 \mathbf{v}_2 \cdots \mathbf{v}_r = \sum_{\pi} \mathbf{v}_{\pi(1)} \otimes \mathbf{v}_{\pi(2)} \otimes \cdots \otimes \mathbf{v}_{\pi(r)}$.

It is clear from the definition that symmetric multiplication is commutative, associative, and distributive. If we choose a basis $\{\mathbf{e}_i\}_{i=1}^N$ for \mathcal{V} and

express all symmetric tensors in terms of symmetric products of \mathbf{e}_i using the above properties, then any symmetric tensor can be expressed as a linear combination of terms of the form $(\mathbf{e}_1)^{n_1} \cdots (\mathbf{e}_N)^{n_N}$.

Skew-symmetry or **antisymmetry** is the same as symmetry except that in the interchange of variables the tensor changes sign.

Definition 26.2.8 A **covariant (contravariant) skew-symmetric** (or anti-symmetric) tensor is one that is skew-symmetric in all pairs of covariant (contravariant) variables. A tensor is skew-symmetric if it is both covariant and contravariant skew-symmetric.

covariant and
contravariant
skew-symmetric tensors

The analogue of Theorem 26.2.3 is

Theorem 26.2.9 A tensor \mathbf{A} of type $(r, 0)$ is skew iff for any permutation π of $1, 2, \dots, r$, and any $\boldsymbol{\tau}^1, \boldsymbol{\tau}^2, \dots, \boldsymbol{\tau}^r$ in \mathcal{V}^* , we have

$$\mathbf{A}(\boldsymbol{\tau}^{\pi(1)}, \boldsymbol{\tau}^{\pi(2)}, \dots, \boldsymbol{\tau}^{\pi(r)}) = \epsilon_\pi \mathbf{A}(\boldsymbol{\tau}^1, \boldsymbol{\tau}^2, \dots, \boldsymbol{\tau}^r).$$

Definition 26.2.10 An **antisymmetrizer** is a linear operator \mathbb{A} on \mathcal{T}_0^r , given by

antisymmetrizer

$$[\mathbb{A}(\mathbf{T})](\boldsymbol{\tau}^1, \dots, \boldsymbol{\tau}^r) = \frac{1}{r!} \sum_{\pi} \epsilon_\pi \mathbf{T}(\boldsymbol{\tau}^{\pi(1)}, \dots, \boldsymbol{\tau}^{\pi(r)}). \quad (26.14)$$

$\mathbb{A}(\mathbf{T})$ is often denoted by \mathbf{T}_a .

Clearly, \mathbf{T}_a is an antisymmetric tensor. In fact, using $(\epsilon_\sigma)^2 = 1$, which holds for any permutation, we have

$$\begin{aligned} \mathbf{T}_a(\boldsymbol{\tau}^{\sigma(1)}, \dots, \boldsymbol{\tau}^{\sigma(r)}) &= [\mathbb{A}(\mathbf{T})](\boldsymbol{\tau}^{\sigma(1)}, \dots, \boldsymbol{\tau}^{\sigma(r)}) \\ &= (\epsilon_\sigma)^2 \frac{1}{r!} \sum_{\pi} \epsilon_\pi \mathbf{A}(\boldsymbol{\tau}^{\pi\sigma(1)}, \dots, \boldsymbol{\tau}^{\pi\sigma(r)}) \\ &= \epsilon_\sigma \frac{1}{r!} \sum_{\pi\sigma} \epsilon_\pi \epsilon_\sigma \mathbf{T}(\boldsymbol{\tau}^{\pi\sigma(1)}, \dots, \boldsymbol{\tau}^{\pi\sigma(r)}) \\ &= \epsilon_\sigma \mathbf{T}_a(\boldsymbol{\tau}^1, \boldsymbol{\tau}^2, \dots, \boldsymbol{\tau}^r), \end{aligned} \quad (26.15)$$

where we have used the fact that $\epsilon_\pi \epsilon_\sigma = \epsilon_{\pi\sigma}$ as can be easily verified. If \mathbf{T} is antisymmetric, then $\mathbb{A}(\mathbf{T}) = \mathbf{T}$:

$$\begin{aligned} [\mathbb{A}(\mathbf{T})](\boldsymbol{\tau}^1, \dots, \boldsymbol{\tau}^r) &= \frac{1}{r!} \sum_{\pi} \epsilon_\pi \mathbf{T}(\boldsymbol{\tau}^{\pi(1)}, \dots, \boldsymbol{\tau}^{\pi(r)}) \\ &= \frac{1}{r!} \sum_{\pi} \overbrace{(\epsilon_\pi)^2}^{=1} \mathbf{T}(\boldsymbol{\tau}^1, \dots, \boldsymbol{\tau}^r) \\ &= \frac{1}{r!} \underbrace{\left(\sum_{\pi} 1 \right)}_{=r!} \mathbf{T}(\boldsymbol{\tau}^1, \dots, \boldsymbol{\tau}^r) = \mathbf{T}(\boldsymbol{\tau}^1, \dots, \boldsymbol{\tau}^r). \end{aligned} \quad (26.16)$$

A similar definition gives the antisymmetrizer \mathbb{A} on \mathcal{T}_s^0 . Instead of $\boldsymbol{\tau}^1, \dots, \boldsymbol{\tau}^r$ in (26.14), we would have $\mathbf{v}_1, \dots, \mathbf{v}_s$.

Example 26.2.11 Let us write out Eq. (26.14) for $r = 3$. The procedure is entirely analogous to Example 26.2.5:

$$\begin{aligned} \mathbf{T}_a(\boldsymbol{\tau}^1, \boldsymbol{\tau}^2, \boldsymbol{\tau}^3) &= \frac{1}{6} [\epsilon_{123} \mathbf{A}(\boldsymbol{\tau}^1, \boldsymbol{\tau}^2, \boldsymbol{\tau}^3) + \epsilon_{213} \mathbf{A}(\boldsymbol{\tau}^2, \boldsymbol{\tau}^1, \boldsymbol{\tau}^3) \\ &\quad + \epsilon_{132} \mathbf{A}(\boldsymbol{\tau}^1, \boldsymbol{\tau}^3, \boldsymbol{\tau}^2) + \epsilon_{312} \mathbf{A}(\boldsymbol{\tau}^3, \boldsymbol{\tau}^1, \boldsymbol{\tau}^2) \\ &\quad + \epsilon_{321} \mathbf{A}(\boldsymbol{\tau}^3, \boldsymbol{\tau}^2, \boldsymbol{\tau}^1) + \epsilon_{231} \mathbf{A}(\boldsymbol{\tau}^2, \boldsymbol{\tau}^3, \boldsymbol{\tau}^1)] \\ &= \frac{1}{6} [\mathbf{A}(\boldsymbol{\tau}^1, \boldsymbol{\tau}^2, \boldsymbol{\tau}^3) - \mathbf{A}(\boldsymbol{\tau}^2, \boldsymbol{\tau}^1, \boldsymbol{\tau}^3) - \mathbf{A}(\boldsymbol{\tau}^1, \boldsymbol{\tau}^3, \boldsymbol{\tau}^2) \\ &\quad + \mathbf{A}(\boldsymbol{\tau}^3, \boldsymbol{\tau}^1, \boldsymbol{\tau}^2) - \mathbf{A}(\boldsymbol{\tau}^3, \boldsymbol{\tau}^2, \boldsymbol{\tau}^1) + \mathbf{A}(\boldsymbol{\tau}^2, \boldsymbol{\tau}^3, \boldsymbol{\tau}^1)]. \end{aligned}$$

The reader may easily verify that all terms with a plus sign are obtained from (123) by an even number of interchanges of symbols, and those with a minus sign by an odd number.

26.3 Exterior Algebra

The following discussion will concentrate on tensors of type $(r, 0)$. However, interchanging the roles of \mathcal{V} and \mathcal{V}^* makes all definitions, theorems, propositions, and conclusions valid for tensors of type $(0, s)$ as well.

The set of all skew-symmetric tensors of type $(p, 0)$ forms a subspace of $\mathcal{T}_0^p(\mathcal{V})$. This subspace is denoted by $\Lambda^p(\mathcal{V}^*)$ and its members are called **p -vectors**.⁴ It is not, however, an algebra unless we define a skew-symmetric product analogous to that for the symmetric case. This is done in the following definition:

Definition 26.3.1 The **exterior product** (also called the **wedge**, *Grassmann*, *alternating*, or *veck* product) of two skew-symmetric tensors $\mathbf{A} \in \Lambda^p(\mathcal{V}^*)$ and $\mathbf{B} \in \Lambda^q(\mathcal{V}^*)$ is a skew-symmetric tensor belonging to $\Lambda^{p+q}(\mathcal{V}^*)$ and given by⁵

$$\mathbf{A} \wedge \mathbf{B} \equiv \frac{(r+s)!}{r!s!} \mathbb{A}(\mathbf{A} \otimes \mathbf{B}) = \frac{(r+s)!}{r!s!} (\mathbf{A} \otimes \mathbf{B})_a.$$

⁴The use of \mathcal{V}^* in $\Lambda^p(\mathcal{V}^*)$ is by convention. Since a member of $\Lambda^p(\mathcal{V}^*)$ acts on p dual vectors, it is more natural to use \mathcal{V}^* .

⁵The reader should be warned that different authors may use different numerical coefficients in the definition of the exterior product.

More explicitly,

$$\begin{aligned} \mathbf{A} \wedge \mathbf{B}(\boldsymbol{\tau}^1, \dots, \boldsymbol{\tau}^{r+s}) \\ = \frac{1}{r!s!} \sum_{\pi} \epsilon_{\pi} \mathbf{A}(\boldsymbol{\tau}^{\pi(1)}, \dots, \boldsymbol{\tau}^{\pi(r)}) \mathbf{B}(\boldsymbol{\tau}^{\pi(r+1)}, \dots, \boldsymbol{\tau}^{\pi(r+s)}). \end{aligned}$$

Example 26.3.2 Let us find the exterior product of \mathbf{v}_1 and \mathbf{v}_2 both belonging to $\mathcal{V} = \mathcal{J}_0^1(\mathcal{V})$, so that $r = s = 1$:

$$\begin{aligned} \mathbf{v}_1 \wedge \mathbf{v}_2(\boldsymbol{\tau}^1, \boldsymbol{\tau}^2) &= \sum_{\pi} \epsilon_{\pi} \mathbf{v}_1(\boldsymbol{\tau}^{\pi(1)}) \mathbf{v}_2(\boldsymbol{\tau}^{\pi(2)}) \\ &= \mathbf{v}_1(\boldsymbol{\tau}^1) \mathbf{v}_2(\boldsymbol{\tau}^2) - \mathbf{v}_1(\boldsymbol{\tau}^2) \mathbf{v}_2(\boldsymbol{\tau}^1) \\ &= (\mathbf{v}_1 \otimes \mathbf{v}_2 - \mathbf{v}_2 \otimes \mathbf{v}_1)(\boldsymbol{\tau}^1, \boldsymbol{\tau}^2). \end{aligned}$$

Since this is true for arbitrary $\boldsymbol{\tau}^1$ and $\boldsymbol{\tau}^2$, we have

$$\mathbf{v}_1 \wedge \mathbf{v}_2 = \mathbf{v}_1 \otimes \mathbf{v}_2 - \mathbf{v}_2 \otimes \mathbf{v}_1 = 2! \mathbb{A}(\mathbf{v}_1 \otimes \mathbf{v}_2).$$

The result of the example above can be generalized to

$$\mathbf{v}_1 \wedge \dots \wedge \mathbf{v}_r = r! \mathbb{A}(\mathbf{v}_1 \otimes \dots \otimes \mathbf{v}_r) = \sum_{\pi} \epsilon_{\pi} \mathbf{v}_{\pi(1)} \otimes \dots \otimes \mathbf{v}_{\pi(r)}. \quad (26.17)$$

In particular, this shows that the exterior product (of vectors) is associative. If $\{\mathbf{e}_j\}_{j=1}^N$ is a basis with dual $\{\boldsymbol{\epsilon}^i\}_{i=1}^N$, then Eq. (26.17) gives

$$\mathbf{e}_1 \wedge \dots \wedge \mathbf{e}_N(\boldsymbol{\epsilon}^{i_1}, \dots, \boldsymbol{\epsilon}^{i_N}) = \sum_{\pi} \epsilon_{\pi} \delta_{\pi(1)}^{i_1} \dots \delta_{\pi(N)}^{i_N} = \epsilon_{i_1, \dots, i_N}. \quad (26.18)$$

The last equality follows from the fact that the sum is zero unless i_1, \dots, i_N is a permutation of $1, \dots, N$ and it is 1 if the permutation is even and -1 if it is odd. We obtain the same result if we switch the \mathbf{e} 's and the $\boldsymbol{\epsilon}$'s:

$$\boldsymbol{\epsilon}^1 \wedge \dots \wedge \boldsymbol{\epsilon}^N(\mathbf{e}_{i_1}, \dots, \mathbf{e}_{i_N}) = \sum_{\pi} \epsilon_{\pi} \delta_{i_1}^{\pi(1)} \dots \delta_{i_N}^{\pi(N)} = \epsilon_{i_1, \dots, i_N}. \quad (26.19)$$

Another useful result is obtained when the indices of the last equation are switched:

$$\boldsymbol{\epsilon}^{i_1} \wedge \dots \wedge \boldsymbol{\epsilon}^{i_N}(\mathbf{e}_1, \dots, \mathbf{e}_N) = \sum_{\pi} \epsilon_{\pi} \delta_1^{\pi(i_1)} \dots \delta_N^{\pi(i_N)}.$$

Now note that

$$\delta_k^{\pi(i_k)} \iff \pi(i_k) = k \iff i_k = \pi^{-1}(k) \iff \delta_k^{\pi(i_k)} = \delta_{\pi^{-1}(k)}^{i_k}.$$

Furthermore, $\sum_{\pi} = \sum_{\pi^{-1}}$ and $\epsilon_{\pi} = \epsilon_{\pi^{-1}}$. Denoting π^{-1} by σ , the equation above gives

$$\boldsymbol{\epsilon}^{i_1} \wedge \dots \wedge \boldsymbol{\epsilon}^{i_N}(\mathbf{e}_1, \dots, \mathbf{e}_N) = \sum_{\sigma} \epsilon_{\sigma} \delta_{\sigma(1)}^{i_1} \dots \delta_{\sigma(N)}^{i_N} = \epsilon_{i_1, \dots, i_N}. \quad (26.20)$$

The following theorem contains the properties of the exterior product (for a proof, see [Abra 88, p. 394]):

Theorem 26.3.3 *The exterior product is associative and distributive with respect to the addition of tensors. Furthermore, it satisfies the following **anticommutativity** property:*

$$\mathbf{A} \wedge \mathbf{B} = (-1)^{pq} \mathbf{B} \wedge \mathbf{A}$$

whenever $\mathbf{A} \in \Lambda^p(\mathcal{V}^*)$ and $\mathbf{B} \in \Lambda^q(\mathcal{V}^*)$. In particular, $\mathbf{v}_1 \wedge \mathbf{v}_2 = -\mathbf{v}_2 \wedge \mathbf{v}_1$ for $\mathbf{v}_1, \mathbf{v}_2 \in \mathcal{V}$.

The wedge product of linear functionals of a vector space is particularly important in the analysis of tensors, as we shall see in the next chapter.

p -forms defined **Definition 26.3.4** The elements of $\Lambda^p(\mathcal{V})$ are called **p-forms**.

pull-back of p -forms by linear transformations A linear transformation $\mathbf{T} : \mathcal{V} \rightarrow \mathcal{W}$ induces a transformation⁶ $\mathbf{T}^* : \Lambda^p(\mathcal{W}) \rightarrow \Lambda^p(\mathcal{V})$ defined by

$$(\mathbf{T}^*\boldsymbol{\rho})(\mathbf{v}_1, \dots, \mathbf{v}_p) \equiv \boldsymbol{\rho}(\mathbf{T}\mathbf{v}_1, \dots, \mathbf{T}\mathbf{v}_p), \quad \boldsymbol{\rho} \in \Lambda^p(\mathcal{W}), \quad \mathbf{v}_i \in \mathcal{V}. \quad (26.21)$$

$\mathbf{T}^*\boldsymbol{\rho}$ is called the **pullback** of $\boldsymbol{\rho}$ by \mathbf{T} . The most important properties of pullback maps are given in the following:

Proposition 26.3.5 *Let $\mathbf{T} : \mathcal{V} \rightarrow \mathcal{W}$ and $\mathbf{S} : \mathcal{W} \rightarrow \mathcal{U}$. Then*

1. $\mathbf{T}^* : \Lambda^p(\mathcal{W}) \rightarrow \Lambda^p(\mathcal{V})$ is linear.
2. $(\mathbf{S} \circ \mathbf{T})^* = \mathbf{T}^* \circ \mathbf{S}^*$.
3. If \mathbf{T} is the identity map, so is \mathbf{T}^* .
4. If \mathbf{T} is an isomorphism, so is \mathbf{T}^* and $(\mathbf{T}^*)^{-1} = (\mathbf{T}^{-1})^*$.
5. If $\boldsymbol{\rho} \in \Lambda^p(\mathcal{W})$ and $\boldsymbol{\sigma} \in \Lambda^q(\mathcal{W})$, then $\mathbf{T}^*(\boldsymbol{\rho} \wedge \boldsymbol{\sigma}) = \mathbf{T}^*\boldsymbol{\rho} \wedge \mathbf{T}^*\boldsymbol{\sigma}$.

Proof The proof follows directly from definitions and is left as an exercise for the reader. \square

If $\{\mathbf{e}_i\}_{i=1}^N$ is a basis of \mathcal{V} , we can form a basis for $\Lambda^p(\mathcal{V}^*)$ by constructing all products of the form $\mathbf{e}_{i_1} \wedge \mathbf{e}_{i_2} \wedge \dots \wedge \mathbf{e}_{i_p}$. The number of linearly independent such vectors, which is the dimension of $\Lambda^p(\mathcal{V}^*)$, is equal to the number of ways p numbers can be chosen from among N distinct numbers in such a way that no two of them are equal. This is simply the combination of N objects taken p at a time. Thus, we have

$$\dim \Lambda^p(\mathcal{V}^*) = \binom{N}{p} = \frac{N!}{p!(N-p)!}. \quad (26.22)$$

⁶Note that \mathbf{T}^* is the extension of the pullback operator introduced at the end of Chap. 2.

In particular, $\dim \Lambda^N(\mathcal{V}^*) = 1$.

Any $\mathbf{A} \in \Lambda^p(\mathcal{V}^*)$ can be written as

$$\begin{aligned} \mathbf{A} &= \sum_{i_1 < i_2 < \dots < i_p}^N A^{i_1 \dots i_p} \mathbf{e}_{i_1} \wedge \mathbf{e}_{i_2} \wedge \dots \wedge \mathbf{e}_{i_p} \\ &= \frac{1}{p!} \sum_{i_1, i_2, \dots, i_p}^N A^{i_1 \dots i_p} \mathbf{e}_{i_1} \wedge \mathbf{e}_{i_2} \wedge \dots \wedge \mathbf{e}_{i_p} \end{aligned} \quad (26.23)$$

where $A^{i_1 \dots i_p}$ are the components of \mathbf{A} , which are assumed completely anti-symmetric in all i_1, i_2, \dots, i_p . In the second sum, all i 's run from 1 to N .

Exterior algebra defined.

Theorem 26.3.6 Set $\Lambda^0(\mathcal{V}^*) = \mathbb{R}$ and let $\Lambda(\mathcal{V}^*)$ denote the direct sum of all $\Lambda^p(\mathcal{V}^*)$:

$$\Lambda(\mathcal{V}^*) = \bigoplus_{p=0}^N \Lambda^p(\mathcal{V}^*) \equiv \mathbb{R} \oplus \mathcal{V} \oplus \Lambda^2(\mathcal{V}^*) \oplus \dots \oplus \Lambda^N(\mathcal{V}^*).$$

Then $\Lambda(\mathcal{V}^*)$ is a 2^N -dimensional algebra with exterior product defining its multiplication rule.

Proof The only thing to prove is the dimensionality of the algebra, which is an easy consequence of Eq. (26.22) and the binomial expansion of $(1+1)^N$:

$$2^N = (1+1)^N = \sum_{p=0}^N \binom{N}{p} 1^p 1^{N-p} = \sum_{p=0}^N \binom{N}{p}. \quad \square$$

Given two vector spaces \mathcal{V} and \mathcal{U} , one can construct a tensor product of $\Lambda(\mathcal{V}^*)$ and $\Lambda(\mathcal{U}^*)$ and define a product \odot on it as follows. Let $\mathbf{A}_i \in \Lambda^{p_i}(\mathcal{V}^*)$, $i = 1, 2$ and $\mathbf{B}_j \in \Lambda^{q_j}(\mathcal{U}^*)$, $j = 1, 2$. Then

$$(\mathbf{A}_1 \otimes \mathbf{B}_1) \odot (\mathbf{A}_2 \otimes \mathbf{B}_2) \equiv (-1)^{p_2 q_1} (\mathbf{A}_1 \wedge \mathbf{A}_2) \otimes (\mathbf{B}_1 \wedge \mathbf{B}_2). \quad (26.24)$$

Definition 26.3.7 The tensor product of the two vector spaces $\Lambda(\mathcal{V}^*)$ and $\Lambda(\mathcal{U}^*)$ together with the product given in Eq. (26.24) is called **skew tensor product** of $\Lambda(\mathcal{V}^*)$ and $\Lambda(\mathcal{U}^*)$ and denoted by $\Lambda(\mathcal{V}^*) \hat{\otimes} \Lambda(\mathcal{U}^*)$.

An elegant way of determining the linear independence of vectors using the formalism developed so far is given in the following proposition.

Proposition 26.3.8 A set of vectors, $\mathbf{v}_1, \dots, \mathbf{v}_p$, is linearly independent if and only if $\mathbf{v}_1 \wedge \dots \wedge \mathbf{v}_p \neq 0$.

Proof If $\{\mathbf{v}_i\}_{i=1}^p$ are independent, then they span a p -dimensional subspace \mathcal{M} of \mathcal{V} . Considering \mathcal{M} as a vector space in its own right, we have $\dim \Lambda^p(\mathcal{M}^*) = 1$. A basis for $\Lambda^p(\mathcal{M}^*)$ is simply $\mathbf{v}_1 \wedge \cdots \wedge \mathbf{v}_p$, which cannot be zero.

Conversely, suppose that $\alpha_1 \mathbf{v}_1 + \cdots + \alpha_p \mathbf{v}_p = 0$. Then taking the exterior product of the LHS with $\mathbf{v}_2 \wedge \mathbf{v}_3 \wedge \cdots \wedge \mathbf{v}_p$ makes all terms vanish (because each will have two factors of a vector in the wedge product) except the first one. Thus, we have $\alpha_1 \mathbf{v}_1 \wedge \cdots \wedge \mathbf{v}_p = 0$. The fact that the wedge product is not zero forces α_1 to be zero. Similarly, multiplying by $\mathbf{v}_1 \wedge \mathbf{v}_3 \wedge \cdots \wedge \mathbf{v}_p$ shows that $\alpha_2 = 0$, and so on. \square

Example 26.3.9 Let $\{\mathbf{e}_i\}_{i=1}^3$ be a basis for \mathcal{V} . Let $\mathbf{v}_1 = \mathbf{e}_1 + 2\mathbf{e}_2 - \mathbf{e}_3$, $\mathbf{v}_2 = 3\mathbf{e}_1 + \mathbf{e}_2 + 2\mathbf{e}_3$, $\mathbf{v}_3 = -\mathbf{e}_1 - 3\mathbf{e}_2 + 2\mathbf{e}_3$.

Take the wedge product of the first two \mathbf{v} 's:

$$\begin{aligned}\mathbf{v}_1 \wedge \mathbf{v}_2 &= (\mathbf{e}_1 + 2\mathbf{e}_2 - \mathbf{e}_3) \wedge (3\mathbf{e}_1 + \mathbf{e}_2 + 2\mathbf{e}_3) \\ &= -5\mathbf{e}_1 \wedge \mathbf{e}_2 + 5\mathbf{e}_1 \wedge \mathbf{e}_3 + 5\mathbf{e}_2 \wedge \mathbf{e}_3.\end{aligned}$$

All the wedge products that have repeated factors vanish. Now we multiply by \mathbf{v}_3 :

$$\begin{aligned}\mathbf{v}_1 \wedge \mathbf{v}_2 \wedge \mathbf{v}_3 &= -5\mathbf{e}_1 \wedge \mathbf{e}_2 \wedge (-\mathbf{e}_1 - 3\mathbf{e}_2 + 2\mathbf{e}_3) \\ &\quad + 5\mathbf{e}_1 \wedge \mathbf{e}_3 \wedge (-\mathbf{e}_1 - 3\mathbf{e}_2 + 2\mathbf{e}_3) \\ &\quad + 5\mathbf{e}_2 \wedge \mathbf{e}_3 \wedge (-\mathbf{e}_1 - 3\mathbf{e}_2 + 2\mathbf{e}_3) \\ &= -10\mathbf{e}_1 \wedge \mathbf{e}_2 \wedge \mathbf{e}_3 - 15\mathbf{e}_1 \wedge \mathbf{e}_3 \wedge \mathbf{e}_2 - 5\mathbf{e}_2 \wedge \mathbf{e}_3 \wedge \mathbf{e}_1 = 0.\end{aligned}$$

We conclude that the three vectors are linearly dependent.

As an application of Proposition 26.3.8, let us prove the following.

Cartan's lemma **Theorem 26.3.10** (Cartan's lemma) *Suppose that $\{\mathbf{e}_i\}_{i=1}^p$, $p \leq \dim \mathcal{V}$, form a linearly independent set of vectors in \mathcal{V} and that $\{\mathbf{v}_i\}_{i=1}^p$ are also vectors in \mathcal{V} such that $\sum_{i=1}^p \mathbf{e}_i \wedge \mathbf{v}_i = 0$. Then all \mathbf{v}_i are linear combinations of only the set $\{\mathbf{e}_i\}_{i=1}^p$. Furthermore, if $\mathbf{v}_i = \sum_{j=1}^p A_{ij} \mathbf{e}_j$, then $A_{ij} = A_{ji}$.*

Proof Multiplying both sides of $\sum_{i=1}^p \mathbf{e}_i \wedge \mathbf{v}_i = 0$ by $\mathbf{e}_2 \wedge \cdots \wedge \mathbf{e}_p$ gives

$$-\mathbf{v}_1 \wedge \mathbf{e}_1 \wedge \mathbf{e}_2 \wedge \cdots \wedge \mathbf{e}_p = 0.$$

By Proposition 26.3.8, \mathbf{v}_1 and the \mathbf{e}_i are linearly dependent. Similarly, by multiplying $\sum_{i=1}^p \mathbf{e}_i \wedge \mathbf{v}_i = 0$ by the wedge product with \mathbf{e}_k missing, we show that \mathbf{v}_k and the \mathbf{e}_i are linearly dependent. Thus, $\mathbf{v}_k = \sum_{i=1}^p A_{ki} \mathbf{e}_i$, for all k . Furthermore, we have

$$0 = \sum_{k=1}^p \mathbf{e}_k \wedge \mathbf{v}_k = \sum_{k=1}^p \sum_{i=1}^p \mathbf{e}_k \wedge (A_{ki} \mathbf{e}_i) = \sum_{k < i} (A_{ki} - A_{ik}) \mathbf{e}_k \wedge \mathbf{e}_i,$$

where the last sum is over both k and i with $k < i$. Clearly, $\{\mathbf{e}_k \wedge \mathbf{e}_i\}$ with $k < i$ are linearly independent (show this!). Therefore, their coefficients must vanish. \square

Historical Notes

Elie Joseph Cartan (1869–1951), born in Dolomieu (near Chambéry), Savoie, Rhône-Alpes, France, became a student at the Ecole Normale in 1888 and obtained his doctorate in 1894. He lectured at Montpellier (1894–1896), Lyon (1896–1903), Nancy (1903–1909), and Paris (1909–1940). He had four children, one of whom, Henri Cartan, was to produce brilliant work in mathematics. Two others died tragically. Jean, a composer, died at the age of 25, while Louis, a physicist, was arrested by the Germans in 1942 and executed after 15 months in captivity.



Elie Joseph Cartan
1869–1951

Cartan added greatly to the theory of continuous groups, which had been initiated by Lie. His thesis (1894) contains a major contribution to Lie algebras wherein he completed the classification of the semi-simple algebras that Killing had essentially found. He then turned to the theory of associative algebras and investigated the structure for these algebras over the real and complex fields. Wedderburn would complete Cartan’s work in this area.

He then turned to representations of semisimple Lie groups. His work is a striking synthesis of Lie theory, classical geometry, differential geometry, and topology, which was to be found in all Cartan’s work. He also applied Grassmann algebra to the theory of exterior differential forms.

By 1904 Cartan was turning to papers on differential equations, and from 1916 on he published mainly on differential geometry. Klein’s *Erlanger Program* was seen to be inadequate as a general description of geometry by Weyl and Veblen, and Cartan was to play a major role. He examined a space acted on by an arbitrary Lie group of transformations, developing a theory of moving frames that generalizes the kinematical theory of Darboux.

Cartan further contributed to geometry with his theory of symmetric spaces, which have their origins in papers he wrote in 1926. It develops ideas first studied by Clifford and Cayley and used topological methods developed by Weyl in 1925. This work was completed by 1932.

Cartan then went on to examine problems on a topic first studied by Poincaré. By this stage his son, Henri Cartan, was making major contributions to mathematics, and Elie Cartan was able to build on theorems proved by his son.

Cartan also published work on relativity and the theory of spinors. He is certainly one of the most important mathematicians of the first half of the twentieth century.

Example 26.3.11 The symbol $\epsilon_{i_1 i_2 \dots i_N}$, called the **Levi-Civita tensor**, can be *defined* by

Levi-Civita tensor and determinants

$$\epsilon^{i_1} \wedge \dots \wedge \epsilon^{i_N} = \epsilon_{i_1 \dots i_N} \epsilon^1 \wedge \dots \wedge \epsilon^N. \tag{26.25}$$

In fact, substituting $(\mathbf{e}_1, \dots, \mathbf{e}_1)$ on both sides and using Eq. (26.20), the uniqueness theorem 2.6.4 proves the equality in (26.25).

Now consider the linear operator \mathbf{E} whose action on a basis $\{\mathbf{e}_i\}_{i=1}^N$ is to permute the vectors so that $\mathbf{E}\mathbf{e}_k = \mathbf{e}_{i_k}$. Denote the left-hand side of (26.25) by Δ' (a determinant function as defined in Chap. 2) and the N -form on the right-hand side by Δ . Now note that

$$\Delta'_E = \det \mathbf{E} \cdot \Delta' = \det \mathbf{E} \cdot \epsilon_{i_1 \dots i_N} \Delta.$$

Evaluate both sides on $(\mathbf{e}_1, \dots, \mathbf{e}_N)$ and convince yourself that both determinant functions give 1. This yields $1 = \det \mathbf{E} \cdot \epsilon_{i_1 \dots i_N}$. Since $(\epsilon_{i_1 \dots i_N})^2 = 1$, multiplying both sides by the Levi-Civita tensor, we get $\det \mathbf{E} = \epsilon_{i_1 i_2 \dots i_N}$.

Since the determinant is basis-independent, the result of the previous example can be summarized as follows:

Box 26.3.12 *The Levi-Civita tensor $\epsilon_{i_1 i_2 \dots i_N}$ takes the same value in all coordinate systems.*

There is a generalization of $\Lambda^p(\mathcal{V})$ that is useful when we discuss Clifford algebras in Chap. 27:

Definition 26.3.13 A \mathcal{U} -valued p -form, is a linear machine that takes p vectors from \mathcal{V} and produces a vector in \mathcal{U} . The space of \mathcal{U} -valued p -forms is denoted by $\Lambda^p(\mathcal{V}, \mathcal{U})$. In this new context, $\Lambda^p(\mathcal{V}) = \Lambda^p(\mathcal{V}, \mathbb{R})$.

26.3.1 Orientation

The reader is no doubt familiar with the right-handed and left-handed coordinate systems in \mathbb{R}^3 . In this section, we generalize the idea to arbitrary vector spaces.

oriented basis defined **Definition 26.3.14** An **oriented basis** of an N -dimensional vector space is an ordered collection of N linearly independent vectors.

If $\{\mathbf{v}_i\}_{i=1}^N$ is one oriented basis and $\{\mathbf{u}_i\}_{i=1}^N$ is a second one, then

$$\mathbf{u}_1 \wedge \mathbf{u}_2 \wedge \dots \wedge \mathbf{u}_N = (\det \mathbf{R}) \mathbf{v}_1 \wedge \mathbf{v}_2 \wedge \dots \wedge \mathbf{v}_N,$$

where \mathbf{R} is the transformation matrix and $\det \mathbf{R}$ is a nonzero number (\mathbf{R} is invertible), which can be positive or negative. Accordingly, we have the following definition.

oriented vector spaces defined **Definition 26.3.15** An **orientation** is the collection of all oriented bases related by a transformation matrix having a positive determinant. A vector space for which an orientation is specified is called an **oriented** vector space.

Clearly, there are only two orientations in any vector space. Each oriented basis is positively related to any oriented basis belonging to the same orientation and negatively related to any oriented basis belonging to the other orientation. For example, in \mathbb{R}^3 , the bases $\{\mathbf{e}_x, \mathbf{e}_y, \mathbf{e}_z\}$ and $\{\mathbf{e}_y, \mathbf{e}_x, \mathbf{e}_z\}$ belong to different orientations because

$$\mathbf{e}_x \wedge \mathbf{e}_y \wedge \mathbf{e}_z = -\mathbf{e}_y \wedge \mathbf{e}_x \wedge \mathbf{e}_z.$$

The first basis is (by convention) called a **right-handed** coordinate system, and the second is called a **left-handed** coordinate system. Any other basis is either right-handed or left-handed. There is no third alternative!

Definition 26.3.16 Let \mathcal{V} be a vector space. Let \mathcal{V}^* have the oriented basis $\{\epsilon^i\}_{i=1}^N$. The oriented **volume element** $\mu \in \Lambda^N(\mathcal{V})$ of \mathcal{V} is defined as

$$\mu \equiv \epsilon^1 \wedge \epsilon^2 \wedge \dots \wedge \epsilon^N.$$

volume element of a vector space

Note that if $\{\mathbf{e}_i\}$ is ordered as $\{\epsilon^j\}$, then $\mu(\mathbf{e}_1, \mathbf{e}_2, \dots, \mathbf{e}_N) = +1/N!$, and we say that $\{\mathbf{e}_i\}$ is *positively oriented* with respect to μ . In general, $\{\mathbf{v}_i\}$ is positively oriented with respect to μ if $\mu(\mathbf{v}_1, \mathbf{v}_2, \dots, \mathbf{v}_N) > 0$.

positive orientation

The volume element of \mathcal{V} is defined in terms of a basis for \mathcal{V}^* . The reason for this will become apparent later, when we see that dx, dy , and dz form a basis for $(\mathbb{R}^3)^*$, and $dx dy dz \equiv dx \wedge dy \wedge dz$.

26.4 Symplectic Vector Spaces

Mechanics was a great contributor to the development of tensor analysis. It provided examples of manifolds that went beyond mere subspaces of \mathbb{R}^n . The phase space of Hamiltonian mechanics is a paradigm of manifolds that are not “hypersurfaces” of some Euclidean space. We shall have more to say about such manifolds in Chap. 28. Here, we shall be content with the algebraic structure underlying classical mechanics.

Definition 26.4.1 A 2-form $\omega \in \Lambda^2(\mathcal{V})$ is **nondegenerate** if $\omega(\mathbf{v}_1, \mathbf{v}_2) = 0$ for all $\mathbf{v}_1 \in \mathcal{V}$ implies $\mathbf{v}_2 = 0$. A **symplectic form** on \mathcal{V} is a nondegenerate 2-form $\omega \in \Lambda^2(\mathcal{V})$. The pair (\mathcal{V}, ω) is called a **symplectic vector space**. If (\mathcal{V}, ω) and (\mathcal{W}, ρ) are symplectic vector spaces, a linear transformation $\mathbf{T} : \mathcal{V} \rightarrow \mathcal{W}$ is called a **symplectic transformation** or a **symplectic map** if $\mathbf{T}^* \rho = \omega$.

symplectic form, symplectic vector space, and symplectic transformation

Any 2-form (degenerate or nondegenerate) leads to other quantities that are also of interest. For instance, given any basis $\{\mathbf{v}_i\}$ in \mathcal{V} , one defines the **matrix** of the 2-form $\omega \in \Lambda^2(\mathcal{V})$ by $\omega_{ij} \equiv \omega(\mathbf{v}_i, \mathbf{v}_j)$. Similarly, one can define the useful linear map $\omega^\flat : \mathcal{V} \rightarrow \mathcal{V}^*$ by

The flat \flat and sharp \sharp maps defined

$$\underbrace{[\omega^\flat(\mathbf{v})]}_{\in \mathcal{V}^*} \mathbf{v}' \equiv \omega(\mathbf{v}, \mathbf{v}'). \tag{26.26}$$

The rank of ω^\flat is called the **rank** of ω . The reader may check that

rank of a symplectic form

Box 26.4.2 A 2-form ω is nondegenerate if and only if the determinant of (ω_{ij}) is nonzero, if and only if ω^\flat is an isomorphism, in which case the inverse of ω^\flat is denoted by ω^\sharp .

Proposition 26.4.3 Let \mathcal{V} be an N -dimensional vector space and $\omega \in \Lambda^2(\mathcal{V})$. If the rank of ω is r , then $r = 2n$ for some integer n and there exists

canonical basis of a symplectic vector space

a basis $\{\mathbf{e}_i\}$ of \mathcal{V} , called a **canonical basis** of \mathcal{V} , and a dual basis $\{\boldsymbol{\epsilon}^j\}$, such that $\boldsymbol{\omega} = \sum_{j=1}^n \boldsymbol{\epsilon}^j \wedge \boldsymbol{\epsilon}^{j+n}$, or, equivalently, the $N \times N$ matrix of $\boldsymbol{\omega}$ is given by

$$\begin{pmatrix} 0 & \mathbf{1} & \mathbf{0} \\ -\mathbf{1} & \mathbf{0} & \mathbf{0} \\ 0 & \mathbf{0} & \mathbf{0} \end{pmatrix}$$

where $\mathbf{1}$ is the $n \times n$ identity matrix and $\mathbf{0}$ is the $(N - 2n) \times (N - 2n)$ zero matrix.

Proof Since $\boldsymbol{\omega} \neq 0$, there exist a pair of vectors $\mathbf{e}_1, \mathbf{e}'_1 \in \mathcal{V}$ such that $\boldsymbol{\omega}(\mathbf{e}_1, \mathbf{e}'_1) \neq 0$. Dividing \mathbf{e}_1 by a constant, we can assume $\boldsymbol{\omega}(\mathbf{e}_1, \mathbf{e}'_1) = 1$. Because of its antisymmetry, the matrix of $\boldsymbol{\omega}$ in the plane \mathcal{P}_1 spanned by \mathbf{e}_1 and \mathbf{e}'_1 is $\begin{pmatrix} 0 & 1 \\ -1 & 0 \end{pmatrix}$. Let \mathcal{V}_1 be the $\boldsymbol{\omega}$ -orthogonal complement of \mathcal{P}_1 , i.e.,

$$\mathcal{V}_1 = \{\mathbf{v} \in \mathcal{V} \mid \boldsymbol{\omega}(\mathbf{v}, \mathbf{v}_1) = 0 \forall \mathbf{v}_1 \in \mathcal{P}_1\}.$$

Then the reader may check that $\mathcal{P}_1 \cap \mathcal{V}_1 = 0$. Moreover, $\mathcal{V} = \mathcal{P}_1 + \mathcal{V}_1$ because

$$\mathbf{v} = \underbrace{\boldsymbol{\omega}(\mathbf{v}, \mathbf{e}'_1)\mathbf{e}_1 - \boldsymbol{\omega}(\mathbf{v}, \mathbf{e}_1)\mathbf{e}'_1}_{\in \mathcal{P}_1} + \underbrace{\mathbf{v} - \boldsymbol{\omega}(\mathbf{v}, \mathbf{e}'_1)\mathbf{e}_1 + \boldsymbol{\omega}(\mathbf{v}, \mathbf{e}_1)\mathbf{e}'_1}_{\in \mathcal{V}_1 \text{ (Reader, verify!)}}$$

for any $\mathbf{v} \in \mathcal{V}$. Thus, $\mathcal{V} = \mathcal{P}_1 \oplus \mathcal{V}_1$. If $\boldsymbol{\omega}$ is zero on all pairs of vectors in \mathcal{V}_1 , then we are done, and the rank of $\boldsymbol{\omega}$ is 2; otherwise, let $\mathbf{e}_2, \mathbf{e}'_2 \in \mathcal{V}_1$ be such that $\boldsymbol{\omega}(\mathbf{e}_2, \mathbf{e}'_2) \neq 0$. Proceeding as above, we obtain

$$\mathcal{V}_1 = \mathcal{P}_2 \oplus \mathcal{V}_2 \quad \Rightarrow \quad \mathcal{V} = \mathcal{P}_1 \oplus \mathcal{P}_2 \oplus \mathcal{V}_2,$$

where \mathcal{P}_2 is the plane spanned by \mathbf{e}_2 , and \mathbf{e}'_2 and \mathcal{V}_2 its $\boldsymbol{\omega}$ -orthogonal complement in \mathcal{V}_1 . Continuing this process yields

$$\mathcal{V} = \mathcal{P}_1 \oplus \mathcal{P}_2 \oplus \cdots \oplus \mathcal{P}_n \oplus \mathcal{V}_n,$$

where \mathcal{V}_n is the subspace of \mathcal{V} on which $\boldsymbol{\omega}$ is zero. This shows that the rank of $\boldsymbol{\omega}$ is $2n$. By reordering the basis vectors such that $\mathbf{e}'_k \equiv \mathbf{e}_{n+k}$, we construct a new basis $\{\mathbf{e}_i\}_{i=1}^N$ in which $\boldsymbol{\omega}$ has the desired matrix.

To conclude the proposition, it is sufficient to show that $\sum_{j=1}^n \boldsymbol{\epsilon}^j \wedge \boldsymbol{\epsilon}^{j+n}$, in which $\{\boldsymbol{\epsilon}^j\}_{j=1}^N$ is dual to $\{\mathbf{e}_i\}_{i=1}^N$, has the same matrix as $\boldsymbol{\omega}$. This is left as an exercise for the reader. \square

We note that in the canonical basis,

$$\omega_{ij} = \begin{cases} 0 & \text{if } i, j \leq n, \\ \delta_{ik} & \text{if } j = n + k, k \leq n, \\ 0 & \text{if } i \geq 2n \text{ or } j \geq 2n. \end{cases}$$

If we write $\mathbf{v} \in \mathcal{V}$ as $\mathbf{v} = \sum_{i=1}^n (x_i \mathbf{e}_i + y_i \mathbf{e}_{n+i}) + \sum_{i=1}^{N-2n} z_i \mathbf{e}_{2n+i}$ in the canonical basis of \mathcal{V} , with a corresponding expansion for \mathbf{v}' , then the reader may verify that

$$\omega(\mathbf{v}, \mathbf{v}') = \sum_{i=1}^n (x_i y'_i - x'_i y_i).$$

The following proposition gives a useful criterion for nondegeneracy of ω :

Proposition 26.4.4 *Let ω be a 2-form in the finite-dimensional vector space \mathcal{V} . Then ω is nondegenerate iff \mathcal{V} has even dimension, say $2n$, and $\omega^n \equiv \omega \wedge \cdots \wedge \omega$ is a volume element of \mathcal{V} .*

Proof Suppose ω is nondegenerate. Then, ω^b is an isomorphism. Therefore, the rank of ω , an even number by Proposition 26.4.3, must equal $\dim \mathcal{V}^* = \dim \mathcal{V}$. Moreover, by taking successive powers of ω and using mathematical induction, one can show that ω^n is proportional to $\epsilon^1 \wedge \cdots \wedge \epsilon^{2n}$.

Conversely, if $\omega^n \propto \epsilon^1 \wedge \cdots \wedge \epsilon^{2n}$ is a volume element, then by Proposition 26.3.8, the $\{\epsilon^j\}$ are linearly independent. Furthermore, $\dim \mathcal{V}^*$ must equal the number of linearly independent factors in the wedge product of a volume element. Thus, $\dim \mathcal{V}^* = 2n$. But $2n$ is also the rank of ω . It follows that ω^b is onto. Since \mathcal{V} is finite-dimensional, the dimension theorem implies that ω^b is an isomorphism. \square

Example 26.4.5 Let \mathcal{V} be a vector space and \mathcal{V}^* its dual. The direct sum $\mathcal{V} \oplus \mathcal{V}^*$ can be turned into a symplectic vector space if we define $\omega \in \Lambda^2(\mathcal{V} \oplus \mathcal{V}^*)$ by

$$\omega(\mathbf{v} + \boldsymbol{\varphi}, \mathbf{v}' + \boldsymbol{\varphi}') \equiv \boldsymbol{\varphi}'(\mathbf{v}) - \boldsymbol{\varphi}(\mathbf{v}'),$$

where $\mathbf{v}, \mathbf{v}' \in \mathcal{V}$ and $\boldsymbol{\varphi}, \boldsymbol{\varphi}' \in \mathcal{V}^*$. The reader may verify that $(\mathcal{V} \oplus \mathcal{V}^*, \omega)$ is a symplectic vector space. This construction of symplectic vector spaces is closely related to Hamiltonian dynamics, to which we shall return in Chap. 28.

Suppose (\mathcal{V}, ω) and (\mathcal{W}, ρ) are $2n$ -dimensional symplectic vector spaces. Then, by Proposition 26.3.5, any symplectic map $\mathbf{T} : (\mathcal{V}, \omega) \rightarrow (\mathcal{W}, \rho)$ is volume-preserving, i.e., $(\mathbf{T}^* \rho)^n$ is a volume element of \mathcal{V} . It follows that the rank of \mathbf{T}^* is $2n$, and by Proposition 2.5.5, so is the rank of \mathbf{T} . The dimension theorem now implies that \mathbf{T} is an isomorphism. Symplectic transformations on a single vector space have an interesting property:

Proposition 26.4.6 *Let (\mathcal{V}, ω) be a symplectic vector space. Then the set of symplectic mappings $\mathbf{T} : (\mathcal{V}, \omega) \rightarrow (\mathcal{V}, \omega)$ forms a group under composition, called the **symplectic group** and denoted by $Sp(\mathcal{V}, \omega)$.*

symplectic group

Proof Clearly, $Sp(\mathcal{V}, \omega)$ is a subset of $GL(\mathcal{V})$. One need only show that the inverse of a symplectic transformation is also such a transformation and that the product of two symplectic transformations is a symplectic transformation. The details are left for the reader. \square

symplectic matrices A matrix is called symplectic if it is the representation of a symplectic transformation in a canonical basis of the underlying symplectic vector space. The reader may check that the condition for a matrix \mathbf{A} to be symplectic is $\mathbf{A}^t \mathbf{J} \mathbf{A} = \mathbf{J}$, where \mathbf{J} is the representation of $\boldsymbol{\omega}$ in the canonical basis:

$$\mathbf{J} = \begin{pmatrix} 0 & 1 \\ -1 & 0 \end{pmatrix},$$

where $\mathbf{1}$ and $\mathbf{0}$ are the $n \times n$ identity and zero matrices, respectively.

26.5 Inner Product Revisited

The inner product was defined in Chap. 2 in terms of a metric function that took two vectors as input and manufactured a number. We now know what kind of machine this is in the language of tensors.

symmetric bilinear form **Definition 26.5.1** A symmetric bilinear form \mathbf{b} on \mathcal{V} is a symmetric tensor of type $(0, 2)$.

If $\{\mathbf{e}_j\}_{j=1}^N$ is a basis of \mathcal{V} and $\{\boldsymbol{\epsilon}^i\}_{i=1}^N$ is its dual basis, then $\mathbf{b} = \frac{1}{2} b_{ij} \boldsymbol{\epsilon}^i \boldsymbol{\epsilon}^j$ (recall Einstein's summation convention), because $\boldsymbol{\epsilon}^i \boldsymbol{\epsilon}^j = \boldsymbol{\epsilon}^i \otimes \boldsymbol{\epsilon}^j + \boldsymbol{\epsilon}^j \otimes \boldsymbol{\epsilon}^i$ form a basis of $\mathcal{S}_2(\mathcal{V})$. If \mathbf{v} and \mathbf{u} are any two vectors in \mathcal{V} , then

$$\begin{aligned} \mathbf{b}(\mathbf{v}, \mathbf{u}) &= \frac{1}{2} b_{ij} (\boldsymbol{\epsilon}^i \otimes \boldsymbol{\epsilon}^j + \boldsymbol{\epsilon}^j \otimes \boldsymbol{\epsilon}^i) (v^k \mathbf{e}_k, u^m \mathbf{e}_m) \\ &= \frac{1}{2} b_{ij} v^k u^m [\boldsymbol{\epsilon}^i(\mathbf{e}_k) \boldsymbol{\epsilon}^j(\mathbf{e}_m) + \boldsymbol{\epsilon}^j(\mathbf{e}_k) \boldsymbol{\epsilon}^i(\mathbf{e}_m)] \\ &= \frac{1}{2} b_{ij} v^k u^m [\delta_k^i \delta_m^j + \delta_k^j \delta_m^i] \\ &= \frac{1}{2} b_{ij} (v^i u^j + v^j u^i) = b_{ij} v^i u^j. \end{aligned} \quad (26.27)$$

For any vector $\mathbf{v} \in \mathcal{V}$, we can write

$$\begin{aligned} \mathbf{b}(\mathbf{v}) &= \frac{1}{2} b_{ij} \boldsymbol{\epsilon}^i \boldsymbol{\epsilon}^j (\mathbf{v}) = \frac{1}{2} b_{ij} (\boldsymbol{\epsilon}^i \otimes \boldsymbol{\epsilon}^j + \boldsymbol{\epsilon}^j \otimes \boldsymbol{\epsilon}^i) (v^k \mathbf{e}_k) \\ &= \frac{1}{2} b_{ij} v^k [\boldsymbol{\epsilon}^i \boldsymbol{\epsilon}^j(\mathbf{e}_k) + \boldsymbol{\epsilon}^j \boldsymbol{\epsilon}^i(\mathbf{e}_k)] = \frac{1}{2} b_{ij} v^k [\boldsymbol{\epsilon}^i \delta_k^j + \boldsymbol{\epsilon}^j \delta_k^i] \\ &= \frac{1}{2} b_{ij} [v^j \boldsymbol{\epsilon}^i + v^i \boldsymbol{\epsilon}^j] = b_{ij} v^j \boldsymbol{\epsilon}^i = b_{ij} v^i \boldsymbol{\epsilon}^j. \end{aligned} \quad (26.28)$$

Thus, $\mathbf{b}(\mathbf{v}) \in \mathcal{V}^*$. This shows that \mathbf{b} can be thought of as a mapping from \mathcal{V} to \mathcal{V}^* , which we denote by \mathbf{b}_* and write $\mathbf{b}_* : \mathcal{V} \rightarrow \mathcal{V}^*$. For this mapping to make sense, it should not matter which factor in the symmetric product \mathbf{v} contracts with. But this is a trivial consequence of the symmetries $b_{ij} = b_{ji}$ and $\boldsymbol{\epsilon}^i \boldsymbol{\epsilon}^j = \boldsymbol{\epsilon}^j \boldsymbol{\epsilon}^i$.

Let \mathbf{v} and \mathbf{u} be any two vectors in \mathcal{V} . Let $\{\mathbf{e}_j\}_{j=1}^N$ be a basis of \mathcal{V} and $\{\boldsymbol{\epsilon}^i\}_{i=1}^N$ its dual basis. The natural pairing of \mathbf{v} and $\mathbf{b}_*(\mathbf{u})$ is given by

$$\begin{aligned} \langle \mathbf{b}_*(\mathbf{u}), \mathbf{v} \rangle &= \langle b_{ij} u^j \boldsymbol{\epsilon}^i, v^k \mathbf{e}_k \rangle = b_{ij} u^j v^k \langle \boldsymbol{\epsilon}^i, \mathbf{e}_k \rangle \\ &= b_{ij} u^j v^k \delta_k^i = b_{ij} u^j v^i = \mathbf{b}(\mathbf{u}, \mathbf{v}) = \mathbf{b}(\mathbf{v}, \mathbf{u}), \end{aligned} \quad (26.29)$$

where we used (26.27) in the last step.

The components $b_{ij} v^j$ of $\mathbf{b}_*(\mathbf{v})$ in the basis $\{\boldsymbol{\epsilon}^i\}_{i=1}^N$ of \mathcal{V}^* are denoted by v_i , so

$$\mathbf{b}_*(\mathbf{v}) = v_i \boldsymbol{\epsilon}^i, \quad \text{where } v_i = b_{ij} v^j. \quad (26.30)$$

We have thus *lowered* the index of v^j by the use of the symmetric bilinear form \mathbf{b} . In applications v_i is uniquely defined; furthermore, there is a one-to-one correspondence between v_i and v^i . This can happen if and only if the mapping $\mathbf{b}_* : \mathcal{V} \rightarrow \mathcal{V}^*$ is invertible, in which case \mathbf{b} is usually denoted by \mathbf{g} . If \mathbf{g}_* is invertible, there must exist a unique $(\mathbf{g}_*)^{-1} \equiv (\mathbf{g}^{-1})_* : \mathcal{V}^* \rightarrow \mathcal{V}$, or $\mathbf{g}^{-1} \in \mathcal{S}_2(\mathcal{V}^*) = \mathcal{S}^2(\mathcal{V})$, such that

$$\begin{aligned} v^j \mathbf{e}_j = \mathbf{v} &= (\mathbf{g}_*)^{-1} \mathbf{g}_*(\mathbf{v}) = (\mathbf{g}_*)^{-1} (v_i \boldsymbol{\epsilon}^i) = v_i (\mathbf{g}_*)^{-1} (\boldsymbol{\epsilon}^i) \\ &= v_i [(g^{-1})^{jk} \mathbf{e}_j \mathbf{e}_k] (\boldsymbol{\epsilon}^i) = v_i (g^{-1})^{jk} \underbrace{\mathbf{e}_j \mathbf{e}_k (\boldsymbol{\epsilon}^i)}_{=\delta_k^i} = v_i (g^{-1})^{ji} \mathbf{e}_j. \end{aligned}$$

Comparison of the LHS and the RHS yields $v^j = v_i (g^{-1})^{ji}$. It is customary to omit the -1 and simply write

$$v^j = g^{ji} v_i, \quad (26.31)$$

where it is understood that \mathbf{g} with upper indices is the inverse of \mathbf{g} (with lower indices).

Definition 26.5.2 An invertible bilinear form is called **nondegenerate**. A symmetric bilinear form \mathbf{g} that is nondegenerate is called an **inner product**. When there is no danger of confusion, we write $\langle \mathbf{u}, \mathbf{v} \rangle$ instead of $\mathbf{g}(\mathbf{u}, \mathbf{v})$.

nondegenerate bilinear forms and inner products

We therefore see that the presence of a nondegenerate symmetric bilinear form (or an inner product) naturally connects the vectors in \mathcal{V} and \mathcal{V}^* in a unique way. For any vector $\mathbf{v} \in \mathcal{V}$ there is a unique linear functional $\boldsymbol{\phi}_v \in \mathcal{V}^*$ given by $\boldsymbol{\phi}_v = \mathbf{g}_*(\mathbf{v})$. One can therefore identify \mathcal{V} and \mathcal{V}^* . An inner product makes a vector space **self-dual**. In particular, Proposition 5.5.12 shows that there exists a determinant function Δ_0 such that⁷

$$\Delta_0(\mathbf{v}_1, \dots, \mathbf{v}_N) \Delta_0(\mathbf{u}_1, \dots, \mathbf{u}_N) = \alpha \det(\mathbf{g}(\mathbf{v}_i, \mathbf{u}_j)). \quad (26.32)$$

This is called the **Lagrange identity**.

Lagrange identity

Going from a vector in \mathcal{V} to its unique image in \mathcal{V}^* is done by simply **lowering the index** using Eq. (26.30), and going the other way involves using Eq. (26.31) to **raise the index**. This process can be generalized to

raising and lowering indices

⁷See also Problem 5.37.

all tensors. For instance, although in general, there is no connection among $\mathcal{T}_0^2(\mathcal{V})$, $\mathcal{T}_1^1(\mathcal{V})$, and $\mathcal{T}_2^0(\mathcal{V})$, the introduction of an inner product connects all these spaces in a natural way and establishes a one-to-one correspondence among them. Thus, to a tensor in $\mathcal{T}_0^2(\mathcal{V})$ with components t^{ij} there corresponds a unique tensor in $\mathcal{T}_1^1(\mathcal{V})$, given, in component form, by $t_j^i = g_{jk}t^{ik}$, and another unique tensor in $\mathcal{T}_2^0(\mathcal{V})$, given by $t_{ij} = g_{il}t_j^l = g_{il}g_{jk}t^{lk}$.

Let us apply this technique to g^{ij} , which is also a tensor and for which the lowering process is defined. We have

$$g_j^i = g_{ik}g^{kj} = (g^{-1})^{ik}g_{kj} = \delta_j^i. \quad (26.33)$$

This relation holds, of course, in all bases.

The inner product has been defined as a nondegenerate symmetric bilinear form. The important criterion of nondegeneracy has equivalences:

Proposition 26.5.3 *A symmetric bilinear form \mathbf{g} is nondegenerate if and only if*

1. *the matrix of components g_{ij} has a nonvanishing determinant, or*
2. *for every nonzero $\mathbf{v} \in \mathcal{V}$, there exists $\mathbf{w} \in \mathcal{V}$ such that $\mathbf{g}(\mathbf{v}, \mathbf{w}) \neq 0$.*

Proof The first part is a direct consequence of the definition of nondegeneracy. The second part follows from the fact that $\mathbf{g}_* : \mathcal{V} \rightarrow \mathcal{V}^*$ is invertible iff the nullity of \mathbf{g}_* is zero. It follows that if $\mathbf{v} \in \mathcal{V}$ is nonzero, then $\mathbf{g}_*(\mathbf{v}) \neq 0$, i.e., $\mathbf{g}_*(\mathbf{v})$ is not the zero functional. Thus, there must exist a vector $\mathbf{w} \in \mathcal{V}$ such that $[\mathbf{g}_*(\mathbf{v})](\mathbf{w}) \neq 0$. The proposition is proved once we note that $[\mathbf{g}_*(\mathbf{v})](\mathbf{w}) \equiv \mathbf{g}(\mathbf{v}, \mathbf{w})$. \square

Let $(\mathcal{V}, \mathbf{g})$ and $(\mathcal{U}, \mathbf{h})$ be inner product spaces. Recall that an isometry is a linear transformation $\mathbf{T} : \mathcal{V} \rightarrow \mathcal{U}$ which preserves the inner product, i.e.,

$$\mathbf{g}(\mathbf{v}_1, \mathbf{v}_2) = \mathbf{h}(\mathbf{T}\mathbf{v}_1, \mathbf{T}\mathbf{v}_2).$$

It was shown in Theorem 2.3.12 that an isometry is injective. However, the proof relied on the positive definiteness of the inner product. That is not necessary. In fact, suppose that $\mathbf{T}\mathbf{v} = \mathbf{0}$. Then, for any $\mathbf{x} \in \mathcal{V}$, we have

$$\mathbf{g}(\mathbf{x}, \mathbf{v}) = \mathbf{h}(\mathbf{T}\mathbf{x}, \mathbf{T}\mathbf{v}) = \mathbf{h}(\mathbf{T}\mathbf{x}, \mathbf{0}) = 0.$$

By Proposition 26.5.3, $\mathbf{v} = \mathbf{0}$ since \mathbf{g} is nondegenerate. It follows that $\ker \mathbf{T} = \{\mathbf{0}\}$, and we have

Theorem 26.5.4 *A linear isometry is injective for all inner products.*

g-transpose **Definition 26.5.5** The *g*-transpose of a linear endomorphism $\mathbf{T} : \mathcal{V} \rightarrow \mathcal{V}$ is the endomorphism \mathbf{T}' given by

$$\mathbf{g}(\mathbf{T}'\mathbf{u}, \mathbf{v}) = \mathbf{g}(\mathbf{u}, \mathbf{T}\mathbf{v}).$$

If \mathbf{T} is an isometry, then

$$\mathbf{g}(\mathbf{u}, \mathbf{v}) = \mathbf{g}(\mathbf{T}\mathbf{u}, \mathbf{T}\mathbf{v}) = \mathbf{g}(\mathbf{T}'\mathbf{T}\mathbf{u}, \mathbf{v}).$$

Since this holds for arbitrary \mathbf{u} and \mathbf{v} , we must have $\mathbf{T}'\mathbf{T} = \mathbf{1}$. Thus,

Proposition 26.5.6 *An endomorphism $\mathbf{T} : \mathcal{V} \rightarrow \mathcal{V}$ is an isometry if and only if $\mathbf{T}' = \mathbf{T}^{-1}$.*

Proof It is easy to show that if $\mathbf{T}' = \mathbf{T}^{-1}$, then \mathbf{T} is an isometry. We have also shown that if $\mathbf{g}(\mathbf{u}, \mathbf{v}) = \mathbf{g}(\mathbf{T}\mathbf{u}, \mathbf{T}\mathbf{v})$, then $\mathbf{T}'\mathbf{T} = \mathbf{1}$. This last relation by itself does not imply that \mathbf{T} has an inverse. However, if \mathcal{V} is finite dimensional, then it does. (See Problem 5.25.) \square

Definition 26.5.7 A symmetric bilinear form \mathbf{b} can be categorized as follows:

1. **positive (negative) definite:** $\mathbf{b}(\mathbf{v}, \mathbf{v}) > 0$ [$\mathbf{b}(\mathbf{v}, \mathbf{v}) < 0$] for every nonzero vector \mathbf{v} ;
2. **definite:** \mathbf{b} is either positive definite or negative definite;
3. **positive (negative) semidefinite:** $\mathbf{b}(\mathbf{v}, \mathbf{v}) \geq 0$ [$\mathbf{b}(\mathbf{v}, \mathbf{v}) \leq 0$] for every \mathbf{v} ;
4. **semidefinite:** \mathbf{b} is either positive semidefinite or negative semidefinite;
5. **indefinite:** \mathbf{b} is not definite.

If \mathbf{b} is a symmetric bilinear form on \mathcal{V} , then the restriction $\mathbf{b}|_{\mathcal{W}}$ of \mathbf{b} on a subspace \mathcal{W} is also symmetric and bilinear, and if \mathbf{b} is definite or semidefinite, then so is $\mathbf{b}|_{\mathcal{W}}$.

Definition 26.5.8 The **index** ν of a symmetric bilinear form \mathbf{b} on \mathcal{V} is the dimension of the largest subspace \mathcal{W} of \mathcal{V} on which $\mathbf{b}|_{\mathcal{W}}$ is negative definite. Sometimes ν is referred to as the index of \mathcal{V} .

Example 26.5.9 Some of the categories of the definition above can be illustrated in \mathbb{R}^2 with $\mathbf{v}_1 = (x_1, y_1)$, $\mathbf{v}_2 = (x_2, y_2)$, and $\mathbf{v} = (x, y)$.

- (a) Positive definite: $\mathbf{b}(\mathbf{v}_1, \mathbf{v}_2) = x_1x_2 + y_1y_2$ because if $\mathbf{v} \neq \mathbf{0}$, then one of its components is nonzero, and $\mathbf{b}(\mathbf{v}, \mathbf{v}) = x^2 + y^2 > 0$.
- (b) Negative definite: $\mathbf{b}(\mathbf{v}_1, \mathbf{v}_2) = \frac{1}{2}(x_1y_2 + x_2y_1) - x_1x_2 - y_1y_2$ because

$$\mathbf{b}(\mathbf{v}, \mathbf{v}) = xy - x^2 - y^2 = -\frac{1}{2}(x - y)^2 - \frac{1}{2}x^2 - \frac{1}{2}y^2,$$

which is negative for nonzero \mathbf{v} .

- (c) Indefinite: $\mathbf{b}(\mathbf{v}_1, \mathbf{v}_2) = x_1x_2 - y_1y_2$. For $\mathbf{v} = (x, x)$, $\mathbf{b}(\mathbf{v}, \mathbf{v}) = 0$. However, \mathbf{b} is nondegenerate, because it has the invertible matrix $\mathbf{g} = \begin{pmatrix} 1 & 0 \\ 0 & -1 \end{pmatrix}$ in the standard basis of \mathbb{R}^2 .
- (d) Positive semidefinite: $\mathbf{b}(\mathbf{v}_1, \mathbf{v}_2) = x_1x_2 \Rightarrow \mathbf{b}(\mathbf{v}, \mathbf{v}) = x^2$ and $\mathbf{b}(\mathbf{v}, \mathbf{v})$ is never negative. However, \mathbf{b} is degenerate because its matrix in the standard basis of \mathbb{R}^2 is $\mathbf{b} = \begin{pmatrix} 1 & 0 \\ 0 & 0 \end{pmatrix}$, which is not invertible.

g -orthogonal and null or isotropic vectors

Let \mathbf{g} be an inner product on \mathcal{V} . Two vectors $\mathbf{u}, \mathbf{v} \in \mathcal{V}$ are said to be g -orthogonal if $\mathbf{g}(\mathbf{u}, \mathbf{v}) = 0$. A null or isotropic vector of \mathbf{g} is a vector that is g -orthogonal to itself. If \mathbf{g} is definite, then the only null vector is the zero vector. The converse is also true, as the following proposition shows.

Proposition 26.5.10 *If \mathbf{g} is not definite, then there exists a nonzero isotropic vector.*

Proof That \mathbf{g} is not positive definite implies that there exists a nonzero vector $\mathbf{v} \in \mathcal{V}$ such that $\mathbf{g}(\mathbf{v}, \mathbf{v}) \leq 0$. Similarly, that \mathbf{g} is not negative definite implies that there exists a nonzero vector $\mathbf{w} \in \mathcal{V}$ such that $\mathbf{g}(\mathbf{w}, \mathbf{w}) \geq 0$. Construct the vector $\mathbf{u} = \alpha\mathbf{v} + (1 - \alpha)\mathbf{w}$ and note that $\mathbf{g}(\mathbf{u}, \mathbf{u})$ is a continuous function of α . For $\alpha = 0$ this function has the value $\mathbf{g}(\mathbf{w}, \mathbf{w}) \geq 0$, and for $\alpha = 1$ it has the value $\mathbf{g}(\mathbf{v}, \mathbf{v}) \leq 0$. Thus, there must be some α for which $\mathbf{g}(\mathbf{u}, \mathbf{u}) = 0$. \square

Example 26.5.11 In the special theory of relativity, the inner product of two “position” four-vectors, $\mathbf{r}_1 = (x_1, y_1, z_1, ct_1)$ and $\mathbf{r}_2 = (x_2, y_2, z_2, ct_2)$, where c is the speed of light, is defined as

$$\mathbf{g}(\mathbf{r}_1, \mathbf{r}_2) = -x_1x_2 - y_1y_2 - z_1z_2 + c^2t_1t_2.$$

This is clearly an indefinite symmetric bilinear form. Proposition 26.5.10 tells us that there must exist a nonzero null vector. Such a vector \mathbf{r} satisfies

$$\mathbf{g}(\mathbf{r}, \mathbf{r}) = c^2t^2 - x^2 - y^2 - z^2 = 0,$$

or

$$c^2 = \frac{x^2 + y^2 + z^2}{t^2} \Rightarrow c = \pm \frac{\sqrt{x^2 + y^2 + z^2}}{t} = \pm \frac{\text{distance}}{\text{time}}.$$

This corresponds to a particle moving with the speed of light. Thus, light rays are the null vectors in the special theory of relativity.

Considering the four-vectors as a generalization of three-vectors, it is more natural to define the inner product as $\mathbf{g}(\mathbf{r}_1, \mathbf{r}_2) = x_1x_2 + y_1y_2 + z_1z_2 - c^2t_1t_2$, so that the Euclidean part remains positive and only the added 4th dimension carries the negative sign. Both practices are common in physics, and we shall use both of them in the book.

As in Chap. 4, we define the component of a vector along another vector and the reflection of the former in a plane perpendicular to the latter.

Definition 26.5.12 Let \mathbf{g} be an inner product on \mathcal{V} and \mathbf{y} a non-null (non-isotropic) vector in \mathcal{V} . The projection \mathbf{x}_y of \mathbf{x} along \mathbf{y} and the reflection for \mathbf{g} $\mathbf{x}_{r,y}$ of \mathbf{x} in a plane perpendicular to \mathbf{y} are given by

$$\mathbf{x}_y = \frac{\mathbf{g}(\mathbf{x}, \mathbf{y})}{\mathbf{g}(\mathbf{y}, \mathbf{y})}\mathbf{y} \quad \text{and} \quad \mathbf{x}_{r,y} = \mathbf{x} - 2\frac{\mathbf{g}(\mathbf{x}, \mathbf{y})}{\mathbf{g}(\mathbf{y}, \mathbf{y})}\mathbf{y}.$$

We can also introduce operators, as we did in Chap. 4. The bra and ket notation was suitable for the projection operators. However, we still can construct projection and reflection operators. In fact, using \mathbf{g}_* and recalling that $\phi_y = \mathbf{g}_*(\mathbf{y})$ is the linear functional such that $\phi_y(\mathbf{x}) = \mathbf{g}(\mathbf{x}, \mathbf{y})$, we can define

$$\mathbf{P}_y = \mathbf{y} \frac{1}{\mathbf{g}(\mathbf{y}, \mathbf{y})} \phi_y \quad (26.34)$$

and verify that

$$\begin{aligned} \mathbf{P}_y^2 &= \left(\mathbf{y} \frac{1}{\mathbf{g}(\mathbf{y}, \mathbf{y})} \phi_y \right) \left(\mathbf{y} \frac{1}{\mathbf{g}(\mathbf{y}, \mathbf{y})} \phi_y \right) = \mathbf{y} \frac{1}{\mathbf{g}(\mathbf{y}, \mathbf{y})} \phi_y(\mathbf{y}) \frac{1}{\mathbf{g}(\mathbf{y}, \mathbf{y})} \phi_y \\ &= \mathbf{y} \frac{1}{\mathbf{g}(\mathbf{y}, \mathbf{y})} \mathbf{g}(\mathbf{y}, \mathbf{y}) \frac{1}{\mathbf{g}(\mathbf{y}, \mathbf{y})} \phi_y = \mathbf{y} \frac{1}{\mathbf{g}(\mathbf{y}, \mathbf{y})} \phi_y = \mathbf{P}_y. \end{aligned}$$

From this we obtain the reflection operator

$$\mathbf{R}_y = \mathbf{1} - 2\mathbf{P}_y = \mathbf{1} - 2\mathbf{y} \frac{1}{\mathbf{g}(\mathbf{y}, \mathbf{y})} \phi_y. \quad (26.35)$$

The reflection operator has the property $\mathbf{R}_y^2 = \mathbf{1}$, or $\mathbf{R}_y^{-1} = \mathbf{R}_y$, as expected. Furthermore, one can easily show that

$$\mathbf{g}(\mathbf{x}, \mathbf{P}_y \mathbf{z}) = \mathbf{g}(\mathbf{z}, \mathbf{P}_y \mathbf{x}) = \frac{\mathbf{g}(\mathbf{x}, \mathbf{y}) \mathbf{g}(\mathbf{z}, \mathbf{y})}{\mathbf{g}(\mathbf{y}, \mathbf{y})},$$

indicating that \mathbf{P}_y is symmetric (i.e., $\mathbf{P}_y^t = \mathbf{P}_y$). It follows that \mathbf{R}_y is also symmetric and

$$\mathbf{1} = \mathbf{R}_y^2 = \mathbf{R}_y^t \mathbf{R}_y, \quad (26.36)$$

i.e., that \mathbf{R}_y is an isometry by Proposition 26.5.6.

26.5.1 Subspaces

Let \mathcal{V} be a vector space with inner product \mathbf{g} . Let \mathcal{W} be a subspace of \mathcal{V} . Let \mathcal{W}^\perp be all vectors in \mathcal{V} which are \mathbf{g} -orthogonal to all vectors in \mathcal{W} . Ordinarily, we would call \mathcal{W}^\perp the orthogonal *complement* of \mathcal{W} , but if \mathbf{g} is not definite, we can't. Here is why: In Example 26.5.11, eliminate the y and z coordinates and consider two-dimensional vectors (x, ct) . Now let \mathcal{W} be the span of any null vector. Then clearly $\mathcal{W} = \mathcal{W}^\perp$, and \mathcal{W}^\perp does not complement \mathcal{W} . Nevertheless, we have the following

Lemma 26.5.13 *Let \mathcal{W} be a subspace of a finite-dimensional inner product space \mathcal{V} . Then*

- (1) $\dim \mathcal{W} + \dim \mathcal{W}^\perp = \dim \mathcal{V}$.
- (2) $(\mathcal{W}^\perp)^\perp = \mathcal{W}$.

Proof (1) Let $\{\mathbf{e}_i\}_{i=1}^m$ be a basis of \mathcal{W} with the dual basis $\{\boldsymbol{\epsilon}^i\}_{i=1}^m$. Consider the linear operator $\mathbf{g}_W : \mathcal{V} \rightarrow \mathcal{W}^*$ given by

$$\mathbf{g}_W(\mathbf{v}) = \sum_{i=1}^m \mathbf{g}(\mathbf{v}, \mathbf{e}_i) \boldsymbol{\epsilon}^i.$$

It is not hard to show that \mathbf{g}_W is onto. Using the dimension theorem (Theorem 2.3.13), we can write

$$\dim \mathcal{W}^* + \dim \ker \mathbf{g}_W = \dim \mathcal{V}.$$

Since $\dim \mathcal{W}^* = \dim \mathcal{W}$, all that is left to show is that $\dim \ker \mathbf{g}_W = \dim \mathcal{W}^\perp$. We show more than that; we prove that $\ker \mathbf{g}_W = \mathcal{W}^\perp$. In fact,

$$\begin{aligned} \mathbf{v} \in \ker \mathbf{g}_W &\iff \sum_{i=1}^m \mathbf{g}(\mathbf{v}, \mathbf{e}_i) \boldsymbol{\epsilon}^i = \mathbf{0} \\ &\iff \mathbf{g}(\mathbf{v}, \mathbf{e}_i) = 0, \quad i = 1, 2, \dots, m. \end{aligned}$$

The last equality follows from the linear independence of $\{\boldsymbol{\epsilon}^i\}_{i=1}^m$, and it holds if and only if $\mathbf{v} \in \mathcal{W}^\perp$.

(2) If $\mathbf{v} \in \mathcal{W}$, then \mathbf{v} is orthogonal to all vectors in \mathcal{W}^\perp , i.e., $\mathbf{v} \in (\mathcal{W}^\perp)^\perp$. Thus, $\mathcal{W} \subset (\mathcal{W}^\perp)^\perp$. Applying (1) to the subspace \mathcal{W}^\perp , we get $\dim \mathcal{W}^\perp + \dim (\mathcal{W}^\perp)^\perp = \dim \mathcal{V}$. Hence, $\dim \mathcal{W} = \dim (\mathcal{W}^\perp)^\perp$, and $\mathcal{W} = (\mathcal{W}^\perp)^\perp$. \square

nondegenerate
subspace

A subspace \mathcal{W} of an inner product space $(\mathcal{V}, \mathbf{g})$ is called **nondegenerate** if $\mathbf{g}|_{\mathcal{W}}$ is nondegenerate. When \mathbf{g} is definite, any subspace of \mathcal{V} inherits a definite inner product. Therefore, in this case every subspace is nondegenerate. However, when \mathbf{g} is not definite, there will always be degenerate subspaces. For example, if v is null, then the span of v is clearly degenerate.

Proposition 26.5.14 *A subspace \mathcal{W} of an inner product space \mathcal{V} is nondegenerate if and only if $\mathcal{W} \oplus \mathcal{W}^\perp = \mathcal{V}$.*

Proof Clearly, $\mathbf{g}|_{\mathcal{W}}$ is nondegenerate if and only if $\mathcal{W} \cap \mathcal{W}^\perp = \{0\}$, because if there were $0 \neq w \in \mathcal{W} \cap \mathcal{W}^\perp$, it would have to be orthogonal to *all* vectors in \mathcal{W} , making $\mathbf{g}|_{\mathcal{W}}$ degenerate. From Problem 2.8, we have

$$\dim(\mathcal{W} + \mathcal{W}^\perp) + \dim(\mathcal{W} \cap \mathcal{W}^\perp) = \dim \mathcal{W} + \dim \mathcal{W}^\perp = \dim \mathcal{V},$$

where in the last step, we used (1) of Lemma 26.5.13. Therefore, $\dim(\mathcal{W} + \mathcal{W}^\perp) = \dim \mathcal{V}$ if and only if \mathcal{W} is nondegenerate. Since $\mathcal{W} + \mathcal{W}^\perp$ is a subspace of \mathcal{V} , we get $\mathcal{W} + \mathcal{W}^\perp = \mathcal{V}$ if and only if \mathcal{W} is nondegenerate. The last sum is actually a direct sum because of the first statement in the proof. \square

An immediate consequence of this proposition and (2) of Lemma 26.5.13 is

Corollary 26.5.15 *A subspace \mathcal{W} of an inner product space is nondegenerate if and only if \mathcal{W}^\perp is nondegenerate.*

Equation (26.36) tells us that a reflection is an isometry. Is an isometry also a reflection? This question is not without merit. In fact, Example 4.4.8 established a connection between reflections and isometries in \mathbb{R}^2 . Geometric reasonings also make a connection between reflections and isometries. Take a vector in three dimensions and apply an isometry to it. The resulting vector will have the same length. Draw the two vectors from the same point. Find the difference between the two vectors (connect the tips of the two arrows). Construct the perpendicular bisector plane of this vector. Clearly the vector and its isometric image are reflections of one another in this plane. Although we have constructed a reflection from the isometry, its construction depends on the vector on which the isometry acts (see Problem 26.28). Is it possible to find a general dependence between an isometry and reflections not involving any vector? The theorem to follow makes the relation more explicit, but first we need a lemma:

Lemma 26.5.16 *Let \mathbf{x} and \mathbf{y} be two vectors in \mathcal{V} such that $\mathbf{g}(\mathbf{x}, \mathbf{x}) = \mathbf{g}(\mathbf{y}, \mathbf{y}) \neq 0$. Then there is a reflection \mathbf{R} such that $\mathbf{R}(\mathbf{x}) = \pm\mathbf{y}$.*

Proof Because of the relation

$$\mathbf{g}(\mathbf{x} + \mathbf{y}, \mathbf{x} + \mathbf{y}) + \mathbf{g}(\mathbf{x} - \mathbf{y}, \mathbf{x} - \mathbf{y}) = 4\mathbf{g}(\mathbf{x}, \mathbf{x}) \neq 0,$$

at least one of the terms on the left is nonzero. Assume that $\mathbf{g}(\mathbf{x} - \mathbf{y}, \mathbf{x} - \mathbf{y}) \neq 0$, and let $\mathbf{z} = \mathbf{x} - \mathbf{y}$. Then the reflection operator

$$\mathbf{R}_z = \mathbf{1} - 2\mathbf{P}_z = \mathbf{1} - 2z \frac{1}{\mathbf{g}(z, z)} \phi_z$$

is such that

$$\begin{aligned} \mathbf{R}_z(\mathbf{x}) &= \mathbf{x} - 2z \frac{\mathbf{g}(z, \mathbf{x})}{\mathbf{g}(z, z)} = \mathbf{x} - 2(\mathbf{x} - \mathbf{y}) \frac{\mathbf{g}(\mathbf{x} - \mathbf{y}, \mathbf{x})}{\mathbf{g}(\mathbf{x} - \mathbf{y}, \mathbf{x} - \mathbf{y})} \\ &= \mathbf{x} - 2(\mathbf{x} - \mathbf{y}) \frac{\mathbf{g}(\mathbf{x}, \mathbf{x}) - \mathbf{g}(\mathbf{x}, \mathbf{y})}{2\mathbf{g}(\mathbf{x}, \mathbf{x}) - 2\mathbf{g}(\mathbf{x}, \mathbf{y})} = \mathbf{y}. \end{aligned}$$

If $\mathbf{g}(\mathbf{x} + \mathbf{y}, \mathbf{x} + \mathbf{y}) \neq 0$, then let $\mathbf{z} = \mathbf{x} + \mathbf{y}$. The reflection operator \mathbf{R}_z , when acting on \mathbf{x} , yields

$$\begin{aligned} \mathbf{R}_z(\mathbf{x}) &= \mathbf{x} - 2z \frac{\mathbf{g}(z, \mathbf{x})}{\mathbf{g}(z, z)} = \mathbf{x} - 2(\mathbf{x} + \mathbf{y}) \frac{\mathbf{g}(\mathbf{x} + \mathbf{y}, \mathbf{x})}{\mathbf{g}(\mathbf{x} + \mathbf{y}, \mathbf{x} + \mathbf{y})} \\ &= \mathbf{x} - 2(\mathbf{x} + \mathbf{y}) \frac{\mathbf{g}(\mathbf{x}, \mathbf{x}) + \mathbf{g}(\mathbf{x}, \mathbf{y})}{2\mathbf{g}(\mathbf{x}, \mathbf{x}) + 2\mathbf{g}(\mathbf{x}, \mathbf{y})} = -\mathbf{y}, \end{aligned}$$

and the proof of the lemma is complete. \square

Theorem 26.5.17 *Let \mathcal{V} be an N -dimensional inner product space. Then any isometry \mathbf{T} of \mathcal{V} is the product of at most $N + 1$ reflections.*

Proof We prove the theorem by induction on the dimension of \mathcal{V} . For $N = 1$ and $\mathbf{x} \in \mathcal{V}$, we have $\mathbf{T}\mathbf{x} = \pm\mathbf{x}$. Since $\mathbf{R} = -\mathbf{1}$ for any reflection operator in one-dimension, we see that $\mathbf{T} = \mathbf{R}$ for the negative sign, and $\mathbf{T} = \mathbf{R}^2$ for the positive sign. Hence, \mathbf{T} is the product of at most two reflections.

Now let \mathbf{T} be an isometry of \mathcal{V} . Choose a vector \mathbf{x} such that $\mathbf{g}(\mathbf{x}, \mathbf{x}) \neq 0$, and set $\mathbf{y} = \mathbf{T}\mathbf{x}$. Since $\mathbf{g}(\mathbf{y}, \mathbf{y}) = \mathbf{g}(\mathbf{x}, \mathbf{x})$, by Lemma 26.5.16, there exists a reflection \mathbf{R} such that $\mathbf{R}\mathbf{x} = \pm\mathbf{y}$. Set $\mathbf{T}_1 = \mathbf{R} \circ \mathbf{T}$ and note that

$$\mathbf{T}_1\mathbf{x} = \mathbf{R} \circ \mathbf{T}\mathbf{x} = \mathbf{R}\mathbf{y} = \pm\mathbf{R}^2\mathbf{x} = \pm\mathbf{x}.$$

So \mathbf{T}_1 leaves $\text{Span}\{\mathbf{x}\}$ invariant. By Propositions 2.3.17 and 2.3.21, it leaves \mathcal{V}_1 , the orthogonal complement of $\text{Span}\{\mathbf{x}\}$, also invariant. Since $\text{Span}\{\mathbf{x}\}$ is non-degenerate, so is \mathcal{V}_1 by Corollary 26.5.15. Furthermore, since \mathcal{V}_1 has dimension $N - 1$, the induction hypothesis applies to it, and we can write

$$\mathbf{R} \circ \mathbf{T} \equiv \mathbf{T}_1 = \mathbf{R}_1\mathbf{R}_2 \dots \mathbf{R}_N, \quad (26.37)$$

where each \mathbf{R}_i is a reflection in \mathcal{V}_1 .

Now, each reflection in \mathcal{V}_1 extends to a reflection in \mathcal{V} . In fact, if \mathbf{R}_{z_1} is defined for $\mathbf{z}_1 \in \mathcal{V}_1$, and $\mathbf{v} = \mathbf{v}_1 + \alpha\mathbf{x}$ is any vector in \mathcal{V} , define $\mathbf{R}_{z_1}\mathbf{v} = \mathbf{R}_{z_1}\mathbf{v}_1 + \alpha\mathbf{x}$. Then

$$\begin{aligned} \mathbf{R}_{z_1}\mathbf{v} &= \mathbf{v}_1 - 2z_1 \frac{\mathbf{g}(z_1, \mathbf{v}_1)}{\mathbf{g}(z_1, z_1)} + \alpha\mathbf{x} \\ &= \mathbf{v}_1 + \alpha\mathbf{x} - 2z_1 \frac{\mathbf{g}(z_1, \mathbf{v}_1 + \alpha\mathbf{x})}{\mathbf{g}(z_1, z_1)} = \mathbf{v} - 2z_1 \frac{\mathbf{g}(z_1, \mathbf{v})}{\mathbf{g}(z_1, z_1)}, \end{aligned}$$

because $\mathbf{g}(z_1, \mathbf{x}) = 0$. This shows that \mathbf{R}_{z_1} is a reflection in \mathcal{V} . Multiplying both sides of (26.37) by \mathbf{R} and noting that $\mathbf{R}^2 = \mathbf{1}$, we get

$$\mathbf{T} = \mathbf{R}^2 \circ \mathbf{T} = \mathbf{R} \circ \mathbf{T}_1 = \mathbf{R}\mathbf{R}_1\mathbf{R}_2 \dots \mathbf{R}_N.$$

Thus \mathbf{T} is the product of \mathbf{R} and N other reflections. □

26.5.2 Orthonormal Basis

Whenever there is an inner product on a vector space, there is the possibility of orthogonal basis vectors. Since, in general, $\mathbf{g}(\mathbf{v}, \mathbf{v})$ is allowed to be negative or zero, we have to redefine what we mean by a vector of norm 1. If $\mathbf{g}(\mathbf{v}, \mathbf{v}) \neq 0$, we define the norm of \mathbf{v} as $\|\mathbf{v}\| = |\sqrt{\mathbf{g}(\mathbf{v}, \mathbf{v})}|$. A *unit* vector, or a vector of norm 1 obtained from \mathbf{v} is simply $\mathbf{v}/\|\mathbf{v}\|$.

Theorem 26.5.18 *An inner product space \mathcal{V} has an orthonormal basis.*

polarization identity *Proof* Start with the **polarization identity**,

$$\mathbf{g}(\mathbf{v}, \mathbf{v}') = \frac{1}{4}[\mathbf{g}(\mathbf{v} + \mathbf{v}', \mathbf{v} + \mathbf{v}') - \mathbf{g}(\mathbf{v} - \mathbf{v}', \mathbf{v} - \mathbf{v}')],$$

and use it to convince yourself that \mathbf{g} is identically zero unless there exists a vector \mathbf{v} such that $\mathbf{g}(\mathbf{v}, \mathbf{v}) \neq 0$. Let $\mathbf{e}_1 = \mathbf{v}/\|\mathbf{v}\|$, and note that $\mathbf{g}(\mathbf{e}_1, \mathbf{e}_1) \equiv \eta_{11} = \pm 1$. Now suppose that we have found a set $\{\mathbf{e}_i\}_{i=1}^m$ of m orthonormal vectors in \mathcal{V} . We show that as long as $m < \dim \mathcal{V}$, we can add one more unit vector to the set. Let \mathcal{W} be the subspace spanned by $\{\mathbf{e}_i\}_{i=1}^m$. Then \mathcal{W} is nondegenerate, and by Corollary 26.5.15, \mathcal{W}^\perp is also nondegenerate. Hence, there exist a vector $\mathbf{u} \in \mathcal{W}^\perp$ with $\mathbf{g}(\mathbf{u}, \mathbf{u}) \neq 0$, and $\mathbf{e}_{m+1} \equiv \mathbf{u}/\|\mathbf{u}\|$ is a unit vector orthogonal to all vectors $\{\mathbf{e}_i\}_{i=1}^m$. \square

Definition 26.5.19 Let $B = \{\mathbf{e}_i\}_{i=1}^N$ be a basis of \mathcal{V} and $\eta_{ij} \equiv \mathbf{g}(\mathbf{e}_i, \mathbf{e}_j)$. We say B is *g-orthonormal* if $\eta_{ij} = 0$ for $i \neq j$, and $\eta_{ii} = \pm 1$. The η_{ii} are called the **diagonal components** of \mathbf{g} . We use n_+ and n_- to denote the number of vectors \mathbf{e}_i for which η_{ii} is, respectively, $+1$ and -1 . The collection $(\eta_{11}, \eta_{22}, \dots, \eta_{NN})$ is called the **signature** of \mathbf{g} .

g-orthonormal vectors, diagonal components of \mathbf{g} , and signature of \mathbf{g}

Example 26.5.20 Let $\mathcal{V} = \mathbb{R}^3$ and $\mathbf{v}_1 = (x_1, y_1, z_1)$, $\mathbf{v}_2 = (x_2, y_2, z_2)$, and $\mathbf{v} = (x, y, z)$. Define the symmetric bilinear form

$$\mathbf{g}(\mathbf{v}_1, \mathbf{v}_2) = \frac{1}{2}(x_1y_2 + x_2y_1 + y_1z_2 + y_2z_1 + x_1z_2 + x_2z_1)$$

so that $\mathbf{g}(\mathbf{v}, \mathbf{v}) = xy + yz + xz$. We wish to find a set of vectors in \mathbb{R}^3 that are orthonormal with respect to this bilinear form. Clearly, $\mathbf{e}_1 = (1, 1, 0)$ is such that $\mathbf{g}(\mathbf{e}_1, \mathbf{e}_1) = 1$. So \mathbf{e}_1 is one of our vectors. Consider $\mathbf{v} = (1, 0, 1)$ and note that the vector $\mathbf{r}_2 = \mathbf{v} - [\mathbf{g}(\mathbf{v}, \mathbf{e}_1)/\mathbf{g}(\mathbf{e}_1, \mathbf{e}_1)]\mathbf{e}_1$, suggested by the Gram–Schmidt process, is orthogonal to \mathbf{e}_1 . Furthermore, it is easily verified that $\mathbf{g}(\mathbf{r}_2, \mathbf{r}_2) = -\frac{5}{4}$. Therefore, our second vector is

$$\mathbf{e}_2 = \frac{\mathbf{r}_2}{\sqrt{|\mathbf{g}(\mathbf{r}_2, \mathbf{r}_2)|}} = \left(-\frac{1}{\sqrt{5}}, -\frac{3}{\sqrt{5}}, \frac{2}{\sqrt{5}}\right)$$

with $\mathbf{g}(\mathbf{e}_2, \mathbf{e}_2) = -1$. Finally, we take $\mathbf{w} = (0, 1, 1)$. Then

$$\mathbf{r}_3 = \mathbf{w} - \frac{\mathbf{g}(\mathbf{w}, \mathbf{e}_1)}{\mathbf{g}(\mathbf{e}_1, \mathbf{e}_1)}\mathbf{e}_1 - \frac{\mathbf{g}(\mathbf{w}, \mathbf{e}_2)}{\mathbf{g}(\mathbf{e}_2, \mathbf{e}_2)}\mathbf{e}_2 = \frac{4}{10}(-3, 1, 1)$$

will be orthogonal to both \mathbf{e}_1 and \mathbf{e}_2 with $\mathbf{g}(\mathbf{r}_3, \mathbf{r}_3) = -\frac{4}{5}$. Thus, the third vector can be chosen to be

$$\mathbf{e}_3 = \frac{\mathbf{r}_3}{\sqrt{|\mathbf{g}(\mathbf{r}_3, \mathbf{r}_3)|}} = \left(-\frac{3}{\sqrt{5}}, \frac{1}{\sqrt{5}}, \frac{1}{\sqrt{5}}\right),$$

and we obtain $\mathbf{g}(\mathbf{e}_1, \mathbf{e}_1) = 1$, $\mathbf{g}(\mathbf{e}_2, \mathbf{e}_2) = -1$, $\mathbf{g}(\mathbf{e}_3, \mathbf{e}_3) = -1$, $\mathbf{g}(\mathbf{e}_i, \mathbf{e}_j) = 0$ for $i \neq j$. We also have $n_+ = 1$, $n_- = 2$. Although we have worked in a particular basis, Theorem 26.5.21 below guarantees that n_+ and n_- are (orthonormal) basis-independent.

The matrix of \mathbf{g} in an orthonormal basis is the diagonal matrix of η_{ij} . The elements of the inverse of this matrix (which is equal to the matrix itself) are denoted by η^{ij} . The seemingly unnecessary use of superscripts for the

inverse is not only consistent with the discussion leading to Eq. (26.31), but also with index manipulations of tensors. For example, when superscripts are used for the inverse, we have $\eta_{ij}\eta^{jk} = \delta_i^k$, with indices properly located.

Let $\{\mathbf{e}_i\}_{i=1}^N$ be an orthonormal basis of \mathcal{V} and $\mathbf{v} = v^i \mathbf{e}_i$ an arbitrary vector in \mathcal{V} . Now take the inner product of \mathbf{v} with \mathbf{e}_j to obtain

$$\mathbf{g}(\mathbf{v}, \mathbf{e}_j) = \mathbf{g}(v^i \mathbf{e}_i, \mathbf{e}_j) = v^i \eta_{ij}.$$

Multiply both sides by η^{jk} (with sum over repeated indices understood):

$$\eta^{jk} \mathbf{g}(\mathbf{v}, \mathbf{e}_j) = v^i \eta_{ij} \eta^{jk} = v^i \delta_i^k = v^k.$$

This leads to the *orthogonal expansion* of an arbitrary vector \mathbf{v} :

$$\mathbf{v} = \eta^{jk} \mathbf{g}(\mathbf{v}, \mathbf{e}_j) \mathbf{e}_k = \sum_{k=1}^N \eta^{kk} \mathbf{g}(\mathbf{v}, \mathbf{e}_k) \mathbf{e}_k = \sum_{k=1}^N \eta_{kk} \mathbf{g}(\mathbf{v}, \mathbf{e}_k) \mathbf{e}_k. \quad (26.38)$$

If \mathcal{W} is a nondegenerate subspace of an inner product space \mathcal{V} , and if we enlarge an orthonormal basis $\{\mathbf{e}_i\}_{i=1}^m$ of \mathcal{W} to an orthonormal basis of \mathcal{V} , then the operator \mathbf{P}_W projecting onto \mathcal{W} is defined as

$$\mathbf{P}_W(\mathbf{v}) = \sum_{j,k=1}^m \eta^{jk} \mathbf{g}(\mathbf{v}, \mathbf{e}_j) \mathbf{e}_k = \sum_{k=1}^m \eta^{kk} \mathbf{g}(\mathbf{v}, \mathbf{e}_k) \mathbf{e}_k = \sum_{k=1}^m \eta_{kk} \mathbf{g}(\mathbf{v}, \mathbf{e}_k) \mathbf{e}_k. \quad (26.39)$$

Clearly, $\mathbf{P}_W(\mathbf{v}) = \mathbf{v}$ if $\mathbf{v} \in \mathcal{W}$ and $\mathbf{P}_W(\mathbf{v}) = 0$ if $\mathbf{v} \in \mathcal{W}^\perp$.

Theorem 26.5.21 *The number n_- of negative signs in $(\eta_{11}, \eta_{22}, \dots, \eta_{NN})$, the signature of any orthonormal basis $\{\mathbf{e}_i\}_{i=1}^N$ of an inner product space \mathcal{V} , is equal to ν , the index of \mathcal{V} .*

Sylvester's theorem

Proof Assume that the first n_- signs are negative. If $n_- = 0$ or $n_- = N$, the proof is trivial. Let \mathcal{U} be the span of $\{\mathbf{e}_i\}_{i=1}^{n_-}$. It is obvious that $\mathbf{g}|_{\mathcal{U}}$ is negative definite. By Definition 26.5.8, $\nu \geq n_-$.

Now let \mathcal{W} be an arbitrary subspace of \mathcal{V} on which \mathbf{g} is negative definite, and define the linear map $\pi : \mathcal{W} \rightarrow \mathcal{U}$ by

$$\pi(\mathbf{w}) = \sum_{k=1}^{n_-} \eta_{kk} \mathbf{g}(\mathbf{w}, \mathbf{e}_k) \mathbf{e}_k = - \sum_{k=1}^{n_-} \mathbf{g}(\mathbf{w}, \mathbf{e}_k) \mathbf{e}_k.$$

We claim that π is injective. To prove our claim, we show $\ker \pi = 0$. If $\pi(\mathbf{w}) = 0$, then by Eq. (26.38), $\mathbf{w} = \sum_{k=n_-+1}^N \mathbf{g}(\mathbf{w}, \mathbf{e}_k) \mathbf{e}_k$, and

$$\begin{aligned} \mathbf{g}(\mathbf{w}, \mathbf{w}) &= \mathbf{g}\left(\sum_{k=n_-+1}^N \mathbf{g}(\mathbf{w}, \mathbf{e}_k) \mathbf{e}_k, \sum_{j=n_-+1}^N \mathbf{g}(\mathbf{w}, \mathbf{e}_j) \mathbf{e}_j\right) \\ &= \sum_{k=n_-+1}^N \sum_{j=n_-+1}^N \mathbf{g}(\mathbf{w}, \mathbf{e}_k) \mathbf{g}(\mathbf{w}, \mathbf{e}_j) \underbrace{\mathbf{g}(\mathbf{e}_k, \mathbf{e}_j)}_{=\eta_{kj}} \end{aligned}$$

$$= \sum_{k=n_-+1}^N [\mathbf{g}(\mathbf{w}, \mathbf{e}_k)]^2 \eta_{kk} = \sum_{k=n_-+1}^N [\mathbf{g}(\mathbf{w}, \mathbf{e}_k)]^2.$$

The left-hand side is negative (unless $\mathbf{w} = 0$ in which case it is zero), the right-hand side is positive (or zero). The only way that the equality can hold is for \mathbf{w} to be the zero vector. Hence, $\ker \pi = 0$, and π is injective. This implies that $\dim \mathcal{W} \leq n_-$. In particular, if \mathcal{W} has maximal dimension ν , we have $\nu \leq n_-$. This, along with the conclusion of the first paragraph of the proof, yields $\nu = n_-$. \square

Corollary 26.5.22 *Let \mathcal{W}^- denote the largest subspace of the inner product space \mathcal{V} on which \mathbf{g} is negative definite. Then $\mathcal{V} = \mathcal{W}^- \oplus \mathcal{W}^+$, where \mathcal{W}^+ is the orthogonal complement of \mathcal{W}^- and \mathbf{g} is positive definite on \mathcal{W}^+ .*

Take the Euclidean n -space \mathbb{R}^n and for some integer $0 \leq \nu \leq n$, change the signs of the first ν terms in the usual inner product of \mathbb{R}^n :

$$\langle \mathbf{u}, \mathbf{v} \rangle \equiv \mathbf{g}(\mathbf{u}, \mathbf{v}) = \eta_{ij} u^i v^j = \sum_{i=1}^{\nu} \eta_{ii} u^i v^i = - \sum_{i=1}^{\nu} u^i v^i + \sum_{i=\nu+1}^n u^i v^i. \tag{26.40}$$

The resulting inner product space, denoted by \mathbb{R}_ν^n , is called the **semi-Euclidean** and **Euclidean space**. For $n \geq 2$, \mathbb{R}_1^n is called the **Minkowski n -space**. \mathbb{R}_1^4 is the space of the special theory of relativity. Semi-Euclidean and Minkowski spaces

Proposition 26.5.23 *Let \mathbb{R}_ν^n and \mathbb{R}_μ^m be semi-Euclidean spaces. Then*

$$\mathbb{R}_\nu^n \oplus \mathbb{R}_\mu^m \cong \mathbb{R}_{\nu+\mu}^{n+m}.$$

Proof Apply Eq. (2.12). \square

For \mathbb{R}_ν^n , substitute the vectors of an orthonormal basis $\{\mathbf{e}_i\}_{i=1}^N$ for both \mathbf{v}_i and \mathbf{u}_j in Eq. (26.32) to get

$$\Delta_0(\mathbf{e}_1, \dots, \mathbf{e}_N)^2 = \alpha \det(\mathbf{g}(\mathbf{e}_i, \mathbf{e}_j)) = \alpha \det(\eta_{ij}) = \alpha (-1)^\nu.$$

This shows that $\alpha (-1)^\nu > 0$. Hence, we can define a new determinant function by

$$\Delta = \pm \frac{\Delta_0}{\sqrt{\alpha (-1)^\nu}}, \tag{26.41}$$

for which (26.32) takes the form

$$\Delta(\mathbf{v}_1, \dots, \mathbf{v}_N) \Delta(\mathbf{u}_1, \dots, \mathbf{u}_N) = (-1)^\nu \det(\mathbf{g}(\mathbf{v}_i, \mathbf{u}_j)). \tag{26.42}$$

A determinant function satisfying this equation is called a **normed determinant function**. Equation (26.41) shows that there are exactly two normed determinant functions Δ and $-\Delta$ in \mathcal{V} . normed determinant function

Orthonormal bases give the same oriented volume element.

Orthonormal bases allow us to speak of *the* oriented volume element. Suppose $\{\epsilon^j\}_{j=1}^N$ is an oriented orthonormal basis of \mathcal{V}^* . If $\{\varphi^k\}_{k=1}^N$ is another orthonormal basis in the same orientation and related to $\{\epsilon^j\}$ by a matrix R , then

$$\varphi^1 \wedge \varphi^2 \wedge \dots \wedge \varphi^N = (\det R)\epsilon^1 \wedge \epsilon^2 \wedge \dots \wedge \epsilon^N.$$

Since $\{\varphi^k\}$ and $\{\epsilon^j\}$ are orthonormal, the determinant of \mathbf{g} , which is $\det(\eta_{ij})$, is $(-1)^v$ in both of them. Problem 26.26 then implies that $(\det R)^2 = 1$ or $\det R = \pm 1$. However, $\{\varphi^k\}$ and $\{\epsilon^j\}$ belong to the same orientation. Thus, $\det R = +1$, and $\{\varphi^k\}$ and $\{\epsilon^j\}$ give *the same* volume element.

volume element relative to \mathbf{g}

Definition 26.5.24 The volume element of an inner product space $(\mathcal{V}, \mathbf{g})$ relative to \mathbf{g} is a volume element obtained from any orthonormal basis of \mathcal{V}^* .

We should emphasize that the invariance of v is true for *g-orthonormal bases*. As a counterexample, consider \mathbf{g} of Example 26.5.20 applied to the standard basis of \mathbb{R}^3 , which we designate with a prime. It is readily verified that

$$\mathbf{g}(\mathbf{e}'_i, \mathbf{e}'_i) = 0 \quad \text{for } i = 1, 2, 3.$$

So it might appear that $v = 0$ for this basis. However, the standard basis is *not* *g*-orthonormal. In fact,

$$\mathbf{g}(\mathbf{e}'_1, \mathbf{e}'_2) = \frac{1}{2} = \mathbf{g}(\mathbf{e}'_1, \mathbf{e}'_3) = \mathbf{g}(\mathbf{e}'_2, \mathbf{e}'_3).$$

That is why the nonstandard vectors \mathbf{e}_1, \mathbf{v} , and \mathbf{w} were chosen in Example 26.5.20.

permutation tensor

Example 26.5.25 Let $\{\mathbf{e}_i\}_{i=1}^N$ be a basis of \mathcal{V} and $\{\epsilon^i\}_{i=1}^N$ its dual. We can define the **permutation tensor**:

$$\delta_{j_1 j_2 \dots j_N}^{i_1 i_2 \dots i_N} = \epsilon^{i_1} \wedge \epsilon^{i_2} \wedge \dots \wedge \epsilon^{i_N}(\mathbf{e}_{j_1}, \mathbf{e}_{j_2}, \dots, \mathbf{e}_{j_N}). \tag{26.43}$$

It is clear from this definition that $\delta_{j_1 j_2 \dots j_N}^{i_1 i_2 \dots i_N}$ is completely skew-symmetric in all upper indices. That it is also skew-symmetric in the lower indices can be seen as follows. Assume that two of the lower indices are equal. This means having two \mathbf{e}_j 's equal in (26.43). These two \mathbf{e}_j 's will contract with two ϵ^l 's, say ϵ^k and ϵ^l . Thus, in the expansion there will be a term $C\epsilon^k(\mathbf{e}_j)\epsilon^l(\mathbf{e}_j)$, where C is the product of all the other factors. Since the product is completely skew-symmetric in the upper indices, there must also exist another term, with a minus sign and in which the upper indices k and l are interchanged: $-C\epsilon^l(\mathbf{e}_j)\epsilon^k(\mathbf{e}_j)$. This makes the sum zero, and by Theorem 2.6.3, (26.43) is antisymmetric in the lower indices as well.

This suggests that $\delta_{j_1 j_2 \dots j_N}^{i_1 i_2 \dots i_N} \propto \epsilon^{i_1 i_2 \dots i_N} \epsilon_{j_1 j_2 \dots j_N}$. To find the proportional-ity constant, we note that (see Problem 26.14)

$$\delta_{12 \dots N}^{12 \dots N} = \sum_{\pi} \epsilon_{\pi(1)\pi(2)\dots\pi(N)} \delta_{\pi(1)}^1 \delta_{\pi(2)}^2 \dots \delta_{\pi(N)}^N.$$

The only contribution to the sum comes from the permutation with the property $\pi(i) = i$. This is the identity permutation for which $\epsilon_\pi = 1$. Thus, we have $\delta_{12\dots N}^{12\dots N} = 1$. On the other hand, by Problem 26.25,

$$\epsilon^{12\dots N} \epsilon_{12\dots N} = \epsilon^{12\dots N} = (-1)^{n-}.$$

Therefore, the proportionality constant is $(-1)^{n-}$. Thus

$$\epsilon^{i_1 i_2 \dots i_N} \epsilon_{j_1 j_2 \dots j_N} = (-1)^{n-} \delta_{j_1 j_2 \dots j_N}^{i_1 i_2 \dots i_N}. \tag{26.44}$$

We can find an explicit expression for the permutation tensor of Example 26.5.25. Expanding the RHS of Eq. (26.43) using Eq. (26.18), we obtain

$$\begin{aligned} \delta_{j_1 j_2 \dots j_N}^{i_1 i_2 \dots i_N} &= \sum_{\pi} \epsilon_{\pi} \delta_{\pi(j_1)}^{i_1} \delta_{\pi(j_2)}^{i_2} \cdots \delta_{\pi(j_N)}^{i_N}, \\ \epsilon^{i_1 i_2 \dots i_N} \epsilon_{j_1 j_2 \dots j_N} &= (-1)^{n-} \sum_{\pi} \epsilon_{\pi} \delta_{\pi(j_1)}^{i_1} \delta_{\pi(j_2)}^{i_2} \cdots \delta_{\pi(j_N)}^{i_N}. \end{aligned} \tag{26.45}$$

Furthermore, the first equation of (26.45) can be written concisely as a determinant, because

$$\delta_{12\dots N}^{i_1 i_2 \dots i_N} = \sum_{\pi} \epsilon_{\pi(1)\pi(2)\dots\pi(N)} \delta_{\pi(1)}^{i_1} \delta_{\pi(2)}^{i_2} \cdots \delta_{\pi(N)}^{i_N}.$$

The RHS is clearly the determinant of a matrix (expanded with respect to the i th row) whose elements are δ_k^i . The same holds true if $1, 2, \dots, N$ is replaced by j_1, j_2, \dots, j_N ; thus,

$$\delta_{j_1 j_2 \dots j_N}^{i_1 i_2 \dots i_N} = \det \begin{pmatrix} \delta_{j_1}^{i_1} & \delta_{j_2}^{i_1} & \cdots & \delta_{j_N}^{i_1} \\ \delta_{j_1}^{i_2} & \delta_{j_2}^{i_2} & \cdots & \delta_{j_N}^{i_2} \\ \vdots & \vdots & \ddots & \vdots \\ \delta_{j_1}^{i_N} & \delta_{j_2}^{i_N} & \cdots & \delta_{j_N}^{i_N} \end{pmatrix}. \tag{26.46}$$

Example 26.5.26 Let us apply the second equation of (26.45) to Euclidean \mathbb{R}^3 :

$$\epsilon^{ijk} \epsilon_{lmn} = \delta_l^i \delta_m^j \delta_n^k - \delta_l^i \delta_n^j \delta_m^k - \delta_m^i \delta_l^j \delta_n^k + \delta_m^i \delta_n^j \delta_l^k + \delta_n^i \delta_l^j \delta_m^k - \delta_n^i \delta_m^j \delta_l^k.$$

From this fundamental relation, we can obtain other useful formulas. For example, setting $n = k$ and summing over k , we get

$$\epsilon^{ijk} \epsilon_{lmk} = 3\delta_l^i \delta_m^j - \delta_l^i \delta_m^j - 3\delta_m^i \delta_l^j + \delta_m^i \delta_l^j + \delta_m^i \delta_l^j - \delta_l^i \delta_m^j = \delta_l^i \delta_m^j - \delta_m^i \delta_l^j.$$

Now set $m = j$ in this equation and sum over j :

$$\epsilon^{ijk} \epsilon_{ijk} = 3\delta_l^i - \delta_l^i = 2\delta_l^i.$$

Finally, let $l = i$ and sum over i :

$$\epsilon^{ijk} \epsilon_{ijk} = 2\delta_i^i = 2 \cdot 3 = 3!.$$

In general,

$$\begin{aligned}\delta_{i_1 i_2 \dots i_N}^{i_1 i_2 \dots i_N} &= N!, \quad \text{or} \quad \epsilon^{i_1 i_2 \dots i_N} \epsilon_{i_1 i_2 \dots i_N} = (-1)^n N!, \\ \delta_{i_1 i_2 \dots i_{N-1} j_N}^{i_1 i_2 \dots i_{N-1} i_N} &= (N-1)! \delta_{j_N}^{i_N}, \quad \text{or} \\ \epsilon^{i_1 i_2 \dots i_{N-1} i_N} \epsilon_{i_1 i_2 \dots i_{N-1} j_N} &= (-1)^{n-1} (N-1)! \delta_{j_N}^{i_N},\end{aligned}$$

and

$$\begin{aligned}\delta_{i_1 i_2 \dots i_{N-2} j_{N-1} j_N}^{i_1 i_2 \dots i_{N-2} i_{N-1} i_N} &= (N-2)! (\delta_{j_{N-1}}^{i_{N-1}} \delta_{j_N}^{i_N} - \delta_{j_N}^{i_{N-1}} \delta_{j_{N-1}}^{i_N}) \\ &= (N-2)! \delta_{j_{N-1} j_N}^{i_{N-1} i_N}, \quad \text{or} \\ \epsilon^{i_1 i_2 \dots i_{N-2} i_{N-1} i_N} \epsilon_{i_1 i_2 \dots i_{N-2} j_{N-1} j_N} &= (-1)^{n-2} (N-2)! (\delta_{j_{N-1}}^{i_{N-1}} \delta_{j_N}^{i_N} - \delta_{j_N}^{i_{N-1}} \delta_{j_{N-1}}^{i_N}).\end{aligned}$$

More generally,

$$\delta_{i_1 i_2 \dots i_p j_{p+1} \dots j_N}^{i_1 i_2 \dots i_p i_{p+1} \dots i_N} = p! \delta_{j_{p+1} \dots j_N}^{i_{p+1} \dots i_N}. \quad (26.47)$$

Equation (26.47) can be generalized even further:

$$\delta_{i_{k+1} \dots i_{k+p} j_{k+p+1} \dots j_N}^{i_{k+1} \dots i_{k+p} i_{k+p+1} \dots i_N} = \frac{(p+k)!}{k!} \delta_{j_{k+p+1} \dots j_N}^{i_{k+p+1} \dots i_N}. \quad (26.48)$$

If you set the j 's equal to i 's in Eq. (26.47), you get $N!$ on the left-hand side. Equation (26.48) then yields $N!/p!$ on the right-hand side, making the two sides equal.

Another useful property of the permutation tensor is (Problem 26.15)

$$\delta_{j_1 j_2 \dots j_r}^{i_1 i_2 \dots i_r} A_{i_1 i_2 \dots i_r} = \sum_{\pi} \epsilon_{\pi} A_{\pi(j_1) \pi(j_2) \dots \pi(j_r)} \quad (26.49)$$

for any tensor (the tensor could have more indices, and some of the r indices could be mixed). In particular if \mathbf{A} is antisymmetric in $i_1 i_2 \dots i_r$, then

$$\delta_{j_1 j_2 \dots j_r}^{i_1 i_2 \dots i_r} A_{i_1 i_2 \dots i_r} = r! A_{j_1 j_2 \dots j_r}. \quad (26.50)$$

Example 26.5.27 As an application of the foregoing formalism, we can express the determinant of a 2×2 matrix in terms of traces. Let \mathbf{A} be such a matrix with elements A_j^i . Then

$$\begin{aligned}\det \mathbf{A} &= \epsilon_{ij} A_1^i A_2^j = \frac{1}{2} (\epsilon_{ij} A_1^i A_2^j - \epsilon_{ij} A_2^i A_1^j) = \frac{1}{2} (\epsilon_{ij} \epsilon^{kl} A_k^i A_l^j) \\ &= \frac{1}{2} A_k^i A_l^j (\delta_i^k \delta_j^l - \delta_j^k \delta_i^l) = \frac{1}{2} (A_i^i A_j^j - A_j^i A_i^j) \\ &= \frac{1}{2} [(\text{tr } \mathbf{A})(\text{tr } \mathbf{A}) - (\mathbf{A}^2)_i^i] = \frac{1}{2} [(\text{tr } \mathbf{A})^2 - \text{tr}(\mathbf{A}^2)].\end{aligned}$$

We can generalize the result of the example above and express the determinant of an $N \times N$ matrix as

$$\begin{aligned} \det \mathbf{A} &= \frac{1}{N!} \epsilon^{i_1 i_2 \dots i_N} \epsilon_{j_1 j_2 \dots j_N} A_{i_1}^{j_1} A_{i_2}^{j_2} \dots A_{i_N}^{j_N} \\ &= \frac{1}{N!} \sum_{\pi} \epsilon_{\pi} \delta_{\pi(j_1)}^{i_1} \delta_{\pi(j_2)}^{i_2} \dots \delta_{\pi(j_N)}^{i_N} A_{i_1}^{j_1} A_{i_2}^{j_2} \dots A_{i_N}^{j_N}. \end{aligned} \quad (26.51)$$

26.5.3 Inner Product on $\Lambda^p(\mathcal{V}, \mathcal{U})$

If $(\mathcal{V}, \mathbf{g})$ is an inner product space, then \mathbf{g} induces an inner product $\tilde{\mathbf{g}}$ on $\Lambda^p(\mathcal{V})$ as follows. Extend the mapping $\mathbf{g}_*^{-1} : \mathcal{V}^* \rightarrow \mathcal{V}$ to the space of p -forms by applying it to each factor (e.g., in the expansion of the p -form in a basis of $\Lambda^p(\mathcal{V})$). This extension makes \mathbf{g}_*^{-1} a map $\mathbf{g}_*^{-1} : \Lambda^p(\mathcal{V}) \rightarrow \Lambda^p(\mathcal{V}^*)$ which takes a p -form $\boldsymbol{\beta}$ and turns it into a p -vector $\mathbf{g}_*^{-1}(\boldsymbol{\beta})$. Then the pairing $\langle \boldsymbol{\alpha}, \mathbf{g}_*^{-1}(\boldsymbol{\beta}) \rangle$, with $\boldsymbol{\alpha}, \boldsymbol{\beta} \in \Lambda^p(\mathcal{V})$, is the desired induced inner product. More specifically, let $\{\mathbf{e}_j\}_{j=1}^N$ be a basis of \mathcal{V} and $\{\boldsymbol{\epsilon}^i\}_{i=1}^N$ its dual basis. Then,

$$\begin{aligned} \mathbf{g}_*^{-1}(\boldsymbol{\beta}) &\equiv \mathbf{g}_*^{-1} \left(\frac{1}{p!} \beta_{i_1 i_2 \dots i_p} \boldsymbol{\epsilon}^{i_1} \wedge \boldsymbol{\epsilon}^{i_2} \wedge \dots \wedge \boldsymbol{\epsilon}^{i_p} \right) \\ &= \frac{1}{p!} \beta_{i_1 i_2 \dots i_p} (\mathbf{g}_*^{-1}(\boldsymbol{\epsilon}^{i_1}) \wedge \mathbf{g}_*^{-1}(\boldsymbol{\epsilon}^{i_2}) \wedge \dots \wedge \mathbf{g}_*^{-1}(\boldsymbol{\epsilon}^{i_p})) \\ &= \frac{1}{p!} \beta_{i_1 i_2 \dots i_p} (g^{i_1 j_1} \mathbf{e}_{j_1} \wedge g^{i_2 j_2} \mathbf{e}_{j_2} \wedge \dots \wedge g^{i_p j_p} \mathbf{e}_{j_p}) \\ &= \frac{1}{p!} g^{i_1 j_1} g^{i_2 j_2} \dots g^{i_p j_p} \beta_{i_1 i_2 \dots i_p} \mathbf{e}_{j_1} \wedge \mathbf{e}_{j_2} \wedge \dots \wedge \mathbf{e}_{j_p} \\ &\equiv \frac{1}{p!} \beta^{j_1 j_2 \dots j_p} \mathbf{e}_{j_1} \wedge \mathbf{e}_{j_2} \wedge \dots \wedge \mathbf{e}_{j_p}. \end{aligned}$$

Note how the indices of the components of $\boldsymbol{\beta}$ have been raised by the components of the \mathbf{g}^{-1} . Pairing this last expression with $\boldsymbol{\alpha}$, we get

$$\begin{aligned} \tilde{\mathbf{g}}(\boldsymbol{\alpha}, \boldsymbol{\beta}) &= \langle \boldsymbol{\alpha}, \mathbf{g}_*^{-1}(\boldsymbol{\beta}) \rangle \\ &= \frac{1}{(p!)^2} \alpha_{i_1 i_2 \dots i_p} \beta^{j_1 j_2 \dots j_p} \langle \boldsymbol{\epsilon}^{i_1} \wedge \dots \wedge \boldsymbol{\epsilon}^{i_p}, \mathbf{e}_{j_1} \wedge \dots \wedge \mathbf{e}_{j_p} \rangle \\ &\equiv \frac{1}{(p!)^2} \alpha_{i_1 i_2 \dots i_p} \beta^{j_1 j_2 \dots j_p} \boldsymbol{\epsilon}^{i_1} \wedge \boldsymbol{\epsilon}^{i_2} \wedge \dots \wedge \boldsymbol{\epsilon}^{i_p} (\mathbf{e}_{j_1}, \mathbf{e}_{j_2}, \dots, \mathbf{e}_{j_p}) \\ &= \frac{1}{(p!)^2} \sum_{\pi} \epsilon_{\pi} \delta_{\pi(j_1)}^{i_1} \delta_{\pi(j_2)}^{i_2} \dots \delta_{\pi(j_p)}^{i_p} \alpha_{i_1 i_2 \dots i_p} \beta^{j_1 j_2 \dots j_p}, \end{aligned}$$

where in the last step we used Eq. (26.18). Therefore,

$$\tilde{\mathbf{g}}(\boldsymbol{\alpha}, \boldsymbol{\beta}) = \frac{1}{(p!)^2} \sum_{\pi} \epsilon_{\pi} \alpha_{\pi(j_1) \pi(j_2) \dots \pi(j_p)} \beta^{j_1 j_2 \dots j_p} = \frac{1}{p!} \alpha_{j_1 j_2 \dots j_p} \beta^{j_1 j_2 \dots j_p}, \quad (26.52)$$

because $\alpha_{\pi(j_1)\pi(j_2)\dots\pi(j_p)} = \epsilon_{\pi} \alpha_{j_1 j_2 \dots j_p}$ due to the antisymmetry of the components of p -forms.

Having found $\tilde{\mathbf{g}}$, we can extend it further to $\Lambda^p(\mathcal{V}, \mathcal{U})$ if \mathcal{U} has an inner product \mathbf{h} . Let $\{\mathbf{f}_a\}_{a=1}^{\dim \mathcal{U}}$ be a basis of \mathcal{U} , and note that any $\boldsymbol{\alpha} \in \Lambda^p(\mathcal{V}, \mathcal{U})$ can be written as $\boldsymbol{\alpha} = \sum_{a=1}^{\dim \mathcal{U}} \alpha^a \mathbf{f}_a$, where $\alpha^a \in \Lambda^p(\mathcal{V})$. Denote the inner product of $\Lambda^p(\mathcal{V}, \mathcal{U})$ as \mathbf{gh} and, for

$$\boldsymbol{\alpha} = \sum_{a=1}^{\dim \mathcal{U}} \alpha^a \mathbf{f}_a, \quad \boldsymbol{\beta} = \sum_{b=1}^{\dim \mathcal{U}} \beta^b \mathbf{f}_b,$$

define it as

$$\tilde{\mathbf{gh}}(\boldsymbol{\alpha}, \boldsymbol{\beta}) = \sum_{a,b=1}^{\dim \mathcal{U}} \tilde{\mathbf{g}}(\alpha^a, \beta^b) \mathbf{h}(\mathbf{f}_a, \mathbf{f}_b) \equiv \sum_{a,b=1}^{\dim \mathcal{U}} h_{ab} \tilde{\mathbf{g}}(\alpha^a, \beta^b). \quad (26.53)$$

It is routine to show that $\tilde{\mathbf{gh}}$ is basis-independent.

26.6 The Hodge Star Operator

It was established in Chap. 4 that all vector spaces of the same dimension are isomorphic. Therefore, the two vector spaces $\Lambda^p(\mathcal{V})$ and $\Lambda^{N-p}(\mathcal{V})$ having the same dimension, $\binom{N}{p} = \binom{N}{N-p}$, must be isomorphic. In fact, there is a *natural* isomorphism between the two spaces:

Hodge star operator

Definition 26.6.1 Let \mathbf{g} be an inner product and $\{\boldsymbol{\epsilon}^i\}_{i=1}^N$ a g -orthonormal ordered basis of \mathcal{V}^* . The **Hodge star operator** is a linear mapping, $*$: $\Lambda^p(\mathcal{V}) \rightarrow \Lambda^{N-p}(\mathcal{V})$, given by (remember Einstein's summation convention!)

$$*(\boldsymbol{\epsilon}^{i_1} \wedge \dots \wedge \boldsymbol{\epsilon}^{i_p}) \equiv \frac{1}{(N-p)!} \epsilon^{i_1 i_2 \dots i_p j_{p+1} \dots j_N} \boldsymbol{\epsilon}^{j_{p+1}} \wedge \dots \wedge \boldsymbol{\epsilon}^{j_N}. \quad (26.54)$$

A similar star operator can be defined on p -vectors. $\epsilon^{i_1 i_2 \dots i_p j_{p+1} \dots j_N}$ is obtained from $\epsilon_{j_1 \dots j_N}$ by raising its first p subscripts.

Although this definition is based on a choice of basis, it can be shown that the operator is basis-independent. In fact, if $\boldsymbol{\omega} = \frac{1}{p!} \omega_{i_1 \dots i_p} \boldsymbol{\epsilon}^{i_1} \wedge \dots \wedge \boldsymbol{\epsilon}^{i_p}$, then Eq. (26.54) gives

$$*\boldsymbol{\omega} = \frac{1}{p!(N-p)!} \omega^{j_1 \dots j_p} \epsilon_{j_1 j_2 \dots j_N} \boldsymbol{\epsilon}^{j_{p+1}} \wedge \dots \wedge \boldsymbol{\epsilon}^{j_N}. \quad (26.55)$$

Now let $\{\mathbf{v}_j\}_{j=1}^N$ be any other basis of \mathcal{V} positively oriented relative to $\{\boldsymbol{\epsilon}^i\}_{i=1}^N$. Let $\{\boldsymbol{\theta}^j\}_{j=1}^N$ be dual to $\{\mathbf{v}_j\}_{j=1}^N$. Write $\mathbf{v}_i = R_i^j \mathbf{e}_j$ and (therefore) $\boldsymbol{\theta}^i = (R^{-1})^i_j \boldsymbol{\epsilon}^j$. Furthermore, denoting $\mathbf{g}^{-1}(\boldsymbol{\omega})$ by $\tilde{\boldsymbol{\omega}}$, we have

$$\omega^{j_1 \dots j_p} \equiv \tilde{\boldsymbol{\omega}}(\boldsymbol{\epsilon}^{j_1}, \dots, \boldsymbol{\epsilon}^{j_p}) = \tilde{\boldsymbol{\omega}}(R_{i_1}^{j_1} \boldsymbol{\theta}^{i_1}, \dots, R_{i_p}^{j_p} \boldsymbol{\theta}^{i_p}) = R_{i_1}^{j_1} \dots R_{i_p}^{j_p} \tilde{\omega}^{i_1 \dots i_p},$$

where $\tilde{\omega}^{i_1 \dots i_p}$ are the components of $\boldsymbol{\omega}$ in the general basis $\{\mathbf{v}_j\}_{j=1}^N$. Substituting the last expression above and $\boldsymbol{\epsilon}^j$'s in terms of $\boldsymbol{\theta}^i$'s in Eq. (26.55), we get

$$\begin{aligned} * \boldsymbol{\omega} &= \frac{1}{p!(N-p)!} R_{i_1}^{j_1} \dots R_{i_p}^{j_p} \tilde{\omega}^{i_1 \dots i_p} \epsilon_{j_1 j_2 \dots j_N} (R_{i_{p+1}}^{j_{p+1}} \boldsymbol{\theta}^{i_{p+1}}) \wedge \dots \wedge (R_{i_N}^{j_N} \boldsymbol{\theta}^{i_N}) \\ &= \frac{1}{p!(N-p)!} \tilde{\omega}^{i_1 \dots i_p} \underbrace{(\epsilon_{j_1 j_2 \dots j_N} R_{i_1}^{j_1} \dots R_{i_N}^{j_N})}_{= \epsilon_{i_1 i_2 \dots i_N} \det R} \boldsymbol{\theta}^{i_{p+1}} \wedge \dots \wedge \boldsymbol{\theta}^{i_N}. \end{aligned}$$

Using the result $\det R = |\det G|^{1/2} \equiv |G|^{1/2}$ (Problem 26.26), where G denotes the matrix of \mathbf{g} in $\{\mathbf{v}_j\}_{j=1}^N$, we finally obtain

$$\begin{aligned} * \boldsymbol{\omega} &= |G|^{1/2} \frac{1}{p!(N-p)!} \tilde{\omega}^{i_1 \dots i_p} \epsilon_{i_1 i_2 \dots i_N} \boldsymbol{\theta}^{i_{p+1}} \wedge \dots \wedge \boldsymbol{\theta}^{i_N} \\ &= |G|^{1/2} \frac{1}{p!} \tilde{\omega}^{i_1 \dots i_p} \epsilon_{i_1 i_2 \dots i_N} \boldsymbol{\theta}^{i_{p+1}} \otimes \dots \otimes \boldsymbol{\theta}^{i_N}, \end{aligned} \tag{26.56}$$

where the last equality follows because $\boldsymbol{\theta}^{i_{p+1}} \otimes \dots \otimes \boldsymbol{\theta}^{i_N}$ does not have a symmetry. Note that this last expression reduces to (26.55), because $|G| = 1$ in an orthonormal basis, and $*\boldsymbol{\omega}$ as given by Eq. (26.56) is indeed basis-independent.

Example 26.6.2 Let us apply Definition 26.6.1 to $\Lambda^p(\mathbb{R}^{3*})$ for $p = 0, 1, 2, 3$. Let $\{\mathbf{e}_1, \mathbf{e}_2, \mathbf{e}_3\}$ be an oriented orthonormal basis of \mathbb{R}^3 .

(a) For $\Lambda^0(\mathbb{R}^{3*}) = \mathbb{R}$ a basis is 1, and (26.54) gives

$$*1 = \frac{1}{3!} \epsilon^{ijk} \mathbf{e}_i \wedge \mathbf{e}_j \wedge \mathbf{e}_k = \mathbf{e}_1 \wedge \mathbf{e}_2 \wedge \mathbf{e}_3.$$

(b) For $\Lambda^1(\mathbb{R}^{3*}) = \mathbb{R}^3$ a basis is $\{\mathbf{e}_1, \mathbf{e}_2, \mathbf{e}_3\}$, and (26.54) gives $*\mathbf{e}_i = \frac{1}{2!} \epsilon_i^{jk} \mathbf{e}_j \wedge \mathbf{e}_k$, or $*\mathbf{e}_1 = \mathbf{e}_2 \wedge \mathbf{e}_3$, $*\mathbf{e}_2 = \mathbf{e}_3 \wedge \mathbf{e}_1$, $*\mathbf{e}_3 = \mathbf{e}_1 \wedge \mathbf{e}_2$.

(c) For $\Lambda^2(\mathbb{R}^{3*})$ a basis is $\{\mathbf{e}_1 \wedge \mathbf{e}_2, \mathbf{e}_1 \wedge \mathbf{e}_3, \mathbf{e}_2 \wedge \mathbf{e}_3\}$, and (26.54) gives $*\mathbf{e}_i \wedge \mathbf{e}_j = \epsilon_{ij}^k \mathbf{e}_k$, or $*(\mathbf{e}_1 \wedge \mathbf{e}_2) = \mathbf{e}_3$, $*(\mathbf{e}_1 \wedge \mathbf{e}_3) = -\mathbf{e}_2$, $*(\mathbf{e}_2 \wedge \mathbf{e}_3) = \mathbf{e}_1$.

(d) For $\Lambda^3(\mathbb{R}^{3*})$ a basis is $\{\mathbf{e}_1 \wedge \mathbf{e}_2 \wedge \mathbf{e}_3\}$, and (26.54) yields $*(\mathbf{e}_1 \wedge \mathbf{e}_2 \wedge \mathbf{e}_3) = \epsilon_{123} = 1$.

The preceding example may suggest that applying the Hodge star operator twice (composition of $*$ with itself, or $* \circ *$) is equivalent to applying the identity operator. This is partially true. The following theorem is a precise statement of this conjecture. (For a proof, see [Bish 80, p. 111].)

Theorem 26.6.3 Let \mathcal{V} be an oriented space with an inner product \mathbf{g} . For $\mathbf{A} \in \Lambda^p(\mathcal{V})$, we have

$$* \circ * \mathbf{A} \equiv ** \mathbf{A} = (-1)^v (-1)^{p(N-p)} \mathbf{A}, \quad (26.57)$$

where v is the index of \mathbf{g} and $N = \dim \mathcal{V}$.

In particular, for Euclidean spaces with an odd number of dimensions (such as \mathbb{R}^3), $** \mathbf{A} = \mathbf{A}$.

One can extend the star operation to any $\mathbf{A} \in \Lambda^p(\mathcal{V})$ by writing \mathbf{A} as a linear combination of basis vectors of $\Lambda^p(\mathcal{V})$ constructed out of $\{\mathbf{e}_i\}_{i=1}^N$, and using the linearity of $*$.

The star operator creates an $(N - p)$ -form out of a p -form. If we take the exterior product of a p -form and the star of another p -form, we get an N -form, which is proportional to a volume element. In fact, one can prove (Problem 26.33)

Theorem 26.6.4 Let $(\mathcal{V}, \mathbf{g})$ be an inner product space and $\boldsymbol{\mu}$ a volume element relative to \mathbf{g} . Let $\tilde{\mathbf{g}}$ be the inner product induced by \mathbf{g} on $\Lambda^p(\mathcal{V})$ and given explicitly in Eq. (26.52). Then for $\boldsymbol{\alpha}, \boldsymbol{\beta} \in \Lambda^p(\mathcal{V})$, we have $\boldsymbol{\alpha} \wedge * \boldsymbol{\beta} = \tilde{\mathbf{g}}(\boldsymbol{\alpha}, \boldsymbol{\beta}) \boldsymbol{\mu}$.

antisymmetric tensors
with numerical
coefficients

In the discussion of exterior algebra one encounters sums of the form

$$A^{i_1 \dots i_p} \mathbf{v}_{i_1} \wedge \dots \wedge \mathbf{v}_{i_p}.$$

It is important to note that $A^{i_1 \dots i_p}$ is assumed skew-symmetric. For example, if $\mathbf{A} = \mathbf{e}_1 \wedge \mathbf{e}_2$, then in the sum $\mathbf{A} = A^{ij} \mathbf{e}_i \wedge \mathbf{e}_j$, the nonzero components consist of $A^{12} = \frac{1}{2}$ and $A^{21} = -\frac{1}{2}$. Similarly, when $\mathbf{B} = \mathbf{e}_1 \wedge \mathbf{e}_2 \wedge \mathbf{e}_3$ is written in the form $\mathbf{B} = B^{ijk} \mathbf{e}_i \wedge \mathbf{e}_j \wedge \mathbf{e}_k$, it is understood that the nonzero components of \mathbf{B} are not restricted to B^{123} . Other components, such as B^{132} , B^{231} , and so on, are also nonzero. In fact, we have

$$B^{123} = -B^{132} = -B^{213} = B^{231} = B^{312} = -B^{321} = \frac{1}{6}.$$

This should be kept in mind when sums over exterior products with numerical coefficients are encountered.

Cross product is defined
only in three
dimensions!

Example 26.6.5 Let $\mathbf{a}, \mathbf{b} \in \mathbb{R}^3$ and $\{\mathbf{e}_1, \mathbf{e}_2, \mathbf{e}_3\}$ an oriented orthonormal basis of \mathbb{R}^3 . Then $\mathbf{a} = a^i \mathbf{e}_i$ and $\mathbf{b} = b^j \mathbf{e}_j$. Let us calculate $\mathbf{a} \wedge \mathbf{b}$ and $*(\mathbf{a} \wedge \mathbf{b})$. We assume a Euclidean \mathbf{g} on \mathbb{R}^3 . Then $\mathbf{a} \wedge \mathbf{b} = (a^i \mathbf{e}_i) \wedge (b^j \mathbf{e}_j) = a^i b^j \mathbf{e}_i \wedge \mathbf{e}_j$, and

$$*(\mathbf{a} \wedge \mathbf{b}) = *(a^i \mathbf{e}_i) \wedge (b^j \mathbf{e}_j) = a^i b^j *(\mathbf{e}_i \wedge \mathbf{e}_j) = a^i b^j (\epsilon_{ij}^k \mathbf{e}_k) = (\epsilon_{ij}^k a^i b^j) \mathbf{e}_k.$$

We see that $*(\mathbf{a} \wedge \mathbf{b})$ is a vector with components $[(\mathbf{a} \wedge \mathbf{b})]^k = \epsilon_{ij}^k a^i b^j$, which are precisely the components of $\mathbf{a} \times \mathbf{b}$.

The correspondence between $\mathbf{a} \wedge \mathbf{b}$ and $\mathbf{a} \times \mathbf{b}$ holds *only in three dimensions*, because $\dim \Lambda^1(\mathcal{V}) = \dim \Lambda^2(\mathcal{V})$ only if $\dim \mathcal{V} = 3$.

Example 26.6.6 We can use the results of Examples 26.5.26 and 26.6.5 to establish a sample of familiar vector identities componentwise.

(a) For the triple cross product, we have

$$\begin{aligned} [\mathbf{a} \times (\mathbf{b} \times \mathbf{c})]^k &= \epsilon_{ij}^k a^i (\mathbf{b} \times \mathbf{c})^j = \epsilon_{ij}^k a^i (\epsilon_{lm}^j b^l c^m) = a_i b^l c^m \epsilon^{kij} \epsilon_{jlm} \\ &= a_i b^l c^m \epsilon^{kij} \epsilon_{lmj} = a_i b^l c^m (\delta_l^k \delta_m^i - \delta_m^k \delta_l^i) \\ &= a_i b^k c^i - a_i b^i c^k = (\mathbf{a} \cdot \mathbf{c}) b^k - (\mathbf{a} \cdot \mathbf{b}) c^k, \end{aligned}$$

which is the k th component of $\mathbf{b}(\mathbf{a} \cdot \mathbf{c}) - \mathbf{c}(\mathbf{a} \cdot \mathbf{b})$. In deriving the above “bac cab” rule, we used the fact that one can swap an upper index with the same lower index: $a^i b_i = a_i b^i$.

(b) Next we show the familiar statement that the divergence of curl is zero. Let ∂_i denote differentiation with respect to x_i . Then

$$\begin{aligned} \nabla \cdot (\nabla \times \mathbf{a}) &= \partial_i (\nabla \times \mathbf{a})^i = \partial_i \epsilon_{jk}^i \partial^j a^k = \epsilon^{ijk} \partial_i \partial_j a_k \\ &= -\epsilon^{jik} \partial_i \partial_j a_k = -\epsilon^{jik} \partial_j \partial_i a_k = -\partial_j (\epsilon^{jik} \partial_i a_k) \\ &= -\partial_j (\nabla \times \mathbf{a})^j = -\nabla \cdot (\nabla \times \mathbf{a}) \Rightarrow \nabla \cdot (\nabla \times \mathbf{a}) = 0. \end{aligned}$$

(c) Finally, we show that curl of gradient is zero:

$$[\nabla \times (\nabla f)]^k = \epsilon_{jk}^i \partial^j \partial^k f = \epsilon^{ijk} \partial_j \partial_k f = 0,$$

because ϵ^{ijk} is antisymmetric in jk , while $\partial_j \partial_k f$ is symmetric in jk .

Example above shows in general that

Box 26.6.7 When the product of two tensors is summed over a pair of indices in which one of the tensors is symmetric and the other antisymmetric, the result is zero.

26.7 Problems

26.1 Show that the mapping $\mathbf{v} : \mathcal{V}^* \rightarrow \mathbb{R}$ given by $\mathbf{v}(\boldsymbol{\tau}) = \boldsymbol{\tau}(\mathbf{v})$ is linear.

26.2 Show that the components of a tensor product are the products of the components of the factors:

$$(\mathbf{U} \otimes \mathbf{T})_{j_1 \dots j_{s+l}}^{i_1 \dots i_{r+k}} = U_{j_1 \dots j_s}^{i_1 \dots i_r} T_{j_{s+1} \dots j_{s+l}}^{i_{r+1} \dots i_{r+k}}.$$

26.3 Show that $\mathbf{e}_{j_1} \otimes \cdots \otimes \mathbf{e}_{j_r} \otimes \boldsymbol{\epsilon}^{i_1} \otimes \cdots \otimes \boldsymbol{\epsilon}^{i_s}$ are linearly independent. Hint: Consider $A_{i_1 \dots i_s}^{j_1 \dots j_r} \mathbf{e}_{j_1} \otimes \cdots \otimes \mathbf{e}_{j_r} \otimes \boldsymbol{\epsilon}^{i_1} \otimes \cdots \otimes \boldsymbol{\epsilon}^{i_s} = 0$ and evaluate the LHS on appropriate tensors to show that all coefficients are zero.

26.4 What is the tensor product of $\mathbf{A} = 2\mathbf{e}_x - \mathbf{e}_y + 3\mathbf{e}_z$ with itself?

26.5 If $\mathbf{A} \in \mathcal{L}(\mathcal{V})$ is represented by A_j^i in the basis $\{\mathbf{e}_i\}$ and by $A_l'^k$ in $\{\mathbf{e}'_k\}$, then show that

$$A_l'^k \boldsymbol{\epsilon}'^l \otimes \boldsymbol{\epsilon}^j = A_j^i \mathbf{e}_i \otimes \boldsymbol{\epsilon}^j,$$

where $\{\boldsymbol{\epsilon}^j\}$ and $\{\boldsymbol{\epsilon}'^l\}$ are dual to $\{\mathbf{e}_i\}$ and $\{\mathbf{e}'_k\}$, respectively.

26.6 Prove that the linear functional $\mathbf{F} : \mathcal{V} \rightarrow \mathbb{R}$ is a linear invariant, i.e., basis-independent, function.

26.7 Show that $\text{tr} : \mathcal{T}_1^1 \rightarrow \mathbb{R}$ is an invariant linear function.

26.8 If \mathbf{A} is skew-symmetric in some pair of variables, show that $\mathbb{S}(\mathbf{A}) = 0$.

26.9 Using the exterior product show whether the following three vectors are linearly dependent or independent:

$$\mathbf{v}_1 = 2\mathbf{e}_1 - \mathbf{e}_2 + 3\mathbf{e}_3 - \mathbf{e}_4,$$

$$\mathbf{v}_2 = -\mathbf{e}_1 + 3\mathbf{e}_2 - 2\mathbf{e}_4,$$

$$\mathbf{v}_3 = 3\mathbf{e}_1 + 2\mathbf{e}_2 - 4\mathbf{e}_3 + \mathbf{e}_4.$$

26.10 Show that $\{\mathbf{e}_k \wedge \mathbf{e}_i\}$ with $k < i$ are linearly independent.

26.11 Let $\mathbf{v} \in \mathcal{V}$ be nonzero, and let $\mathbf{A} \in \Lambda^p(\mathcal{V}^*)$. Show that $\mathbf{v} \wedge \mathbf{A} = 0$ if and only if there exists $\mathbf{B} \in \Lambda^{p-1}(\mathcal{V}^*)$ such that $\mathbf{A} = \mathbf{v} \wedge \mathbf{B}$. Hint: Let \mathbf{v} be the first vector of a basis; separate out \mathbf{v} in the expansion of \mathbf{A} in terms of the p -fold wedge products of basis vectors, and multiply the result by \mathbf{v} .

26.12 Let $\mathbf{A} \in \Lambda^2(\mathcal{V})$ with components A^{ij} . Show that $\mathbf{A} \wedge \mathbf{A} = 0$ if and only if $A^{ij}A^{kl} - A^{ik}A^{jl} + A^{il}A^{jk} = 0$ for all i, j, k, l in any basis.

26.13 Let $\{\mathbf{e}_1, \mathbf{e}_2, \mathbf{e}_3\}$ be any basis in \mathbb{R}^3 . Define an operator $\mathbf{E} : \mathbb{R}^3 \rightarrow \mathbb{R}^3$ that permutes any set of three vectors $\{\mathbf{v}_1, \mathbf{v}_2, \mathbf{v}_3\}$ to $\{\mathbf{v}_i, \mathbf{v}_j, \mathbf{v}_k\}$. Find the matrix representation of this operator and show that $\det \mathbf{E} = \epsilon_{ijk}$.

26.14 Starting with the definition of the permutation tensor $\delta_{j_1 j_2 \dots j_N}^{i_1 i_2 \dots i_N}$, and writing the wedge product in terms of the antisymmetrized tensor product, show that

$$\delta_{j_1 j_2 \dots j_N}^{i_1 i_2 \dots i_N} = \sum_{\pi} \epsilon_{\pi(j_1)\pi(j_2)\dots\pi(j_N)} \delta_{\pi(j_1)}^{i_1} \delta_{\pi(j_2)}^{i_2} \cdots \delta_{\pi(j_N)}^{i_N}.$$

26.15 Derive Eqs. (26.49) and (26.50).

26.16 Show that a 2-form ω is nondegenerate if and only if the determinant of (ω_{ij}) is nonzero if and only if ω^b is an isomorphism.

26.17 Let \mathcal{V} be a finite-dimensional vector space and $\omega \in \Lambda^2(\mathcal{V})$. Suppose there exist a pair of vectors $\mathbf{e}_1, \mathbf{e}'_1 \in \mathcal{V}$ such that $\omega(\mathbf{e}_1, \mathbf{e}'_1) \neq 0$. Let \mathcal{P}_1 be the plane spanned by \mathbf{e}_1 and \mathbf{e}'_1 , and \mathcal{V}_1 the ω -orthogonal complement of \mathcal{P}_1 . Show that $\mathcal{V}_1 \cap \mathcal{P}_1 = 0$, and that $\mathbf{v} - \omega(\mathbf{v}, \mathbf{e}'_1)\mathbf{e}_1 + \omega(\mathbf{v}, \mathbf{e}_1)\mathbf{e}'_1$ is in \mathcal{V}_1 .

26.18 Show that $\sum_{j=1}^n \epsilon^j \wedge \epsilon^{j+n}$, in which $\{\epsilon^j\}_{j=1}^N$ is dual to $\{\mathbf{e}_i\}_{i=1}^N$, the canonical basis of a symplectic vector space \mathcal{V} , has the same matrix as ω .

26.19 Suppose that \mathcal{V} is a symplectic vector space and $\mathbf{v}, \mathbf{v}' \in \mathcal{V}$ are expressed in a canonical basis of \mathcal{V} with coefficients $\{x_i, y_i, z_i\}$ and $\{x'_i, y'_i, z'_i\}$. Show that

$$\omega(\mathbf{v}, \mathbf{v}') = \sum_{i=1}^n (x_i y'_i - x'_i y_i).$$

26.20 Let \mathcal{V} be a vector space and \mathcal{V}^* its dual. Define $\omega \in \Lambda^2(\mathcal{V} \oplus \mathcal{V}^*)$ by

$$\omega(\mathbf{v} + \boldsymbol{\varphi}, \mathbf{v}' + \boldsymbol{\varphi}') \equiv \boldsymbol{\varphi}'(\mathbf{v}) - \boldsymbol{\varphi}(\mathbf{v}')$$

where $\mathbf{v}, \mathbf{v}' \in \mathcal{V}$ and $\boldsymbol{\varphi}, \boldsymbol{\varphi}' \in \mathcal{V}^*$. Show that $(\mathcal{V} \oplus \mathcal{V}^*, \omega)$ is a symplectic vector space.

26.21 By taking successive powers of ω show that

$$\omega^k = \sum_{j_1 \dots j_k=1}^n \epsilon^{j_1} \wedge \epsilon^{j_1+n} \wedge \dots \wedge \epsilon^{j_k} \wedge \epsilon^{j_k+n}.$$

Conclude that

$$\omega^n = n!(-1)^{[n/2]} \epsilon^1 \wedge \dots \wedge \epsilon^{2n},$$

where $[n/2]$ is the largest integer less than or equal to $n/2$.

26.22 Show that the condition for a matrix A to be symplectic is $A^t J A = J$ where $J = \begin{pmatrix} 0 & 1 \\ -1 & 0 \end{pmatrix}$ is the representation of ω in the canonical basis.

26.23 Show that $Sp(\mathcal{V}, \omega)$ is a subgroup of $GL(\mathcal{V})$.

26.24 Show that the linear operator \mathbf{g}_W defined in Lemma 26.5.13 is onto.

26.25 (a) Show that the inverse of the (diagonal) matrix of \mathbf{g} in an orthonormal basis is the same as the matrix of \mathbf{g} .

(b) Now show that $\epsilon^{12\dots N} = (-1)^v \epsilon_{12\dots N} = (-1)^v$.

26.26 Let $\{\mathbf{e}_i\}_{i=1}^N$ be a g -orthonormal basis of \mathcal{V} . Let $\boldsymbol{\eta}$ be the matrix with elements η_{ij} , which is the matrix of \mathbf{g} in this orthonormal basis. Let $\{\mathbf{v}_j\}_{j=1}^N$ be another (not necessarily orthonormal) basis of \mathcal{V} with a transformation matrix R , i.e., $\mathbf{v}_i = r_i^j \mathbf{e}_j$.

- (a) Using \mathbf{G} to denote the matrix of \mathbf{g} in $\{\mathbf{v}_j\}_{j=1}^N$, show that

$$\det \mathbf{G} = \det \boldsymbol{\eta} (\det \mathbf{R})^2 = (-1)^{\nu} (\det \mathbf{R})^2.$$

In particular, the sign of this determinant is invariant. Why is $\det \mathbf{G}$ not equal to $\det \boldsymbol{\eta}$? Is there any conflict with the statement that the determinant is basis-independent?

- (b) Let $\boldsymbol{\mu}$ be the volume element related to \mathbf{g} , and let $|G| = |\det \mathbf{G}|$. Show that if $\{\mathbf{v}_j\}_{j=1}^N$ is positively oriented relative to $\boldsymbol{\mu}$, then

$$\boldsymbol{\mu} = |G|^{1/2} \mathbf{v}_1 \wedge \mathbf{v}_2 \wedge \cdots \wedge \mathbf{v}_N.$$

26.27 Let \mathbf{b} be a symmetric bilinear form. Show that the kernel of $\mathbf{b}_* : \mathcal{V} \rightarrow \mathcal{V}^*$ consists of all vectors $\mathbf{u} \in \mathcal{V}$ such that $\mathbf{b}(\mathbf{u}, \mathbf{v}) = 0$ for all $\mathbf{v} \in \mathcal{V}$. Show also that in the \mathbf{b} -orthonormal basis $\{\mathbf{e}_j\}$, the set $\{\mathbf{e}_i \mid \mathbf{b}(\mathbf{e}_i, \mathbf{e}_i) = 0\}$ is a basis of $\ker \mathbf{b}$, and therefore the set of linearly independent isotropic vectors is the nullity of \mathbf{b} .

26.28 For this problem, we return to the Dirac bra and ket notation. Let \mathbf{T} be an isometry in the real vector space \mathcal{V} . Then $|y\rangle = (\mathbf{T} - \mathbf{1})|x\rangle$ is the vector, which, in three-dimensions, connects the tip of $|x\rangle$ to its isometric image.

- (a) Show that $\langle y|y\rangle = 2\langle x|(\mathbf{1} - \mathbf{T})|x\rangle$.
 (b) Show that

$$\mathbf{P}_y = (\mathbf{T} - \mathbf{1}) \frac{|x\rangle\langle x|}{2\langle x|(\mathbf{1} - \mathbf{T})|x\rangle} (\mathbf{T}^t - \mathbf{1})$$

and

$$\mathbf{R}_y = \mathbf{1} - (\mathbf{T} - \mathbf{1}) \frac{|x\rangle\langle x|}{\langle x|(\mathbf{1} - \mathbf{T})|x\rangle} (\mathbf{T}^t - \mathbf{1}).$$

- (c) Verify that $\mathbf{R}_y|x\rangle = \mathbf{T}|x\rangle$, as we expect.

26.29 Use Eq. (26.51) to show that for a 3×3 matrix \mathbf{A} ,

$$\det \mathbf{A} = \frac{1}{3!} [(\operatorname{tr} \mathbf{A})^3 - 3 \operatorname{tr} \mathbf{A} \operatorname{tr}(\mathbf{A}^2) + 2 \operatorname{tr}(\mathbf{A}^3)].$$

26.30 Find the index and the signature for the bilinear form \mathbf{g} on \mathbb{R}^3 given by $\mathbf{g}(\mathbf{v}_1, \mathbf{v}_2) = x_1 y_2 + x_2 y_1 - y_1 z_2 - y_2 z_1$.

26.31 In relativistic electromagnetic theory the current \mathbf{J} and the electromagnetic field tensor \mathbf{F} are, respectively, a four-vector⁸ and an antisymmetric tensor of rank 2. That is, $\mathbf{J} = J^k \mathbf{e}_k$ and $\mathbf{F} = F^{ij} \mathbf{e}_i \wedge \mathbf{e}_j$. Find the components of $*\mathbf{J}$ and $*\mathbf{F}$. Recall that the space of relativity is a 4D Minkowski space.

⁸It turns out to be more natural to consider \mathbf{J} as a 3-form. However, such a fine distinction is not of any consequence for the present discussion.

26.32 Show that $\epsilon_{j_1 j_2 \dots j_N} R_{i_1}^{j_1} \dots R_{i_N}^{j_N} = \epsilon_{i_1 i_2 \dots i_N} \det R$.

26.33 Prove Theorem 26.6.4.

26.34 Show that where there is a sum over an upper index and a lower index, swapping the upper index to a lower index, and vice versa, does not change the sum. In other words, $A^i B_i = A_i B^i$.

26.35 Show the following vector identities, using the definition of cross products in terms of ϵ_{ijk} .

- (a) $\mathbf{A} \times \mathbf{A} = 0$.
- (b) $\nabla \cdot (\mathbf{A} \times \mathbf{B}) = (\nabla \times \mathbf{A}) \cdot \mathbf{B} - (\nabla \times \mathbf{B}) \cdot \mathbf{A}$.
- (c) $\nabla \times (\mathbf{A} \times \mathbf{B}) = (\mathbf{B} \cdot \nabla) \mathbf{A} + \mathbf{A} (\nabla \cdot \mathbf{B}) - (\mathbf{A} \cdot \nabla) \mathbf{B} - \mathbf{B} (\nabla \cdot \mathbf{A})$.
- (d) $\nabla \times (\nabla \times \mathbf{A}) = \nabla (\nabla \cdot \mathbf{A}) - \nabla^2 \mathbf{A}$.

26.36 A vector operator \mathbf{V} is defined as a set of three operators, $\{\mathbf{V}^1, \mathbf{V}^2, \mathbf{V}^3\}$, satisfying the following commutation relations with angular momentum: $[\mathbf{V}^i, \mathbf{J}^j] = i\epsilon^{ijk} \mathbf{V}^k$. Show that $\mathbf{V}^k \mathbf{V}^k$ commutes with all components of angular momentum.

26.37 The Pauli spin matrices

$$\sigma^1 = \begin{pmatrix} 0 & 1 \\ 1 & 0 \end{pmatrix}, \quad \sigma^2 = \begin{pmatrix} 0 & -i \\ i & 0 \end{pmatrix}, \quad \sigma^3 = \begin{pmatrix} 1 & 0 \\ 0 & -1 \end{pmatrix}$$

describe a particle with spin $\frac{1}{2}$ in nonrelativistic quantum mechanics. Verify that these matrices satisfy

$$[\sigma^i, \sigma^j] \equiv \sigma^i \sigma^j - \sigma^j \sigma^i = 2i\epsilon_k^{ij} \sigma^k, \quad \{\sigma^i, \sigma^j\} \equiv \sigma^i \sigma^j + \sigma^j \sigma^i = 2\delta_j^i \mathbf{1}_2,$$

where $\mathbf{1}_2$ is the unit 2×2 matrix. Show also that $\sigma^i \sigma^j = i\epsilon_k^{ij} \sigma^k + \delta_j^i \mathbf{1}_2$, and for any two vectors \mathbf{a} and \mathbf{b} , $(\boldsymbol{\sigma} \cdot \mathbf{a})(\boldsymbol{\sigma} \cdot \mathbf{b}) = \mathbf{a} \cdot \mathbf{b} \mathbf{1}_2 + i\boldsymbol{\sigma} \cdot (\mathbf{a} \times \mathbf{b})$.

26.38 Show that any contravariant tensor of rank two can be written as the sum of a symmetric tensor and an antisymmetric tensor. Can this be generalized to tensors of arbitrary rank?

The last chapter introduced the exterior product, which multiplied a p -vector and a q -vector to yield a $(p + q)$ -vector. By directly summing the spaces of all such vectors, we obtained a vector space which was closed under multiplication. This led to a 2^n -dimensional algebra, which we called the exterior algebra (see Theorem 26.3.6).

In the meantime we revisited inner product and considered non-Euclidean inner products, which are of physical significance. In this chapter, we shall combine the exterior product with the inner product to create a new type of algebra, the Clifford algebra, which happens to have important applications in physics.

In our definition of exterior product in the previous chapter, we assumed that the number of vectors was equal to the number of linear functionals taken from the dual space [see Eq. (26.14)]. As a result of this complete pairing, we always ended up with a number. It is useful, however, to define an “incomplete” pairing in which the number of vectors and dual vectors are not the same. In particular, if we have a p -vector and a single 1-form, then we can pair the 1-form with one of the factors of the p -vector to get a $(p - 1)$ -vector. This process is important enough to warrant the following:

Definition 27.0.1 Let \mathbf{A} be a p -vector and θ a 1-form in a vector space \mathcal{V} . Then define $i_\theta : \Lambda^p(\mathcal{V}^*) \rightarrow \Lambda^{p-1}(\mathcal{V}^*)$ by

$$i_\theta \mathbf{A}(\theta_1, \dots, \theta_{p-1}) = \mathbf{A}(\theta, \theta_1, \dots, \theta_{p-1}).$$

interior product of a 1-form and a p -vector

$i_\theta \mathbf{A}$ is called the **interior product** or **contraction** of θ and \mathbf{A} .

Note that if \mathbf{A} is a 1-vector \mathbf{v} , then $i_\theta \mathbf{v} = \langle \theta, \mathbf{v} \rangle$, and if it is a real number α , then (by definition) $i_\theta \alpha = 0$.

An immediate consequence of Definition 27.0.1 is the following:

Theorem 27.0.2 Let \mathbf{A} be a p -vector and \mathbf{B} be a q -vector on a vector space \mathcal{V} . Then, i_θ is an **antiderivation** with respect to the wedge product:

antiderivation

$$i_\theta(\mathbf{A} \wedge \mathbf{B}) = (i_\theta \mathbf{A}) \wedge \mathbf{B} + (-1)^p \mathbf{A} \wedge (i_\theta \mathbf{B}).$$

If $(\mathcal{V}, \mathbf{g})$ is an inner product space, we can define the interior product of a 1-vector \mathbf{v} and a p -vector \mathbf{A} . In fact, if $\mathbf{g}_* : \mathcal{V} \rightarrow \mathcal{V}^*$ is as defined in Eq. (26.30), then let

$$i_{\mathbf{v}}\mathbf{A} \equiv i_{\mathbf{g}_*(\mathbf{v})}\mathbf{A}. \quad (27.1)$$

In particular, if \mathbf{A} is a vector \mathbf{u} , then $i_{\mathbf{v}}\mathbf{u} = \mathbf{g}(\mathbf{u}, \mathbf{v})$.

27.1 Construction of Clifford Algebras

Let \mathcal{V} be a real vector space with inner product \mathbf{g} . Let $\mathbf{v} \in \mathcal{V}$ and $\mathbf{A} \in \Lambda^p(\mathcal{V}^*)$. Define the product $\vee : \mathcal{V} \times \Lambda^p(\mathcal{V}^*) \rightarrow \Lambda^{p+1}(\mathcal{V}^*) \oplus \Lambda^{p-1}(\mathcal{V}^*)$ by

Clifford product

$$\mathbf{v} \vee \mathbf{A} = \mathbf{v} \wedge \mathbf{A} + i_{\mathbf{v}}\mathbf{A} \quad (27.2)$$

where $i_{\mathbf{v}}\mathbf{A}$ is as defined in Eq. (27.1). This product is called the **Clifford product**.

The special case of $p = 1$ is of importance. For such a case, we obtain

$$\mathbf{v} \vee \mathbf{u} = \mathbf{v} \wedge \mathbf{u} + i_{\mathbf{v}}\mathbf{u} = \mathbf{v} \wedge \mathbf{u} + \mathbf{g}(\mathbf{u}, \mathbf{v}) \quad (27.3)$$

which can also be written as

$$\mathbf{v} \vee \mathbf{u} + \mathbf{u} \vee \mathbf{v} = 2\mathbf{g}(\mathbf{u}, \mathbf{v}). \quad (27.4)$$

This equation is sometimes taken as the definition of the Clifford product and the starting point of the Clifford algebra (to be discussed below).

We see that the Clifford product has been defined on the vector space which underlies the exterior algebra. However, the left factor in the Clifford product is just a vector, not a general member of the exterior algebra. Is it possible to define Clifford product of a q -vector and a p -vector? It is indeed possible if we assume that \vee is associative and distributes over addition. To show this, pick a basis and write a q -vector in terms of that basis. Thus, let \mathbf{A} be as before and let $\mathbf{B} \in \Lambda^q(\mathcal{V}^*)$, and write

$$\mathbf{B} = \frac{1}{q!} b^{j_1 \dots j_q} \mathbf{e}_{j_1} \wedge \dots \wedge \mathbf{e}_{j_q}.$$

Then

$$\begin{aligned} q!\mathbf{B} \vee \mathbf{A} &= b^{j_1 \dots j_q} \mathbf{e}_{j_1} \wedge \dots \wedge \mathbf{e}_{j_q} \vee \mathbf{A} \\ &= b^{j_1 \dots j_q} \mathbf{e}_{j_1} \wedge \dots \wedge \mathbf{e}_{j_{q-2}} \wedge (\mathbf{e}_{j_{q-1}} \vee \mathbf{e}_{j_q} + g_{j_q j_{q-1}}) \vee \mathbf{A} \\ &= b^{j_1 \dots j_q} \mathbf{e}_{j_1} \wedge \dots \wedge \mathbf{e}_{j_{q-2}} \wedge (\mathbf{e}_{j_{q-1}} \vee \mathbf{e}_{j_q} \vee \mathbf{A}) \end{aligned} \quad (27.5)$$

because $g_{j_q j_{q-1}}$ is symmetric under the exchange of j_q and j_{q-1} while $b^{j_1 \dots j_q}$ is antisymmetric. To continue, we use Eq. (27.2) and rewrite the term in the parentheses on the last line of Eq. (27.5):

$$\begin{aligned}
 \mathbf{e}_{j_{q-1}} \vee \mathbf{e}_{j_q} \vee \mathbf{A} &= \mathbf{e}_{j_{q-1}} \vee (\mathbf{e}_{j_q} \wedge \mathbf{A} + i_{\mathbf{e}_{j_q}} \mathbf{A}) \\
 &= \mathbf{e}_{j_{q-1}} \vee (\mathbf{e}_{j_q} \wedge \mathbf{A}) + \mathbf{e}_{j_{q-1}} \vee (i_{\mathbf{e}_{j_q}} \mathbf{A}) \\
 &= \mathbf{e}_{j_{q-1}} \wedge (\mathbf{e}_{j_q} \wedge \mathbf{A}) + i_{\mathbf{e}_{j_{q-1}}} (\mathbf{e}_{j_q} \wedge \mathbf{A}) \\
 &\quad + \mathbf{e}_{j_{q-1}} \wedge (i_{\mathbf{e}_{j_q}} \mathbf{A}) + i_{\mathbf{e}_{j_{q-1}}} (i_{\mathbf{e}_{j_q}} \mathbf{A}) \\
 &= \mathbf{e}_{j_{q-1}} \wedge \mathbf{e}_{j_q} \wedge \mathbf{A} + g_{j_q j_{q-1}} \mathbf{A} - \mathbf{e}_{j_q} \wedge (i_{\mathbf{e}_{j_{q-1}}} \mathbf{A}) \\
 &\quad + \mathbf{e}_{j_{q-1}} \wedge (i_{\mathbf{e}_{j_q}} \mathbf{A}) + i_{\mathbf{e}_{j_{q-1}}} (i_{\mathbf{e}_{j_q}} \mathbf{A}),
 \end{aligned}$$

where in the last equality, we used the antiderivation property of the interior product (Theorem 27.0.2). Substituting the last equation in (27.5) yields

$$\begin{aligned}
 q! \mathbf{B} \vee \mathbf{A} &= q! \mathbf{B} \wedge \mathbf{A} + b^{j_1 \dots j_q} \mathbf{e}_{j_1} \wedge \dots \wedge \mathbf{e}_{j_{q-2}} \wedge \mathbf{e}_{j_{q-1}} \wedge (i_{\mathbf{e}_{j_q}} \mathbf{A}) \\
 &\quad - b^{j_1 \dots j_q} \mathbf{e}_{j_1} \wedge \dots \wedge \mathbf{e}_{j_{q-2}} \wedge \mathbf{e}_{j_q} \wedge (i_{\mathbf{e}_{j_{q-1}}} \mathbf{A}) \\
 &\quad + b^{j_1 \dots j_q} \mathbf{e}_{j_1} \wedge \dots \wedge \mathbf{e}_{j_{q-2}} \wedge [i_{\mathbf{e}_{j_{q-1}}} (i_{\mathbf{e}_{j_q}} \mathbf{A})]. \tag{27.6}
 \end{aligned}$$

The right-hand side is given entirely in terms of wedge products, which are known operations. Hence, the Clifford product of any p -vector and q -vector can be defined, and this product is in $\Lambda(\mathcal{V}^*)$ of Theorem 26.3.6. Thus, $\Lambda(\mathcal{V}^*)$ is an algebra not only under the wedge product but also under the Clifford product. With the latter as the multiplication rule, $\Lambda(\mathcal{V}^*)$ is called a **Clifford algebra** and denoted by $\mathcal{C}_{\mathcal{V}}$.

Clifford algebra

Historical Notes

At the age of 15 **William Clifford** went to King’s College, London where he excelled in mathematics, classics, English literature, and gymnastics. Three years later, he entered Trinity College, Cambridge, where he won not only prizes for mathematics but also one for a speech he delivered on Sir Walter Raleigh. In 1868, he was elected to a Fellowship at Trinity, and three years later, he was appointed to the chair of Mathematics and Mechanics at University College London. In 1874 he was elected a Fellow of the Royal Society. He was also an active member of the London Mathematical Society which held its meetings at University College.



William Clifford
1845–1879

Clifford read the work of Riemann and Lobachevsky on non-euclidean geometry, and became interested in the subject. Almost 50 years before the advent of Einstein’s general theory of relativity, he wrote *On the space theory of matter* in which he argued that energy and matter are different aspects of the curvature of space.

Clifford generalised the quaternions (introduced by Hamilton two years before Clifford’s birth) to what he called the biquaternions and he used them to study motion in non-euclidean spaces and on certain surfaces.

As a teacher, Clifford’s reputation was outstanding and famous for his clarity of explanation of difficult mathematical problems. Not only was he a highly original teacher and researcher, he was also a philosopher of science. At the age of 23 he delivered a lecture to the Royal Institution entitled *Some of the conditions of mental development*, in which he tried to explain how scientific discovery comes about.

He was eccentric in appearance, habits and opinions. A fellow undergraduate describes him as follows: “His neatness and dexterity were unusually great, but the most remarkable thing was his great strength as compared with his weight. At one time he would pull up on the bar with either hand.”

Like another British mathematician, Charles Dodgson, he took pleasure in entertaining children. Although he never achieved Dodgson’s success in writing such books as *Alice’s Adventures in Wonderland* (which the latter wrote under the pseudonym Lewis Carroll), Clifford wrote *The Little People*, a collection of fairy stories written to amuse children.

In 1876 Clifford suffered a physical collapse, which was made worse by overwork, and most likely, caused by it. He would spend the entire day teaching and doing administrative work, and the entire night doing research. Spending six months in Algeria and Spain allowed him to recover sufficiently to resume his work. But after 18 months he collapsed again, after which he spent some time in Mediterranean countries, but this was not enough to improve his health. After a couple of months in England in late 1878, he left for Madeira. The hoped-for recovery never materialized and he died a few months later.

We have shown that the Clifford product of a p -vector and a q -vector lies in $\Lambda(\mathcal{V}^*)$. This implies that the underlying vector space of the Clifford algebra is a subspace of $\Lambda(\mathcal{V}^*)$. However, it can be shown that the set of Clifford products exhaust the entire $\Lambda(\mathcal{V}^*)$; i.e., that the Clifford algebra is 2^N -dimensional. This follows from the fact that a p -vector \mathbf{A} , which can be written as

$$\mathbf{A} = \frac{1}{p!} a^{i_1 i_2 \dots i_p} \mathbf{e}_{i_1} \wedge \mathbf{e}_{i_2} \wedge \dots \wedge \mathbf{e}_{i_p}, \quad (27.7)$$

can also be written as

$$\mathbf{A} \rightarrow \mathbf{a} = \frac{1}{p!} a^{i_1 i_2 \dots i_p} \mathbf{e}_{i_1} \vee \mathbf{e}_{i_2} \vee \dots \vee \mathbf{e}_{i_p}, \quad (27.8)$$

where we have introduced a new notation to differentiate between members of the exterior algebra and the Clifford algebra. The details of the derivation of (27.8) from (27.7) are given as Problem 27.1.

27.1.1 The Dirac Equation

The interest in the Clifford algebra in the physics community came about after Dirac discovered the relativistic wave equation for an electron. As is usually the case, when a mathematical topic finds its way into physics, a healthy collaboration between physicists and mathematicians sets in and the topic becomes an active area of research in both fields. Dirac's discovery and its connection with the Clifford algebra has led to some fundamental results in many branches of mathematics. It is therefore worthwhile to see how Dirac discovered the equation that now bears his name.

The transition from classical to quantum mechanics is made by changing the energy E and momentum \mathbf{p} to derivative operators:¹ $E \rightarrow i\partial/\partial t$ and $\mathbf{p} \rightarrow -i\nabla$ which act on the wave function ψ . Thus a non-relativistic free particle, whose energy and momentum are related by $E = p^2/2m$, is described by the Schrödinger equation

$$i \frac{\partial \psi}{\partial t} = \frac{(-i\nabla)^2}{2m} \psi \quad \text{or} \quad i \frac{\partial \psi}{\partial t} = -\frac{1}{2m} \nabla^2 \psi.$$

The relativistic energy-momentum relation, $E^2 - p^2 = m^2$, leads to Klein-Gordon equation whose time derivative is of second order. Although eventually accepted as a legitimate equation for relativistic particles, Klein-

¹We are using the natural units for which the Planck constant (over 2π) and the speed of light are set to 1: $\hbar = 1 = c$.

Gordon equation was initially abandoned because, due to its second derivative in time, it gave rise to negative probabilities. Therefore, it was desirable to find a relativistic equation which was first order in time derivative, and Dirac found precisely such an equation.

Dirac's idea was to factor out $E^2 - p^2$ into $(E - p)(E + p)$ and to somehow incorporate the mass term in the factorization. We avoid writing E and \mathbf{p} as derivatives, but consider them as commuting operators. Since it is not possible to include m in a straightforward factorization, Dirac came up with the ingenious idea of multiplying E and \mathbf{p} operators by quantities to be determined by certain consistency conditions. More precisely, he considered an equation of the form

$$\left(\beta E + \sum_{i=1}^3 \alpha_i p_i + m \right) \psi = 0,$$

and demanded that β and α_i be chosen in such way that

$$\left(\beta E + \sum_{j=1}^3 \alpha_j p_j - m \right) \left(\beta E + \sum_{i=1}^3 \alpha_i p_i + m \right) \psi = 0 \quad (27.9)$$

reduce to

$$\left(E^2 - \sum_{i=1}^3 p_i^2 - m^2 \right) \psi = 0. \quad (27.10)$$

Multiplying the two parentheses above, we obtain

$$\begin{aligned} & \beta^2 E^2 + \sum_{i=1}^3 \beta \alpha_i E p_i + \beta m E + \sum_{j=1}^3 \alpha_j \beta E p_j + \sum_{i,j=1}^3 \alpha_j \alpha_i p_j p_i \\ & + \sum_{j=1}^3 m \alpha_j p_j - \beta m E - \sum_{i=1}^3 m \alpha_i p_i - m^2 \\ & = \beta^2 E^2 + \sum_{i=1}^3 (\beta \alpha_i + \alpha_i \beta) E p_i + \frac{1}{2} \sum_{i,j=1}^3 (\alpha_j \alpha_i + \alpha_i \alpha_j) p_i p_j - m^2. \end{aligned}$$

For this to be equal to the expression in parentheses of Eq. (27.10), we need to have

$$\beta^2 = 1, \quad \beta \alpha_i + \alpha_i \beta = 0, \quad \frac{1}{2} (\alpha_j \alpha_i + \alpha_i \alpha_j) = -\delta_{ij}.$$

The last condition is the result of the fact that $p_j p_i$ is symmetric in ij , and therefore, its product with the antisymmetric part of $\alpha_i \alpha_j$ automatically vanishes. Letting $\beta \equiv \gamma^0$ and $\alpha_i = \gamma^i$, the above conditions can be condensed into the single condition

$$\gamma^\mu \gamma^\nu + \gamma^\nu \gamma^\mu = 2\eta^{\mu\nu}. \quad (27.11)$$

This equation is identical to (27.4), hence the connection between the Dirac equation and Clifford algebra.

It is clear that Eq. (27.11) cannot hold if the γ s are ordinary numbers. In fact, Dirac showed that they have to be 4×4 matrices, now called **Dirac γ matrices**. If the γ s are 4×4 matrices, then ψ must be a column vector with 4 components. It turns out that two of these components correspond to the two components of the electron spin. It took a while before the other two components were identified as those of the antiparticle of the electron, namely positron.

27.2 General Properties of the Clifford Algebra

Equation (27.8) implies that a vector in $\Lambda(\mathcal{V}^*)$, being a direct sum of p -vectors for different p 's, can be expressed as a linear combination of the basis vectors of $\Lambda^P(\mathcal{V}^*)$, where the basis vectors are given as Clifford product (rather than the wedge product) of the basis vectors of \mathcal{V} :

Theorem 27.2.1 *Let $\{\mathbf{e}_i\}_{i=1}^N$ be a basis of an inner product space \mathcal{V} . Then the 2^N vectors*

$$\mathbf{1}, \mathbf{e}_i, \mathbf{e}_i \vee \mathbf{e}_j (i < j), \mathbf{e}_i \vee \mathbf{e}_j \vee \mathbf{e}_k, (i < j < k), \dots, \mathbf{e}_1 \vee \mathbf{e}_2 \vee \dots \vee \mathbf{e}_N$$

form a basis of \mathcal{C}_V .

Thus, if \mathbf{u} is an arbitrary vector of $\Lambda(\mathcal{V}^*)$, then it can be expressed as follows:

$$\mathbf{u} = \alpha \mathbf{1} + u^i \mathbf{e}_i + u^{|i_1 i_2|} \mathbf{e}_{i_1} \vee \mathbf{e}_{i_2} + \dots + u^{|i_1 \dots i_N|} \mathbf{e}_{i_1} \vee \dots \vee \mathbf{e}_{i_N} \quad (27.12)$$

where $|i_1 i_2 \dots i_p|$ means that the sum over repeated indices is over $i_1 < i_2 < \dots < i_p$. Equation (27.12) is sometimes written as

$$\mathbf{u} = \alpha \mathbf{1} + u^i \mathbf{e}_i + \frac{1}{2!} u^{i_1 i_2} \mathbf{e}_{i_1} \vee \mathbf{e}_{i_2} + \dots + \frac{1}{N!} u^{i_1 \dots i_N} \mathbf{e}_{i_1} \vee \dots \vee \mathbf{e}_{i_N} \quad (27.13)$$

where the coefficients are assumed completely antisymmetric in all their indices, but the sum has no ordering.

Note the appearance of $\mathbf{1}$ in the sum multiplying the scalar α . This suggests changing (27.4) to

$$\mathbf{v} \vee \mathbf{u} + \mathbf{u} \vee \mathbf{v} = 2\mathbf{g}(\mathbf{u}, \mathbf{v})\mathbf{1}, \quad (27.14)$$

which, when specialized to the basis vectors, becomes

$$\mathbf{e}_i \mathbf{e}_j + \mathbf{e}_j \mathbf{e}_i = 2g_{ij}\mathbf{1}, \quad \mathbf{e}_i^2 \equiv \mathbf{e}_i \vee \mathbf{e}_i = g_{ii}\mathbf{1}, \quad (27.15)$$

where we have removed the multiplication sign \vee , a practice which we shall often adhere to from now on. Equation (27.15) completely frees the Clifford algebra from the exterior algebra, with which we started our discussion. This is easily seen in an orthonormal basis:

$$\mathbf{e}_i^2 = \pm \mathbf{1}, \quad \mathbf{e}_i \mathbf{e}_j = -\mathbf{e}_j \mathbf{e}_i \quad \text{if } i \neq j. \quad (27.16)$$

Multiplying elements \mathbf{u} and \mathbf{v} , each expressed as in (27.12) or (27.13), reduces to the multiplication of various Clifford products of the basis vectors. In such multiplications, one commutes the basis vectors which appear twice in the product using (27.16) until all repetitions disappear and one regains Clifford products of basis vectors appearing in (27.13). The following example should clarify this.

Example 27.2.2 Let \mathcal{V} be a 2-dimensional Euclidean vector space (i.e., $g_{ij} = \delta_{ij}$) with the orthonormal basis $\{\mathbf{e}_1, \mathbf{e}_2\}$. Consider two elements \mathbf{u} and \mathbf{v} of the Clifford algebra over \mathcal{V} . These can very generally be written as

$$\begin{aligned} \mathbf{u} &= \alpha_u \mathbf{1} + \beta_u^1 \mathbf{e}_1 + \beta_u^2 \mathbf{e}_2 + \gamma_u \mathbf{e}_1 \mathbf{e}_2 \\ \mathbf{v} &= \alpha_v \mathbf{1} + \beta_v^1 \mathbf{e}_1 + \beta_v^2 \mathbf{e}_2 + \gamma_v \mathbf{e}_1 \mathbf{e}_2 \end{aligned}$$

and

$$\begin{aligned} \mathbf{u} \vee \mathbf{v} &= (\alpha_u \mathbf{1} + \beta_u^1 \mathbf{e}_1 + \beta_u^2 \mathbf{e}_2 + \gamma_u \mathbf{e}_1 \mathbf{e}_2) \vee (\alpha_v \mathbf{1} + \beta_v^1 \mathbf{e}_1 + \beta_v^2 \mathbf{e}_2 + \gamma_v \mathbf{e}_1 \mathbf{e}_2) \\ &= \alpha_u \alpha_v \mathbf{1} + \alpha_u \beta_v^1 \mathbf{e}_1 + \alpha_u \beta_v^2 \mathbf{e}_2 + \alpha_u \gamma_v \mathbf{e}_1 \mathbf{e}_2 \\ &\quad + \alpha_v \beta_u^1 \mathbf{e}_1 + \underbrace{\beta_u^1 \beta_v^1 \mathbf{e}_1 \mathbf{e}_1}_{=1} + \beta_u^1 \beta_v^2 \mathbf{e}_1 \mathbf{e}_2 + \beta_u^1 \gamma_v \underbrace{\mathbf{e}_1 \mathbf{e}_1 \mathbf{e}_2}_{=1} \\ &\quad + \beta_u \alpha_v^2 \mathbf{e}_2 + \beta_u^2 \beta_v^1 \underbrace{\mathbf{e}_2 \mathbf{e}_1}_{-\mathbf{e}_1 \mathbf{e}_2} + \beta_u^2 \beta_v^2 \underbrace{\mathbf{e}_2 \mathbf{e}_2}_{=1} + \beta_u^2 \gamma_v \underbrace{\mathbf{e}_2 \mathbf{e}_1 \mathbf{e}_2}_{-\mathbf{e}_1 \mathbf{e}_2} \\ &\quad + \gamma_u \alpha_v \mathbf{e}_1 \mathbf{e}_2 + \gamma_u \beta_v^1 \underbrace{\mathbf{e}_1 \mathbf{e}_2 \mathbf{e}_1}_{-\mathbf{e}_1 \mathbf{e}_2} + \gamma_u \beta_v^2 \mathbf{e}_1 \underbrace{\mathbf{e}_2 \mathbf{e}_2}_{=1} + \gamma_u \gamma_v \underbrace{\mathbf{e}_1 \mathbf{e}_2 \mathbf{e}_1 \mathbf{e}_2}_{=-1}. \end{aligned}$$

We see that the right-hand side is a linear combination of $\mathbf{1}$, \mathbf{e}_1 , \mathbf{e}_2 , and $\mathbf{e}_1 \mathbf{e}_2$, as it should be since the Clifford algebra is closed under multiplication. Problem 27.2 asks you to find the coefficients of the linear combination.

Although we will primarily be dealing with real vector spaces, Eqs. (27.15) and (27.16) could be applied to complex vector spaces. Therefore, it is possible to have complex Clifford algebras, and we shall occasionally deal with such algebras as well.

If \mathbf{u} in (27.13) or (27.12) contains products of only even numbers of basis vectors, then it is called an **even element** of the algebra. The collection of all even elements of \mathcal{C}_V is a subalgebra of \mathcal{C}_V and is denoted by \mathcal{C}_V^0 . The **odd elements** are denoted by \mathcal{C}_V^1 , and although they form a subspace of \mathcal{C}_V , obviously, they do not form a subalgebra. As a vector space, \mathcal{C}_V is the direct sum of the even and odd subspaces:

$$\mathcal{C}_V = \mathcal{C}_V^0 \oplus \mathcal{C}_V^1. \tag{27.17}$$

The discussion above can be made slightly more formal.

Definition 27.2.3 Let ω be the linear automorphism of \mathcal{V} given by $\omega(\mathbf{a}) = -\mathbf{a}$ for all $\mathbf{a} \in \mathcal{V}$. The involution of the Clifford algebra \mathcal{C}_V induced by ω is called the **degree involution** and is denoted by ω_V .

Note that for any $\mathbf{u} \in \mathcal{C}_V$ given by (27.13), $\omega_V(\mathbf{u})$ is obtained by changing the sign of all the vectors in that equation. It is obvious that $\omega_V^2 = \iota$, where $\iota(\mathbf{u}) = \mathbf{u}$ for all $\mathbf{u} \in \mathcal{C}_V$. Thus, ω_V is indeed an involution of \mathcal{C}_V . Now, an involution has only two eigenvalues, ± 1 , and the intersection of the eigenspaces of these eigenvalues is zero. Moreover, we can identify these eigenspaces as \mathcal{C}_V^0 and \mathcal{C}_V^1 , where

$$\mathcal{C}_V^0 = \ker(\omega_V - \iota), \quad \mathcal{C}_V^1 = \ker(\omega_V + \iota). \quad (27.18)$$

Consider two inner product spaces \mathcal{V} and \mathcal{U} , and define the inner product on their direct sum $\mathcal{V} \oplus \mathcal{U}$ by

$$\langle \mathbf{v}_1 \oplus \mathbf{u}_1, \mathbf{v}_2 \oplus \mathbf{u}_2 \rangle \equiv \langle \mathbf{v}_1, \mathbf{v}_2 \rangle + \langle \mathbf{u}_1, \mathbf{u}_2 \rangle.$$

Then we have the following important theorem: (For a proof, see [Greu 78, p. 234])

Theorem 27.2.4 Let $\mathcal{W} = \mathcal{V} \oplus \mathcal{U}$. Then the Clifford algebra \mathcal{C}_W is isomorphic to the skew symmetric tensor product of \mathcal{C}_V and \mathcal{C}_U :

$$\mathcal{C}_W \equiv \mathcal{C}_{V \oplus U} \cong \mathcal{C}_V \hat{\otimes} \mathcal{C}_U.$$

The skew symmetric tensor product was defined for exterior algebras in Definition 26.3.7, but it can also be defined for Clifford algebras. One merely has to change \wedge to \vee . Note that the caret over \otimes signifies the *product* defined on the *space* $\mathcal{C}_V \otimes \mathcal{C}_U$. Thus, as vector spaces, $\mathcal{C}_{V \oplus U} \cong \mathcal{C}_V \otimes \mathcal{C}_U$. Since all Clifford algebras are direct sums of their even and odd subspaces, we have

$$\begin{aligned} \mathcal{C}_W^0 \oplus \mathcal{C}_W^1 &\cong (\mathcal{C}_V^0 \oplus \mathcal{C}_V^1) \otimes (\mathcal{C}_U^0 \oplus \mathcal{C}_U^1) \\ &\cong (\mathcal{C}_V^0 \otimes \mathcal{C}_U^0) \oplus (\mathcal{C}_V^0 \otimes \mathcal{C}_U^1) \oplus (\mathcal{C}_V^1 \otimes \mathcal{C}_U^0) \oplus (\mathcal{C}_V^1 \otimes \mathcal{C}_U^1). \end{aligned}$$

In particular,

$$\begin{aligned} \mathcal{C}_W^0 &\cong (\mathcal{C}_V^0 \otimes \mathcal{C}_U^0) \oplus (\mathcal{C}_V^1 \otimes \mathcal{C}_U^1) \\ \mathcal{C}_W^1 &\cong (\mathcal{C}_V^0 \otimes \mathcal{C}_U^1) \oplus (\mathcal{C}_V^1 \otimes \mathcal{C}_U^0). \end{aligned} \quad (27.19)$$

Furthermore, if we invoke the product of Definition 26.3.7 on the first equation above, we get

$$\mathcal{C}_W^0 \cong (\mathcal{C}_V^0 \hat{\otimes} \mathcal{C}_U^0) \oplus (\mathcal{C}_V^1 \hat{\otimes} \mathcal{C}_U^1). \quad (27.20)$$

The second equation in (27.19), when restricted to vector spaces themselves, yields

$$\mathcal{W} \cong (\mathbf{1}_V \otimes \mathcal{U}) \oplus (\mathcal{V} \otimes \mathbf{1}_U), \quad (27.21)$$

where $\mathbf{1}_V$ and $\mathbf{1}_U$ are the identities of \mathcal{C}_V and \mathcal{C}_U , respectively.

Consider the linear map $\sigma_V : \mathcal{C}_V \rightarrow \mathcal{C}_V^{\text{op}}$ given by

$$\sigma_V(\mathbf{a} \vee \mathbf{b}) = \sigma_V(\mathbf{b}) \vee \sigma_V(\mathbf{a}), \quad \sigma_V(\mathbf{v}) = \mathbf{v}, \quad \mathbf{a}, \mathbf{b} \in \mathcal{C}_V, \quad \mathbf{v} \in \mathcal{V}. \quad (27.22)$$

It is straightforward to show that σ_V is an involution and that it commutes with the degree involution:

$$\sigma_V \circ \omega_V = \omega_V \circ \sigma_V \quad (27.23)$$

Definition 27.2.5 The **conjugation** involution is defined as $\sigma_V \circ \omega_V$. The conjugation involution **conjugate** of an element $\mathbf{a} \in \mathcal{C}_V$ is

$$\bar{\mathbf{a}} = \sigma_V \circ \omega_V(\mathbf{a}).$$

In particular, $\bar{\mathbf{v}} = -\mathbf{v}$ if $\mathbf{v} \in \mathcal{V}$.

It is clear from the definition that

$$\overline{\mathbf{a} \vee \mathbf{b}} = \bar{\mathbf{b}} \vee \bar{\mathbf{a}}, \quad \mathbf{a}, \mathbf{b} \in \mathcal{C}_V.$$

We saw a special case of this relation in our discussion of the quaternions in Example 3.1.16.

27.2.1 Homomorphism with Other Algebras

Let \mathcal{V} be an inner product space and \mathcal{A} an algebra with identity. A linear map $\varphi : \mathcal{V} \rightarrow \mathcal{A}$ can always be extended to a unital homomorphism $\phi : \mathcal{C}_V \rightarrow \mathcal{A}$. Indeed, since \mathcal{C}_V consists of sums of Clifford products of vectors in \mathcal{V} , one simply has to define the action of ϕ on a product of vectors in \mathcal{V} . The obvious choice is

$$\phi(\mathbf{v}_1 \vee \mathbf{v}_2 \vee \cdots \vee \mathbf{v}_m) = \phi(\mathbf{v}_1)\phi(\mathbf{v}_2) \cdots \phi(\mathbf{v}_m)$$

where on the right-hand side the product in \mathcal{A} is denoted by juxtaposition. For ϕ to be extendable to a unital homomorphism, it has to be compatible with Eq. (27.14); i.e., it has to satisfy

$$\phi(\mathbf{v} \vee \mathbf{u}) + \phi(\mathbf{u} \vee \mathbf{v}) = 2\mathbf{g}(\mathbf{u}, \mathbf{v})\phi(\mathbf{1})$$

or, denoting $\mathbf{g}(\mathbf{u}, \mathbf{v})$ by $\langle \mathbf{u}, \mathbf{v} \rangle$,

$$\phi(\mathbf{v})\phi(\mathbf{u}) + \phi(\mathbf{u})\phi(\mathbf{v}) = 2\langle \mathbf{u}, \mathbf{v} \rangle \mathbf{1}_A. \quad (27.24)$$

By setting $\mathbf{u} = \mathbf{v}$, we obtain an equivalent condition

$$\phi(\mathbf{v})^2 = \langle \mathbf{v}, \mathbf{v} \rangle \mathbf{1}_A. \quad (27.25)$$

Example 27.2.6 Let $\varphi : \mathbb{R}^2 \rightarrow \mathcal{L}(\mathbb{R}^2)$ be a linear map. We want to extend it to a homomorphism $\phi : \mathcal{C}_{\mathbb{R}^2} \rightarrow \mathcal{L}(\mathbb{R}^2)$. It is convenient to identify $\mathcal{L}(\mathbb{R}^2)$ with the set of 2×2 matrices and write

$$\varphi(\mathbf{v}) = \begin{pmatrix} \alpha_{11} & \alpha_{12} \\ \alpha_{21} & \alpha_{22} \end{pmatrix}. \quad (27.26)$$

Let $\mathbf{v} = (\alpha, \beta)$. For the extension to be possible, according to Eq. (27.25), we must have

$$\begin{pmatrix} \alpha_{11} & \alpha_{12} \\ \alpha_{21} & \alpha_{22} \end{pmatrix} \begin{pmatrix} \alpha_{11} & \alpha_{12} \\ \alpha_{21} & \alpha_{22} \end{pmatrix} = (\alpha^2 + \beta^2) \begin{pmatrix} 1 & 0 \\ 0 & 1 \end{pmatrix}.$$

One convenient solution to this equation is $\alpha_{11} = \alpha = -\alpha_{22}$ and $\alpha_{12} = \alpha_{21} = \beta$. Hence, we write Eq. (27.26) as

$$\varphi(\alpha, \beta) = \begin{pmatrix} \alpha & \beta \\ \beta & -\alpha \end{pmatrix}. \quad (27.27)$$

Now let $\{\mathbf{e}_1, \mathbf{e}_2\}$ be the standard basis of \mathbb{R}^2 . Then $\{\mathbf{1}, \mathbf{e}_1, \mathbf{e}_2, \mathbf{e}_1 \vee \mathbf{e}_2\}$ is a basis of $\mathcal{C}_{\mathbb{R}^2}$. Furthermore, $\phi(\mathbf{1})$ is the 2×2 unit matrix, and by (27.27)

$$\varphi(\mathbf{e}_1) = \varphi(1, 0) = \begin{pmatrix} 1 & 0 \\ 0 & -1 \end{pmatrix}, \quad \varphi(\mathbf{e}_2) = \varphi(0, 1) = \begin{pmatrix} 0 & 1 \\ 1 & 0 \end{pmatrix},$$

$$\phi(\mathbf{e}_1 \vee \mathbf{e}_2) = \varphi(\mathbf{e}_1)\varphi(\mathbf{e}_2) = \begin{pmatrix} 1 & 0 \\ 0 & -1 \end{pmatrix} \begin{pmatrix} 0 & 1 \\ 1 & 0 \end{pmatrix} = \begin{pmatrix} 0 & 1 \\ -1 & 0 \end{pmatrix}.$$

It is easy to show (see Problem 27.7) that these 4 matrices form a basis of $\mathcal{L}(\mathbb{R}^2)$. Since ϕ maps a basis onto a basis, it is a linear isomorphism and therefore an algebra isomorphism. Thus, $\mathcal{C}_{\mathbb{R}^2} \cong \mathcal{L}(\mathbb{R}^2)$.

27.2.2 The Canonical Element

Strictly speaking, the identification of (27.8) with (27.7) should be considered as an isomorphism ϕ_V of $\Lambda(\mathcal{V}^*)$ and \mathcal{C}_V :

$$\phi_V(\mathbf{e}_{i_1} \wedge \mathbf{e}_{i_2} \wedge \cdots \wedge \mathbf{e}_{i_p}) = \mathbf{e}_{i_1} \vee \mathbf{e}_{i_2} \vee \cdots \vee \mathbf{e}_{i_p}. \quad (27.28)$$

Invoking Proposition 2.6.7, we conclude that,

Definition 27.2.7 Given a determinant function Δ in \mathcal{V} , there is a unique canonical element $\mathbf{e}_\Delta \in \mathcal{C}_V$ such that

$$\phi_V(\mathbf{e}_{i_1} \wedge \cdots \wedge \mathbf{e}_{i_N}) = \Delta(\mathbf{e}_{i_1}, \dots, \mathbf{e}_{i_N}) \cdot \mathbf{e}_\Delta. \quad (27.29)$$

\mathbf{e}_Δ is called the **canonical element** in \mathcal{C}_V with respect to the determinant function Δ .

Now choose an orthogonal basis $\{\mathbf{e}_i\}_{i=1}^N$ in \mathcal{V} for which $\Delta(\mathbf{e}_{i_1}, \dots, \mathbf{e}_{i_N}) = 1$. Then, (27.28) and (27.29) yield

$$\mathbf{e}_\Delta = \mathbf{e}_1 \vee \dots \vee \mathbf{e}_N. \tag{27.30}$$

Next use the Lagrange identity (26.32) and write it in the form

$$\det(\langle \mathbf{x}_i, \mathbf{y}_j \rangle) = \lambda_\Delta \Delta(\mathbf{x}_1, \dots, \mathbf{x}_N) \Delta(\mathbf{y}_1, \dots, \mathbf{y}_N) \quad \mathbf{x}_i, \mathbf{y}_j \in \mathcal{V}. \tag{27.31}$$

Setting $\mathbf{x}_i = \mathbf{y}_i = \mathbf{e}_i$, and evaluating the determinant on the left-hand side of the equation, we obtain

$$\begin{aligned} \lambda_\Delta &= \langle \mathbf{e}_1, \mathbf{e}_1 \rangle \dots \langle \mathbf{e}_N, \mathbf{e}_N \rangle = g_{11} \dots g_{NN} \\ &= (\mathbf{e}_1 \vee \mathbf{e}_1) \dots (\mathbf{e}_N \vee \mathbf{e}_N) = \mathbf{e}_1^2 \dots \mathbf{e}_N^2, \end{aligned} \tag{27.32}$$

where we used Eq. (27.15). Using (27.32), together with (27.15) and (27.30), one can easily show that

$$\mathbf{e}_\Delta^2 \equiv \mathbf{e}_\Delta \vee \mathbf{e}_\Delta = (-1)^{N(N-1)/2} \lambda_\Delta \cdot \mathbf{1}. \tag{27.33}$$

Since $\lambda_\Delta \neq 0$, it follows that \mathbf{e}_Δ is invertible.

Equation (27.30) can be used to show that

$$\mathbf{e}_i \vee \mathbf{e}_\Delta = (-1)^{N-1} \mathbf{e}_\Delta \vee \mathbf{e}_i,$$

and since any vector in \mathcal{V} is a linear combination of the basis $\{\mathbf{e}_i\}_{i=1}^N$, the equation holds for arbitrary vectors. We thus have the following:

Theorem 27.2.8 *The canonical element \mathbf{e}_Δ satisfies the relations*

$$\begin{aligned} \mathbf{e}_\Delta \vee \mathbf{v} &= (-1)^{N-1} \mathbf{v} \vee \mathbf{e}_\Delta, \quad \mathbf{v} \in \mathcal{V}, \\ \mathbf{e}_\Delta \vee \mathbf{u} &= \omega_V^{N-1}(\mathbf{u}) \vee \mathbf{e}_\Delta, \quad \mathbf{u} \in \mathcal{C}_V, \end{aligned}$$

where ω_V is the degree involution of Definition 27.2.3. In particular, $\mathbf{e}_\Delta \vee \mathbf{u} = \mathbf{u} \vee \mathbf{e}_\Delta$ if N is odd, and $\mathbf{e}_\Delta \vee \mathbf{u} = \omega_V(\mathbf{u}) \vee \mathbf{e}_\Delta$ if N is even.

27.2.3 Center and Anticenter

Definition 27.2.9 The **center** of the Clifford algebra \mathcal{C}_V , denoted by \mathcal{Z}_V , consists of elements $\mathbf{a} \in \mathcal{C}_V$ satisfying

$$\mathbf{a} \vee \mathbf{u} = \mathbf{u} \vee \mathbf{a} \quad \forall \mathbf{u} \in \mathcal{C}_V.$$

The **anticenter** of the Clifford algebra \mathcal{C}_V , denoted by $\overline{\mathcal{Z}}_V$, consists of elements $\mathbf{a} \in \mathcal{C}_V$ satisfying

$$\mathbf{a} \vee \mathbf{u} = \omega_V(\mathbf{u}) \vee \mathbf{a} \quad \forall \mathbf{u} \in \mathcal{C}_V.$$

Since \mathcal{C}_V is generated by \mathcal{V} (i.e., it is sums of products of elements in \mathcal{V}), it follows that

$$\mathbf{a} \in \mathcal{Z}_V \quad \text{if and only if} \quad \mathbf{a} \vee \mathbf{x} = \mathbf{x} \vee \mathbf{a} \quad \forall \mathbf{x} \in \mathcal{V},$$

and

$$\mathbf{a} \in \overline{\mathcal{Z}}_V \quad \text{if and only if} \quad \mathbf{a} \vee \mathbf{x} = -\mathbf{x} \vee \mathbf{a} \quad \forall \mathbf{x} \in \mathcal{V}.$$

It is easy to show that \mathcal{Z}_V is a subalgebra of \mathcal{C}_V and that both \mathcal{Z}_V and $\overline{\mathcal{Z}}_V$ are invariant under the degree involution ω_V . Therefore, as in Eq. (27.17)

$$\begin{aligned} \mathcal{Z}_V &= \mathcal{Z}_V^0 \oplus_V \mathcal{Z}_V^1 \\ \overline{\mathcal{Z}}_V &= \overline{\mathcal{Z}}_V^0 \oplus_V \overline{\mathcal{Z}}_V^1 \end{aligned} \tag{27.34}$$

where \oplus_V indicates a direct sum of vector spaces.

Proposition 27.2.10 $\overline{\mathcal{Z}}_V^1 = 0$. That is, the anticenter of any Clifford algebra consists of even elements only.

Proof If $\mathbf{a} \in \overline{\mathcal{Z}}_V^1$, then $\mathbf{a} \vee \mathbf{x} = -\mathbf{x} \vee \mathbf{a}$ for any $\mathbf{x} \in \mathcal{V}$. Equation (27.30) then gives

$$\mathbf{a} \vee \mathbf{e}_\Delta = (-1)^N \mathbf{e}_\Delta \vee \mathbf{a}.$$

On the other hand, Theorem 27.2.8 and $\omega_V(\mathbf{a}) = -\mathbf{a}$ for $\mathbf{a} \in \overline{\mathcal{Z}}_V^1 = \mathcal{C}_V^1 \cap \overline{\mathcal{Z}}_V$ yields

$$\mathbf{e}_\Delta \vee \mathbf{a} = \omega_V^{N-1}(\mathbf{a}) \vee \mathbf{e}_\Delta = (-1)^{N-1} \mathbf{a} \vee \mathbf{e}_\Delta.$$

The last two equations, therefore, give $\mathbf{a} \vee \mathbf{e}_\Delta = 0$, and since \mathbf{e}_Δ is invertible, we have $\mathbf{a} = 0$. \square

Proposition 27.2.11 If \mathcal{V} is odd-dimensional, then $\mathbf{e}_\Delta \in \mathcal{Z}_V$, and if it is even-dimensional, then $\mathbf{e}_\Delta \in \overline{\mathcal{Z}}_V$.

Proof The proof follows immediately from Theorem 27.2.8. \square

Consider the linear map $\phi_V : \mathcal{C}_V \rightarrow \mathcal{C}_V$ given by

$$\phi_V(\mathbf{u}) = \mathbf{e}_\Delta \vee \mathbf{u}, \quad \mathbf{u} \in \mathcal{C}_V$$

and note that since \mathbf{e}_Δ is invertible, ϕ_V is a linear isomorphism. If N is odd, then Eq. (27.30) shows that $\phi_V : \mathcal{C}_V^0 \rightarrow \mathcal{C}_V^1$ and ϕ_V establishes an isomorphism of \mathcal{C}_V^0 and \mathcal{C}_V^1 . Now restrict the map to \mathcal{Z}_V . Then, using Theorem 27.2.8, for $\mathbf{x} \in \mathcal{V}$, we obtain

$$\begin{aligned} \phi_V(\mathbf{u}) \vee \mathbf{x} &= \mathbf{e}_\Delta \vee \mathbf{u} \vee \mathbf{x} = \mathbf{e}_\Delta \vee \mathbf{x} \vee \mathbf{u} \\ &= (-1)^{N-1} \mathbf{x} \vee \mathbf{e}_\Delta \vee \mathbf{u} = (-1)^{N-1} \mathbf{x} \vee \phi_V(\mathbf{u}). \end{aligned}$$

Similarly,

$$\phi_V(\mathbf{v}) \vee \mathbf{x} = (-1)^N \mathbf{x} \vee \phi_V(\mathbf{v}) \quad \mathbf{v} \in \overline{\mathcal{Z}}_V, \mathbf{x} \in \mathcal{V}.$$

We have just proved

Proposition 27.2.12 *If N is odd, then ϕ_V restricts to linear automorphisms of \mathcal{Z}_V and $\overline{\mathcal{Z}}_V$ and establishes an isomorphism between \mathcal{Z}_V^0 and \mathcal{Z}_V^1 . If N is even, then ϕ_V interchanges \mathcal{Z}_V and $\overline{\mathcal{Z}}_V$.*

Proposition 27.2.13 $\mathcal{Z}_V^0 = \text{Span}\{\mathbf{1}\}$.

Proof We use induction on the dimension of \mathcal{V} . For $N = 1$, the proposition is trivial. Assume that it holds for $N - 1$, and choose $\mathbf{v} \in \mathcal{V}$ such that $\langle \mathbf{v}, \mathbf{v} \rangle \neq 0$. With \mathcal{U} the orthogonal complement of \mathbf{v} , we can write

$$\mathcal{V} = \text{Span}\{\mathbf{v}\} \oplus \mathcal{U}$$

and note that (27.20) and (27.21) become

$$\begin{aligned} \mathcal{C}_V^0 &\cong (\mathbf{1} \hat{\otimes} \mathcal{C}_U^0) \oplus (\mathbf{v} \hat{\otimes} \mathcal{C}_U^1) \\ \mathcal{V} &\cong (\mathbf{1} \otimes \mathcal{U}) \oplus (\mathbf{v} \otimes \mathbf{1}). \end{aligned}$$

Identifying the left and right hand sides of these equations, we write

$$\begin{aligned} \mathbf{u} &= \mathbf{1} \otimes \mathbf{b} + \mathbf{v} \otimes \mathbf{c}, & \mathbf{u} &\in \mathcal{C}_V^0, \mathbf{b} \in \mathcal{C}_U^0, \mathbf{c} \in \mathcal{C}_U^1 \\ \mathbf{x} &= \mathbf{1} \otimes \mathbf{y} + \mathbf{v} \otimes \mathbf{1}, & \mathbf{x} &\in \mathcal{V}, \mathbf{y} \in \mathcal{U}. \end{aligned}$$

We now use the multiplication rule of Eq. (26.24), noting that $\mathbf{1}$ and \mathbf{b} have even degrees while \mathbf{v} , \mathbf{y} , and \mathbf{c} have odd degrees:

$$\begin{aligned} \mathbf{u} \vee \mathbf{x} &= (\mathbf{1} \otimes \mathbf{b} + \mathbf{v} \otimes \mathbf{c}) \odot (\mathbf{1} \otimes \mathbf{y} + \mathbf{v} \otimes \mathbf{1}) \\ &= (\mathbf{1} \otimes \mathbf{b}) \odot (\mathbf{1} \otimes \mathbf{y}) + (\mathbf{1} \otimes \mathbf{b}) \odot (\mathbf{v} \otimes \mathbf{1}) \\ &\quad + (\mathbf{v} \otimes \mathbf{c}) \odot (\mathbf{1} \otimes \mathbf{y}) + (\mathbf{v} \otimes \mathbf{c}) \odot (\mathbf{v} \otimes \mathbf{1}) \\ &= \mathbf{1} \otimes (\mathbf{b} \vee \mathbf{y}) + \mathbf{v} \otimes \mathbf{b} + \mathbf{v} \otimes (\mathbf{c} \vee \mathbf{y}) - (\mathbf{v} \vee \mathbf{v}) \otimes \mathbf{c}. \end{aligned}$$

Similarly,

$$\mathbf{x} \vee \mathbf{u} = \mathbf{1} \otimes (\mathbf{y} \vee \mathbf{b}) + \mathbf{v} \otimes \mathbf{b} - \mathbf{v} \otimes (\mathbf{y} \vee \mathbf{c}) + (\mathbf{v} \vee \mathbf{v}) \otimes \mathbf{c}.$$

Now assume that \mathbf{u} is in the center of the Clifford algebra. Then the two equations above are equal, and noting that $\mathbf{v} \vee \mathbf{v} = \langle \mathbf{v}, \mathbf{v} \rangle \mathbf{1}$, we obtain

$$\mathbf{1} \otimes (\mathbf{b} \vee \mathbf{y} - \mathbf{y} \vee \mathbf{b} - 2\langle \mathbf{v}, \mathbf{v} \rangle \mathbf{c}) + \mathbf{v} \otimes (\mathbf{c} \vee \mathbf{y} + \mathbf{y} \vee \mathbf{c}) = 0,$$

or

$$\begin{aligned} \mathbf{b} \vee \mathbf{y} - \mathbf{y} \vee \mathbf{b} - 2\langle \mathbf{v}, \mathbf{v} \rangle \mathbf{c} &= 0 \\ \mathbf{c} \vee \mathbf{y} + \mathbf{y} \vee \mathbf{c} &= 0. \end{aligned} \tag{27.35}$$

The second equation implies that $\mathbf{c} \in \overline{\mathcal{Z}}_U$ and hence $\mathbf{c} \in \overline{\mathcal{Z}}_U^1$. Then by Proposition 27.2.10, $\mathbf{c} = 0$. The first relation in (27.35) now implies that $\mathbf{b} \in \mathcal{Z}_U$ and therefore $\mathbf{b} \in \mathcal{Z}_U^0$. By induction assumption, \mathbf{b} is a multiple of the identity in \mathcal{C}_U . Thus,

$$\mathbf{u} = \mathbf{1} \otimes (\alpha \mathbf{1}_U) + \mathbf{v} \otimes \mathbf{0} = \alpha \mathbf{1},$$

i.e., $\mathbf{u} \in \text{Span}\{\mathbf{1}\}$. □

Theorem 27.2.14 *Let \mathcal{V} be an N -dimensional space. Then*

- (a) *If N is odd, $\mathcal{Z}_V = \text{Span}\{\mathbf{1}, \mathbf{e}_\Delta\}$, $\overline{\mathcal{Z}}_V = 0$.*
- (b) *If N is even, $\mathcal{Z}_V = \text{Span}\{\mathbf{1}\}$, $\overline{\mathcal{Z}}_V = \text{Span}\{\mathbf{e}_\Delta\}$. Thus all Clifford algebras over an even-dimensional vector space are central.*

Proof Suppose that N is odd and $\mathbf{a} \in \overline{\mathcal{Z}}_V$. Then, $\mathbf{a} \vee \mathbf{x} = -\mathbf{x} \vee \mathbf{a}$, for any $\mathbf{x} \in \mathcal{V}$. Equation (27.30) then yields $\mathbf{a} \vee \mathbf{e}_\Delta = -\mathbf{e}_\Delta \vee \mathbf{a}$. On the other hand, the second equation of Theorem 27.2.8 implies that $\mathbf{a} \vee \mathbf{e}_\Delta = \mathbf{e}_\Delta \vee \mathbf{a}$. Hence, $\mathbf{a} \vee \mathbf{e}_\Delta = 0$, and since \mathbf{e}_Δ is invertible, we have $\mathbf{a} = 0$. This proves the second part of (a).

Next observe that by Proposition 27.2.13 $\mathcal{Z}_V^0 = \text{Span}\{\mathbf{1}\}$ and that, since N is assumed odd, by Proposition 27.2.12, ϕ_V is an automorphism of \mathcal{Z}_V and an isomorphism between \mathcal{Z}_V^0 and \mathcal{Z}_V^1 . Since $\mathcal{Z}_V^0 = \text{Span}\{\mathbf{1}\}$ and $\phi_V(\mathbf{1}) = \mathbf{e}_\Delta$, we must have $\mathcal{Z}_V^1 = \text{Span}\{\mathbf{e}_\Delta\}$.

Now consider the case when N is even. For $\mathbf{a} \in \mathcal{Z}_V$, we have $\mathbf{a} \vee \mathbf{e}_\Delta = \mathbf{e}_\Delta \vee \mathbf{a}$. On the other hand, by Theorem 27.2.8, $\mathbf{a} \vee \mathbf{e}_\Delta = \omega_V(\mathbf{a}) \vee \mathbf{e}_\Delta$. Since \mathbf{e}_Δ is invertible, we have $\omega_V(\mathbf{a}) = \mathbf{a}$ or $(\omega_V - \iota)\mathbf{a} = 0$. Therefore, by Eq. (27.18), $\mathbf{a} \in \mathcal{Z}_V^0$ and hence $\mathcal{Z}_V = \mathcal{Z}_V^0$. Proposition 27.2.13 now gives $\mathcal{Z}_V = \text{Span}\{\mathbf{1}\}$.

Since ϕ_V interchanges \mathcal{Z}_V and $\overline{\mathcal{Z}}_V$, we have

$$\overline{\mathcal{Z}}_V = \phi_V(\mathcal{Z}_V) = \phi_V(\text{Span}\{\mathbf{1}\}) = \text{Span}\{\phi_V(\mathbf{1})\} = \text{Span}\{\mathbf{e}_\Delta\}.$$

This completes the proof. □

27.2.4 Isomorphisms

Let $(\mathcal{V}, \mathbf{g})$ be an inner product space. If we change the sign of the inner product, we get another inner product space $\tilde{\mathcal{V}} \equiv (\mathcal{V}, -\mathbf{g})$. Next consider two vector spaces \mathcal{V} and \mathcal{U} , and suppose that Δ can be chosen in such a

way that the canonical element of \mathcal{C}_V satisfies $\mathbf{e}_\Delta^2 = \pm \mathbf{1}$. Then we have the following two theorems whose proof can be found in [Greu 78, pp. 244–245]:

Theorem 27.2.15 *Let $\dim \mathcal{V} = 2m$, and assume that Δ can be chosen such that $\lambda_\Delta = (-1)^m$. Then the Clifford algebras \mathcal{C}_V and $\mathcal{C}_{\tilde{V}}$ are isomorphic.*

Theorem 27.2.16 *Let \mathcal{V} be an even-dimensional inner product space and \mathcal{U} any other inner product space. Then*

$$\begin{aligned} \mathcal{C}_{V \oplus U} &\cong \mathcal{C}_V \otimes \mathcal{C}_U && \text{if } \mathbf{e}_\Delta^2 = \mathbf{1} \\ \mathcal{C}_{V \oplus \tilde{U}} &\cong \mathcal{C}_V \otimes \mathcal{C}_U && \text{if } \mathbf{e}_\Delta^2 = -\mathbf{1}. \end{aligned}$$

Another theorem, which will be useful in the classification of Clifford algebras and whose proof is given in [Greu 78, p. 248], is the following.

Theorem 27.2.17 *Let \mathcal{V} be an even-dimensional inner product space. Assume that \mathcal{V} has an antisymmetric involution ω (so that $\omega^t = -\omega$). Then the Clifford algebra \mathcal{C}_V is isomorphic to $\mathcal{L}(\Lambda(\mathcal{V}_1))$, the set of linear transformation of $\Lambda(\mathcal{V}_1)$ where $\mathcal{V}_1 = \ker(\omega - \iota)$.*

Recall from Theorem 26.3.6 that $\dim \Lambda(\mathcal{V}_1) = 2^{\dim \mathcal{V}_1}$, and that all real vector spaces of dimension N are isomorphic to \mathbb{R}^N . Therefore, we can identify $\mathcal{L}(\Lambda(\mathcal{V}_1))$ with $\mathcal{L}(\mathbb{R}^{2^{\dim \mathcal{V}_1}})$, and obtain the algebra isomorphism

$$\mathcal{C}_V \cong \mathcal{L}(\mathbb{R}^{2^{\dim \mathcal{V}_1}}) \tag{27.36}$$

for \mathcal{V} of the theorem above.

27.3 General Classification of Clifford Algebras

In almost all our preceding discussion, we have assumed that our scalars come from \mathbb{R} . There is a good reason for that: the complex Clifford algebras are very limited and applications in physics almost exclusively focus on real Clifford algebras. In this subsection, we include complex numbers as our scalars and classify all complex Clifford algebras.

Definition 27.3.1 Let \mathbb{F} denote either \mathbb{C} or \mathbb{R} and let \mathcal{V} be a vector space over \mathbb{F} . Choose a basis $\{\mathbf{e}_i\}_{i=1}^n$ for \mathcal{V} and let $\mathbf{v} = \sum_{i=1}^n \eta_i \mathbf{e}_i$ be a vector in \mathcal{V} . A **quadratic form** of index ν on \mathcal{V} is a map $\mathbf{Q}_\nu : \mathcal{V} \rightarrow \mathbb{F}$ given by

$$\mathbf{Q}_\nu(\mathbf{v}) = - \sum_{i=1}^{\nu} \eta_i^2 + \sum_{i=\nu+1}^n \eta_i^2. \tag{27.37}$$

A quadratic form yields an inner product.² In fact, defining

$$2\mathbf{g}(\mathbf{u}, \mathbf{v}) = \mathbf{Q}_\nu(\mathbf{u} + \mathbf{v}, \mathbf{u} + \mathbf{v}) - \mathbf{Q}_\nu(\mathbf{u}, \mathbf{u}) - \mathbf{Q}_\nu(\mathbf{v}, \mathbf{v}),$$

it is easy to verify that \mathbf{g} is indeed a symmetric bilinear map. Conversely, given an inner product \mathbf{g} of index ν , one can construct a quadratic form: $\mathbf{Q}_\nu(\mathbf{v}) = \mathbf{g}(\mathbf{v}, \mathbf{v})$. It turns out that the basis vectors chosen to define the quadratic form are automatically \mathbf{g} -orthonormal.

When $\mathbb{F} = \mathbb{C}$, there is only one kind of quadratic form: that with $\nu = 0$. This is because one can always change η_k to $i\eta_k$ to turn all the negative terms in the sum to positive terms. However, when $\mathbb{F} = \mathbb{R}$, we obtain different quadratic forms depending on the index ν . Thus, the real quadratic form leads to the inner product of \mathbb{R}^n introduced in Eq. (26.40) and the corresponding Clifford algebra will be discussed in detail in the next section.

Before we classify the easy case of complex Clifford algebras, let us observe some general properties of the Clifford algebra over \mathbb{F} , which we denote by $\mathcal{C}_V(\mathbb{F})$. First, we note that since $\mathbf{e}_i^2 \equiv \mathbf{e}_i \vee \mathbf{e}_i = \mathbf{g}(\mathbf{e}_i, \mathbf{e}_i)\mathbf{1}$, $\mathbf{e}_i^k \neq \mathbf{0}$ for any positive integer k . Therefore, $\mathcal{C}_V(\mathbb{F})$ cannot contain a radical for any \mathcal{V} over \mathbb{F} . This means that $\mathcal{C}_V(\mathbb{F})$ is semi-simple. Moreover, Theorem 27.2.14 implies that $\mathcal{C}_V(\mathbb{F})$ is simple if \mathcal{V} is even-dimensional.

Next, we look at the case of odd-dimensional vector spaces which is only slightly more complicated. In this case $\mathcal{Z}_V = \text{Span}\{\mathbf{1}, \mathbf{e}_\Delta\}$ by Theorem 27.2.14, and as we shall see presently, \mathbf{e}_Δ^2 plays a significant role in the classification of $\mathcal{C}_V(\mathbb{F})$ when $\dim \mathcal{V}$ is odd. Equation (27.33) gives \mathbf{e}_Δ^2 in terms of λ_Δ of Eq. (27.32). If $\mathbb{F} = \mathbb{C}$, then we can choose $\mathbf{g}(\mathbf{e}_i, \mathbf{e}_i) = 1$. In fact, for any non-null vector $\mathbf{v} \in \mathcal{V}$, we have

$$\mathbf{g}(\mathbf{e}_\nu, \mathbf{e}_\nu) \equiv \mathbf{g}\left(\frac{\mathbf{v}}{\sqrt{\mathbf{g}(\mathbf{v}, \mathbf{v})}}, \frac{\mathbf{v}}{\sqrt{\mathbf{g}(\mathbf{v}, \mathbf{v})}}\right) = 1.$$

Hence, we can always set $\lambda_\Delta = 1$ when $\mathbb{F} = \mathbb{C}$. We can't do this for the real case because $\sqrt{\mathbf{g}(\mathbf{v}, \mathbf{v})}$ may be pure imaginary.

If $\mathbb{F} = \mathbb{R}$, then because of the Lagrange identities (26.42) and (27.31), $\lambda_\Delta = (-1)^\nu$ and the canonical element satisfies the relation

$$\mathbf{e}_\Delta^2 = (-1)^{N(N-1)/2+\nu}\mathbf{1}. \tag{27.38}$$

Thus $\mathbf{e}_\Delta^2 = \pm\mathbf{1}$ depending on the index ν and dimension N of \mathcal{V} .

We discuss the case of $\mathbf{e}_\Delta^2 = +\mathbf{1}$ first. The elements $\mathbf{P}_\pm = \frac{1}{2}(\mathbf{1} \pm \mathbf{e}_\Delta)$ are two orthogonal idempotents belonging to the center of $\mathcal{C}_V(\mathbb{F})$. Since $\mathbf{P}_+ + \mathbf{P}_- = \mathbf{1}$, we have the decomposition

$$\mathcal{C}_V(\mathbb{F}) = \mathcal{C}_V^+(\mathbb{F}) \oplus \mathcal{C}_V^-(\mathbb{F}) \equiv \mathbf{P}_+\mathcal{C}_V(\mathbb{F}) \oplus \mathbf{P}_-\mathcal{C}_V(\mathbb{F}), \tag{27.39}$$

where $\mathcal{C}_V^+(\mathbb{F})$ and $\mathcal{C}_V^-(\mathbb{F})$ are subalgebras (actually ideals) of $\mathcal{C}_V(\mathbb{F})$.

²Here we define an inner product simply as a symmetric bilinear map as in Definition 2.4.2.

Since \mathbf{e}_Δ is the product of an odd number of vectors, $\omega_V(\mathbf{e}_\Delta) = -\mathbf{e}_\Delta$. Hence, $\omega_V(\mathbf{P}_\pm) = \mathbf{P}_\mp$. Furthermore, ω_V , being an involution, has an inverse. Thus, it is an isomorphism of $\mathcal{C}_V^+(\mathbb{F})$ and $\mathcal{C}_V^-(\mathbb{F})$.

We now show that $\mathcal{C}_V^\pm(\mathbb{F})$ are central. We do this for $\mathcal{C}_V^+(\mathbb{F})$, with the other case following immediately from the proof of $\mathcal{C}_V^-(\mathbb{F})$. Let $\mathbf{a}_+ \in \mathcal{Z}_V^+(\mathbb{F})$, the center of $\mathcal{C}_V^+(\mathbb{F})$, and $\mathbf{b} \in \mathcal{C}_V(\mathbb{F})$. Then

$$\mathbf{a}_+ \mathbf{b} = \mathbf{a}_+ (\mathbf{b}_+ + \mathbf{b}_-) = \mathbf{a}_+ \mathbf{b}_+ + \mathbf{a}_+ \mathbf{b}_- = \mathbf{a}_+ \mathbf{b}_+ = \mathbf{b}_+ \mathbf{a}_+ = \mathbf{b} \mathbf{a}_+$$

because $\mathbf{0} = \mathbf{a}_+ \mathbf{b}_- = \mathbf{b}_- \mathbf{a}_+$. It follows that $\mathbf{a}_+ \in \mathcal{Z}_V(\mathbb{F})$. Therefore,

$$\mathbf{a}_+ = \alpha \mathbf{1} + \beta \mathbf{e}_\Delta = \alpha(\mathbf{P}_+ + \mathbf{P}_-) + \beta(\mathbf{P}_+ - \mathbf{P}_-) = (\alpha + \beta)\mathbf{P}_+ + (\alpha - \beta)\mathbf{P}_-.$$

Since \mathbf{a}_+ has no component in \mathbf{P}_- , we must have $\alpha = \beta$ and $\mathbf{a}_+ = 2\alpha\mathbf{P}_+$. Hence, $\mathbf{a}_+ \in \text{Span}\{\mathbf{P}_+\}$. But \mathbf{P}_+ is the identity of $\mathcal{C}_V^+(\mathbb{F})$. It now follows that $\mathcal{C}_V^+(\mathbb{F})$ is central simple. Similarly, $\mathcal{C}_V^-(\mathbb{F})$ is central simple. We summarize the foregoing discussion as follows:

Theorem 27.3.2 *Let \mathbb{F} be either \mathbb{C} or \mathbb{R} and \mathcal{V} a vector space over \mathbb{F} .*

- (a) *If $\dim \mathcal{V}$ is even, then $\mathcal{C}_V(\mathbb{F})$ is central simple.*
- (b) *If $\dim \mathcal{V}$ is odd, then $\mathcal{C}_V(\mathbb{C})$ is the direct sum of two isomorphic central simple Clifford algebras. $\mathcal{C}_V(\mathbb{R})$ is the direct sum of two isomorphic central simple Clifford algebras if $\mathbf{e}_\Delta^2 = +\mathbf{1}$.*

We are now ready to classify all complex Clifford algebras. All we have to do is to use Theorem 3.5.29:

Theorem 27.3.3 *A complex Clifford algebra $\mathcal{C}_V(\mathbb{C})$ is isomorphic to either a total complex matrix algebra or a direct sum of two such algebras:*

- (a) $\mathcal{C}_V(\mathbb{C}) \cong \mathcal{M}_r(\mathbb{C})$ for some positive integer r , if $\dim \mathcal{V}$ is even.
- (b) $\mathcal{C}_V(\mathbb{C}) \cong \mathcal{M}_s(\mathbb{C}) \oplus \mathcal{M}_s(\mathbb{C})$ for some positive integer s , if $\dim \mathcal{V}$ is odd.

Although the real Clifford algebras are classified in the next section in much more detail, it is instructive to give a classification of $\mathcal{C}_V(\mathbb{R})$ based on what we know from our study of algebras in general. If \mathcal{V} is even-dimensional, $\mathcal{C}_V(\mathbb{R})$ is central simple, and by Theorem 3.5.30, it is of the form $\mathcal{D} \otimes \mathcal{M}_n$ where \mathcal{D} is \mathbb{R} or \mathbb{H} .

If \mathcal{V} is odd-dimensional, then we have to consider two cases. If $\mathbf{e}_\Delta^2 = +\mathbf{1}$, then $\mathcal{C}_V(\mathbb{R})$ is the direct sum of two central algebras and thus isomorphic to

$$\mathbb{R} \otimes \mathcal{M}_r \cong \mathcal{M}_r(\mathbb{R}) \quad \text{or to} \quad \mathbb{H} \otimes \mathcal{M}_s \cong \mathcal{M}_s(\mathbb{H}) \cong \mathbb{H} \otimes \mathcal{M}_s(\mathbb{R}),$$

for some nonnegative integers r and s . If $\mathbf{e}_\Delta^2 = -\mathbf{1}$, then the center of $\mathcal{C}_V(\mathbb{R})$, which is $\text{Span}\{\mathbf{1}, \mathbf{e}_\Delta\}$, is isomorphic to \mathbb{C} , and again by Theorem 3.5.30, $\mathcal{C}_V(\mathbb{R})$ is isomorphic to

$$\mathbb{C} \otimes \mathcal{M}_p \cong \mathcal{M}_p(\mathbb{C}) \quad \text{or to} \quad \mathbb{C} \otimes \mathbb{H} \otimes \mathcal{M}_q \cong \mathbb{H} \otimes \mathcal{M}_q(\mathbb{C}),$$

for some nonnegative integers p and q .
 We summarize this discussion in

Theorem 27.3.4 *A real Clifford algebra $\mathcal{C}_V(\mathbb{R})$ is classified as follows:*

- (a) *If \mathcal{V} is even-dimensional, then $\mathcal{C}_V(\mathbb{R}) \cong \mathcal{D} \otimes \mathcal{M}_r \cong \mathcal{M}_r(\mathcal{D})$, where r is a positive integer and $\mathcal{D} = \mathbb{R}$ or \mathbb{H} , i.e., $\mathcal{C}_V(\mathbb{R})$ is a total matrix algebra over reals or quaternions.*
- (b) *If \mathcal{V} is odd-dimensional, then we have to consider two cases:*
 - 1. *If $\mathbf{e}_\Delta^2 = -\mathbf{1}$, then $\mathcal{C}_V(\mathbb{R}) \cong \mathcal{M}_s(\mathcal{D})$, where s is a positive integer and \mathcal{D} is either \mathbb{C} or $\mathbb{C} \otimes \mathbb{H}$.*
 - 2. *If $\mathbf{e}_\Delta^2 = \mathbf{1}$, then $\mathcal{C}_V(\mathbb{R}) \cong \mathcal{M}_p(\mathcal{D}) \oplus \mathcal{M}_p(\mathcal{D})$, where p is a positive integer and \mathcal{D} is either \mathbb{R} or \mathbb{H} .*

27.4 The Clifford Algebras $\mathbf{C}_\mu^v(\mathbb{R})$

Our discussion of inner products in Sect. 26.5 showed that orthonormal bases are especially convenient. In such bases, the metric matrix $g_{ij} \equiv \eta_{ij}$ is diagonal, with $\eta_{ii} = \pm 1$. In fact, if v is the index of \mathcal{V} (see Theorem 26.5.21), then, introducing $\mu \equiv N - v$, we have

$$g_{ij} = \eta_{ij} = \begin{cases} 0 & \text{if } i \neq j, \\ +1 & \text{if } 1 \leq i \leq \mu, \\ -1 & \text{if } \mu + 1 \leq i \leq N, \end{cases} \tag{27.40}$$

and Eq. (27.15) becomes

$$\begin{aligned} \mathbf{e}_i \vee \mathbf{e}_j &= -\mathbf{e}_j \vee \mathbf{e}_i & \text{if } i \neq j, \\ \mathbf{e}_i \vee \mathbf{e}_i &= +1 & \text{if } 1 \leq i \leq \mu, \\ \mathbf{e}_i \vee \mathbf{e}_i &= -1 & \text{if } \mu + 1 \leq i \leq N. \end{aligned} \tag{27.41}$$

The Clifford algebra $\mathbf{C}_\mu^v(\mathbb{R})$ The Clifford algebra determined by (27.41) is denoted by $\mathbf{C}_\mu^v(\mathbb{R})$.³ It is the Clifford algebra of the vector space \mathbb{R}_μ^v introduced on page 815.

Example 27.4.1 The simplest $\mathbf{C}_\mu^v(\mathbb{R})$ is when one of the subscripts is 0 and the other 1. First let $\mu = 0$ and $v = 1$. In this case, \mathcal{V} is one-dimensional. Let \mathbf{e} be the basis vector of \mathcal{V} . Then a basis of the Clifford algebra $\mathbf{C}_0^1(\mathbb{R})$ is $\{\mathbf{1}, \mathbf{e}\}$, and an arbitrary element of $\mathbf{C}_0^1(\mathbb{R})$ can be written as $\alpha\mathbf{1} + \beta\mathbf{e}$. The multiplication of any two such elements is completely determined by the multiplication of the basis vectors:

$$\mathbf{1} \vee \mathbf{1} = \mathbf{1}, \quad \mathbf{1} \vee \mathbf{e} = \mathbf{e} \vee \mathbf{1} = \mathbf{e}, \quad \mathbf{e} \vee \mathbf{e} = -\mathbf{1}.$$

³Many other notations are also used to denote this algebra. Among them are $\mathbf{C}_{\mu,v}(\mathbb{R})$, $\mathbf{C}(\mu, v)$, $\mathcal{C}\ell_{\mu,v}(\mathbb{R})$, $\mathcal{C}\ell_{p,q}(\mathbb{R})$, and $\mathbf{C}(p, q)$ where $q = v$ and $p = \mu$. Occasionally, we'll use one of these notations as well.

If we identify \mathbf{e} with $i = \sqrt{-1}$ and \vee with ordinary multiplication, then $C_0^1(\mathbb{R})$ becomes identical with the (algebra of) complex numbers. Thus, $C_0^1(\mathbb{R}) \cong \mathbb{C}$.

$$C_0^1(\mathbb{R}) \cong \mathbb{C}$$

Now let $\mu = 1$ and $\nu = 0$. Again, \mathcal{V} is one-dimensional with \mathbf{e} as its basis vector. The basis of the Clifford algebra $C_1^0(\mathbb{R})$ is again $\{\mathbf{1}, \mathbf{e}\}$. The multiplication of the basis vectors gives

$$\mathbf{1} \vee \mathbf{1} = \mathbf{1}, \quad \mathbf{1} \vee \mathbf{e} = \mathbf{e} \vee \mathbf{1} = \mathbf{e}, \quad \mathbf{e} \vee \mathbf{e} = \mathbf{1}.$$

This shows that $\mathbf{1}$ and \mathbf{e} have identical properties, and since $\mathbf{1}$ is a basis of \mathbb{R} , so must be \mathbf{e} . We conclude that $C_1^0(\mathbb{R}) \cong \mathbb{R} \oplus \mathbb{R}$. As a direct sum of two algebras, $\mathbb{R} \oplus \mathbb{R}$ has the product rule,

$$C_1^0(\mathbb{R}) \cong \mathbb{R} \oplus \mathbb{R}$$

$$(\alpha_1 \oplus \alpha_2)(\beta_1 \oplus \beta_2) = (\alpha_1\beta_1 \oplus \alpha_2\beta_2).$$

In analogy with the ordinary complex numbers, $\mathbb{R} \oplus \mathbb{R}$ with this multiplication rule is called **split complex numbers**. Problem 27.6 establishes a concrete algebra isomorphism between C_1^0 and $\mathbb{R} \oplus \mathbb{R}$.

split complex numbers

Example 27.4.2 In this example, we consider a slightly more complicated Clifford algebra than Example 27.4.1, namely $C_0^2(\mathbb{R})$. Let \mathbf{e}_1 and \mathbf{e}_2 be the two orthonormal basis vectors of the two-dimensional vector space \mathcal{V} on which the Clifford algebra $C_0^2(\mathbb{R})$ is defined. This algebra is 4-dimensional with a basis $\{\mathbf{1}, \mathbf{e}_1, \mathbf{e}_2, \mathbf{e}_1 \vee \mathbf{e}_2\}$. To make the multiplication of the basis vectors more transparent, let's set $\mathbf{e}_1 = \mathbf{a}$, $\mathbf{e}_2 = \mathbf{b}$, $\mathbf{e}_1 \vee \mathbf{e}_2 = \mathbf{c}$. Then it is clear that

$$\begin{aligned} \mathbf{a} \vee \mathbf{a} &= -\mathbf{1}, & \mathbf{a} \vee \mathbf{b} &= \mathbf{c}, & \mathbf{a} \vee \mathbf{c} &= -\mathbf{b} \\ \mathbf{b} \vee \mathbf{a} &= -\mathbf{c}, & \mathbf{b} \vee \mathbf{b} &= -\mathbf{1}, & \mathbf{b} \vee \mathbf{c} &= \mathbf{a} \\ \mathbf{c} \vee \mathbf{a} &= \mathbf{b}, & \mathbf{c} \vee \mathbf{b} &= -\mathbf{a}, & \mathbf{c} \vee \mathbf{c} &= -\mathbf{1}. \end{aligned} \tag{27.42}$$

Most of these are self-evident. The less obvious ones can be easily shown using Eq. (27.41). For example,

$$\mathbf{c} \vee \mathbf{c} = \mathbf{e}_1 \vee \underbrace{\mathbf{e}_2 \vee \mathbf{e}_1}_{=-\mathbf{e}_1 \vee \mathbf{e}_2} \vee \mathbf{e}_2 = -\underbrace{\mathbf{e}_1 \vee \mathbf{e}_1}_{=-\mathbf{1}} \vee \underbrace{\mathbf{e}_2 \vee \mathbf{e}_2}_{=-\mathbf{1}} = -\mathbf{1}.$$

Comparison of Eq. (27.42) with Example 3.1.16 reveals that $C_0^2(\mathbb{R})$ is the algebra of quaternions: $C_0^2(\mathbb{R}) \cong \mathbb{H}$.

$$C_0^2(\mathbb{R}) \cong \mathbb{H}$$

The two examples above identified some low-dimensional Clifford algebras of the type $C_\mu^\nu(\mathbb{R})$ with certain familiar algebras. It is possible to identify all $C_\mu^\nu(\mathbb{R})$ with more familiar algebras as we proceed to show in the following. We first need to establish some isomorphisms among the algebras $C_\mu^\nu(\mathbb{R})$ themselves.

Set $N = 2$ in Eq. (27.38) to get $\mathbf{e}_\Delta^2 = (-1)^{1+\nu} \mathbf{1}$. In particular, for $\nu = 0$ and $\nu = 2$, we get $\mathbf{e}_\Delta^2 = -\mathbf{1}$ for both $C_2^0(\mathbb{R})$ and $C_0^2(\mathbb{R})$. Now in Theorem 27.2.16, let $\mathcal{U} = \mathbb{R}_{n-\nu}^n$ and $\mathcal{V} = \mathbb{R}_2^2$ (recall that \mathcal{V} has to be even-dimensional) and note that $\mathcal{U} = \mathbb{R}_\nu^n$. The second identity of that theorem

then gives

$$C_{\mathbb{R}_2^2 \oplus \mathbb{R}_v^n} \cong C_{\mathbb{R}_2^2} \otimes C_{\mathbb{R}_{n-v}^n} \equiv C_0^2(\mathbb{R}) \otimes C_\nu^\mu(\mathbb{R}). \quad (27.43)$$

Note the position of μ and ν in the last term! Also note that since $\mathbb{R}_2^2 \oplus \mathbb{R}_\nu^n = \mathbb{R}_\nu^n \oplus \mathbb{R}_2^2$, we must have $C_0^2(\mathbb{R}) \otimes C_\nu^\mu(\mathbb{R}) = C_\nu^{\mu+2}(\mathbb{R}) \otimes C_0^2(\mathbb{R})$. But $\mathbb{R}_2^2 \oplus \mathbb{R}_\nu^n = \mathbb{R}_{\nu+2}^{\mu+2}$ by Proposition 26.5.23. Hence, the left-hand side of the equation above is simply $C_{\nu+2}^{\mu+2}(\mathbb{R})$. By choosing $\mathcal{U} = \mathbb{R}_0^2$, and going through the same procedure we obtain a similar result. The following theorem, in which we have restored μ and ν to their normal position on the right-hand side of (27.43) (now written on the left in the following theorem), summarizes these results.

Theorem 27.4.3 *There exist the following Clifford algebra isomorphisms:*

$$\begin{aligned} C_\mu^\nu(\mathbb{R}) \otimes C_0^2(\mathbb{R}) &\cong C_{\nu+2}^{\mu+2}(\mathbb{R}) \\ C_\mu^\nu(\mathbb{R}) \otimes C_2^0(\mathbb{R}) &\cong C_{\nu+2}^\mu(\mathbb{R}) \end{aligned}$$

Theorem 27.4.4 *Suppose that $\mu = \nu + 4k$ for some integer k . Then*

$$C_\mu^\nu(\mathbb{R}) \cong C_\nu^\mu(\mathbb{R})$$

Proof We note that $N = \mu + \nu = 2\nu + 4k = 2(\nu + 2k) \equiv 2m$. Therefore, if Δ is the normed determinant function, then

$$\lambda_\Delta = (-1)^\nu = (-1)^{m-2k} = (-1)^m.$$

Now apply Theorem 27.2.15, noting that $\widetilde{\mathbb{R}}_\nu^n = \mathbb{R}_\mu^n$. □

For the special case of $\nu = 0$, we obtain

$$C_\mu^0(\mathbb{R}) \cong C_0^\mu(\mathbb{R}) \quad \text{if } N = 4k. \quad (27.44)$$

The case of $\mu = \nu$ is important in the classification of the Clifford algebras. In this case, we can write

$$\mathbb{R}_\nu^n = \mathbb{R}_\nu^{2\nu} = \mathbb{R}_\mu^{2\mu} = \mathbb{R}_0^\mu \oplus \mathbb{R}_\mu^\mu, \quad (27.45)$$

where the inner product is positive definite in the first subspace and negative definite in the second. Let $\{\hat{\mathbf{e}}_i\}_{i=1}^\mu$ and $\{\hat{\mathbf{f}}_i\}_{i=1}^\mu$ be orthonormal bases of \mathbb{R}_0^μ and \mathbb{R}_μ^μ , respectively, so that

$$\langle \hat{\mathbf{e}}_i, \hat{\mathbf{e}}_j \rangle = \delta_{ij}, \quad \langle \hat{\mathbf{f}}_i, \hat{\mathbf{f}}_j \rangle = -\delta_{ij}, \quad i, j = 1, 2, \dots, \mu.$$

Now define an involution ω on \mathbb{R}_ν^n as follows:

$$\omega(\hat{\mathbf{e}}_i) = \hat{\mathbf{f}}_i, \quad \text{and} \quad \omega(\hat{\mathbf{f}}_i) = \hat{\mathbf{e}}_i, \quad i = 1, 2, \dots, \mu. \quad (27.46)$$

Then it can easily be shown that $\omega^t = -\omega$ (see Problem 27.12). Hence, by Theorem 27.2.17 and Eq. (27.36), $C_\mu^\mu(\mathbb{R}) = \mathcal{L}(\mathbb{R}^{2^{\dim \mathcal{V}_1}})$, where $\mathcal{V}_1 = \ker(\omega - \iota)$. But

$$\mathbf{u} = \sum_{i=1}^{\mu} (\alpha_i \hat{\mathbf{e}}_i + \beta_i \hat{\mathbf{f}}_i) \in \ker(\omega - \iota) \iff \alpha_i = \beta_i$$

as can be readily shown. This yields $\mathcal{V}_1 = \text{Span}\{\hat{\mathbf{e}}_i + \hat{\mathbf{f}}_i\}_{i=1}^{\mu}$. Therefore, $\dim \mathcal{V}_1 = \mu$, and (27.36) gives the isomorphism

$$C_\mu^\mu(\mathbb{R}) \cong \mathcal{L}(\mathbb{R}^{2^\mu}). \tag{27.47}$$

Example 27.4.5 For the simplest case of $\mu = 1$, we have $C_1^1(\mathbb{R}) \cong \mathcal{L}(\mathbb{R}^2) \cong \mathcal{M}^{2 \times 2}$. The isomorphism can be established directly by a procedure similar to Example 27.2.6.

For the case of $\mu = 2$, we have $C_2^2(\mathbb{R}) \cong \mathcal{L}(\mathbb{R}^4) \cong \mathcal{M}^{4 \times 4}$. Furthermore, setting $\mu = 2$ and $\nu = 0$ in the second equation of Theorem 27.4.3, we obtain

$$C_2^2(\mathbb{R}) \cong C_2^0(\mathbb{R}) \otimes C_2^0(\mathbb{R}) \cong \mathbb{H} \otimes \mathbb{H}$$

where we used the result of Example 27.4.2. Hence, we have the isomorphisms

$$C_2^2(\mathbb{R}) \cong \mathcal{L}(\mathbb{R}^4) \cong \mathcal{M}^{4 \times 4} \cong \mathbb{H} \otimes \mathbb{H}. \tag{27.48}$$

Problem 27.14 gives a direct isomorphic map from $\mathbb{H} \otimes \mathbb{H}$ to $\mathcal{L}(\mathbb{R}^4)$.

27.4.1 Classification of $C_n^0(\mathbb{R})$ and $C_0^n(\mathbb{R})$

From the structure of $C_n^0(\mathbb{R})$ and $C_0^n(\mathbb{R})$ for low values of n , we can construct all of these algebras by using Theorem 27.4.3. First, let us collect the results of Examples 27.2.6, 27.4.1, and 27.4.2:

$$C_0^1(\mathbb{R}) \cong \mathbb{C}, \quad C_1^0(\mathbb{R}) \cong \mathbb{R} \oplus \mathbb{R}, \quad C_2^0(\mathbb{R}) \cong \mathcal{L}(\mathbb{R}^2), \quad C_0^2(\mathbb{R}) \cong \mathbb{H}. \tag{27.49}$$

Next let $\mu = 1$ and $\nu = 0$ in the first equation of Theorem 27.4.3 to obtain

$$C_0^3(\mathbb{R}) \cong C_1^0(\mathbb{R}) \otimes C_0^2(\mathbb{R}) \cong (\mathbb{R} \oplus \mathbb{R}) \otimes \mathbb{H} \cong (\mathbb{R} \otimes \mathbb{H}) \oplus (\mathbb{R} \otimes \mathbb{H}) \cong \mathbb{H} \oplus \mathbb{H},$$

where we used Eqs. (2.16) and (2.18). Similarly, with $\mu = 0$ and $\nu = 1$, the second equation of Theorem 27.4.3 yields

$$C_3^0(\mathbb{R}) \cong C_0^1(\mathbb{R}) \otimes C_2^0(\mathbb{R}) \cong \mathbb{C} \otimes \mathcal{L}(\mathbb{R}^2).$$

Setting $\mu = 2$, $\nu = 0$ in the first equation of Theorem 27.4.3, we obtain

$$C_0^4(\mathbb{R}) \cong C_4^0(\mathbb{R}) \cong C_2^0(\mathbb{R}) \otimes C_2^0(\mathbb{R}) \cong \mathcal{L}(\mathbb{R}^2) \otimes \mathbb{H} \cong \mathbb{H} \otimes \mathcal{L}(\mathbb{R}^2)$$

Table 27.1 Classification of $\mathbf{C}_n^0(\mathbb{R})$ and $\mathbf{C}_0^n(\mathbb{R})$ for $n \leq 8$

| n | $\mathbf{C}_n^0(\mathbb{R})$ | $\mathbf{C}_0^n(\mathbb{R})$ |
|-----|--|---|
| 1 | $\mathbb{R} \oplus \mathbb{R}$ | \mathbb{C} |
| 2 | $\mathcal{L}(\mathbb{R}^2)$ | \mathbb{H} |
| 3 | $\mathbb{C} \otimes \mathcal{L}(\mathbb{R}^2)$ | $\mathbb{H} \oplus \mathbb{H}$ |
| 4 | $\mathbb{H} \otimes \mathcal{L}(\mathbb{R}^2)$ | $\mathbb{H} \otimes \mathcal{L}(\mathbb{R}^2)$ |
| 5 | $(\mathbb{H} \otimes \mathcal{L}(\mathbb{R}^2)) \oplus (\mathbb{H} \otimes \mathcal{L}(\mathbb{R}^2))$ | $\mathbb{C} \otimes \mathcal{L}(\mathbb{R}^2) \otimes \mathbb{H}$ |
| 6 | $\mathbb{H} \otimes \mathcal{L}(\mathbb{R}^4)$ | $\mathcal{L}(\mathbb{R}^8)$ |
| 7 | $\mathbb{C} \otimes \mathbb{H} \otimes \mathcal{L}(\mathbb{R}^4)$ | $\mathcal{L}(\mathbb{R}^8) \oplus \mathcal{L}(\mathbb{R}^8)$ |
| 8 | $\mathcal{L}(\mathbb{R}^{16})$ | $\mathcal{L}(\mathbb{R}^{16})$ |

where the first isomorphism comes from Eq. (27.44) and the last from Eq. (2.17). We can continue the construction of the rest of $\mathbf{C}_n^0(\mathbb{R})$ and $\mathbf{C}_0^n(\mathbb{R})$ for $n \leq 8$. The results are tabulated in Table 27.1. The reader is urged to verify that the entries of the table are consistent with Theorem 27.3.4, keeping in mind that $\mathcal{L}(\mathbb{R}^n)$ can be identified as the total matrix algebra $\mathbb{R} \otimes \mathcal{M}_n$.

Let $\mathcal{V} = \mathbb{R}_0^8$ and $\mathcal{U} = \mathbb{R}_0^n$, noting that $\mathbf{e}_\Delta^2 = \mathbf{1}$ for $\mathcal{C}_\mathcal{V} = \mathbf{C}_8^0(\mathbb{R})$. Now use Theorem 27.2.16 to obtain

$$\mathcal{C}_{\mathbb{R}_0^8 \oplus \mathbb{R}_0^n} \cong \mathcal{C}_{\mathbb{R}_0^8} \otimes \mathcal{C}_{\mathbb{R}_0^n} \quad \text{or} \quad \mathcal{C}_{\mathbb{R}_0^{n+8}} \cong \mathcal{C}_{\mathbb{R}_0^8} \otimes \mathcal{C}_{\mathbb{R}_0^n}$$

or

$$\mathbf{C}_{n+8}^0(\mathbb{R}) \cong \mathbf{C}_n^0(\mathbb{R}) \otimes \mathbf{C}_8^0(\mathbb{R}) \cong \mathbf{C}_n^0(\mathbb{R}) \otimes \mathcal{L}(\mathbb{R}^{16}). \tag{27.50}$$

Similarly, using $\mathcal{V} = \mathbb{R}_8^8$ and $\mathcal{U} = \mathbb{R}_n^n$ in Theorem 27.2.16 yields

$$\mathbf{C}_0^{n+8}(\mathbb{R}) \cong \mathbf{C}_0^n(\mathbb{R}) \otimes \mathcal{L}(\mathbb{R}^{16}). \tag{27.51}$$

It is clear that these two equations plus Table 27.1 generate $\mathbf{C}_0^n(\mathbb{R})$ and $\mathbf{C}_n^0(\mathbb{R})$ for all n .⁴

Matrices are much more convenient and intuitive to use than linear transformations. It is therefore instructive to rewrite Table 27.1 in terms of matrices keeping in mind that with \mathbb{F} being \mathbb{C} or \mathbb{H} ,

$$\mathcal{L}(\mathbb{R}^n) \cong \mathcal{M}_n(\mathbb{R}) \quad \text{and} \quad \mathbb{F} \otimes \mathcal{L}(\mathbb{R}^n) \cong \mathbb{F} \otimes \mathcal{M}_n(\mathbb{R}) \cong \mathcal{M}_n(\mathbb{F}), \tag{27.52}$$

where $\mathcal{M}_n(\mathbb{F})$ denotes an $n \times n$ matrix with entries in \mathbb{F} . The results are given in Table 27.2.

We also write the periodicity relations (27.50) and (27.51) in terms of matrices:

$$\begin{aligned} \mathbf{C}_{n+8}^0(\mathbb{R}) &\cong \mathbf{C}_n^0(\mathbb{R}) \otimes \mathcal{M}_{16}(\mathbb{R}) \\ \mathbf{C}_0^{n+8}(\mathbb{R}) &\cong \mathbf{C}_0^n(\mathbb{R}) \otimes \mathcal{M}_{16}(\mathbb{R}). \end{aligned} \tag{27.53}$$

⁴It is worth noting that, by using $\mathcal{V} = \mathbb{R}_0^4$ or $\mathcal{V} = \mathbb{R}_4^4$, we could obtain formulas for $\mathbf{C}_{n+4}^0(\mathbb{R})$ and $\mathbf{C}_0^{n+4}(\mathbb{R})$ analogous to (27.50) and (27.51). However, as entries 5, 6, and 7 of Table 27.1 can testify, they would not be as appealing as the formulas obtained above. This is primarily because $\mathbf{C}_0^8(\mathbb{R}) \cong \mathbf{C}_8^0(\mathbb{R}) \cong \mathcal{L}(\mathbb{R}^{16})$.

Table 27.2 Classification of $C_n^0(\mathbb{R})$ and $C_0^n(\mathbb{R})$ for $n \leq 8$ in terms of matrices

| n | $C_n^0(\mathbb{R})$ | $C_0^n(\mathbb{R})$ |
|-----|---|---|
| 1 | $\mathbb{R} \oplus \mathbb{R}$ | \mathbb{C} |
| 2 | $\mathcal{M}_2(\mathbb{R})$ | \mathbb{H} |
| 3 | $\mathbb{C} \otimes \mathcal{M}_2(\mathbb{R}) \cong \mathcal{M}_2(\mathbb{C})$ | $\mathbb{H} \oplus \mathbb{H}$ |
| 4 | $\mathbb{H} \otimes \mathcal{M}_2(\mathbb{R}) \cong \mathcal{M}_2(\mathbb{H})$ | $\mathbb{H} \otimes \mathcal{M}_2(\mathbb{R}) \cong \mathcal{M}_2(\mathbb{H})$ |
| 5 | $\mathcal{M}_2(\mathbb{H}) \oplus \mathcal{M}_2(\mathbb{H})$ | $\mathbb{H} \otimes \mathcal{M}_2(\mathbb{C}) \cong \mathbb{C} \otimes \mathcal{M}_2(\mathbb{H})$ |
| 6 | $\mathbb{H} \otimes \mathcal{M}_4(\mathbb{R}) \cong \mathcal{M}_4(\mathbb{H})$ | $\mathcal{M}_8(\mathbb{R})$ |
| 7 | $\mathbb{H} \otimes \mathcal{M}_4(\mathbb{C}) \cong \mathbb{C} \otimes \mathcal{M}_4(\mathbb{H})$ | $\mathcal{M}_8(\mathbb{R}) \oplus \mathcal{M}_8(\mathbb{R})$ |
| 8 | $\mathcal{M}_{16}(\mathbb{R})$ | $\mathcal{M}_{16}(\mathbb{R})$ |

27.4.2 Classification of $C_\mu^\nu(\mathbb{R})$

We can now complete the task of classifying all of the algebras $C_\mu^\nu(\mathbb{R})$. The case of $\mu = \nu$ is given by Eq. (27.47). For the case of $\mu > \nu$, let $\mu = \nu + \sigma$ and note that

$$\mathbb{R}_\nu^n = \mathbb{R}_0^\mu \oplus \mathbb{R}_\nu^\nu = (\mathbb{R}_0^\sigma \oplus \mathbb{R}_0^\nu) \oplus \mathbb{R}_\nu^\nu = \mathbb{R}_0^\sigma \oplus (\mathbb{R}_0^\nu \oplus \mathbb{R}_\nu^\nu) = \mathbb{R}_0^\sigma \oplus \mathbb{R}_\nu^{2\nu}.$$

Now let $\mathcal{V} = \mathbb{R}_\nu^{2\nu}$ and note that $\mathcal{C}_\mathcal{V} = C_\nu^\nu(\mathbb{R})$. Furthermore, Eq. (27.38), with $N = 2\nu$ gives $\mathbf{e}_\Delta^2 = \mathbf{1}$. Hence, with $\mathcal{U} = \mathbb{R}_0^\sigma$, the first equation of Theorem 27.2.16 yields

$$C_\mu^\nu(\mathbb{R}) \cong C_\nu^\nu(\mathbb{R}) \otimes C_\sigma^0(\mathbb{R}) \cong \mathcal{L}(\mathbb{R}^{2\nu}) \otimes C_\sigma^0(\mathbb{R}), \tag{27.54}$$

where we used (27.47).

If $\mu < \nu$, let $\nu = \mu + \rho$ and note that $\mathbb{R}_\nu^n = \mathbb{R}_\rho^\rho \oplus \mathbb{R}_\mu^{2\mu}$. With $\mathcal{V} = \mathbb{R}_\mu^{2\mu}$ and $\mathcal{U} = \mathbb{R}_\rho^\rho$, the first equation of Theorem 27.2.16 yields

$$C_\mu^\nu(\mathbb{R}) \cong C_\mu^\mu(\mathbb{R}) \otimes C_\rho^0(\mathbb{R}) \cong \mathcal{L}(\mathbb{R}^{2\mu}) \otimes C_\rho^0(\mathbb{R}). \tag{27.55}$$

It is worthwhile to collect these results in a theorem. Noting that $C_0^0 \cong \mathbb{R}$ and that $\mathcal{A} \otimes \mathbb{R} = \mathcal{A}$ for any real algebra, we can combine the three cases of $\mu = \nu$, $\mu > \nu$, and $\mu < \nu$ into two cases:

Theorem 27.4.6 *The following isomorphisms hold:*

$$\begin{aligned} C_\mu^\nu(\mathbb{R}) &\cong \mathcal{L}(\mathbb{R}^{2\nu}) \otimes C_{\mu-\nu}^0(\mathbb{R}) \cong \mathcal{M}_{2\nu}(\mathbb{R}) \otimes C_{\mu-\nu}^0(\mathbb{R}), & \text{if } \mu \geq \nu, \\ C_\mu^\nu(\mathbb{R}) &\cong \mathcal{L}(\mathbb{R}^{2\mu}) \otimes C_0^{\nu-\mu}(\mathbb{R}) \cong \mathcal{M}_{2\mu}(\mathbb{R}) \otimes C_0^{\nu-\mu}(\mathbb{R}), & \text{if } \mu \leq \nu. \end{aligned}$$

This theorem together with Table (27.2) and the periodicity relations

$$\begin{aligned} C_{\mu+8}^\nu(\mathbb{R}) &\cong C_\mu^\nu(\mathbb{R}) \otimes \mathcal{M}_{16}(\mathbb{R}) \\ C_{\mu+8}^{\nu+8}(\mathbb{R}) &\cong C_\mu^\nu(\mathbb{R}) \otimes \mathcal{M}_{16}(\mathbb{R}), \end{aligned} \tag{27.56}$$

which come from Eq. (27.53), determine all the algebras $\mathbf{C}_\mu^\nu(\mathbb{R})$.

From Theorem 27.4.6, the periodicity relation (27.53), and Table 27.2, we get the following:

Theorem 27.4.7 *All Clifford algebras $\mathbf{C}_\mu^\nu(\mathbb{R})$ with $\mu - \nu \not\equiv 1 \pmod{4}$ are simple. Those with $\mu - \nu \equiv 1 \pmod{4}$ are direct sums of two identical simple algebras.*

27.4.3 The Algebra $\mathbf{C}_3^1(\mathbb{R})$

For the Minkowski n -space, \mathbb{R}_1^n , Theorem 27.4.6 gives

$$\mathbf{C}_{n-1}^1(\mathbb{R}) \cong \mathcal{M}_2(\mathbb{R}) \otimes \mathbf{C}_{n-2}^0(\mathbb{R}).$$

When $n = 4$, this reduces to

$$\mathbf{C}_3^1(\mathbb{R}) \cong \mathcal{M}_2(\mathbb{R}) \otimes \mathbf{C}_2^0(\mathbb{R}) \cong \mathcal{M}_2(\mathbb{R}) \otimes \mathcal{M}_2(\mathbb{R}) \cong \mathcal{M}_4(\mathbb{R}).$$

In the language of Chap. 3, $\mathbf{C}_3^1(\mathbb{R})$ is a total matrix algebra, which, by either Theorem 3.5.27 (and the remarks after it) or Theorem 3.3.2, is simple. We now find a basis $\{\mathbf{e}_{ij}\}$ of this algebra.

First we find the diagonals $\{\mathbf{e}_{ii}\}_{i=1}^4$, which are obviously primitive, orthogonal to each other, and

$$\mathbf{1} = \mathbf{e}_{11} + \mathbf{e}_{22} + \mathbf{e}_{33} + \mathbf{e}_{44}.$$

Thus, by Theorem 3.5.32, the identity has rank 4. Next, we construct four primitive orthogonal idempotents $\{\mathbf{P}_i\}_{i=1}^4$ out of the basis vectors⁵ $\{\hat{\mathbf{e}}_\eta\}_{\eta=0}^3$ of $\mathbf{C}_3^1(\mathbb{R})$ and their products and identify them with $\{\mathbf{e}_{ii}\}_{i=1}^4$. The easiest way to construct these idempotents is to find \mathbf{x} and \mathbf{y} such that

$$\mathbf{x}^2 = \mathbf{1} = \mathbf{y}^2, \quad \mathbf{xy} = \mathbf{yx}.$$

Then the product of $\frac{1}{2}(\mathbf{1} \pm \mathbf{x})$ and $\frac{1}{2}(\mathbf{1} \pm \mathbf{y})$ for all sign choices yields four primitive orthogonal idempotents, as the reader may verify. There are many choices for \mathbf{x} and \mathbf{y} . We choose $\mathbf{x} = \hat{\mathbf{e}}_1$ and $\mathbf{y} = \hat{\mathbf{e}}_{02}$, where we use the common abbreviation $\hat{\mathbf{e}}_{\eta_1 \dots \eta_p} \equiv \hat{\mathbf{e}}_{\eta_1} \vee \dots \vee \hat{\mathbf{e}}_{\eta_p}$, and set

$$\begin{aligned} \mathbf{P}_1 &= \frac{1}{4}(\mathbf{1} + \hat{\mathbf{e}}_1)(\mathbf{1} + \hat{\mathbf{e}}_{02}) \equiv \mathbf{e}_{11}, \\ \mathbf{P}_2 &= \frac{1}{4}(\mathbf{1} + \hat{\mathbf{e}}_1)(\mathbf{1} - \hat{\mathbf{e}}_{02}) \equiv \mathbf{e}_{22}, \\ \mathbf{P}_3 &= \frac{1}{4}(\mathbf{1} - \hat{\mathbf{e}}_1)(\mathbf{1} + \hat{\mathbf{e}}_{02}) \equiv \mathbf{e}_{33}, \\ \mathbf{P}_4 &= \frac{1}{4}(\mathbf{1} - \hat{\mathbf{e}}_1)(\mathbf{1} - \hat{\mathbf{e}}_{02}) \equiv \mathbf{e}_{44}. \end{aligned} \tag{27.57}$$

⁵Here we are using the physicists' convention of numbering the basis vectors from 0 to 3 with $\hat{\mathbf{e}}_0 = \hat{\mathbf{e}}_4$ and using Greek letters for indices.

Since the \mathbf{P}_i s are all primitive (thus, of rank 1), by Theorem 3.5.32, they are similar. Indeed, one can easily show that

$$\begin{aligned}\hat{\mathbf{e}}_3\mathbf{P}_1\hat{\mathbf{e}}_3^{-1} &= \hat{\mathbf{e}}_3\mathbf{P}_1\hat{\mathbf{e}}_3 = \mathbf{P}_2, \\ \hat{\mathbf{e}}_3\mathbf{P}_1\hat{\mathbf{e}}_3^{-1} &= \hat{\mathbf{e}}_3\mathbf{P}_1\hat{\mathbf{e}}_3 = \mathbf{P}_3, \\ \hat{\mathbf{e}}_0\mathbf{P}_1\hat{\mathbf{e}}_0^{-1} &= -\hat{\mathbf{e}}_0\mathbf{P}_1\hat{\mathbf{e}}_0 = \mathbf{P}_4.\end{aligned}\tag{27.58}$$

Equations (27.57) and (27.58) determine all \mathbf{e}_{ij} s, as we now demonstrate. Write the first relation of (27.58) as $\hat{\mathbf{e}}_3\mathbf{P}_1 = \mathbf{P}_2\hat{\mathbf{e}}_3$ or $\hat{\mathbf{e}}_3\mathbf{e}_{11} = \mathbf{e}_{22}\hat{\mathbf{e}}_3$. Since $\hat{\mathbf{e}}_3 \in C_3^1(\mathbb{R})$, it can be written as a linear combination of $\{\mathbf{e}_{ij}\}$. With $\hat{\mathbf{e}}_3 = \sum_{i,j=1}^4 \alpha_{ij}\mathbf{e}_{ij}$, we have

$$\sum_{i,j=1}^4 \alpha_{ij}\mathbf{e}_{ij}\mathbf{e}_{11} = \mathbf{e}_{22} \sum_{i,j=1}^4 \alpha_{ij}\mathbf{e}_{ij} \quad \text{or} \quad \sum_{i=1}^4 \alpha_{i1}\mathbf{e}_{i1} = \sum_{j=1}^4 \alpha_{2j}\mathbf{e}_{2j}.$$

Linear independence of $\{\mathbf{e}_{ij}\}$ implies that $\alpha_{i1} = 0$ for $i \neq 2$ and $\alpha_{2j} = 0$ for $j \neq 1$. Therefore, the left-hand side (or the right-hand side) of the equation reduces to $\alpha_{21}\mathbf{e}_{21}$. Hence, we have

$$\hat{\mathbf{e}}_3\mathbf{P}_1 = \alpha_{21}\mathbf{e}_{21}.\tag{27.59}$$

We can also write the first relation of (27.58) as $\mathbf{P}_1\hat{\mathbf{e}}_3 = \hat{\mathbf{e}}_3\mathbf{P}_2$ or $\mathbf{e}_{11}\hat{\mathbf{e}}_3 = \hat{\mathbf{e}}_3\mathbf{e}_{22}$, which yields

$$\mathbf{e}_{11} \sum_{i,j=1}^4 \alpha_{ij}\mathbf{e}_{ij} = \sum_{i,j=1}^4 \alpha_{ij}\mathbf{e}_{ij}\mathbf{e}_{22} \quad \text{or} \quad \sum_{j=1}^4 \alpha_{1j}\mathbf{e}_{1j} = \sum_{i=1}^4 \alpha_{i2}\mathbf{e}_{i2}.$$

Again, linear independence of $\{\mathbf{e}_{ij}\}$ implies that $\alpha_{1j} = 0$ for $j \neq 2$ and $\alpha_{i2} = 0$ for $i \neq 1$. Therefore, the left-hand side (or the right-hand side) of the equation reduces to $\alpha_{12}\mathbf{e}_{12}$, and we get

$$\mathbf{P}_1\hat{\mathbf{e}}_3 = \alpha_{12}\mathbf{e}_{12}.\tag{27.60}$$

Multiply Eqs. (27.59) and (27.60) to get

$$(\hat{\mathbf{e}}_3\mathbf{P}_1)(\mathbf{P}_1\hat{\mathbf{e}}_3) = (\alpha_{21}\mathbf{e}_{21})(\alpha_{12}\mathbf{e}_{12})$$

or

$$\hat{\mathbf{e}}_3\mathbf{P}_1\hat{\mathbf{e}}_3 = \alpha_{21}\alpha_{12}\mathbf{e}_{21}\mathbf{e}_{12} = \alpha_{21}\alpha_{12}\mathbf{e}_{22} = \alpha_{21}\alpha_{12}\mathbf{P}_2.$$

Comparing this with the first equation in (27.58), we conclude that $\alpha_{21}\alpha_{12} = 1$, which is also a consistency condition for $\hat{\mathbf{e}}_3 \vee \hat{\mathbf{e}}_3 = \mathbf{1}$. There are several choices for α_{ij} , all of which satisfy this as well as other conditions obtained above. Therefore, we are at liberty to set $\alpha_{21} = 1 = \alpha_{12}$ and write

$$\hat{\mathbf{e}}_3\mathbf{P}_1 = \mathbf{e}_{21}, \quad \mathbf{P}_1\hat{\mathbf{e}}_3 = \hat{\mathbf{e}}_3\mathbf{P}_2 = \mathbf{e}_{12}.\tag{27.61}$$

Table 27.3 The basis \mathbf{e}_{ij} for the total matrix algebra $\mathbf{C}_3^1(\mathbb{R})$

| \mathbf{e}_{ij} | $j = 1$ | $j = 2$ | $j = 3$ | $j = 4$ |
|-------------------|-------------------------------------|-------------------------------------|-------------------------------------|-------------------------------------|
| $i = 1$ | \mathbf{P}_1 | $\hat{\mathbf{e}}_{03}\mathbf{P}_2$ | $\hat{\mathbf{e}}_3\mathbf{P}_3$ | $-\hat{\mathbf{e}}_0\mathbf{P}_4$ |
| $i = 2$ | $\hat{\mathbf{e}}_{03}\mathbf{P}_1$ | \mathbf{P}_2 | $\hat{\mathbf{e}}_0\mathbf{P}_3$ | $-\hat{\mathbf{e}}_3\mathbf{P}_4$ |
| $i = 3$ | $\hat{\mathbf{e}}_3\mathbf{P}_1$ | $-\hat{\mathbf{e}}_0\mathbf{P}_2$ | \mathbf{P}_3 | $\hat{\mathbf{e}}_{03}\mathbf{P}_4$ |
| $i = 4$ | $\hat{\mathbf{e}}_0\mathbf{P}_1$ | $-\hat{\mathbf{e}}_3\mathbf{P}_2$ | $\hat{\mathbf{e}}_{03}\mathbf{P}_3$ | \mathbf{P}_4 |

Going through the same procedure using the second and third relations of (27.58), we obtain

$$\begin{aligned}\hat{\mathbf{e}}_3\mathbf{P}_1 &= \mathbf{e}_{31}, & \mathbf{P}_1\hat{\mathbf{e}}_3 &= \hat{\mathbf{e}}_3\mathbf{P}_3 = \mathbf{e}_{13}, \\ \hat{\mathbf{e}}_0\mathbf{P}_1 &= \mathbf{e}_{41}, & \mathbf{P}_1\hat{\mathbf{e}}_0 &= \hat{\mathbf{e}}_0\mathbf{P}_4 = -\mathbf{e}_{14}.\end{aligned}\tag{27.62}$$

Having found \mathbf{e}_{i1} and \mathbf{e}_{1j} , we can find all the \mathbf{e}_{ij} because $\mathbf{e}_{ij} = \mathbf{e}_{i1}\mathbf{e}_{1j}$. The result is summarized in Table 27.3.

Now that we have the basis we were after, we can express the basis vectors $\{\hat{\mathbf{e}}_\eta\}_{\eta=0}^3$ of the underlying vector space in terms of the new basis. Writing

$$\hat{\mathbf{e}}_\eta = \sum_{i,j=1}^4 \gamma_{\eta,ij} \mathbf{e}_{ij},$$

multiplying it on the right by \mathbf{e}_{kl} and on the left by \mathbf{e}_{mn} , we obtain

$$\mathbf{e}_{mn}\hat{\mathbf{e}}_\eta\mathbf{e}_{kl} = \gamma_{\eta,nk}\mathbf{e}_{ml},$$

which, for $m = 1 = l$ yields

$$\mathbf{e}_{1n}\hat{\mathbf{e}}_\eta\mathbf{e}_{k1} = \gamma_{\eta,nk}\mathbf{e}_{11}.\tag{27.63}$$

Thus, to find $\gamma_{\eta,nk}$, multiply $\hat{\mathbf{e}}_\eta$ on the left by \mathbf{e}_{1n} and on the right by \mathbf{e}_{k1} and read the coefficient of \mathbf{e}_{11} in the expression obtained. As an example, we find $\gamma_{3,12}$. We have

$$\mathbf{e}_{11}\hat{\mathbf{e}}_3\mathbf{e}_{21} = \gamma_{3,12}\mathbf{e}_{11}.$$

The left-hand side can be evaluated from the table:

$$\begin{aligned}\mathbf{e}_{11}\hat{\mathbf{e}}_3\mathbf{e}_{21} &= \mathbf{e}_{11}\hat{\mathbf{e}}_3\hat{\mathbf{e}}_{03}\mathbf{P}_1 = \mathbf{e}_{11}\hat{\mathbf{e}}_3 \vee \hat{\mathbf{e}}_0 \vee \hat{\mathbf{e}}_3\mathbf{P}_1 \\ &= -\mathbf{e}_{11}\hat{\mathbf{e}}_3 \vee \hat{\mathbf{e}}_3 \vee \hat{\mathbf{e}}_0\mathbf{P}_1 \\ &= -\mathbf{e}_{11}\hat{\mathbf{e}}_0\mathbf{P}_1 = -\mathbf{e}_{11}\mathbf{e}_{41} = \mathbf{0}.\end{aligned}$$

Thus, $\gamma_{3,12} = 0$. Similarly, we find $\gamma_{3,13}$:

$$\mathbf{e}_{11}\hat{\mathbf{e}}_3\mathbf{e}_{31} = \gamma_{3,13}\mathbf{e}_{11}.$$

Using Table 27.3, we get

$$\mathbf{e}_{11}\hat{\mathbf{e}}_3\mathbf{e}_{31} = \mathbf{e}_{11}\hat{\mathbf{e}}_3\hat{\mathbf{e}}_3\mathbf{P}_1 = \mathbf{e}_{11}\hat{\mathbf{e}}_3 \vee \hat{\mathbf{e}}_3\mathbf{P}_1 = \mathbf{e}_{11}\mathbf{1}\mathbf{e}_{11} = \mathbf{e}_{11}.$$

Thus, $\gamma_{3,13} = 1$.

We can continue this way and obtain all coefficients $\gamma_{\eta,ij}$. However, an easier way is to solve for $\hat{\mathbf{e}}_{\eta}$ from Eq. (27.57). Thus

$$\hat{\mathbf{e}}_1 = \mathbf{P}_1 + \mathbf{P}_2 - \mathbf{P}_3 - \mathbf{P}_4 = \mathbf{e}_{11} + \mathbf{e}_{22} - \mathbf{e}_{33} - \mathbf{e}_{44},$$

giving the matrix

$$\gamma_1 = \begin{pmatrix} 1 & 0 & 0 & 0 \\ 0 & 1 & 0 & 0 \\ 0 & 0 & -1 & 0 \\ 0 & 0 & 0 & -1 \end{pmatrix}.$$

Similarly,

$$\hat{\mathbf{e}}_{02} = \mathbf{P}_1 + \mathbf{P}_3 - \mathbf{P}_2 - \mathbf{P}_4, \tag{27.64}$$

from which we can get $\hat{\mathbf{e}}_2$ by multiplying on the left by $\hat{\mathbf{e}}_0$ and noting that

$$\hat{\mathbf{e}}_0 \hat{\mathbf{e}}_{02} = \hat{\mathbf{e}}_0 \hat{\mathbf{e}}_0 \hat{\mathbf{e}}_2 = -\hat{\mathbf{e}}_2.$$

Thus,

$$\hat{\mathbf{e}}_2 = -\hat{\mathbf{e}}_0 \mathbf{P}_1 - \hat{\mathbf{e}}_0 \mathbf{P}_3 + \hat{\mathbf{e}}_0 \mathbf{P}_2 + \hat{\mathbf{e}}_0 \mathbf{P}_4 = -\mathbf{e}_{41} - \mathbf{e}_{23} - \mathbf{e}_{32} - \mathbf{e}_{14} \tag{27.65}$$

where use was made of Table 27.3 in the last step. It follows that

$$\gamma_2 = \begin{pmatrix} 0 & 0 & 0 & -1 \\ 0 & 0 & -1 & 0 \\ 0 & -1 & 0 & 0 \\ -1 & 0 & 0 & 0 \end{pmatrix}.$$

The remaining two matrices can be obtained similarly. The details are left as Problem 27.22. The result is

$$\gamma_3 = \begin{pmatrix} 0 & 0 & 1 & 0 \\ 0 & 0 & 0 & -1 \\ 1 & 0 & 0 & 0 \\ 0 & -1 & 0 & 0 \end{pmatrix}, \quad \gamma_0 = \begin{pmatrix} 0 & 0 & 0 & -1 \\ 0 & 0 & 1 & 0 \\ 0 & -1 & 0 & 0 \\ 1 & 0 & 0 & 0 \end{pmatrix}.$$

Since $\hat{\mathbf{e}}_{\mu} \vee \hat{\mathbf{e}}_{\nu} + \hat{\mathbf{e}}_{\nu} \vee \hat{\mathbf{e}}_{\mu} = 2\eta_{\mu\nu}$ by (27.15) and (27.40), we have

$$\gamma_{\mu} \gamma_{\nu} + \gamma_{\nu} \gamma_{\mu} = 2\eta_{\mu\nu} \mathbf{1}, \tag{27.66}$$

which can also be verified directly by matrix multiplication. Equation (27.66) is identical to (27.11) obeyed by the Dirac gamma matrices. The matrices that Dirac used in his equation had complex entries. The matrices constructed above are all real. They are called the **Majorana representation** of the Dirac matrices.

Majorana representation

27.5 Problems

27.1 Starting with Eq. (27.8), write $\mathbf{e}_{i_{p-1}} \vee \mathbf{e}_{i_p}$ in terms of the wedge product using Eq. (27.3). Then use the more general Clifford product (27.2) repeatedly until you have turned all the \vee 's to \wedge 's.

27.2 Find the coefficients of $\mathbf{1}$, \mathbf{e}_1 , \mathbf{e}_2 , and $\mathbf{e}_1 \vee \mathbf{e}_2$ for the Clifford product $\mathbf{u} \vee \mathbf{v}$ of Example 27.2.2.

27.3 Show that Eqs. (27.24) and (27.25) are equivalent.

27.4 Show that because of (27.24), φ can be extended to an algebra homomorphism only if it is an *injective* linear map.

27.5 Show that the conjugation involution of Definition 27.2.5 coincides with the usual complex and quaternion conjugation. Show that $\overline{\mathbf{a} \vee \mathbf{b}} = \overline{\mathbf{b}} \vee \overline{\mathbf{a}}$.

27.6 Let $\varphi : \mathbb{R} \rightarrow \mathbb{R} \oplus \mathbb{R}$ be a linear map. Assume a completely general form for φ , i.e., assume $\varphi(\alpha) = (\beta \oplus \gamma)$. Extend this linear map to a homomorphism $\phi : \mathbf{C}_1^0 \rightarrow \mathbb{R} \oplus \mathbb{R}$. Imposing the consistency condition (27.25), deduce that $\beta^2 = \alpha^2 = \gamma^2$. Now show that a non-trivial homomorphism sends $\mathbf{1}$ to $1 \oplus 1$ and \mathbf{e} to $1 \oplus -1$, and therefore is an isomorphism. Finally for a general element of \mathbf{C}_1^0 , show that

$$\phi(\alpha \mathbf{1} + \beta \mathbf{e}) = (\alpha + \beta, \alpha - \beta), \quad \alpha, \beta \in \mathbb{R}.$$

27.7 Show that the four matrices

$$\begin{pmatrix} 1 & 0 \\ 0 & 1 \end{pmatrix}, \quad \begin{pmatrix} 1 & 0 \\ 0 & -1 \end{pmatrix}, \quad \begin{pmatrix} 0 & 1 \\ 1 & 0 \end{pmatrix}, \quad \begin{pmatrix} 0 & 1 \\ -1 & 0 \end{pmatrix}$$

are linearly independent.

27.8 Derive Eq. (27.33).

27.9 Show that the center \mathcal{Z}_V is a subalgebra of \mathcal{C}_V .

27.10 Show that both \mathcal{Z}_V and $\overline{\mathcal{Z}}_V$ are invariant under the degree involution ω_V .

27.11 Let $\mathbf{Q}_V : \mathcal{V} \rightarrow \mathbb{F}$ be a quadratic form defined in terms of the basis $\{\mathbf{e}_i\}_{i=1}^n$ and \mathbf{g} the inner product derived from \mathbf{Q}_V . Show that $\mathbf{g}(\mathbf{e}_i, \mathbf{e}_j) = \pm \delta_{ij}$.

27.12 Let $\mathbf{u}, \mathbf{v} \in \mathbb{R}_\mu^{2\mu}$ of Eq. (27.45). Write \mathbf{u} and \mathbf{v} in terms of the basis vectors $\{\hat{\mathbf{e}}_i\}_{i=1}^\mu$ and $\{\hat{\mathbf{f}}_i\}_{i=1}^\mu$ and show that the ω of Eq. (27.46) satisfies $\langle \mathbf{u}, \omega \mathbf{v} \rangle = \langle -\omega \mathbf{u}, \mathbf{v} \rangle$, implying that $\omega^t = -\omega$. With $\mathbf{u} = \sum_{i=1}^\mu (\alpha_i \hat{\mathbf{e}}_i + \beta_i \hat{\mathbf{f}}_i)$, show that $\mathbf{u} \in \ker(\omega - \iota)$ iff $\alpha_i = \beta_i$.

27.13 Following Example 27.2.6, show directly that $\mathbf{C}_1^1(\mathbb{R}) \cong \mathcal{L}(\mathbb{R}^2) \cong \mathcal{M}^{2 \times 2}$.

27.14 Let $\mathbf{x} = (x_1, x_2, x_3, x_4) \in \mathcal{L}(\mathbb{R}^4)$. Define $\phi : \mathbb{H} \otimes \mathbb{H} \rightarrow \mathcal{L}(\mathbb{R}^4)$ by

$$\phi(\mathbf{p} \otimes \mathbf{q})\mathbf{x} = \mathbf{p} \cdot \mathbf{x} \cdot \mathbf{q}^*, \quad \mathbf{p}, \mathbf{q} \in \mathbb{H}, \mathbf{x} \in \mathcal{L}(\mathbb{R}^4)$$

where on the right-hand side, $\mathbf{x} = x_1 + x_2i + x_3j + x_4k$ is a quaternion. Show that ϕ is an algebra homomorphism, whose kernel is zero. Now invoke the dimension theorem and the fact that $\mathbb{H} \otimes \mathbb{H}$ and $\mathcal{L}(\mathbb{R}^4)$ have the same dimension to show that ϕ is an isomorphism.

27.15 Let $\mathcal{V} = \mathbb{R}_0^4$ or $\mathcal{V} = \mathbb{R}_4^4$ and note that $\mathbf{e}_\Delta^2 = \mathbf{1}$ for $\mathcal{C}_\mathcal{V}$. Now use Theorem 27.2.17 to show that

$$\mathbf{C}_{8 \text{ or } 0}^{0 \text{ or } 8}(\mathbb{R}) \cong \mathbf{C}_{4 \text{ or } 0}^{0 \text{ or } 4}(\mathbb{R}) \otimes \mathbf{C}_{4 \text{ or } 0}^{0 \text{ or } 4}(\mathbb{R}).$$

27.16 Complete the remainder of Table 27.1.

27.17 Using $\mathcal{V} = \mathbb{R}_0^4$ or $\mathcal{V} = \mathbb{R}_4^4$, derive formulas for $\mathbf{C}_{n+4}^0(\mathbb{R})$ and $\mathbf{C}_0^{n+4}(\mathbb{R})$ analogous to (27.50) and (27.51).

27.18 Show that

$$\begin{aligned} \mathbf{C}_0^9(\mathbb{R}) &\cong \mathbb{C} \otimes \mathcal{L}(\mathbb{R}^{16}), & \mathbf{C}_9^0(\mathbb{R}) &\cong \mathcal{L}(\mathbb{R}^{16}) \oplus \mathcal{L}(\mathbb{R}^{16}), \\ \mathbf{C}_0^{10}(\mathbb{R}) &\cong \mathbb{H} \otimes \mathcal{L}(\mathbb{R}^{16}), & \mathbf{C}_{10}^0(\mathbb{R}) &\cong \mathcal{L}(\mathbb{R}^{32}). \end{aligned}$$

27.19 Show that if $\mathbf{x}^2 = \mathbf{1} = \mathbf{y}^2$ and $\mathbf{xy} = \mathbf{yx}$, then the four quantities $\frac{1}{4}(\mathbf{1} \pm \mathbf{x})(\mathbf{1} \pm \mathbf{y})$ are orthogonal idempotents.

27.20 Verify all of the relations in Eq. (27.58).

27.21 Derive Eq. (27.62).

27.22 Note that

$$\begin{aligned} \hat{\mathbf{e}}_0 &= \hat{\mathbf{e}}_0 \mathbf{1} = \hat{\mathbf{e}}_0 \mathbf{P}_1 + \hat{\mathbf{e}}_0 \mathbf{P}_2 + \hat{\mathbf{e}}_0 \mathbf{P}_3 + \hat{\mathbf{e}}_0 \mathbf{P}_4 \\ \hat{\mathbf{e}}_3 &= \hat{\mathbf{e}}_3 \mathbf{1} = \hat{\mathbf{e}}_3 \mathbf{P}_1 + \hat{\mathbf{e}}_3 \mathbf{P}_2 + \hat{\mathbf{e}}_3 \mathbf{P}_3 + \hat{\mathbf{e}}_3 \mathbf{P}_4. \end{aligned}$$

Now use Table 27.3 to express each term on the right in terms of \mathbf{e}_{ij} .

Tensor *algebra* deals with lifeless vectors and tensors—objects that do not move, do not change, possess no dynamics. Whenever there is a need for tensors in physics, there is also a need to know the way these tensors change with position and time. Tensors that depend on position and time are called tensor fields and are the subject of this chapter.

In studying the algebra of tensors, we learned that they are generalizations of vectors. Once we have a vector space \mathcal{V} and its dual space \mathcal{V}^* , we can take the tensor products of factors of \mathcal{V} and \mathcal{V}^* and create tensors of various kinds. Thus, once we know what a vector is, we can make up tensors from it.

In our discussion of tensor algebra, we did not concern ourselves with what a vector was; we simply assumed that it existed. Because all the vectors considered there were stationary, their mere existence was enough. However, in tensor analysis, where things keep changing from point to point (and over time), the existence of vectors at one point does not guarantee their existence at all points. Therefore, we now have to demand more from vectors than their mere existence. Tied to the concept of vectors is the notion of space, or space-time. Let us consider this first.

28.1 Differentiable Manifolds

Space is one of the undefinables in elementary physics. Length and time intervals are concepts that are “God given”, and any definitions of these concepts will be circular. This is true as long as we are confined within a single space. In classical physics, this space is the three-dimensional Euclidean space in which every motion takes place. In special relativity, space is changed to Minkowski space-time. In nonrelativistic quantum mechanics, the underlying space is the (infinite-dimensional) Hilbert space, and time is the only dynamical parameter. In the general theory of relativity, gravitation and space-time are intertwined through the concept of curvature.

Mathematicians have invented a unifying theme that brings the common features of all spaces together. This unifying theme is the theory of differentiable manifolds. A rigorous understanding of differentiable manifolds is

beyond the scope of this book. However, a working knowledge of manifold theory is surprisingly simple. Let us begin with a crude definition of a differentiable manifold.

differentiable manifold
provisionally defined

Definition 28.1.1 A **differentiable manifold** is a collection of objects called **points** that are connected to each other in a smooth fashion such that the neighborhood of each point looks like the neighborhood of an m -dimensional (Cartesian) space; m is called the **dimension** of the manifold.

As is customary in the literature, we use “manifold” to mean “differentiable manifold”.

Example 28.1.2 The following are examples of differentiable manifolds.

- (a) The space \mathbb{R}^n is an n -dimensional manifold.
- (b) The surface of a sphere is a two-dimensional manifold.
- (c) A torus is a two-dimensional manifold.
- (d) The collection of all $n \times n$ real matrices whose elements are real functions having derivatives of all orders is an n^2 -dimensional manifold. Here a point is an $n \times n$ matrix.
- (e) The collection of all rotations in \mathbb{R}^3 is a three-dimensional manifold. (Here a point is a rotation.)
- (f) Any smooth surface in \mathbb{R}^3 is a two-dimensional manifold.
- (g) The unit n -sphere S^n , which is the collection of points in \mathbb{R}^{n+1} satisfying

$$x_1^2 + \cdots + x_{n+1}^2 = 1,$$

is a manifold.

Any surface with sharp kinks, edges, or points cannot be a manifold. Thus, neither a cone nor a finite cylinder is a two-dimensional manifold. However, an infinitely long cylinder is a manifold.

Let U_P denote a neighborhood of P . When we say that this neighborhood looks like an m -dimensional Cartesian space, we mean that there exists a bijective map $\varphi : U_P \rightarrow \mathbb{R}^m$ from a neighborhood U_P of P to a neighborhood $\varphi(U_P)$ of $\varphi(P)$ in \mathbb{R}^m , such that as we move the point P continuously in U_P , its image moves *continuously* in $\varphi(U_P)$. Since $\varphi(P) \in \mathbb{R}^m$, we can define functions $x^i : U_P \rightarrow \mathbb{R}$ such that $\varphi(P) = (x^1(P), x^2(P), \dots, x^m(P))$. These functions are called **coordinate functions** of φ . The numbers $x^i(P)$ are called **coordinates** of P . The neighborhood U_P together with its mapping φ form a **chart**, denoted by (U_P, φ) .

coordinate functions
and charts

Now let (V_P, μ) be another chart at P with coordinate functions $\mu(P) = (y^1(P), y^2(P), \dots, y^m(P))$ (see Fig. 28.1). It is assumed that the map $\mu \circ \varphi^{-1} : \varphi(U_P \cap V_P) \rightarrow \mu(U_P \cap V_P)$, which maps a subset of \mathbb{R}^m to another subset of \mathbb{R}^m , possesses derivatives of all orders. Then, we say that the two charts μ and φ are \mathcal{C}^∞ -**related**. Such a relation underlies the concept of smoothness in the definition of a manifold. A collection of charts that cover the manifold and of which each pair is \mathcal{C}^∞ -related is called a \mathcal{C}^∞ **atlas**.

\mathcal{C}^∞ -related charts and
atlases

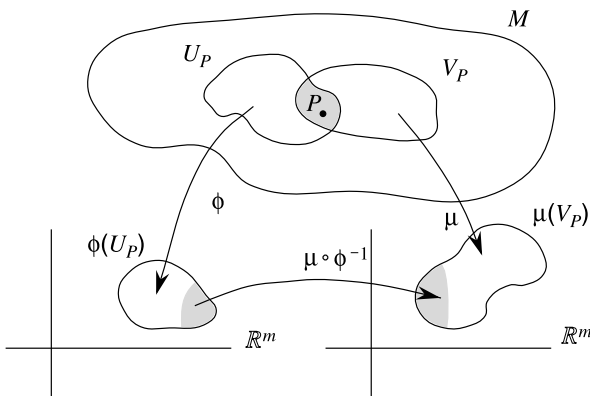

Fig. 28.1 Two charts (U_P, ϕ) and (V_P, μ) , containing P are mapped into \mathbb{R}^m . The function $\mu \circ \phi^{-1}$ is an ordinary function from \mathbb{R}^m to \mathbb{R}^m

Example 28.1.3 For the two-dimensional unit sphere S^2 we can construct an atlas as follows. Let $P = (x, y, z)$ be a point in S^2 . Then $x^2 + y^2 + z^2 = 1$, or

$$z = \pm\sqrt{1 - x^2 - y^2}.$$

The plus sign corresponds to the upper hemisphere, and the minus sign to the lower hemisphere. Let U_3^+ be the upper hemisphere *with the equator removed*. Then a chart (U_3^+, φ_3) with $\varphi_3 : U_3^+ \rightarrow \mathbb{R}^2$ can be constructed by projecting on the xy -plane: $\varphi_3(P) = (x, y)$. Similarly, (U_3^-, μ_3) with $\mu_3 : U_3^- \rightarrow \mathbb{R}^2$ given by $\mu_3(P) = (x, y)$ is a chart for the lower hemisphere.

In manifold theory the neighborhoods on which mappings of charts are defined have no boundaries (thus the word “open”). This is because it is more convenient to define limits on boundaryless (open) neighborhoods. Thus, in the above two charts the equator, which is the boundary for both hemispheres, must be excluded. With this exclusion U_3^+ and U_3^- cannot cover the entire S^2 ; hence, they do not form an atlas. More charts are needed to cover the unit two-sphere. Two such charts are the right and left hemispheres U_2^+ and U_2^- , for which $y > 0$ and $y < 0$, respectively. However, these two neighborhoods leave two points uncovered, the points $(1, 0, 0)$ and $(-1, 0, 0)$. Again this is because boundaries of the right and left hemispheres must be excluded. Adding the front and back hemispheres U_1^\pm to the collection covers these two points. Then S^2 is completely covered and we have an atlas. There is, of course, a lot of overlap among charts. We now show that these overlaps are C^∞ -related.

Construction of an atlas for the sphere S^2 .

As an illustration, we consider the overlap between U_3^+ and U_2^+ . This is the upper-right quarter of the sphere. Let (U_3^+, φ_3) and (U_2^+, φ_2) be charts with

$$\varphi_3(x, y, z) = (x, y), \quad \varphi_2(x, y, z) = (x, z).$$

The inverses are therefore given by

$$\varphi_3^{-1}(x, y) = (x, y, z) = (x, y, \sqrt{1 - x^2 - y^2}),$$

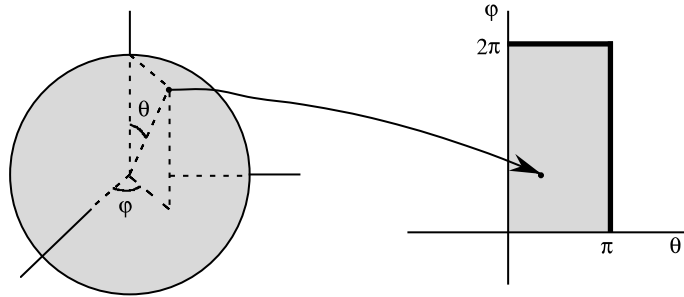

Fig. 28.2 A chart mapping points of S^2 into \mathbb{R}^2 . Note that the map is not defined for $\theta = 0, \pi$, and therefore at least one more chart is required to cover the whole sphere

$$\varphi_2^{-1}(x, z) = (x, y, z) = (x, \sqrt{1 - x^2 - z^2}, z),$$

and

$$\varphi_2 \circ \varphi_3^{-1}(x, y) = \varphi_2(x, y, \sqrt{1 - x^2 - y^2}) = (x, \sqrt{1 - x^2 - y^2}).$$

Let us denote $\varphi_2 \circ \varphi_3^{-1}$ by F , so that $F : \mathbb{R}^2 \rightarrow \mathbb{R}^2$ is described by two functions, the components of F :

$$F_1(x, y) = x \quad \text{and} \quad F_2(x, y) = \sqrt{1 - x^2 - y^2}.$$

The first component has derivatives of all orders at all points. The second component has derivatives of all orders at all points except at $x^2 + y^2 = 1$, which is excluded from the region of overlap of U_3^+ and U_2^+ , for which z can never be zero. Thus, F has derivatives of all orders at all points of its domain of definition.

One can similarly show that all regions of overlap for all charts have this property, i.e., all charts are C^∞ -related.

Example 28.1.4 For S^2 of the preceding example, we can find a new atlas in terms of new coordinate functions. Since $x_1^2 + x_2^2 + x_3^2 = 1$, we can use spherical coordinates $\theta = \cos^{-1} x_3$, $\varphi = \tan^{-1}(x_2/x_1)$. A chart is then given by $(S^2 - \{1\} - \{-1\}, \mu)$, where $\mu(P) = (\theta, \varphi)$ maps a point of S^2 onto a region in \mathbb{R}^2 . This is schematically shown in Fig. 28.2. The singletons $\{1\}$ and $\{-1\}$ are the north and the south poles, respectively.

This chart cannot cover all of S^2 , however, because when $\theta = 0$ (or π), the value of the azimuthal angle φ is not determined. In other words, $\theta = 0$ (or π) determines *one* point of the sphere (the north pole or the south pole), but its image in \mathbb{R}^2 is the whole range of φ values. Therefore, we must exclude $\theta = 0$ (or π) from the chart (S^2, μ) . To cover these two points, we need more charts.

illustration of
stereographic projection

Example 28.1.5 A third atlas for S^2 is the so-called **stereographic projection** shown in Fig. 28.3. In such a mapping the image of a point is obtained by drawing a line from the north pole to that point and extending it, if necessary, until it intersects the x_1x_2 -plane. It can be verified that the mapping

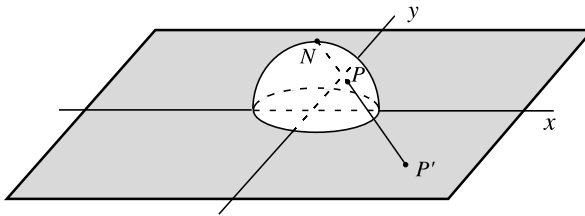

Fig. 28.3 Stereographic projection of S^2 into R^2 . Note that the north pole has no image under this map; another chart is needed to cover the whole sphere

$\varphi : S^2 - \{1\} \rightarrow \mathbb{R}^2$ is given by

$$\varphi(x_1, x_2, x_3) = \left(\frac{x_1}{1 - x_3}, \frac{x_2}{1 - x_3} \right).$$

We see that this mapping fails for $x_3 = 1$, that is, the north pole. Therefore, the north pole must be excluded (thus, the domain $S^2 - \{1\}$). To cover the north pole we need another stereographic projection—this time from the south pole. Then the two mappings will cover all of S^2 , and it can be shown that the two charts are C^∞ -related (see Example 28.1.12).

The three foregoing examples illustrate the following fact, which can be shown to hold rigorously:

Box 28.1.6 *It is impossible to cover the whole S^2 with just one chart.*

Example 28.1.7 Let \mathcal{V} be an m -dimensional real vector space. Fix any basis $\{e_i\}$ in \mathcal{V} with dual basis $\{\epsilon^i\}$. Define $\phi : \mathcal{V} \rightarrow \mathbb{R}^m$ by $\phi(\mathbf{v}) = (\epsilon^1(\mathbf{v}), \dots, \epsilon^m(\mathbf{v}))$. Then the reader may verify that (\mathcal{V}, ϕ) is an atlas. Linearity of ϕ ensures that it has derivatives of all orders. This construction shows that \mathcal{V} is a manifold of dimension m .

vector spaces are manifolds

If M and N are manifolds of dimensions m and n , respectively, we can construct their **product manifold** $M \times N$, a manifold of dimension $m + n$. A typical chart on $M \times N$ is obtained from charts on M and N as follows. Let (U, φ) be a chart on M and (V, μ) one on N . Then a chart on $M \times N$ is $(U \times V, \varphi \times \mu)$ where

product manifold defined

$$\varphi \times \mu(P, Q) = (\varphi(P), \mu(Q)) \in \mathbb{R}^m \times \mathbb{R}^n = \mathbb{R}^{m+n} \quad \text{for } P \in U, Q \in V.$$

Definition 28.1.8 Let M be a manifold. A subset N of M is called a **submanifold** of M if N is a manifold in its own right.

submanifold

A trivial, but important, example of submanifolds is the so-called **open submanifold**. If M is a manifold and U is an open subset¹ of M , then U

open submanifolds

¹Recall that an open subset U is one each of whose points is the center of an open ball lying entirely in U .

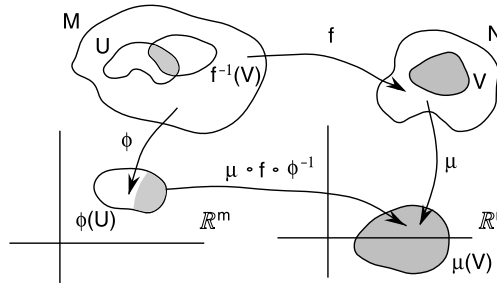

Fig. 28.4 Corresponding to every map $f : M \rightarrow N$ there exists a coordinate map $\mu \circ f \circ \phi^{-1} : \mathbb{R}^m \rightarrow \mathbb{R}^n$

inherits a manifold structure from M by taking any chart $(U_\alpha, \varphi_\alpha)$ and restricting φ_α to $U \cap U_\alpha$. It is clear that $\dim U = \dim M$.

Having gained familiarity with manifolds, it is now appropriate to consider maps between them that are compatible with their structure.

Definition 28.1.9 Let M and N be manifolds of dimensions m and n , respectively. Let $f : M \rightarrow N$ be a map. We say that f is \mathcal{C}^∞ , or **differentiable**, if for every chart (U, φ) in M and every chart (V, μ) in N , the composite map $\mu \circ f \circ \varphi^{-1} : \mathbb{R}^m \rightarrow \mathbb{R}^n$, called the **coordinate expression for f** , is \mathcal{C}^∞ wherever it is defined.²

The content of this definition is illustrated in Fig. 28.4. A particularly important special case occurs when $N = \mathbb{R}$; then we call f a (real-valued) **function**. The collection of all \mathcal{C}^∞ functions at a point $P \in M$ is denoted by $F^\infty(P)$: If $f \in F^\infty(P)$, then $f : U_P \rightarrow \mathbb{R}$ is \mathcal{C}^∞ for some neighborhood U_P of P .

Let $f : M \rightarrow N$ be a differentiable map. Then f is automatically continuous. Now let V be an open subset of N . The set $f^{-1}(V)$ is an open subset of M by Proposition 17.4.6.³

Proposition 28.1.10 Let M be an m -dimensional manifold, $f : M \rightarrow N$ a differentiable map, and V an open subset of N . Then $f^{-1}(V)$, the set of points of M mapped onto V , is an open m -dimensional submanifold of M .

Just as the concept of isomorphism identified all vector spaces, algebras, and groups that were equivalent to one another, it is desirable to introduce a notion that brings together those manifolds that “look alike”.

²The domain of $\mu \circ f \circ \varphi^{-1}$ is not all of \mathbb{R}^m , but only its open subset $\varphi(U)$. However, we shall continue to abuse the notation and write \mathbb{R}^m instead of $\varphi(U)$. This way, we do not have to constantly change the domain as U changes. The domain is always clear from the context.

³Although Proposition 17.4.6 was shown for normed linear spaces, it really holds for all “spaces” for which the concept of open set is defined.

Definition 28.1.11 A bijective differentiable map whose inverse is also differentiable is called a **diffeomorphism**. Two manifolds between which a diffeomorphism exists are called **diffeomorphic**. Let M and N be manifolds. M is said to be **diffeomorphic to N at $P \in M$** if there is a neighborhood U of P and a diffeomorphism $f : U \rightarrow f(U)$. Then f is called a **local diffeomorphism at P** .

diffeomorphism and local diffeomorphism defined

In our discussion of groups, we saw that the set of linear isomorphisms of a vector space \mathcal{V} onto itself forms a group $GL(\mathcal{V})$. The set of diffeomorphisms of a manifold M onto itself also forms a group, which is denoted by $\text{Diff}(M)$.

diffeomorphisms of a manifold form a group

Example 28.1.12 The generalization of a sphere is the unit n -sphere, which is a subset of \mathbb{R}^{n+1} defined by

n -sphere and its stereographic projection

$$S^n = \{(x_1, \dots, x_{n+1}) \in \mathbb{R}^{n+1} \mid x_1^2 + \dots + x_{n+1}^2 = 1\}.$$

The stereographic projection defines an atlas for S^n as follows. For all points of S^n except $(0, 0, \dots, 1)$, the north pole, define the chart $\varphi_+ : S^n - \{1\} \equiv U^+ \rightarrow \mathbb{R}^n$ by

$$\begin{aligned} \varphi_+(x_1, \dots, x_{n+1}) \\ = \left(\frac{x_1}{1 - x_{n+1}}, \dots, \frac{x_n}{1 - x_{n+1}} \right) \quad \text{for } (x_1, \dots, x_{n+1}) \in U^+. \end{aligned}$$

To include the north pole, consider a second chart $\varphi_- : S^n - \{-1\} \equiv U^- \rightarrow \mathbb{R}^n$ defined by

$$\begin{aligned} \varphi_-(x_1, \dots, x_{n+1}) \\ = \left(\frac{x_1}{1 + x_{n+1}}, \dots, \frac{x_n}{1 + x_{n+1}} \right) \quad \text{for } (x_1, \dots, x_{n+1}) \in U^-. \end{aligned}$$

Next, let us find the inverses of these maps. We find the inverse of φ_+ ; that of φ_- can be found similarly. Let $\xi_k \equiv x_k / (1 - x_{n+1})$. Then one can readily show that

$$\sum_{k=1}^n \xi_k^2 = \frac{1 + x_{n+1}}{1 - x_{n+1}} \Rightarrow x_{n+1} = \frac{\sum_{k=1}^n \xi_k^2 - 1}{\sum_{k=1}^n \xi_k^2 + 1}$$

and

$$x_i = \frac{2\xi_i}{1 + \sum_{k=1}^n \xi_k^2} \quad \text{for } i = 1, 2, \dots, n.$$

From the definition of φ_+ , we have

$$\begin{aligned} \varphi_+^{-1}(\xi_1, \dots, \xi_n) &= (x_1, \dots, x_n, x_{n+1}) \\ &= \left(\frac{2\xi_1}{1 + \sum_{k=1}^n \xi_k^2}, \dots, \frac{2\xi_n}{1 + \sum_{k=1}^n \xi_k^2}, \frac{\sum_{k=1}^n \xi_k^2 - 1}{\sum_{k=1}^n \xi_k^2 + 1} \right). \end{aligned} \tag{28.1}$$

On the overlap of U^+ and U^- , i.e., on all points of S^n except the north and the south poles, $\varphi_- \circ \varphi_+^{-1} : \mathbb{R}^n \rightarrow \mathbb{R}^n$ can be calculated by noting that φ_- has the following effect on a typical entry of Eq. (28.1):

$$x_j \mapsto \frac{x_j}{1 + x_{n+1}} = \frac{\frac{2\xi_j}{1 + \sum_{k=1}^n \xi_k^2}}{1 + \frac{\sum_{k=1}^n \xi_k^2 - 1}{\sum_{k=1}^n \xi_k^2 + 1}} = \frac{\xi_j}{\sum_{k=1}^n \xi_k^2}.$$

Therefore,

$$\varphi_- \circ \varphi_+^{-1}(\xi_1, \dots, \xi_n) = \left(\frac{\xi_1}{\sum_{k=1}^n \xi_k^2}, \dots, \frac{\xi_n}{\sum_{k=1}^n \xi_k^2} \right).$$

It is clear that $\varphi_- \circ \varphi_+^{-1}$ has derivatives of all orders except possibly at a point for which $\xi_i = 0$ for all i . But this would correspond to $x_{n+1} = 1$, which is excluded from the region of overlap.

28.2 Curves and Tangent Vectors

We noted above that *functions* are special cases of Definition 28.1.9. Another special case occurs when $M = \mathbb{R}$. This is important enough to warrant a separate definition.

Definition 28.2.1 A **differentiable curve** in the manifold M is a \mathcal{C}^∞ map of an interval of \mathbb{R} to M .

This definition should be familiar from calculus, where $M = \mathbb{R}^3$ and a curve is given by its *parametric equation* $(f_1(t), f_2(t), f_3(t))$, or simply by $\mathbf{r}(t)$. The point $\gamma(a) \in M$ is called the **initial point**, and $\gamma(b) \in M$ is called the **final point** of the curve γ . A curve is closed if $\gamma(a) = \gamma(b)$.

We are now ready to consider what a vector at a point is. All the familiar vectors in classical physics, such as displacement, velocity, momentum, and so forth, are based on the displacement vector. Let us see how we can generalize such a vector so that it is compatible with the concept of a manifold.

In \mathbb{R}^2 , we define the displacement vector from P to Q as a directed straight line that starts at P and ends at Q . Furthermore, the direction of the vector remains the same if we connect P to any other final point on the line PQ located beyond Q . This is because \mathbb{R}^2 is a flat space, a straight line is well-defined, and there is no ambiguity in the direction of the vector from P to Q .

Things change, however, if we move to a two-dimensional spherical surface such as the globe. How do we define the straight line from New York to Beijing? There is no satisfactory definition of the word “straight” on a curved surface. Let us say that “straight” means shortest distance. Then our shortest path would lie on a great circle passing through New York and Beijing. Define the “direction” of the trip as the “straight” arrow, say 1 km in length, connecting our present position to the next point 1 km away. As we

move from New York to Beijing, going westward, the tip of the arrow keeps changing direction. Its direction in New York is slightly different from its direction in Chicago. In San Francisco the direction is changed even more, and by the time we reach Beijing, the tip of the arrow will be almost opposite to its original direction.

The reason for such a changing arrow is, of course, the curvature of the manifold. We can minimize this curvature effect if we do not go too far from New York. If we stay close to New York, the surface of the earth appears flat, and we can draw arrows between points. The closer the two points, the better the approximation to flatness. Clearly, the concept of a vector is a *local* concept, and the process of constructing a vector is a *limiting* process.

The limiting process in the globe example entailed the notions of “closeness”. Such a notion requires the concept of distance, which is natural for a globe but not necessary for a general manifold. For most manifolds it is possible to define a metric that gives the “distance” between two points of the manifold. However, the concept of a vector is too general to require such an elaborate structure as a metric. The abstract usefulness of a metric is a result of its real-valuedness: given two points P_1 and P_2 , the distance between them, $d(P_1, P_2)$, is a nonnegative real number. Thus, distances between different points can be compared.

We have already defined two concepts for manifolds (more basic than the concept of a metric) that together can replace the concept of a metric in defining a vector as a limit. These are the concepts of (real-valued) functions and curves. Let us see how functions and curves can replace metrics.

Let $\gamma : [a, b] \rightarrow M$ be a curve in the manifold M . Let $P \in M$ be a point of M that lies on γ such that $\gamma(c) = P$ for some $c \in [a, b]$. Let $f \in F^\infty(P)$. Restrict f to the neighboring points of P that lie on γ . Then the composite function $f \circ \gamma : \mathbb{R} \rightarrow \mathbb{R}$ is a real-valued function on \mathbb{R} .

We can compare values of $f \circ \gamma$ for various real numbers close to c —as in calculus. If $u \in [a, b]$ denotes⁴ the variable, then $f \circ \gamma(u) = f(\gamma(u))$ gives the value of $f \circ \gamma$ at various u 's. In particular, the difference $\Delta(f \circ \gamma) \equiv f(\gamma(u)) - f(\gamma(c))$ is a measure of how close the point $\gamma(u) \in M$ is to P . Going one step further, we define

$$\left. \frac{d(f \circ \gamma)}{du} \right|_{u=c} = \lim_{u \rightarrow c} \frac{f(\gamma(u)) - f(\gamma(c))}{u - c}, \quad (28.2)$$

the usual derivative of an ordinary function of one variable. However, this derivative depends on γ and on the point P . The function f is merely a *test function*. We could choose any other function to test how things change with movement along γ . What is important is not which function we choose, but how the curve γ causes it to change with movement along γ away from P . This change is determined by the directional derivative along γ at P , as given by (28.2). A directional derivative determines a tangent which, in turn, suggests a tangent *vector*. That is why the tangent vector at P along γ is defined to be the directional derivative itself!

⁴We usually use u or t to denote the (real) argument of the map $\gamma : [a, b] \rightarrow M$.

The use of derivative as tangent vector may appear strange to the novice, especially physicists encountering it for the first time, but it has been familiar to mathematicians for a long time. It is hard for the beginner to imagine vectors being charged with the responsibility of measuring the rate of change of functions. It takes some mental adjustment to get used to this idea. The following simple illustration may help with establishing the vector-derivative connection.

illustration of the equality of vectors and directional derivatives

Example 28.2.2 Let us take the familiar case of a plane and consider the vector $\mathbf{a} = a_x \hat{\mathbf{e}}_x + a_y \hat{\mathbf{e}}_y$. What kind of a directional derivative can correspond to \mathbf{a} ? First we need a curve $\gamma : \mathbb{R} \rightarrow \mathbb{R}^2$ that is somehow associated with \mathbf{a} . It is not hard to convince oneself that the most natural association is that of vectors to tangents. Thus, we seek a curve whose tangent is (parallel to) \mathbf{a} . The easiest (but not the only) way is simply to take the straight line along \mathbf{a} ; that is, let $\gamma(u) = (a_x u, a_y u)$. The directional derivative at $u = 0$ for an arbitrary function $f : \mathbb{R}^2 \rightarrow \mathbb{R}$ is given by

$$\left. \frac{d(f \circ \gamma)}{du} \right|_{u=0} = \lim_{u \rightarrow 0} \frac{f(\gamma(u)) - f(\gamma(0))}{u} = \lim_{u \rightarrow 0} \frac{f(a_x u, a_y u) - f(0, 0)}{u}. \quad (28.3)$$

Taylor expansion in two dimensions yields

$$f(a_x u, a_y u) = f(0, 0) + a_x u \left. \frac{\partial f}{\partial x} \right|_{u=0} + a_y u \left. \frac{\partial f}{\partial y} \right|_{u=0} + \dots$$

Substituting in (28.3), we obtain

$$\begin{aligned} \left. \frac{d(f \circ \gamma)}{du} \right|_{u=0} &= \lim_{u \rightarrow 0} \frac{a_x u (\partial f / \partial x)_{u=0} + a_y u (\partial f / \partial y)_{u=0} + \dots}{u} \\ &= a_x \frac{\partial f}{\partial x} + a_y \frac{\partial f}{\partial y} = \left(a_x \frac{\partial}{\partial x} + a_y \frac{\partial}{\partial y} \right) f. \end{aligned}$$

This clearly shows the connection between directional derivatives and vectors. In fact, the correspondences $\partial / \partial x \leftrightarrow \hat{\mathbf{e}}_x$ and $\partial / \partial y \leftrightarrow \hat{\mathbf{e}}_y$ establish this connection very naturally.

Note that the curve γ chosen above is by no means unique. In fact, there are infinitely many curves that have the same tangent at $u = 0$ and give the same directional derivative.

Since vectors are the same as derivatives, we expect them to have the properties shared by derivatives:

tangent vector defined

Definition 28.2.3 Let M be a differentiable manifold. A **tangent vector** at $P \in M$ is an operator $\mathbf{t} : F^\infty(P) \rightarrow \mathbb{R}$ such that for every $f, g \in F^\infty(P)$ and $\alpha, \beta \in \mathbb{R}$

1. \mathbf{t} is linear: $\mathbf{t}(\alpha f + \beta g) = \alpha \mathbf{t}(f) + \beta \mathbf{t}(g)$;
2. \mathbf{t} satisfies the **derivation property**:

derivation property of tangent vectors

$$\mathbf{t}(fg) = g(P)\mathbf{t}(f) + f(P)\mathbf{t}(g).$$

The operator \mathbf{t} is an abstraction of the derivative operator. Note that $\mathbf{t}(f)$, $g(P)$, $f(P)$, and $\mathbf{t}(g)$ are all real numbers.

The reader may easily check that if addition and scalar multiplication of tangent vectors are defined in an obvious way, the set of all tangent vectors at $P \in M$ becomes a vector space, called the **tangent space** at P and denoted by $\mathcal{T}_P(M)$. If U is an open subset of M (therefore, an open submanifold of M), then it is clear that tangent space defined

$$\mathcal{T}_P(U) = \mathcal{T}_P(M) \quad \text{for all } P \in U. \tag{28.4}$$

Definition 28.2.3 was motivated by Eqs. (28.2) and (28.3). Let us go backwards and see if (28.2) is indeed a tangent, that is, if it satisfies the two conditions of Definition 28.2.3.

Proposition 28.2.4 *Let γ be a C^∞ curve in M such that $\gamma(c) = P$. Define $\vec{\gamma}(c) : F^\infty(P) \rightarrow \mathbb{R}$ by* vectors tangent to a curve

$$(\vec{\gamma}(c))(f) \equiv \left. \frac{d}{du} f \circ \gamma \right|_{u=c}, \quad f \in F^\infty(P).$$

Then $\vec{\gamma}(c)$ is a tangent vector at P called the vector **tangent to γ at c** .

Proof We have to show that the two conditions of Definition 28.2.3 are satisfied for $f, g \in F^\infty(P)$ and $\alpha, \beta \in \mathbb{R}$. The first condition is trivial. For the second condition, we use the product rule for ordinary differentiation as follows:

$$\begin{aligned} (\vec{\gamma}(c))(fg) &= \left. \frac{d}{du} (fg) \circ \gamma \right|_{u=c} \equiv \left. \frac{d}{du} [(f \circ \gamma)(g \circ \gamma)] \right|_{u=c} \\ &= \left[\left. \frac{d}{du} (f \circ \gamma) \right|_{u=c} \right] (g \circ \gamma)_{u=c} + (f \circ \gamma)_{u=c} \left[\left. \frac{d}{du} (g \circ \gamma) \right|_{u=c} \right] \\ &= [(\vec{\gamma}(c))(f)]g(\gamma(c)) + f(\gamma(c))[(\vec{\gamma}(c))(g)] \\ &= [(\vec{\gamma}(c))(f)]g(P) + f(P)[(\vec{\gamma}(c))(g)]. \end{aligned}$$

Note that in going from the first equality to the second, we used the fact that by definition, the product of two functions evaluated at a point is the product of the values of the two functions at that point. □

Let us now consider a special curve and corresponding tangent vector that is of extreme importance in applications. Let $\varphi = (x^1, x^2, \dots, x^m)$ be a coordinate system at P , where $x^i : M \rightarrow \mathbb{R}$ is the i th coordinate function. Then φ is a bijective C^∞ mapping from the manifold M into \mathbb{R}^m . Its inverse, $\varphi^{-1} : \mathbb{R}^m \rightarrow M$, is also a C^∞ mapping. Now, the i th coordinate of P is the real number $u \equiv x^i(P)$. Suppose that all coordinates of P are held fixed except the i th one, which is allowed to vary with u describing this variation.

Definition 28.2.5 Let (U_P, φ) be a chart at $P \in M$. Then the curve $\gamma^i : \mathbb{R} \rightarrow M$, defined by

$$\gamma^i(u) = \varphi^{-1}(x^1(P), \dots, x^{i-1}(P), u, x^{i+1}(P), \dots, x^m(P))$$

coordinate curve, is called the i th **coordinate curve** through P . The tangent vector to this coordinate vector field, curve at P is denoted by $\partial_i|_P$ and is called the i th **coordinate vector field** and coordinate frames at P . The collection of all vector fields at P is called a **coordinate frame** at P . The variable u is arbitrary in the sense that it can be replaced by any (good) function of u .

Let $c = x^i(P)$. Then for $f \in F^\infty(P)$, we have

$$\begin{aligned} (\partial_i|_P)f &= (\vec{\gamma}_i(c))(f) = \left. \frac{d}{du} f \circ \gamma^i \right|_{u=c} \\ &= \left. \frac{d}{du} f(\varphi^{-1}(x^1(P), \dots, x^{i-1}(P), u, x^{i+1}(P), \dots, x^m(P))) \right|_{u=c} \\ &\equiv \left. \frac{\partial f}{\partial x^i} \right|_P \Rightarrow \partial_i|_P = \left. \frac{\partial}{\partial x^i} \right|_P, \end{aligned} \quad (28.5)$$

where the last equality is a (natural) *definition* of the partial derivative of f with respect to the i th coordinate evaluated at the point P . This partial derivative is again a C^∞ function at P . We therefore have the following:

Proposition 28.2.6 *The coordinate frame $\{\partial_i|_P\}_{i=1}^m$ at P is a set of operators $\partial_i(P) : F^\infty(P) \rightarrow \mathbb{R}$ given by*

$$\begin{aligned} (\partial_i|_P)f &= \left. \frac{\partial f}{\partial x^i} \right|_P \\ &\equiv \left. \frac{d}{du} f(\varphi^{-1}(x^1(P), \dots, x^{i-1}(P), u, x^{i+1}(P), \dots, x^m(P))) \right|_{u=c}. \end{aligned} \quad (28.6)$$

Another common notation for $\partial f/\partial x^i$ is $f_{,i}$

Example 28.2.7 Pick a point $P = (\sin\theta \cos\varphi, \sin\theta \sin\varphi, \cos\theta)$ on the sphere S^2 in a chart (U_P, μ) given by $\mu(\sin\theta \cos\varphi, \sin\theta \sin\varphi, \cos\theta) = (\theta, \varphi)$. If θ is kept constant and φ is allowed to vary over values given by u , then the coordinate curve associated with φ is given by

$$\gamma_\varphi(u) = \mu^{-1}(\theta, u) = (\sin\theta \cos u, \sin\theta \sin u, \cos\theta).$$

As u varies, $\gamma_\varphi(u)$ describes a curve on S^2 . This curve is simply a circle of radius $\sin\theta$. The tangent to this curve at any point is $\partial/\partial\varphi$, or simply ∂_φ , the derivative with respect to the coordinate φ .

Similarly, the curve $\gamma_\theta(u)$ describes a great circle on S^2 with tangent $\partial_\theta \equiv \partial/\partial\theta$.

The vector space $\mathcal{T}_P(M)$ of all tangents at P was mentioned earlier. In the case of S^2 this tangent space is simply a plane tangent to the sphere at a point. Also, the two vectors, ∂_θ and ∂_φ encountered in Example 28.2.7 are clearly linearly independent. Thus, they form a basis for the tangent plane. This argument can be generalized to any manifold. The following theorem is such a generalization (for a proof, see [Bish 80, pp. 51–53]):

Theorem 28.2.8 *Let M be an m -dimensional manifold and $P \in M$. Then the set $\{\partial_i|_P\}_{i=1}^m$ forms a basis of $\mathcal{T}_P(M)$. In particular, $\mathcal{T}_P(M)$ is m -dimensional. An arbitrary vector, $\mathbf{t} \in \mathcal{T}_P(M)$, can be written as*

$$\mathbf{t} = \alpha^i \partial_i|_P, \quad \text{where } \alpha^i = \mathbf{t}(x^i).$$

Remember Einstein's summation convention!

The last statement can be derived by letting both sides operate on x^j and using Eq. (28.6). Let $M = \mathcal{V}$, a vector space. Choose a basis $\{\mathbf{e}_i\}$ in \mathcal{V} with its dual considered as coordinate functions. Then, at every $\mathbf{v} \in \mathcal{V}$, there is a natural isomorphism $\phi : \mathcal{V} \rightarrow \mathcal{T}_{\mathbf{v}}(\mathcal{V})$ mapping a vector $\mathbf{u} = \alpha^i \mathbf{e}_i \in \mathcal{V}$ onto $\alpha^i \partial_i|_{\mathbf{v}} \in \mathcal{T}_{\mathbf{v}}(\mathcal{V})$. The reader may verify that this isomorphism is coordinate independent; i.e., if one chooses any other basis of \mathcal{V} with its corresponding dual, then $\phi(\mathbf{v})$ will be the same vector as before, expressed in the new coordinate basis. Thus,

Box 28.2.9 *If \mathcal{V} is a vector space, then for all $\mathbf{v} \in \mathcal{V}$, one can identify $\mathcal{T}_{\mathbf{v}}(\mathcal{V})$ with \mathcal{V} itself.*

Suppose we have two coordinate systems at P , $\{x^i\}$ with tangents $\partial_i|_P$ and $\{y^j\}$ with tangents $\nabla_j|_P$. Any $\mathbf{t} \in \mathcal{T}_P(M)$ can be expressed either in terms of $\partial_i|_P$ or in terms of $\nabla_j|_P$: $\mathbf{t} = \alpha^i \partial_i|_P = \beta^j \nabla_j|_P$. We can use this relation to obtain α^i in terms of β^j : From Theorem 28.2.8, we have

$$\alpha^i = \mathbf{t}(x^i) = (\beta^j \nabla_j|_P)(x^i) \equiv \left[\beta^j \frac{\partial}{\partial y^j} \Big|_P \right] (x^i) = \beta^j \frac{\partial x^i}{\partial y^j} \Big|_P. \quad (28.7)$$

In particular, if $\mathbf{t} = \nabla_k|_P$, then $\beta^j = \mathbf{t}(y^j) = [\nabla_k|_P](y^j) = \delta_k^j$, and (28.7) gives $\alpha^i = \partial x^i / \partial y^k$. Thus, using Eq. (28.5),

$$\frac{\partial}{\partial y^j} \Big|_P = \frac{\partial x^i}{\partial y^j} \frac{\partial}{\partial x^i} \Big|_P. \quad (28.8)$$

For any function $f \in F^\infty(P)$, Eq. (28.8) yields

$$\left[\frac{\partial}{\partial y^j} \Big|_P \right] f = \frac{\partial f}{\partial y^j} \Big|_P = \frac{\partial x^i}{\partial y^j} \Big|_P \left[\frac{\partial}{\partial x^i} \Big|_P \right] f = \frac{\partial x^i}{\partial y^j} \Big|_P \frac{\partial f}{\partial x^i} \Big|_P.$$

This is the chain rule for differentiation.

Example 28.2.10 Let us find the coordinate curves and the coordinate frame at $P = (x, y, z)$ on S^2 . We use the coordinates of Example 28.1.3. In particular, consider φ_3 , whose inverse is given by

$$\varphi_3^{-1}(x, y) = (x, y, \sqrt{1 - x^2 - y^2}).$$

The coordinate curve $\gamma_2(u)$ along y is obtained by letting y be a function⁵ of u :

$$\gamma_2(u) = \varphi_3^{-1}(x, h(u)) = (x, h(u), \sqrt{1 - x^2 - h^2(u)}),$$

where $h(0) = y$ and $h'(0) = \alpha$, a constant. To find the coordinate vector field at P , let $f \in F^\infty(P)$, and note that

$$\begin{aligned} \partial_2 f &= \left. \frac{d}{du} f(\gamma_2(u)) \right|_{u=0} = \left. \frac{d}{du} f(x, h(u), \sqrt{1 - x^2 - h^2(u)}) \right|_{u=0} \\ &= \left. \frac{\partial f}{\partial y} \frac{dh}{du} \right|_{u=0} + \left. \frac{\partial f}{\partial z} \left[\frac{1}{2} (-2h(u)) \frac{dh}{du} \frac{1}{\sqrt{1 - x^2 - h^2(u)}} \right] \right|_{u=0} \\ &= \alpha \left(\frac{\partial f}{\partial y} - \frac{y}{z} \frac{\partial f}{\partial z} \right) = \alpha \left(\frac{\partial}{\partial y} - \frac{y}{z} \frac{\partial}{\partial z} \right) f. \end{aligned}$$

So, choosing the function h in such a way that $\alpha = 1$,

$$\partial_2 = \partial_y - \frac{y}{z} \partial_z,$$

where ∂_y and ∂_z are the coordinate vector fields of \mathbb{R}^3 . The coordinate vector field ∂_1 can be obtained similarly.

28.3 Differential of a Map

Now that we have constructed tangent spaces and defined bases for them, we are ready to consider the notion of the differential (derivative) of a map between manifolds.

Definition 28.3.1 Let M and N be manifolds of dimensions m and n , respectively, and let $\psi : M \rightarrow N$ be a C^∞ map. Let $P \in M$, and let $Q = \psi(P) \in N$ be the image of P . Then there is induced a map $\psi_{*P} : \mathcal{T}_P(M) \rightarrow \mathcal{T}_Q(N)$, called the **differential of ψ at P** and given as follows. Let $\mathbf{t} \in \mathcal{T}_P(M)$ and $f \in F^\infty(Q)$. The action of $\psi_{*P}(\mathbf{t}) \in \mathcal{T}_Q(N)$ on f is defined as

$$(\psi_{*P}(\mathbf{t}))(f) \equiv \mathbf{t}(f \circ \psi). \quad (28.9)$$

The reader may check that the differential of a composite map is the composite of the corresponding differentials, i.e.,

$$(\psi \circ \phi)_{*P} = \psi_{*\phi(P)} \circ \phi_{*P}. \quad (28.10)$$

Furthermore, if ψ is a local diffeomorphism at P , then ψ_{*P} is a vector space isomorphism. The inverse of this statement—which is called the **inverse mapping theorem**, and is much harder to prove (see [Abra 88, pp. 116 and 196])—is also true:

⁵See the last statement of Definition 28.2.5.

Theorem 28.3.2 (Inverse mapping theorem) *If $\psi : M \rightarrow N$ is a map and $\psi_{*P} : \mathcal{T}_P(M) \rightarrow \mathcal{T}_{\psi(P)}(N)$ is a vector space isomorphism, then ψ is a local diffeomorphism at P .* inverse mapping theorem

Let us see how Eq. (28.9) looks in terms of coordinate functions. Suppose that $\{x^i\}_{i=1}^m$ are coordinates at P and $\{y^a\}_{a=1}^n$ are coordinates at $Q = \psi(P)$. We note that $y^a \circ \psi$ is a real-valued C^∞ function on M . Thus, we may write (with the function expressed in terms of coordinates)

$$y^a \circ \psi \equiv f^a(x^1, \dots, x^m).$$

We also have $\mathbf{t} = \alpha^i \partial_i|_P$. Similarly, $\psi_{*P}(\mathbf{t}) = \beta^a (\partial/\partial y^a)|_Q$ because $\{(\partial/\partial y^a)|_Q\}$ form a basis. Theorem 28.2.8 and Definition 28.3.1 now give

$$\begin{aligned} \beta^a &= \psi_{*P}(\mathbf{t})(y^a) = \mathbf{t}(y^a \circ \psi) = \mathbf{t}(f^a) \\ &= [\alpha^i \partial_i|_P](f^a) = \alpha^i \frac{\partial f^a}{\partial x^i} \Big|_P \equiv \sum_{i=1}^m \alpha^i \frac{\partial f^a}{\partial x^i} \Big|_P. \end{aligned}$$

This can be written in matrix form as

$$\begin{pmatrix} \beta^1 \\ \beta^2 \\ \vdots \\ \beta^n \end{pmatrix} = \begin{pmatrix} \partial f^1/\partial x^1 & \partial f^1/\partial x^2 & \dots & \partial f^1/\partial x^m \\ \partial f^2/\partial x^1 & \partial f^2/\partial x^2 & \dots & \partial f^2/\partial x^m \\ \vdots & \vdots & & \vdots \\ \partial f^n/\partial x^1 & \partial f^n/\partial x^2 & \dots & \partial f^n/\partial x^m \end{pmatrix} \begin{pmatrix} \alpha^1 \\ \alpha^2 \\ \vdots \\ \alpha^m \end{pmatrix}. \tag{28.11}$$

The $n \times m$ matrix is denoted by J and is called the **Jacobian matrix** of ψ with respect to the coordinates x^i and y^a . On numerous occasions the two manifolds are simply Cartesian spaces, so that $\psi : \mathbb{R}^m \rightarrow \mathbb{R}^n$. In such a case, f^a is naturally written as ψ^a , and the Jacobian matrix will have elements of the form $\partial \psi^a / \partial x^i$. Jacobian matrix of a differentiable map

An important special case of the differential of a map is that of a constant map. Let $\psi : M \rightarrow \{Q\} \in N$ be such a map; it maps all points of M onto a single point Q of N . For any $f \in F^\infty(Q)$, the function $f \circ \psi \in F^\infty(P)$ is constant for all $P \in M$. Let $\mathbf{t} \in \mathcal{T}_P(M)$ be an arbitrary vector. Then

$$(\psi_{*P}(\mathbf{t}))(f) \equiv \mathbf{t}(f \circ \psi) = 0 \quad \forall f \Rightarrow \psi_{*P}(\mathbf{t}) = 0 \quad \forall \mathbf{t} \tag{28.12}$$

because $\mathbf{t}(c) = 0$ for any constant c . So,

Differential of a constant map is the zero map.

Box 28.3.3 *If $\psi : M \rightarrow \{Q\} \in N$ is a constant map, so that it maps the entire manifold M onto a point Q of N , then $\psi_{*P} : \mathcal{T}_P(M) \rightarrow \mathcal{T}_Q(N)$ is the zero map.*

Two other special cases merit closer attention: $M = \mathbb{R}$ for arbitrary N , and $N = \mathbb{R}$ for arbitrary M . In either case $\mathcal{T}_c(\mathbb{R})$ is one-dimensional with the basis vector $(d/du)|_c$. When $M = \mathbb{R}$, the mapping becomes a curve, $\gamma : \mathbb{R} \rightarrow N$. The only vector whose image we are interested in is $\mathbf{t} = (d/du)|_c$,

with $\gamma(c) = P$. From (28.9) using Proposition 28.2.4 in the last step, we have

$$\left[\gamma_{*c} \frac{d}{du} \Big|_c \right] f = \frac{d}{du} f \circ \gamma \Big|_{u=c} = (\tilde{\gamma}(c))(f).$$

This tells us that the differential of a curve at c is simply its tangent vector at $\gamma(c)$. It is common to leave out the constant vector $(d/du)|_c$, and write γ_{*c} for the LHS.

components of tangents to curves

Example 28.3.4 It is useful to have an expression for the components of the tangent to a curve γ at an arbitrary point on it. Since γ maps the real line to M , with a coordinate patch established on M , we can write γ as $\gamma = (\gamma^1, \dots, \gamma^m)$ where $\gamma^i = x^i \circ \gamma$ are ordinary functions of one variable. Proposition 28.2.4 then yields

$$\begin{aligned} \gamma_{*t} f &= \frac{d}{du} f \circ \gamma \Big|_{u=t} = \frac{d}{du} f(\gamma(u)) \Big|_{u=t} = \frac{d}{du} f(\gamma^1(u), \dots, \gamma^m(u)) \Big|_{u=t} \\ &= \frac{\partial f}{\partial x^i} \frac{d\gamma^i}{du} \Big|_{u=t} \equiv \frac{\partial f}{\partial x^i} \frac{d\gamma^i}{dt} = \dot{\gamma}^i \partial_i f, \end{aligned}$$

or

$$\boxed{\gamma_{*t} \equiv \dot{\gamma}^i \partial_i, \quad \text{where } \dot{\gamma}^i = \frac{d\gamma^i}{dt}.} \tag{28.13}$$

For this reason, γ_{*t} is sometimes denoted by $\dot{\gamma}$.

When $N = \mathbb{R}$, we are dealing with a real-valued function $f : M \rightarrow \mathbb{R}$. The differential of f at P is $f_{*P} : \mathcal{T}_P(M) \rightarrow \mathcal{T}_c(\mathbb{R})$, where $c = f(P)$. Since $\mathcal{T}_c(\mathbb{R})$ is one-dimensional, for a tangent $\mathbf{t} \in \mathcal{T}_P(M)$, we have $f_{*P}(\mathbf{t}) = a(d/du)|_c$. Let $g : \mathbb{R} \rightarrow \mathbb{R}$ be an arbitrary function on \mathbb{R} . Then $[f_{*P}(\mathbf{t})](g) = a(dg/du)_c$, or, by definition of the LHS, $\mathbf{t}(g \circ f) = a(dg/du)_c$. To find a we choose the function $g(u) = u$, i.e., the identity function; then $dg/du = 1$ and $\mathbf{t}(g \circ f) = \mathbf{t}(f) = a$. We thus obtain $f_{*P}(\mathbf{t}) = \mathbf{t}(f)(d/du)|_c$. Since $\mathcal{T}_c(\mathbb{R})$ is a flat one-dimensional vector space, all vectors are the same and there is no need to write $(d/du)|_c$. Thus, we define the **differential of f** , denoted by $df \equiv f_*$, as a map $df : \mathcal{T}_P(M) \rightarrow \mathbb{R}$ given by

differential of a real-valued function

$$df(\mathbf{t}) = \mathbf{t}(f). \tag{28.14}$$

In particular, if f is the coordinate function x^i and \mathbf{t} is the tangent to the j th coordinate curve $\partial_j|_P$, we obtain

$$dx^i|_P(\partial_j|_P) = [\partial_j|_P](x^i) = \frac{\partial x^i}{\partial x^j} \Big|_P = \delta_j^i. \tag{28.15}$$

This shows that

Box 28.3.5 $\{dx^i|_P\}_{i=1}^m$ is dual to the basis $\{\partial_j|_P\}_{j=1}^m$ of $\mathcal{T}_P(M)$.

Example 28.3.6 Let $f : M \rightarrow \mathbb{R}$ be a real-valued function on M . Let x^i be coordinates at P . We want to express df in terms of coordinate functions. For $\mathbf{t} \in \mathcal{T}_P(M)$ we can write $\mathbf{t} = \alpha^i \partial_i|_P$ and

Remember Einstein's summation convention!

$$df(\mathbf{t}) = \mathbf{t}(f) = \alpha^i [\partial_i|_P](f) = \alpha^i \partial_i(f),$$

where in the last step, we suppressed the P . Theorem 28.2.8 and Eq. (28.14) yield $\alpha^i = \mathbf{t}(x^i) = (dx^i)(\mathbf{t})$. We thus have

$$df(\mathbf{t}) = \partial_i(f)[(dx^i)(\mathbf{t})] = [\partial_i(f)(dx^i)](\mathbf{t}).$$

Since this is true for all \mathbf{t} , we get

$$df = \partial_i(f)(dx^i) \equiv \sum_{i=1}^m \partial_i(f)(dx^i) = \sum_{i=1}^m \frac{\partial f}{\partial x^i} dx^i. \quad (28.16)$$

This is the classical formula for the differential of a function f . If we choose y^j , the j th member of a new coordinate system, for f , we obtain

$$dy^j = \sum_{i=1}^m \frac{\partial y^j}{\partial x^i} dx^i \equiv \frac{\partial y^j}{\partial x^i} dx^i, \quad (28.17)$$

which is the transformation dual to Eq. (28.8).

Consider a map ϕ from the product manifold $M \times N$ to another manifold L . Then

$$\phi_* : \mathcal{T}_P(M) \times \mathcal{T}_Q(N) \rightarrow \mathcal{T}_{\phi(P,Q)}(L).$$

We want to find $\phi_*(\mathbf{t}, \mathbf{s})$ for $\mathbf{t} \in \mathcal{T}_P(M)$ and $\mathbf{s} \in \mathcal{T}_Q(N)$. First define the maps $\phi_Q : M \rightarrow L$ and $\phi_P : N \rightarrow L$ by $\phi_Q(P) = \phi(P, Q)$ and $\phi_P(Q) = \phi(P, Q)$. Then

$$\phi_{Q*} : \mathcal{T}_P(M) \rightarrow \mathcal{T}_{\phi(P,Q)}(L) \quad \text{and} \quad \phi_{P*} : \mathcal{T}_Q(N) \rightarrow \mathcal{T}_{\phi(P,Q)}(L).$$

Now let $\alpha(t)$ and $\beta(t)$ be the tangent curves associated with \mathbf{t} and \mathbf{s} passing through P and Q , respectively. Let $f \in F^\infty(P, Q)$. Then,

$$\begin{aligned} \phi_*(\mathbf{t}, \mathbf{s})(f) &= \frac{d}{dt} [(f \circ \phi)(\alpha(t), \beta(t))]_{t=0} \\ &= \frac{d}{dt} [(f \circ \phi)(\alpha(t), \beta(0))]_{t=0} + \frac{d}{dt} [(f \circ \phi)(\alpha(0), \beta(t))]_{t=0} \\ &= \frac{d}{dt} [(f \circ \phi)(\alpha(t), Q)]_{t=0} + \frac{d}{dt} [(f \circ \phi)(P, \beta(t))]_{t=0} \end{aligned}$$

where the second line follows from the chain rule (or partial derivatives) and the third line from the fact that α passes through P and β through Q . From the definitions of ϕ_P and ϕ_Q , we can rewrite the last line as

$$\begin{aligned} \phi_*(\mathbf{t}, \mathbf{s})(f) &= \frac{d}{dt} [(f \circ \phi_Q)(\alpha(t))]_{t=0} + \frac{d}{dt} [(f \circ \phi_P)(\beta(t))]_{t=0} \\ &\equiv \phi_{Q*}(\mathbf{t})f + \phi_{P*}(\mathbf{s})f. \end{aligned}$$

We thus have the following:

Proposition 28.3.7 *The differential of $\phi : M \times N \rightarrow L$ at (P, Q) is a map $\phi_* : \mathcal{T}_P(M) \times \mathcal{T}_Q(N) \rightarrow \mathcal{T}_{\phi(P, Q)}(L)$ given by $\phi_*(\mathbf{t}, \mathbf{s}) = \phi_{Q*}(\mathbf{t}) + \phi_{P*}(\mathbf{s})$, where $\phi_Q : M \rightarrow L$ and $\phi_P : N \rightarrow L$ are defined by $\phi_Q(P) = \phi(P, Q) = \phi_P(Q)$.*

The following is a powerful theorem that constructs a submanifold out of a differentiable map (for a proof, see [Warn 83, p. 31]):

Theorem 28.3.8 *Assume that $\psi : M \rightarrow N$ is a \mathcal{C}^∞ map, that Q is a point in the range of ψ , and that $\psi_* : \mathcal{T}_P(M) \rightarrow \mathcal{T}_Q(N)$ is surjective for all $P \in \psi^{-1}(Q)$. Then $\psi^{-1}(Q)$ is a submanifold of M and $\dim \psi^{-1}(Q) = \dim M - \dim N$.*

Compare this theorem with Proposition 28.1.10. There, V was an open subset of N , and since $f^{-1}(V)$ is open, it is automatically an *open* submanifold. The difficulty in proving Theorem 28.3.8 lies in the fact that $\psi^{-1}(Q)$ is *closed* because $\{Q\}$, a single point of N , is closed.

We can justify the last statement of the theorem as follows. From Eq. (28.12), we readily conclude that $\mathcal{T}_P(\psi^{-1}(Q)) = \ker \psi_{*P}$. The dimension theorem, applied to $\psi_{*P} : \mathcal{T}_P(M) \rightarrow \mathcal{T}_Q(N)$, now gives

$$\begin{aligned} \dim \mathcal{T}_P(M) &= \dim \ker \psi_{*P} + \text{rank } \psi_{*P} \\ \Rightarrow \dim M &= \dim \psi^{-1}(Q) + \dim N, \end{aligned}$$

where the last equality follows from the surjectivity of ψ_{*P} .

Example 28.3.9 Consider a \mathcal{C}^∞ map $f : \mathbb{R}^n \rightarrow \mathbb{R}$. Let $c \in \mathbb{R}$ such that the partial derivatives of f are defined and not all zero for all points of $f^{-1}(c)$. Then, according to Eq. (28.11), a vector $\alpha^i \partial_i \in \mathcal{T}_P(\mathbb{R}^n)$ is mapped by f_* to the vector $\alpha^i (\partial f / \partial x^i)_{f=c} d/dt$. Since $\partial f / \partial x^i$ are not all zero, by properly choosing α^i , we can make $\alpha^i (\partial f / \partial x^i)_{f=c} d/dt$ sweep over all real numbers. Therefore, f_* is surjective, and by Theorem 28.3.8, $f^{-1}(c)$ is an $(n - 1)$ -dimensional submanifold of \mathbb{R}^n . A noteworthy special case is the function defined by

$$f(x^1, x^2, \dots, x^n) = (x^1)^2 + (x^2)^2 + \dots + (x^n)^2$$

and $c = r^2 > 0$. Then, $f^{-1}(c)$, an $(n - 1)$ -sphere of radius r , is a submanifold of \mathbb{R}^n .

28.4 Tensor Fields on Manifolds

So far we have studied vector spaces, learned how to construct tensors out of vectors, touched on manifolds (the abstraction of spaces), seen how to construct vectors at a single point in a manifold by the use of the tangent-at-a-curve idea, and even found the dual vectors $dx^i|_P$ to the coordinate

vectors $\partial_i|_P$ at a point P of a manifold. We have everything we need to study the analysis of tensors.

28.4.1 Vector Fields

We are familiar with the concept of a vector field in 3D: Electric field, magnetic field, gravitational field, velocity field, and so forth are all familiar notions. We now want to generalize the concept so that it is applicable to a general manifold. To begin with, let us consider the following definition.

Definition 28.4.1 The union of all tangent spaces at different points of a manifold M is denoted by $T(M)$ and called the **tangent bundle** of M : tangent bundle defined

$$T(M) = \bigcup_{P \in M} \mathcal{T}_P(M)$$

It can be shown ([Bish 80, pp. 158–164]) that $T(M)$ is a *manifold* of dimension $2 \dim M$.

Definition 28.4.2 A **vector field** \mathbf{X} on a subset U of a manifold M is a mapping $\mathbf{X} : U \rightarrow T(M)$ such that $\mathbf{X}(P) \equiv \mathbf{X}|_P \equiv \mathbf{X}_P \in \mathcal{T}_P(M)$. The set of vector fields on M is denoted by $\mathcal{X}(M)$. Let M and N be manifolds vector field defined

and $F : M \rightarrow N$ a differentiable map. We say that the two vector fields $\mathbf{X} \in \mathcal{X}(M)$ and $\mathbf{Y} \in \mathcal{X}(N)$ are **F -related** if $F_*(\mathbf{X}_P) = \mathbf{Y}_{F(P)}$ for all $P \in M$. This is sometimes written simply as $F_*\mathbf{X} = \mathbf{Y}$. vector fields related by a map

It is worthwhile to point out that $F_*\mathbf{X}$ is not, in general, a vector field on N . To be a vector field, $F_*\mathbf{X}$ must be defined at all points of N . The natural way to define $F_*\mathbf{X}$ at $Q \in N$ is $[F_*\mathbf{X}(Q)](f) = \mathbf{X}(f \circ F)(P)$ where P is the preimage of Q , i.e., $F(P) = Q$. But there may not exist any such P (F may not be onto), or there may be more than one P (F may not be one-to-one) with such property. Therefore, this natural construction does not lead to a vector field on N . If $F_*\mathbf{X}$ happens to be a vector field on N , then it is clearly F -related to \mathbf{X} . In terms of the coordinates x^i , at each point $P \in M$,

$$\mathbf{X}_P \equiv \mathbf{X}|_P = X^i_P \partial_i|_P,$$

where the real numbers X^i_P are components of \mathbf{X}_P in the basis $\{\partial_i|_P\}$. As P moves around in U , the real numbers X^i_P keep changing. Thus, we can think of X^i_P as a function of P and define the real-valued function $X^i : M \rightarrow \mathbb{R}$ by $X^i(P) \equiv X^i_P$. Therefore, the components of a vector field are real-valued functions on M .

Example 28.4.3 Let $M = \mathbb{R}^3$. At each point $P = (x, y, z) \in \mathbb{R}^3$, let $(\hat{\mathbf{e}}_x, \hat{\mathbf{e}}_y, \hat{\mathbf{e}}_z)$ be a basis for \mathbb{R}^3 . Let \mathcal{V}_P be the vector space at P . Then $T(\mathbb{R}^3)$ is the collection of all vector spaces \mathcal{V}_P for all P .

We can determine the value of an electric field at a point in \mathbb{R}^3 by first specifying the point, as $P_0 = (x_0, y_0, z_0)$, for example. This uniquely determines the tangent space $\mathcal{T}_{P_0}(\mathbb{R}^3)$. Once we have the vector space, we

can ask what the components of the electric field are in that space. These components are given by three numbers: $E_x(x_0, y_0, z_0)$, $E_y(x_0, y_0, z_0)$, and $E_z(x_0, y_0, z_0)$. The argument is the same for any other vector field.

To specify a “point” in $T(\mathbb{R}^3)$, we need three numbers to determine the location in \mathbb{R}^3 and another three numbers to determine the components of a vector field at that point. Thus, a “point” in $T(\mathbb{R}^3)$ is given by six “coordinates” (x, y, z, E_x, E_y, E_z) , and $T(\mathbb{R}^3)$ is a six-dimensional manifold.

We know how a tangent vector \mathbf{t} at a point $P \in M$ acts on a function $f \in F^\infty(P)$ to give a real number $\mathbf{t}(f)$. We can extend this, point by point, for a vector field \mathbf{X} and define a function $\mathbf{X}(f)$ by

$$[\mathbf{X}(f)](P) \equiv \mathbf{X}_P(f), \quad P \in U, \quad (28.18)$$

where U is a subset of M on which both \mathbf{X} and f are defined. The RHS is well-defined because we know how \mathbf{X}_P , the vector at P , acts on functions at P to give the real number $[\mathbf{X}_P](f)$. On the LHS, we have $\mathbf{X}(f)$, which maps the point P onto a real number. Thus, $\mathbf{X}(f)$ is indeed a real-valued function on M . We can therefore define vector fields directly as operators on \mathcal{C}^∞ functions satisfying

$$\mathbf{X}(\alpha f + \beta g) = \alpha \mathbf{X}(f) + \beta \mathbf{X}(g),$$

$$\mathbf{X}(fg) = [\mathbf{X}(f)]g + [\mathbf{X}(g)]f.$$

\mathcal{C}^∞ vector fields

A prototypical vector field is the coordinate vector field ∂_i . In general, $\mathbf{X}(f)$ is not a \mathcal{C}^∞ function even if f is. A vector field that produces a \mathcal{C}^∞ function $\mathbf{X}(f)$ for every \mathcal{C}^∞ function f is called a \mathcal{C}^∞ **vector field**. Such a vector field has components that are \mathcal{C}^∞ functions on M .

The set of tangent vectors $\mathcal{T}_P(M)$ at a point $P \in M$ form an m -dimensional vector space. The set of vector fields $\mathcal{X}(M)$ —which yield a vector at every point of the manifold—also constitutes a vector space. However, this vector space is (uncountably) infinite-dimensional.

A property of $\mathcal{X}(M)$ that is absent in $\mathcal{T}_P(M)$ is composition.⁶ This suggests the possibility of defining a “product” on $\mathcal{X}(M)$ to turn it into an algebra. Let \mathbf{X} and \mathbf{Y} be vector fields. For $\mathbf{X} \circ \mathbf{Y}$ to be a vector field, it has to satisfy the derivation property. But

$$\begin{aligned} \mathbf{X} \circ \mathbf{Y}(fg) &= \mathbf{X}(\mathbf{Y}(fg)) = \mathbf{X}(\mathbf{Y}(f)g + f\mathbf{Y}(g)) \\ &= (\mathbf{X}(\mathbf{Y}(f)))g + \mathbf{Y}(f)\mathbf{X}(g) + \mathbf{X}(f)\mathbf{Y}(g) + f(\mathbf{X}(\mathbf{Y}(g))) \\ &\neq (\mathbf{X} \circ \mathbf{Y}(f))g + f(\mathbf{X} \circ \mathbf{Y}(g)). \end{aligned}$$

However, the reader may verify that $\mathbf{X} \circ \mathbf{Y} - \mathbf{Y} \circ \mathbf{X}$ does indeed satisfy the derivation property. Therefore, by defining the binary operation $\mathcal{X}(M) \times$

⁶Recall that a typical element of $\mathcal{T}_P(M)$ is a map $\mathbf{t}: F^\infty(P) \rightarrow \mathbb{R}$ for which composition is meaningless.

$\mathcal{X}(M) \rightarrow \mathcal{X}(M)$ as

$$[\mathbf{X}, \mathbf{Y}] \equiv \mathbf{X} \circ \mathbf{Y} - \mathbf{Y} \circ \mathbf{X},$$

$\mathcal{X}(M)$ becomes an algebra, called the **Lie algebra** of vector fields of M . The binary operation is called the **Lie bracket**. Although it was not mentioned at the time, we have encountered another example of a Lie algebra in Chap. 4, namely $\mathcal{L}(\mathcal{V})$ under the binary operation of the commutation relation. Lie brackets have the following two properties:

$$[\mathbf{X}, \mathbf{Y}] = -[\mathbf{Y}, \mathbf{X}],$$

$$[[\mathbf{X}, \mathbf{Y}], \mathbf{Z}] + [[\mathbf{Z}, \mathbf{X}], \mathbf{Y}] + [[\mathbf{Y}, \mathbf{Z}], \mathbf{X}] = 0.$$

These two relations are the defining properties of all Lie algebras. The last relation is called the **Jacobi identity**. $\mathcal{X}(M)$ with Lie brackets is an example of an infinite-dimensional Lie algebra; $\mathcal{L}(\mathcal{V})$ with commutators is an example of a finite-dimensional Lie algebra.

The set of vector fields forms a Lie algebra under Lie bracket multiplication.

Jacobi identity

We shall have occasion to use the following theorem in our treatment of Lie groups and algebras in Chap. 29:

Theorem 28.4.4 *Let M and N be manifolds and $F : M \rightarrow N$ a differentiable map. Assume that $\mathbf{X}_i \in \mathcal{X}(M)$ is F -related to $\mathbf{Y}_i \in \mathcal{X}(N)$ for $i = 1, 2$. Then $[\mathbf{X}_1, \mathbf{X}_2]$ is F -related to $[\mathbf{Y}_1, \mathbf{Y}_2]$, i.e.,*

$$F_*[\mathbf{X}_1, \mathbf{X}_2] = [F_*\mathbf{X}_1, F_*\mathbf{X}_2].$$

Proof Let f be an arbitrary function on N . Then

$$\begin{aligned} (F_*[\mathbf{X}_1, \mathbf{X}_2])f &\equiv [\mathbf{X}_1, \mathbf{X}_2](f \circ F) = \mathbf{X}_1(\mathbf{X}_2(f \circ F)) - \mathbf{X}_2(\mathbf{X}_1(f \circ F)) \\ &= \mathbf{X}_1([F_*\mathbf{X}_2(f)] \circ F) - \mathbf{X}_2([F_*\mathbf{X}_1(f)] \circ F) \\ &= F_*\mathbf{X}_1(F_*\mathbf{X}_2(f)) - F_*\mathbf{X}_2(F_*\mathbf{X}_1(f)) \\ &= [F_*\mathbf{X}_1, F_*\mathbf{X}_2]f, \end{aligned}$$

where we used Eq. (28.9) in the first, second, and third lines, and the result of Problem 28.8 in the second line. □

It is convenient to visualize vector fields as streamlines. In fact, most of the terminology used in three-dimensional vector analysis, such as flux, divergence, and curl, have their origins in the flow of fluids and the associated velocity vector fields. The streamlines are obtained—in nonturbulent flow—by starting at one point and drawing a curve whose tangent at all points is the velocity vector field. For a smooth flow this curve is unique. There is an exact analogy in manifold theory.

Definition 28.4.5 Let $\mathbf{X} \in \mathcal{X}(M)$ be defined on an open subset U of M . An **integral curve of \mathbf{X}** in U is a curve γ whose range lies in U and for every t in the domain of γ , the vector tangent to γ satisfies $\gamma_{*t} = \mathbf{X}(\gamma(t))$. If $\gamma(0) = P$, we say that γ **starts at P** .

integral curve of a vector field

Let us choose a coordinate system on M . Then $\mathbf{X} \equiv X^i \partial_i$, where X^i are \mathcal{C}^∞ functions on M , and, by (28.13), $\gamma_* = \dot{\gamma}^i \partial_i$. The equation for the integral curve of \mathbf{X} will therefore become

$$\dot{\gamma}^i \partial_i = X^i(\gamma(t)) \partial_i, \quad \text{or} \quad \frac{d\gamma^i}{dt} = X^i(\gamma^1(t), \dots, \gamma^m(t)), \quad i = 1, 2, \dots, m.$$

Since γ^i are simply coordinates of points on M , we rewrite the equation above as

$$\frac{dx^i}{dt} = X^i(x^1(t), \dots, x^m(t)), \quad i = 1, 2, \dots, m. \quad (28.19)$$

This is a system of first-order differential equations that has a unique (local) solution once the initial value $\gamma(0)$ of the curve, i.e., the coordinates of the starting point P , is given. The precise statement for existence and uniqueness of integral curves is contained in the following theorem.

Theorem 28.4.6 *Let \mathbf{X} be a \mathcal{C}^∞ vector field defined on an open subset U of M . Suppose $P \in U$, and $c \in \mathbb{R}$. Then there is a positive number ϵ and a unique integral curve γ of \mathbf{X} defined on $|t - c| \leq \epsilon$ such that $\gamma(c) = P$.*

Example 28.4.7 (Examples of integral curves)

- (a) Let $M = \mathbb{R}$ with coordinate function x . The vector field $\mathbf{X} = x \partial_x$ has an integral curve with initial point x_0 given by the DE $dx/dt = x(t)$, which has the solution $x(t) = e^t x_0$.
- (b) Let $M = \mathbb{R}^n$ with coordinate functions x^i . The vector field $\mathbf{X} = \sum a^i \partial_i$ has an integral curve, with initial point \mathbf{r}_0 , given by the system of DEs $dx^i/dt = a^i$, which has the solution $x^i(t) = a^i t + x_0^i$, or $\mathbf{r} = \mathbf{a}t + \mathbf{r}_0$. The curve is therefore a straight line parallel to \mathbf{a} going through \mathbf{r}_0 .
- (c) Let $M = \mathbb{R}^n$ with coordinate functions x^i . Consider the vector field

$$\mathbf{X} = \sum_{i,j=1}^n a_j^i x^j \partial_i.$$

The integral curve of this vector field, with initial point \mathbf{r}_0 , is given by the system of DEs $dx^i/dt = \sum_{j=1}^n a_j^i x^j$, which can be written in vector form as $d\mathbf{r}/dt = \mathbf{A}\mathbf{r}$ where \mathbf{A} is a constant matrix. By differentiating this equation several times, one can convince oneself that $d^k \mathbf{r}/dt^k = \mathbf{A}^k \mathbf{r}$. The Taylor expansion of $\mathbf{r}(t)$ then yields

$$\mathbf{r}(t) = \sum_{k=0}^{\infty} \frac{1}{k!} \left. \frac{d^k \mathbf{r}}{dt^k} \right|_{t=0} t^k = \sum_{k=0}^{\infty} \frac{t^k}{k!} \mathbf{A}^k \mathbf{r}_0 = e^{t\mathbf{A}} \mathbf{r}_0.$$

- (d) Let $M = \mathbb{R}^2$ with coordinate x, y . The reader may verify that the vector field $\mathbf{X} = -y \partial_x + x \partial_y$ has an integral curve through (x_0, y_0) given by

$$x = x_0 \cos t - y_0 \sin t,$$

$$y = x_0 \sin t + y_0 \cos t,$$

i.e., a circle centered at the origin passing through (x_0, y_0) .

Going back to the velocity vector field analogy, we can think of integral curves as the path of particles flowing with the fluid. If we think of the entire fluid as a manifold M , the flow of particles can be thought of as a transformation of M . To be precise, let M be an arbitrary manifold, and $\mathbf{X} \in \mathcal{X}(M)$. At each point P of M , there is a unique local integral curve γ_P of \mathbf{X} starting at P defined on an open subset U of M . The map $F_t : U \rightarrow M$ defined by $F_t(P) = \gamma_P(t)$ is a (local) transformation of M . The collection of such maps with different t 's is called the **flow** of the vector field \mathbf{X} . The uniqueness of the integral curve γ_P implies that F_t is a local diffeomorphism. In fact, the collection of maps $\{F_t\}_{t \in \mathbb{R}}$ forms a (local) **one-parameter group of transformations** in the sense that

$$F_t \circ F_s = F_{t+s}, \quad F_0 = \text{id}, \quad (F_t)^{-1} = F_{-t}. \quad (28.20)$$

One has to keep in mind that F_t at a point $P \in M$ is, in general, defined only *locally* in t , i.e., only for t in some open interval that depends on P . For some special, but important, cases this interval can be taken to be the entire \mathbb{R} for all P , in which case we speak of a **global one-parameter group of transformations**, and \mathbf{X} is called a **complete vector field** on M .

The symbol F_t used for the flow of the vector field \mathbf{X} does not contain its connection to \mathbf{X} . In order to make this connection, it is common to define

$$F_t \equiv \exp(t\mathbf{X}). \quad (28.21)$$

This definition, with no significance attached to “exp” at this point, converts Eq. (28.20) into

$$\begin{aligned} \exp(t\mathbf{X}) \circ \exp(s\mathbf{X}) &= \exp[(t + s)\mathbf{X}], \\ \exp(0\mathbf{X}) &= \text{id}, \\ [\exp(t\mathbf{X})]^{-1} &= \exp(-t\mathbf{X}), \end{aligned} \quad (28.22)$$

which notationally justifies the use of “exp”. We shall see in our discussion of Lie groups that this choice of notation is not accidental.

Using this notation, we can write

$$\mathbf{X}_P(f) \equiv \left. \frac{d}{dt} f \circ F_t(P) \right|_{t=0} = \left. \frac{d}{dt} f \circ \exp(t\mathbf{X}) \right|_{t=0}.$$

One usually leaves out the function f and writes

$$\mathbf{X}_P = \left. \frac{d}{dt} \exp(t\mathbf{X}) \right|_{t=0}, \quad (28.23)$$

where it is understood that the LHS acts on some f that must compose on the RHS to the left of the exponential. Similarly, we have

$$\begin{aligned} (F_*\mathbf{X})_{F(P)} &= \left. \frac{d}{dt} F(\exp t\mathbf{X}) \right|_{t=0}, \\ G_{*F(P)} \left(\underbrace{\left. \frac{d}{dt} F(\exp t\mathbf{X}) \right|_{t=0}}_{=F_*(\mathbf{X})} \right) &= \left. \frac{d}{dt} G \circ F(\exp t\mathbf{X}) \right|_{t=0}, \end{aligned} \quad (28.24)$$

where $F : M \rightarrow N$ and $G : N \rightarrow K$ are maps between manifolds.

Example 28.4.8 In this example, we derive a useful formula that gives the value of a function at a neighboring point of $P \in M$ located on the integral curve of $\mathbf{X} \in \mathcal{X}(M)$ going through P . We first note that since \mathbf{X}_P is tangent to γ_P at $P = \gamma(0)$, by Proposition 28.2.4 we have

$$\mathbf{X}_P(f) = \left. \frac{d}{dt} f(\gamma_P(t)) \right|_{t=0} = \left. \frac{d}{dt} f(F_t(P)) \right|_{t=0}.$$

Next we use the definition of derivative and the fact that $F_0(P) = P$ to write

$$\lim_{t \rightarrow 0} \frac{1}{t} [f(F_t(P)) - f(P)] = \mathbf{X}_P(f).$$

Now, if we assume that t is very small, we have

$$f(F_t(P)) = f(P) + t\mathbf{X}_P(f) + \dots, \quad (28.25)$$

which is a Taylor series with only the first two terms kept.

28.4.2 Tensor Fields

We have defined vector spaces $\mathcal{T}_P(M)$ at each point of M . We have also constructed coordinate bases, $\{\partial_i|_P\}_{i=1}^m$, for these vector spaces. At the end of Sect. 28.2, we showed that the differentials $\{dx^i|_P\}_{i=1}^m$ form a basis that is dual to $\{\partial_i|_P\}_{i=1}^m$. Let us concentrate on this dual space, which we will denote by $\mathcal{T}_P^*(M)$.

cotangent bundle of a manifold Taking the union of all $\mathcal{T}_P^*(M)$ at all points of M , we obtain the **cotangent bundle** of M :

$$T^*(M) = \bigcup_{P \in M} \mathcal{T}_P^*(M). \quad (28.26)$$

This is the dual space of $T(M)$ at each point of M . We can now define the analogue of the vector field for the cotangent bundle.

differential one-form **Definition 28.4.9** A **differential one-form** θ on a subset U of a manifold M is a mapping $\theta : U \rightarrow T^*(M)$ such that $\theta(P) \equiv \theta_P \in \mathcal{T}_P^*(M)$. The collection of all one-forms on M is denoted by $\mathcal{X}^*(M)$.

If θ is a one-form and \mathbf{X} is a vector field on M , then $\theta(\mathbf{X})$ is a real-valued function on M defined naturally by $[\theta(\mathbf{X})](P) \equiv (\theta_P)(\mathbf{X}_P)$. The first factor on the RHS is a linear functional at P , and the second factor is a vector at P . So, the pairing of the two factors produces a real number. A prototypical one-form is the coordinate differential, dx^i .

Associated with a differentiable map $\psi : M \rightarrow N$, we defined a differential ψ_* that mapped a tangent space of M to a tangent space of N . The dual of ψ_* (Definition 2.5.4) is denoted by ψ^* and is called the **pullback** of ψ . It takes a one-form on N to a one-form on M . In complete analogy to the case of vector fields, θ can be written in terms of the basis $\{dx^i\}$: $\theta = \theta_i dx^i$. Here θ_i , the components of θ , are real-valued functions on M .

pullback of a differentiable map

With the vector spaces $\mathcal{T}_P(M)$ and $\mathcal{T}_P^*(M)$ at our disposal, we can construct various kinds of tensors at each point P . The union of all these tensors is a manifold, and a tensor field can be defined as usual. Thus, we have the following definition.

Definition 28.4.10 Let $\mathcal{T}_P(M)$ and $\mathcal{T}_P^*(M)$ be the tangent and cotangent spaces at $P \in M$. Then the set of tensors of type (r, s) on $\mathcal{T}_P(M)$ is denoted by $\mathcal{T}_{s,P}^r(M)$. The **bundle of tensors** of type (r, s) over M , denoted by $T_s^r(M)$, is

bundle of tensors and tensor fields

$$T_s^r(M) = \bigcup_{P \in M} \mathcal{T}_{s,P}^r(M).$$

A **tensor field** \mathbf{T} of type (r, s) over a subset U of M is a mapping $\mathbf{T} : U \rightarrow T_s^r(M)$ such that $\mathbf{T}(P) \equiv \mathbf{T}_P \equiv \mathbf{T}|_P \in \mathcal{T}_{s,P}^r(M)$.

In particular, $T_0^0(M)$ is the set of real-valued functions on M , $T_0^1(M) = T(M)$, and $T_1^0(M) = T^*(M)$. Furthermore, since \mathbf{T} is a multilinear map, the parentheses are normally reserved for vectors and their duals, and as indicated in Definition 28.4.10, the value of \mathbf{T} at $P \in M$ is written as \mathbf{T}_P or $\mathbf{T}|_P$. The reader may check that the map

$$\mathbf{T} : \underbrace{\mathcal{X}^*(M) \times \cdots \times \mathcal{X}^*(M)}_{r \text{ times}} \times \underbrace{\mathcal{X}(M) \times \cdots \times \mathcal{X}(M)}_{s \text{ times}} \rightarrow T_0^0(M)$$

defined by

$$[\mathbf{T}(\omega^1, \dots, \omega^r, \mathbf{v}_1, \dots, \mathbf{v}_s)](P) = \mathbf{T}_P(\omega^1|_P, \dots, \omega^r|_P, \mathbf{v}_1|_P, \dots, \mathbf{v}_s|_P)$$

has the property that

A crucial property of tensors

$$\begin{aligned} \mathbf{T}(\dots, f\omega^j + g\theta^j, \dots) &= f\mathbf{T}(\dots, \omega^j, \dots) + g\mathbf{T}(\dots, \theta^j, \dots), \\ \mathbf{T}(\dots, f\mathbf{v}_k + g\mathbf{u}_k, \dots) &= f\mathbf{T}(\dots, \mathbf{v}_k, \dots) + g\mathbf{T}(\dots, \mathbf{u}_k, \dots) \end{aligned} \tag{28.27}$$

for any two functions f and g on M . Thus,⁷

⁷In mathematical jargon, $\mathcal{X}(M)$ and $\mathcal{X}^*(M)$ are called **modules** over the (ring of) real-valued functions on M . Rings are a generalization of the real numbers (field of real numbers) whose elements have all the properties of a field except that they may have no inverse. A module over a field is a vector space.

Box 28.4.11 *A tensor is linear in vector fields and 1-forms, even when the coefficients of linear expansion are functions.*

The components of \mathbf{T} with respect to coordinates x^i are the m^{r+s} real-valued functions

$$T_{j_1 j_2 \dots j_s}^{i_1 i_2 \dots i_r} = \mathbf{T}(dx^{i_1}, dx^{i_2}, \dots, dx^{i_r}, \partial_{j_1}, \partial_{j_2}, \dots, \partial_{j_s}).$$

If tensor fields are to be of any use, we must be able to differentiate them. We shall consider three types of derivatives with different applications. We study one of them here, another in the next section, and the third in Chap. 36.

Derivatives can be defined only for objects that can be added. For functions of a single (real or complex) variable, this is done almost subconsciously: We take the difference between the values of the function at two nearby points and divide by the length of the interval between the two points. We extended this definition to operators in Chap. 4 with practically no change. For functions of more than one variable, one chooses a direction (a vector) and considers change in the function along that direction. This leads to the concept of **directional derivative**, or partial derivative when the vector happens to be along one of the axes.

In all the above cases, the objects being differentiated reside in the *same* space: $f(t)$ and $f(t + \Delta t)$ are both real (complex) numbers; $\mathbf{H}(t)$ and $\mathbf{H}(t + \Delta t)$ both belong to $\mathcal{L}(\mathcal{V})$. When we try to define derivatives of tensor fields, however, we run immediately into trouble: \mathbf{T}_P and $\mathbf{T}_{P'}$ cannot be compared because they belong to two different spaces, one to $\mathcal{J}_{s,P}^r(M)$ and the other to $\mathcal{J}_{s,P'}^r(M)$. To make comparisons, we need first to establish a “connection” between the two spaces. This connection has to be a vector space isomorphism so that there is one and only one vector in the second space that is to be compared with a given vector in the first space. The problem is that there are infinitely many isomorphisms between any given two vector spaces. No “natural” isomorphism exists between $\mathcal{J}_{s,P}^r(M)$ and $\mathcal{J}_{s,P'}^r(M)$; thus the diversity of tensor “derivatives!” We narrow down this diversity by choosing a specific vector at $\mathcal{J}_{s,P}^r(M)$ and seeking a natural way of defining the derivative along that vector by associating a “natural” isomorphism corresponding to the vector. There are a few methods of doing this. We describe one of them here.

First, let us see what happens to tensor fields under a diffeomorphism of M onto itself. Let $F : M \rightarrow M$ be such a diffeomorphism. The differential F_{*P} of this diffeomorphism is an isomorphism of $\mathcal{T}_P(M)$ and $\mathcal{T}_{F(P)}(M)$. This isomorphism induces an isomorphism of the vector spaces $\mathcal{J}_{s,P}^r(M)$ and $\mathcal{J}_{s,F(P)}^r(M)$ —also denoted by F_{*P} —by Eq. (26.10). Let us denote by F_* a map of $T(M)$ onto $T(M)$ whose restriction to $\mathcal{T}_P(M)$ is F_{*P} . If \mathbf{T} is a tensor field on M , then $F_*(\mathbf{T})$ is also a tensor field, whose value at $F(Q)$ is obtained by letting F_{*Q} act on $\mathbf{T}(Q)$:

$$[F_*(\mathbf{T})](F(Q)) = F_{*Q}(\mathbf{T}(Q)),$$

or, letting $P = F(Q)$ or $Q = F^{-1}(P)$,

$$[F_*\mathbf{T}](P) = F_{*F^{-1}(P)}(\mathbf{T}(F^{-1}(P))). \quad (28.28)$$

Now, let \mathbf{X} be a vector field and $P \in M$. The flow of \mathbf{X} at P defines a local diffeomorphism $F_t : U \rightarrow F_t(U)$ with $P \in U$. The differential F_{t*} of this diffeomorphism is an isomorphism of $\mathcal{T}_P(M)$ and $\mathcal{T}_{F_t(P)}(M)$. As discussed above, this isomorphism induces an isomorphism of the vector space $\mathcal{T}'_{s,P}(M)$ onto itself. The derivative we are after is defined by comparing a tensor field evaluated at P with the image of the same tensor field under the isomorphism F_{t*}^{-1} . The following definition makes this procedure more precise.

Definition 28.4.12 Let $P \in M$, $\mathbf{X} \in \mathcal{X}(M)$, and F_t the flow of \mathbf{X} defined in a neighborhood of P . The **Lie derivative** of a tensor field \mathbf{T} at P with respect to \mathbf{X} is denoted by $(L_{\mathbf{X}}\mathbf{T})_P$ and defined by

Lie derivative of tensor fields with respect to a vector field

$$(L_{\mathbf{X}}\mathbf{T})_P = \lim_{t \rightarrow 0} \frac{1}{t} [F_{t*}^{-1}\mathbf{T}_{F_t(P)} - \mathbf{T}_P] \equiv \left. \frac{d}{dt} F_{t*}^{-1}\mathbf{T}_{F_t(P)} \right|_{t=0}. \quad (28.29)$$

Let us calculate the derivative in Eq. (28.29) at an arbitrary value of t . For this purpose, let $Q \equiv F_t(P)$. Then

$$\begin{aligned} \frac{d}{dt} F_{t*}^{-1}\mathbf{T}_{F_t(P)} &\equiv \lim_{\Delta t \rightarrow 0} \frac{1}{\Delta t} [F_{(t+\Delta t)*}^{-1}\mathbf{T}_{F_{t+\Delta t}(P)} - F_{t*}^{-1}\mathbf{T}_{F_t(P)}] \\ &= F_{t*}^{-1} \lim_{\Delta t \rightarrow 0} \frac{1}{\Delta t} [F_{\Delta t*}^{-1}\mathbf{T}_{F_{t+\Delta t}(P)} - \mathbf{T}_{F_t(P)}] \\ &= F_{t*}^{-1} \lim_{\Delta t \rightarrow 0} \frac{1}{\Delta t} [F_{\Delta t*}^{-1}\mathbf{T}_{F_{\Delta t}(Q)} - \mathbf{T}_Q] \equiv F_{t*}^{-1}(L_{\mathbf{X}}\mathbf{T})_Q. \end{aligned}$$

Since Q is arbitrary, we can remove it from the equation and write, as the generalization of Eq. (28.29),

$$L_{\mathbf{X}}\mathbf{T} = F_{t*} \frac{d}{dt} F_{t*}^{-1}\mathbf{T}. \quad (28.30)$$

An important special case of the definition above is the Lie derivative of a vector field with respect to another. Let $\mathbf{X}, \mathbf{Y} \in \mathcal{X}(M)$. To evaluate the RHS of (28.29), we apply the first term in the brackets to an arbitrary function f ,

$$\begin{aligned} [F_{t*}^{-1}\mathbf{Y}_{F_t(P)}](f) &= \mathbf{Y}_{F_t(P)}(f \circ F_t^{-1}) = \mathbf{Y}(f \circ F_t^{-1})|_{F_t(P)} \\ &= \mathbf{Y}(f \circ F_{-t})|_{F_t(P)} = \mathbf{Y}(f - t\mathbf{X}(f))|_{F_t(P)} \\ &= (\mathbf{Y}f)_{F_t(P)} - t\mathbf{Y}(\mathbf{X}(f))|_{F_t(P)} \\ &= (\mathbf{Y}f)_P + t[\mathbf{X}(\mathbf{Y}f)]_P - t\{[\mathbf{Y}(\mathbf{X}f)]_P \\ &\quad + t[\mathbf{X}(\mathbf{Y}(\mathbf{X}f))]_P\} \\ &= \mathbf{Y}_P(f) + t\mathbf{X}_P \circ \mathbf{Y}_P(f) - t\mathbf{Y}_P \circ \mathbf{X}_P(f) \\ &= \mathbf{Y}_P(f) + t[\mathbf{X}_P, \mathbf{Y}_P](f) = \mathbf{Y}_P(f) + t[\mathbf{X}, \mathbf{Y}]_P(f). \end{aligned}$$

The first equality on the first line follows from (28.9), the second equality from the meaning of $\mathbf{Y}_{F_t(P)}$; the second equality on the second line and the fourth line follow from (28.25). Finally, the fifth line follows if we ignore the t^2 term. Therefore,

$$\begin{aligned}(L_{\mathbf{X}}\mathbf{Y})_P(f) &= \lim_{t \rightarrow 0} \frac{1}{t} [F_{t*}^{-1} \mathbf{Y}_{F_t(P)} - \mathbf{Y}_P](f) \\ &= \lim_{t \rightarrow 0} \frac{1}{t} \{t[\mathbf{X}, \mathbf{Y}]_P\}(f) = [\mathbf{X}, \mathbf{Y}]_P(f).\end{aligned}$$

Lie derivative is commutator Since this is true for all P and f , we get

$$L_{\mathbf{X}}\mathbf{Y} = [\mathbf{X}, \mathbf{Y}]. \quad (28.31)$$

This and other properties of the Lie derivative are summarized in the following proposition.

Proposition 28.4.13 *Let $\mathbf{T} \in T_s^r(M)$ and \mathbf{T}' be arbitrary tensor fields and \mathbf{X} a given vector field. Then*

Properties of Lie derivative

1. $L_{\mathbf{X}}$ satisfies a derivation property in the algebra of tensor fields, i.e.,

$$L_{\mathbf{X}}(\mathbf{T} \otimes \mathbf{T}') = (L_{\mathbf{X}}\mathbf{T}) \otimes \mathbf{T}' + \mathbf{T} \otimes (L_{\mathbf{X}}\mathbf{T}').$$

2. $L_{\mathbf{X}}$ is type-preserving, i.e., $L_{\mathbf{X}}\mathbf{T}$ is a tensor field of type (r, s) .
3. $L_{\mathbf{X}}$ commutes with the operation of contraction of tensor fields; in particular, in combination with property 1, we have

$$L_{\mathbf{X}}\langle \boldsymbol{\theta}, \mathbf{Y} \rangle = \langle L_{\mathbf{X}}\boldsymbol{\theta}, \mathbf{Y} \rangle + \langle \boldsymbol{\theta}, L_{\mathbf{X}}\mathbf{Y} \rangle.$$

4. $L_{\mathbf{X}}f = \mathbf{X}f$ for every function f .
5. $L_{\mathbf{X}}\mathbf{Y} = [\mathbf{X}, \mathbf{Y}]$ for every vector field \mathbf{Y} .

Proof Except for the last property, which we demonstrated above, the rest follow directly from definitions and simple manipulations. The details are left as exercises. \square

Although the Lie derivative of a vector field is nicely given in terms of commutators, no such simple relation exists for the Lie derivative of a 1-form. However, if we work in a given coordinate frame, then a useful expression for the Lie derivative of a 1-form can be obtained. Applying $L_{\mathbf{X}}$ to $\langle \boldsymbol{\theta}, \mathbf{X} \rangle$, we obtain

$$\underbrace{L_{\mathbf{X}}\langle \boldsymbol{\theta}, \mathbf{Y} \rangle}_{= \mathbf{X}\langle \boldsymbol{\theta}, \mathbf{Y} \rangle} = \langle L_{\mathbf{X}}\boldsymbol{\theta}, \mathbf{Y} \rangle + \langle \boldsymbol{\theta}, L_{\mathbf{X}}\mathbf{Y} \rangle = \langle L_{\mathbf{X}}\boldsymbol{\theta}, \mathbf{Y} \rangle + \langle \boldsymbol{\theta}, [\mathbf{X}, \mathbf{Y}] \rangle. \quad (28.32)$$

In particular, if $\mathbf{Y} = \partial_i$ and we write $\mathbf{X} = X^j \partial_j$, $\boldsymbol{\theta} = \theta_j dx^j$, then the LHS becomes $\mathbf{X}\langle \boldsymbol{\theta}, \partial_i \rangle = X^j \partial_j \theta_i$, and the RHS can be written as

$$(L_{\mathbf{X}}\boldsymbol{\theta})_i + \langle \boldsymbol{\theta}, \underbrace{[X^j \partial_j, \partial_i]}_{-(\partial_i X^j) \partial_j} \rangle.$$

It follows that

$$L_{\mathbf{X}}\boldsymbol{\theta} \equiv (L_{\mathbf{X}}\boldsymbol{\theta})_i dx^i = (X^j \partial_j \theta_i + \theta_j \partial_i X^j) dx^i. \quad (28.33)$$

We give two other useful properties of the Lie derivative applicable to all tensors. From the Jacobi identity one can readily deduce that

$$L_{[\mathbf{X}, \mathbf{Y}]} \mathbf{Z} = L_{\mathbf{X}} L_{\mathbf{Y}} \mathbf{Z} - L_{\mathbf{Y}} L_{\mathbf{X}} \mathbf{Z}.$$

Similarly, Eq. (28.32) yields

$$L_{[\mathbf{X}, \mathbf{Y}]} \boldsymbol{\theta} = L_{\mathbf{X}} L_{\mathbf{Y}} \boldsymbol{\theta} - L_{\mathbf{Y}} L_{\mathbf{X}} \boldsymbol{\theta}.$$

Putting these two equations together, recalling that a general tensor is a linear combination of tensor products of vectors and 1-forms, and that the Lie derivative obeys the product rule of differentiation, we obtain

$$L_{[\mathbf{X}, \mathbf{Y}]} \mathbf{T} = L_{\mathbf{X}} L_{\mathbf{Y}} \mathbf{T} - L_{\mathbf{Y}} L_{\mathbf{X}} \mathbf{T} \quad (28.34)$$

for any tensor field \mathbf{T} . Furthermore, Eq. (28.33) and the linearity of the Lie bracket imply that $L_{\alpha \mathbf{X} + \beta \mathbf{Y}} = \alpha L_{\mathbf{X}} + \beta L_{\mathbf{Y}}$ when acting on vectors and 1-forms. It follows by the same argument as above that

$$L_{\alpha \mathbf{X} + \beta \mathbf{Y}} \mathbf{T} = \alpha L_{\mathbf{X}} \mathbf{T} + \beta L_{\mathbf{Y}} \mathbf{T} \quad \forall \mathbf{T} \in \mathcal{T}_s^r(M). \quad (28.35)$$

Equation (28.32) gives a rule for calculating the Lie derivative of a 1-form, i.e., it tells us how to evaluate $L_{\mathbf{X}}\boldsymbol{\theta}$ on a vector \mathbf{Y} . We can generalize this for a p -form $\boldsymbol{\omega}$. Write the evaluation of $\boldsymbol{\omega}$ on p vectors as p contractions as in Eq. (26.8):

$$\boldsymbol{\omega}(\mathbf{X}_1, \mathbf{X}_2, \dots, \mathbf{X}_p) = \mathbf{C}_p^p \cdots \mathbf{C}_2^2 \mathbf{C}_1^1 (\boldsymbol{\omega} \otimes \mathbf{X}_1 \otimes \mathbf{X}_2 \otimes \cdots \otimes \mathbf{X}_p).$$

Now apply the Lie derivative on both sides and use its derivation property and the fact that it commutes with contractions to get

$$L_{\mathbf{X}}(\boldsymbol{\omega}(\mathbf{X}_1, \mathbf{X}_2, \dots, \mathbf{X}_p)) = \mathbf{C}_p^p \cdots \mathbf{C}_2^2 \mathbf{C}_1^1 L_{\mathbf{X}}(\boldsymbol{\omega} \otimes \mathbf{X}_1 \otimes \mathbf{X}_2 \otimes \cdots \otimes \mathbf{X}_p).$$

The left-hand side is just $\mathbf{X}(\boldsymbol{\omega}(\mathbf{X}_1, \mathbf{X}_2, \dots, \mathbf{X}_p))$. For the right-hand side, we use

$$\begin{aligned} & L_{\mathbf{X}}(\boldsymbol{\omega} \otimes \mathbf{X}_1 \otimes \cdots \otimes \mathbf{X}_p) \\ &= (L_{\mathbf{X}}\boldsymbol{\omega}) \otimes \mathbf{X}_1 \otimes \cdots \otimes \mathbf{X}_p + \sum_{i=1}^p \boldsymbol{\omega} \otimes \mathbf{X}_1 \otimes \cdots \otimes L_{\mathbf{X}}\mathbf{X}_i \otimes \cdots \otimes \mathbf{X}_p. \end{aligned}$$

Applying the contractions, using $L_{\mathbf{X}}\mathbf{X}_i = [\mathbf{X}, \mathbf{X}_i]$, and putting everything together, we obtain

$$\begin{aligned} & \mathbf{X}(\boldsymbol{\omega}(\mathbf{X}_1, \mathbf{X}_2, \dots, \mathbf{X}_p)) \\ &= (L_{\mathbf{X}}\boldsymbol{\omega})(\mathbf{X}_1, \dots, \mathbf{X}_p) + \sum_{i=1}^p \boldsymbol{\omega}(\mathbf{X}_1, \dots, [\mathbf{X}, \mathbf{X}_i], \dots, \mathbf{X}_p) \end{aligned}$$

which finally gives the rule by which $L_{\mathbf{X}}\omega$ acts on p vectors:

$$\begin{aligned} & (L_{\mathbf{X}}\omega)(\mathbf{X}_1, \dots, \mathbf{X}_p) \\ &= \mathbf{X}(\omega(\mathbf{X}_1, \mathbf{X}_2, \dots, \mathbf{X}_p)) - \sum_{i=1}^p \omega(\mathbf{X}_1, \dots, [\mathbf{X}, \mathbf{X}_i], \dots, \mathbf{X}_p). \end{aligned} \quad (28.36)$$

28.5 Exterior Calculus

Skew-symmetric tensors are of special importance to applications. We studied these tensors in their algebraic format in Chap. 26. Let us now investigate them as they reside on manifolds.

differential forms, or
simply forms, defined

Definition 28.5.1 Let M be a manifold and Q a point of M . Let $\Lambda_Q^p(M)$ denote the space of all antisymmetric tensors of rank p over the tangent space at Q . Let $\Lambda^p(M)$ be the union of all $\Lambda_Q^p(M)$ for all $Q \in M$. A **differential p -form** ω is a mapping $\omega : U \rightarrow \Lambda^p(M)$ such that $\omega(Q) \in \Lambda_Q^p(M)$ where U is, as usual, a subset of M . To emphasize their domain of definition, we sometimes use the notation $\Lambda^p(U)$.

Since $\{dx^i\}_{i=1}^m$ is a basis for $T_Q^*(M)$ at every $Q \in M$, $\{dx^{i_1} \wedge \dots \wedge dx^{i_p}\}$ is a basis for the p -forms. All the algebraic properties established in Chap. 26 apply to these p -forms at every point $Q \in M$.

The concept of a pullback has been mentioned a number of times in connection with linear maps. The most frequent use of pullbacks takes place in conjunction with the p -forms.

defining pullback for
differential forms

Definition 28.5.2 Let M and N be manifolds and $\psi : M \rightarrow N$ a differentiable map. The **pullback map** on p -forms is the map $\psi^* : \Lambda^p(N) \rightarrow \Lambda^p(M)$ defined by

$$\psi^* \rho(\mathbf{X}_1, \dots, \mathbf{X}_p) = \rho(\psi_* \mathbf{X}_1, \dots, \psi_* \mathbf{X}_p) \quad \text{for } \rho \in \Lambda^p(N).$$

For $p = 0$, i.e., for functions on M , $\psi^* \omega \equiv \omega \circ \psi$.

It can be shown that

$$\psi^*(\omega \wedge \eta) = \psi^* \omega \wedge \psi^* \eta, \quad (\psi \circ \phi)^* = \phi^* \circ \psi^*. \quad (28.37)$$

Since ω varies from point to point, we can define its derivatives. Recall that $T_0^0(M)$ is the collection of real-valued functions on M . Since the dual of \mathbb{R} is \mathbb{R} , we conclude that $\Lambda^0(M)$, the collection of zero-forms, is the union of all real-valued functions on M . Also recall that if f is a zero-form, then df , the differential of f , is a one-form. Thus, the differential operator d creates a one-form from a zero-form. The fact that this can be generalized to p -forms is the subject of the next theorem (for a proof, see [Abra 88, pp. 111–112]).

Theorem 28.5.3 For each point Q of M , there exists a neighborhood U and a unique operator $d : \Lambda^p(U) \rightarrow \Lambda^{p+1}(U)$, called the **exterior derivative operator**, such that for any $\omega \in \Lambda^p(U)$ and $\eta \in \Lambda^q(U)$,

1. $d(\omega + \eta) = d\omega + d\eta$ if $q = p$; otherwise the sum is not defined.
2. $d(\omega \wedge \eta) = (d\omega) \wedge \eta + (-1)^p \omega \wedge (d\eta)$; this is called the **antiderivation property** of d with respect to the wedge product. exterior derivative and its antiderivation property
3. $d(d\omega) = 0$ for any differential form ω ; stated differently, $d \circ d = 0$.
4. $df = (\partial_i f) dx^i$ for any real-valued function f .
5. d is **natural with respect to pullback**; that is, $d_M \circ \psi^* = \psi^* \circ d_N$ for any differentiable map $\psi : M \rightarrow N$. Here d_M (d_N) is the exterior derivative operating on differential forms of M (N).

Example 28.5.4 Let $M = \mathbb{R}^3$ and $\omega = a_i dx^i$ a 1-form on M . The exterior derivative of ω is

$$d\omega = (da_i) \wedge dx^i = (\partial_j a_i dx^j) \wedge dx^i = \sum_{j < i} (\partial_j a_i - \partial_i a_j) dx^j \wedge dx^i.$$

We see that the components of $d\omega$ are the components of $\nabla \times \mathbf{A}$ where $\mathbf{A} = (a_1, a_2, a_3)$. It follows that the curl of a vector in \mathbb{R}^3 is the exterior derivative of the 1-form constructed out of the components of the vector.

Example 28.5.5 In relativistic electromagnetic theory the electric and magnetic fields are combined to form the electromagnetic field tensor. This is a skew-symmetric tensor field of rank 2, which can be written as⁸ The homogeneous Maxwell's equations are written in terms of differential forms.

$$\begin{aligned} \mathbf{F} = & -E_x dt \wedge dx - E_y dt \wedge dy - E_z dt \wedge dz \\ & + B_z dx \wedge dy - B_y dx \wedge dz + B_x dy \wedge dz, \end{aligned} \tag{28.38}$$

where t is the time coordinate and the units are such that c , the velocity of light, is equal to 1.

Let us take the exterior derivative of \mathbf{F} . In the process, we use $df = (\partial_i f) dx^i$, $d(dx^i \wedge dx^j) = 0$, and in dE_i or dB_j we include only the terms that give a nonzero contribution:

$$\begin{aligned} d\mathbf{F} = & -\left(\frac{\partial E_x}{\partial y} dy + \frac{\partial E_x}{\partial z} dz\right) \wedge dt \wedge dx - \left(\frac{\partial E_y}{\partial x} dx + \frac{\partial E_y}{\partial z} dz\right) \wedge dt \wedge dy \\ & - \left(\frac{\partial E_z}{\partial x} dx + \frac{\partial E_z}{\partial y} dy\right) \wedge dt \wedge dz + \left(\frac{\partial B_z}{\partial t} dt + \frac{\partial B_z}{\partial z} dz\right) \wedge dx \wedge dy \\ & - \left(\frac{\partial B_y}{\partial t} dt + \frac{\partial B_y}{\partial y} dy\right) \wedge dx \wedge dz + \left(\frac{\partial B_x}{\partial t} dt + \frac{\partial B_x}{\partial x} dx\right) \wedge dy \wedge dz. \end{aligned}$$

⁸Note how in the wedge product, the first factor has a lower index (is an “earlier” coordinate) than the second factor. If this restriction is to be removed, we need to introduce a factor of $\frac{1}{2}$ for each component (see Example 28.5.12).

Collecting all similar terms and taking into account changes of sign due to the antisymmetry of the exterior products gives

$$\begin{aligned}
 d\mathbf{F} &= \left(\frac{\partial E_y}{\partial x} - \frac{\partial E_x}{\partial y} + \frac{\partial B_z}{\partial t} \right) dt \wedge dx \wedge dy \\
 &\quad + \left(\frac{\partial E_z}{\partial x} - \frac{\partial E_x}{\partial z} - \frac{\partial B_y}{\partial t} \right) dt \wedge dx \wedge dz \\
 &\quad + \left(\frac{\partial E_z}{\partial y} - \frac{\partial E_y}{\partial z} + \frac{\partial B_x}{\partial t} \right) dt \wedge dy \wedge dz \\
 &\quad + \left(\frac{\partial B_x}{\partial x} + \frac{\partial B_y}{\partial y} + \frac{\partial B_z}{\partial z} \right) dx \wedge dy \wedge dz \\
 &= \left[\left(\nabla \times \mathbf{E} + \frac{\partial \mathbf{B}}{\partial t} \right)_z \right] dt \wedge dx \wedge dy \\
 &\quad + \left[\left(\nabla \times \mathbf{E} + \frac{\partial \mathbf{B}}{\partial t} \right)_y \right] dt \wedge dz \wedge dx \\
 &\quad + \left[\left(\nabla \times \mathbf{E} + \frac{\partial \mathbf{B}}{\partial t} \right)_x \right] dt \wedge dy \wedge dz + (\nabla \cdot \mathbf{B}) dx \wedge dy \wedge dz.
 \end{aligned}$$

Each component of $d\mathbf{F}$ vanishes because of Maxwell's equations.

The example above shows that

Box 28.5.6 *The two homogeneous Maxwell's equations can be written as $d\mathbf{F} = 0$, where \mathbf{F} is defined by Eq. (28.38).*

The exterior derivative is a very useful concept in the theory of differential forms, as illustrated in the preceding example. However, that is not the only differentiation available to the differential forms. We have already defined the Lie derivative for arbitrary tensors. Since differential forms are (antisymmetrized) linear combinations of covariant tensors, Lie differentiation is defined for them as well. In fact, since differential forms have no contravariant parts, one uses the pullback map F_t^* in the definition of the Lie derivative instead of F_{t*}^{-1} :

$$L_{\mathbf{X}}\omega = (F_t^*)^{-1} \frac{d}{dt} F_t^* \omega. \quad (28.39)$$

The two derivatives defined so far have the following convenient property, whose proof is left as an exercise for the reader:

Theorem 28.5.7 *The exterior derivative d is natural with respect to $L_{\mathbf{X}}$ (or commutes with $L_{\mathbf{X}}$) for $\mathbf{X} \in \mathcal{X}(M)$; that is, $d \circ L_{\mathbf{X}} = L_{\mathbf{X}} \circ d$.*

In the last chapter, we defined the interior product i_θ for p -vectors, where θ is a 1-form. With our shift of emphasis from p -vectors to p -forms in this chapter, we need to shift the role of vectors and forms.

Definition 28.5.8 Let \mathbf{X} be a vector field and ω a p -form on a manifold M . Then the interior product $i_{\mathbf{X}} : \Lambda^p(M) \rightarrow \Lambda^{p-1}(M)$ is defined as follows:

$$i_{\mathbf{X}}\omega(\mathbf{X}_1, \dots, \mathbf{X}_{p-1}) = \omega(\mathbf{X}, \mathbf{X}_1, \dots, \mathbf{X}_{p-1}).$$

interior product of a vector field and a differential form

If $\omega \in \Lambda^0(M)$, i.e., if ω is just a function, we set $i_{\mathbf{X}}\omega = 0$. Another notation commonly used for $i_{\mathbf{X}}\omega$ is $\mathbf{X}\lrcorner\omega$.

The interior product $i_{\mathbf{X}}$ has the antiderivation property of Theorem 27.0.2:

Theorem 28.5.9 Let ω be a p -form and η a q -form on a manifold M . Then

$$i_{\mathbf{X}}(\omega \wedge \eta) = (i_{\mathbf{X}}\omega) \wedge \eta + (-1)^p \omega \wedge (i_{\mathbf{X}}\eta).$$

We have introduced three types of derivation on the algebra of differential forms: the exterior derivative, the Lie derivative, and the interior product. The following theorem connects all three derivations in a most useful way (see A[Abra 88, pp. 115–116]):

Theorem 28.5.10 Let $\omega \in \Lambda^p(M)$, $f \in \Lambda^0(M)$, and $\mathbf{X} \in \mathfrak{X}(M)$. Let $i_{\mathbf{X}} : \Lambda^p(M) \rightarrow \Lambda^{p-1}(M)$, $d : \Lambda^p(M) \rightarrow \Lambda^{p+1}(M)$, and $L_{\mathbf{X}} : \Lambda^p(M) \rightarrow \Lambda^p(M)$ be the interior product, the exterior derivative, and the Lie derivative, respectively. Then

Relation between d , $L_{\mathbf{X}}$, and $i_{\mathbf{X}}$

1. $i_{\mathbf{X}}df = L_{\mathbf{X}}f.$
2. $L_{\mathbf{X}} = i_{\mathbf{X}} \circ d + d \circ i_{\mathbf{X}}.$
3. $L_{f\mathbf{X}}\omega = fL_{\mathbf{X}}\omega + df \wedge i_{\mathbf{X}}\omega.$

If $\mathbf{X} = X^j \partial_j$ and $\omega = \omega_{i_1 i_2 \dots i_p} dx^{i_1} \wedge dx^{i_2} \wedge \dots \wedge dx^{i_p}$, then the reader may verify that $i_{\mathbf{X}}\omega = X^i \omega_{i i_1 \dots i_p} dx^{i_1} \wedge \dots \wedge dx^{i_p}$. In particular, we have the useful formula

$$\begin{aligned} i_{\mathbf{X}}(dx^{i_1} \wedge dx^{i_2} \wedge \dots \wedge dx^{i_p}) &= X^j \delta_{j i_1 \dots i_p} dx^{i_1} \wedge dx^{i_2} \wedge \dots \wedge dx^{i_p} \\ &= X^j \left(\sum_{\pi} \epsilon_{\pi} \delta_{\pi(j)}^{i_1} \delta_{\pi(j_1)}^{i_2} \dots \delta_{\pi(j_p)}^{i_p} \right) dx^{j_1} \wedge dx^{j_2} \wedge \dots \wedge dx^{j_p}. \end{aligned} \quad (28.40)$$

Theorem 28.5.11 For a p -form ω , we have

$$\begin{aligned} d\omega(\mathbf{X}_1, \dots, \mathbf{X}_{p+1}) &= \sum_{i=1}^{p+1} (-1)^{i+1} \mathbf{X}_i(\omega(\mathbf{X}_1, \dots, \hat{\mathbf{X}}_i, \dots, \mathbf{X}_{p+1})) \\ &\quad + \sum_{1 \leq i < j \leq p+1} (-1)^{i+j} \omega([\mathbf{X}_i, \mathbf{X}_j], \mathbf{X}_1, \dots, \hat{\mathbf{X}}_i, \dots, \hat{\mathbf{X}}_j, \dots, \mathbf{X}_{p+1}) \end{aligned}$$

where the circumflex on a symbol means that symbol is to be omitted.

Proof We use mathematical induction on p . From item 2 of Theorem 28.5.10, we have

$$L_{\mathbf{X}}\boldsymbol{\omega} = i_{\mathbf{X}}(d\boldsymbol{\omega}) + d(i_{\mathbf{X}}\boldsymbol{\omega})$$

or

$$(L_{\mathbf{X}}\boldsymbol{\omega})(\mathbf{X}_1, \dots, \mathbf{X}_p) = \underbrace{(i_{\mathbf{X}}(d\boldsymbol{\omega}))(\mathbf{X}_1, \dots, \mathbf{X}_p)}_{=d\boldsymbol{\omega}(\mathbf{X}, \mathbf{X}_1, \dots, \mathbf{X}_p)} + d(i_{\mathbf{X}}\boldsymbol{\omega})(\mathbf{X}_1, \dots, \mathbf{X}_p)$$

or

$$d\boldsymbol{\omega}(\mathbf{X}, \mathbf{X}_1, \dots, \mathbf{X}_p) = (L_{\mathbf{X}}\boldsymbol{\omega})(\mathbf{X}_1, \dots, \mathbf{X}_p) - d(i_{\mathbf{X}}\boldsymbol{\omega})(\mathbf{X}_1, \dots, \mathbf{X}_p).$$

For the first term on the right-hand side, we use Eq. (28.36). For the second term, we use the induction hypothesis because $i_{\mathbf{X}}\boldsymbol{\omega}$ is a $(p-1)$ -form. A straightforward manipulation then leads to the desired result. \square

Example 28.5.12 Let $\mathbf{p} = p_{\alpha}dx^{\alpha}$ be the momentum one-form and write the electromagnetic field tensor as⁹ $\mathbf{F} = \frac{1}{2}F_{\alpha\beta}dx^{\alpha} \wedge dx^{\beta}$, where α and β run over the values 0, 1, 2, and 3 with 0 being the time index. Let

$$\frac{d\mathbf{p}}{d\tau} \equiv \left(\frac{dp_{\alpha}}{d\tau} \right) dx^{\alpha}$$

analysis of the Lorentz force law in the language of forms

be the derivative of momentum with respect to the proper time, τ . Also, let $\mathbf{u} = u^{\beta}\partial_{\beta}$ be the velocity four-vector of a charged particle. Then the **Lorentz force law** can be written simply as $d\mathbf{p}/d\tau = q\mathbf{F}(\mathbf{u}) \equiv -qi_{\mathbf{u}}\mathbf{F}$, where q is the electric charge of the particle whose 4-velocity is \mathbf{u} . Note that \mathbf{F} , a two-form, contracts with \mathbf{u} , a vector, to give a one-form on the RHS. Thus, both sides are of the same type. Let us write this equation in component form:

$$\begin{aligned} \frac{dp_{\alpha}}{d\tau} dx^{\alpha} &= -q \frac{1}{2} F_{\alpha\beta} i_{\mathbf{u}}(dx^{\alpha} \wedge dx^{\beta}) = -\frac{1}{2} q F_{\alpha\beta} (u^{\gamma} \delta_{\gamma\mu}^{\alpha\beta} dx^{\mu}) \\ &= \frac{1}{2} q F_{\alpha\beta} u^{\gamma} (\delta_{\gamma}^{\alpha} \delta_{\mu}^{\beta} - \delta_{\mu}^{\alpha} \delta_{\gamma}^{\beta}) dx^{\mu} \\ &= \frac{1}{2} q F_{\alpha\beta} (u^{\beta} dx^{\alpha} - u^{\alpha} dx^{\beta}) \\ &= \frac{1}{2} q (F_{\alpha\beta} - F_{\beta\alpha}) u^{\beta} dx^{\alpha} = (q F_{\alpha\beta} u^{\beta}) dx^{\alpha}. \end{aligned} \quad (28.41)$$

Equating the components on both sides, we get $dp_{\alpha}/d\tau = q F_{\alpha\beta} u^{\beta}$, which may be familiar to the reader. To make the equation even more familiar, consider the component $\alpha = 1$,

$$\frac{dp_1}{d\tau} = q F_{1\beta} u^{\beta} = q [F_{10} u^0 + F_{12} u^2 + F_{13} u^3], \quad (28.42)$$

⁹The factor $\frac{1}{2}$ is introduced here to avoid restricting the sum over α and β .

and recall that $u^\alpha = dx^\alpha/d\tau$, where

$$(d\tau)^2 = (dt)^2 - (dx^1)^2 - (dx^2)^2 - (dx^3)^2 = (dt)^2(1 - v^2)$$

and $\mathbf{v} = (dx^1/dt, dx^2/dt, dx^3/dt)$ is the 3-velocity of the particle. Since $x^0 = t$, we get

$$u^0 = \frac{dt}{d\tau} = \frac{1}{\sqrt{1-v^2}}, \quad u^i = \frac{dx^i}{d\tau} = \frac{v_i}{\sqrt{1-v^2}} \quad \text{for } i = 1, 2, 3.$$

Substituting this in (28.42) and remembering that $F_{10} = -F_{01} = E_1$, $F_{12} = B_3$, and $F_{13} = -F_{31} = -B_2$, we obtain

$$\frac{dp_1}{dt\sqrt{1-v^2}} = q \left[E_1 \frac{1}{\sqrt{1-v^2}} + B_3 \frac{v_2}{\sqrt{1-v^2}} - B_2 \frac{v_3}{\sqrt{1-v^2}} \right],$$

or

$$\frac{dp_1}{dt} = q[E_1 + (v_2 B_3 - v_3 B_2)] = [q(\mathbf{E} + \mathbf{v} \times \mathbf{B})]_1.$$

The other components are obtained similarly. Thus, in vector form we have

$$\frac{d\mathbf{p}}{dt} = q(\mathbf{E} + \mathbf{v} \times \mathbf{B}),$$

where \mathbf{p} now represents the 3-momentum of the particle. This is the Lorentz force law for electromagnetism in its familiar form. Again, note the simplification offered by the language of forms.

A combination that is very useful is that of the exterior derivative and the Hodge star operator. Recall that the latter is defined by

$$*(dx^{i_1} \wedge \cdots \wedge dx^{i_p}) = \frac{1}{(m-p)!} \epsilon_{i_{p+1} \dots i_m}^{i_1 \dots i_p} dx^{i_{p+1}} \wedge \cdots \wedge dx^{i_m}, \quad (28.43)$$

where m is the dimension of the manifold.

Example 28.5.13 Let us calculate $*\mathbf{F}$ and $d(*\mathbf{F})$ where $\mathbf{F} = \frac{1}{2} F_{\alpha\beta} dx^\alpha \wedge dx^\beta$ is the electromagnetic field tensor. We have

$$*\mathbf{F} = * \left(\frac{1}{2} F_{\alpha\beta} dx^\alpha \wedge dx^\beta \right) = \frac{1}{2} F_{\alpha\beta} *(dx^\alpha \wedge dx^\beta) = \frac{1}{2} F_{\alpha\beta} \frac{1}{2!} \epsilon_{\mu\nu}^{\alpha\beta} dx^\mu \wedge dx^\nu$$

and

$$d(*\mathbf{F}) = d \left(\frac{1}{4} F_{\alpha\beta} \epsilon_{\mu\nu}^{\alpha\beta} dx^\mu \wedge dx^\nu \right) = \frac{1}{4} \epsilon_{\mu\nu}^{\alpha\beta} F_{\alpha\beta,\gamma} dx^\gamma \wedge dx^\mu \wedge dx^\nu,$$

where $F_{\alpha\beta,\gamma} \equiv \partial F_{\alpha\beta} / \partial x^\gamma$. We can now use the components $F_{j0} = E_j$, $F_{12} = B_3$, $F_{13} = -B_2$, and $F_{23} = B_1$ to write $d(*\mathbf{F})$ in terms of \mathbf{E} and \mathbf{B} . After a long but straightforward calculation, we obtain

$$\begin{aligned}
 d(*\mathbf{F}) &= \left[\left(\frac{\partial \mathbf{E}}{\partial t} - \nabla \times \mathbf{B} \right)_z \right] dt \wedge dx \wedge dy \\
 &\quad + \left[\left(\frac{\partial \mathbf{E}}{\partial t} - \nabla \times \mathbf{B} \right)_y \right] dt \wedge dz \wedge dx \\
 &\quad + \left[\left(\frac{\partial \mathbf{E}}{\partial t} - \nabla \times \mathbf{B} \right)_x \right] dt \wedge dy \wedge dz + (\nabla \cdot \mathbf{E}) dx \wedge dy \wedge dz.
 \end{aligned}
 \tag{28.44}$$

The inhomogeneous pair of Maxwell’s equations is

$$\nabla \times \mathbf{B} = \frac{\partial \mathbf{E}}{\partial t} + 4\pi \mathbf{J}, \quad \nabla \cdot \mathbf{E} = 4\pi \rho,
 \tag{28.45}$$

where ρ and \mathbf{J} are charge and current densities, respectively. We can put these two densities together to form a four-current one-form with ρ as the zeroth component: $\mathfrak{J} = J_\alpha dx^\alpha$. Thus,

Maxwell’s inhomogeneous equations in the language of forms

$$\begin{aligned}
 *\mathfrak{J} &= J_\alpha (*dx^\alpha) = J_\alpha \frac{1}{3!} \epsilon_{\mu\nu\rho}^\alpha dx^\mu \wedge dx^\nu \wedge dx^\rho \\
 &= J_0 dx \wedge dy \wedge dz + J_x dt \wedge dy \wedge dz + J_y dt \wedge dz \wedge dx \\
 &\quad + J_z dt \wedge dx \wedge dy \\
 &= \rho dx \wedge dy \wedge dz - J^x dt \wedge dy \wedge dz - J^y dt \wedge dz \wedge dx \\
 &\quad - J^z dt \wedge dx \wedge dy,
 \end{aligned}
 \tag{28.46}$$

where we have used the facts that $\rho = J^0 = J_0$ and $\mathbf{J} = (J^x, J^y, J^z) = -(J_x, J_y, J_z)$.

Comparing Eqs. (28.44), (28.45), and (28.46), we note that

Box 28.5.14 *In the language of forms, the inhomogeneous pair of Maxwell’s equations has the simple appearance $d(*\mathbf{F}) = 4\pi(*\mathfrak{J})$.*

Problem 28.15 shows that the relation $d^2\omega = 0$ is equivalent—at least in \mathbb{R}^3 —to the vanishing of the curl of the gradient and the divergence of the curl. It is customary in physics to try to go backwards as well, that is, given that $\nabla \times \mathbf{E} = 0$, to assume that $\mathbf{E} = \nabla f$ for some function f . Similarly, we want to believe that $\nabla \cdot \mathbf{B} = 0$ implies that $\mathbf{B} = \nabla \times \mathbf{A}$.

closed and exact forms

What is the analogue of the above statement for a general p -form? A form ω that satisfies $d\omega = 0$ is called a **closed form**. An **exact form** is one that can be written as the exterior derivative of another form. Thus, *every exact form is automatically closed*. This is the **Poincaré lemma**. The converse of this lemma is true only if the region of definition of the form is topologically simple, as explained in the following.

regions that are contractable to a point

Consider a p -form ω defined on a region U of a manifold M . If all closed curves in U can be shrunk to a point in U without encountering any points at which ω is ill-defined, we say that U is **contractable** to a point. If ω is not

defined for a point P on M , then any U that contains P is not contractable to a point. We can now state the converse of the Poincaré lemma (for a proof, see [Bish 80, p. 175]):

Theorem 28.5.15 (Converse of the Poincaré lemma) *Let U be a region in a manifold M such that U is contractable to a point. Let ω be a p -form on U such that $d\omega = 0$. Then there exists a $(p - 1)$ -form η on U such that $\omega = d\eta$.*

converse of the Poincaré lemma

Example 28.5.16 The electromagnetic field tensor $\mathbf{F} = \frac{1}{2}F_{\alpha\beta}dx^\alpha \wedge dx^\beta$ is a two-form that satisfies $d\mathbf{F} = 0$. The converse of the Poincaré lemma says that if \mathbf{F} is well behaved in a region U of \mathbb{R}^4 , then there must exist a one-form η such that $\mathbf{F} = d\eta$.

Let us write this one-form in terms of coordinates as $\eta = A_\alpha dx^\alpha$. Then $d\eta = A_{\alpha,\beta}dx^\beta \wedge dx^\alpha$, and we have

$$\begin{aligned} \frac{1}{2}F_{\alpha\beta}dx^\alpha \wedge dx^\beta &= A_{\beta,\alpha}dx^\alpha \wedge dx^\beta \\ \Rightarrow \frac{1}{2}(F_{\alpha\beta} - A_{\beta,\alpha} + A_{\alpha,\beta})dx^\alpha \wedge dx^\beta &= 0. \end{aligned}$$

Since $dx^\alpha \wedge dx^\beta$ are linearly independent and their coefficients are antisymmetric, each of the latter must vanish. Thus,

$$F_{\alpha\beta} = A_{\beta,\alpha} - A_{\alpha,\beta} = \frac{\partial A_\beta}{\partial x^\alpha} - \frac{\partial A_\alpha}{\partial x^\beta}.$$

The four-vector A^α is simply the four-potential of relativistic electromagnetic theory.

Note that the $(p - 1)$ -form of Theorem 28.5.15 is not unique. In fact, if α is any $(p - 2)$ -form, then ω can be written as

gauge invariance in the language of forms

$$\omega = d(\eta + d\alpha)$$

because $d(d\alpha)$ is identical to zero. This freedom of choice in selecting η is called **gauge invariance**, and its generalization plays an important role in the physics of fundamental interactions.¹⁰

Historical Notes

Jules Henri Poincaré (1854–1912): The development of mathematics in the nineteenth century began under the shadow of a giant, Carl Friedrich Gauss; it ended with the domination by a genius of similar magnitude, Henri Poincaré. Both were universal mathematicians in the supreme sense, and both made important contributions to astronomy and mathematical physics. If Poincaré’s discoveries in number theory do not equal those of Gauss, his achievements in the theory of functions are at least on the same level—even when one takes into account the theory of elliptic and modular functions, which must be credited to Gauss and which represents in that field his most important discovery, although it was not published during his lifetime. If Gauss was the initiator in the theory



Jules Henri Poincaré
1854–1912

¹⁰Gauge invariance and gauge theories are discussed in detail in Chap. 35.

of differentiable manifolds, Poincaré played the same role in *algebraic topology*. Finally, Poincaré remains the most important figure in the theory of differential equations and the mathematician who after Newton did the most remarkable work in celestial mechanics. Both Gauss and Poincaré had very few students and liked to work alone; but the similarity ends there. Where Gauss was very reluctant to publish his discoveries, Poincaré's list of papers approaches five hundred, which does not include the many books and lecture notes he published as a result of his teaching at the Sorbonne.

Poincaré's parents both belonged to the upper middle class, and both their families had lived in Lorraine for several generations. His paternal grandfather had two sons: Léon, Henri's father, was a physician and a professor of medicine at the University of Nancy; Antoine had studied at the *École Polytechnique* and rose to high rank in the engineering corps. One of Antoine's sons, Raymond, was several times prime minister and was president of the French Republic during World War I; the other son, Lucien, occupied high administrative functions in the university. Poincaré's mathematical ability became apparent while he was still a student in the *lycée*. He won first prizes in the *concours général* (a competition among students from all French *lycées*) and in 1873 entered the *École Polytechnique* at the top of his class; his professor at Nancy is said to have referred to him as a "monster of mathematics." After graduation, he followed courses in engineering at the *École des Mines* and worked briefly as an engineer while writing his thesis for the doctorate in mathematics which he obtained in 1879. Shortly afterward he started teaching at the University of Caen, and in 1881 he became a professor at the University of Paris, where he taught until his untimely death in 1912. At the early age of thirty-three he was elected to the *Académie des Sciences* and in 1908 to the *Académie Française*. He was also the recipient of innumerable prizes and honors both in France and abroad.

Before he was thirty years of age, Poincaré became world famous with his epoch-making discovery of the "automorphic functions" of one complex variable (or, as he called them, the "fuchsian" and "kleinean" functions). Much has been written on the "competition" between C.F. Klein and Poincaré in the discovery of automorphic functions. However, Poincaré's ignorance of the mathematical literature when he started his researches is almost unbelievable. He hardly knew anything on the subject beyond Hermite's work on the modular functions; he certainly had never read Riemann, and by his own account had not even heard of the "Dirichlet principle," which he was to use in such imaginative fashion a few years later. Nevertheless, Poincaré's idea of associating a fundamental domain to any fuchsian group does not seem to have occurred to Klein, nor did the idea of "using" non-Euclidean geometry, which is never mentioned in his papers on modular functions up to 1880.

Poincaré was one of the few mathematicians of his time who understood and admired the work of Lie and his continuators on "continuous groups," and in particular the only mathematician who in the early 1900s realized the depth and scope of E. Cartan's papers. In 1899 Poincaré proved what is now called the *Poincaré-Birkhoff-Witt theorem* which has become fundamental in the modern theory of Lie algebras. The theory of differential equations and its applications to dynamics was clearly at the center of Poincaré's mathematical thought; from his first (1878) to his last (1912) paper, he attacked the theory from all possible angles and very seldom let a year pass without publishing a paper on the subject. The most extraordinary production of Poincaré's, also dating from his prodigious period of creativity (1880–1883) (reminding us of Gauss's *Tagebuch* of 1797–1801), is the qualitative theory of differential equations. It is one of the few examples of a mathematical theory that sprang apparently out of nowhere and that almost immediately reached perfection in the hands of its creator. Everything was new in the first two of the four big papers that Poincaré published on the subject between 1880 and 1886.

For more than twenty years Poincaré lectured at the Sorbonne on mathematical physics; he gave himself to that task with his characteristic thoroughness and energy, with the result that he became an expert in practically all parts of theoretical physics, and published more than seventy papers and books on the most varied subjects, with a predilection for the theories of light and of electromagnetic waves. On two occasions he played an important part in the development of the new ideas and discoveries that revolutionized physics at the end of the nineteenth century. His remark on the possible connection between X-rays and the phenomenon of phosphorescence was the starting point of H. Becquerel's experiments that led him to the discovery of radioactivity. On the other hand, Poincaré

was active from 1899 on in the discussions concerning Lorentz's theory of the electron; Poincaré was the first to observe that the Lorentz transformations form a group; and many physicists consider that Poincaré shares with Lorentz and Einstein the credit for the invention of the special theory of relativity. The main leitmotiv of Poincaré's mathematical work is clearly the idea of "continuity": Whenever he attacks a problem in analysis, we almost immediately see him investigating what happens when the conditions of the problem are allowed to vary continuously. He was therefore bound to encounter at every turn what we now call *topological* problems. He himself said in 1901, "Every problem I had attacked led me to *Analysis situs*," particularly the researches on differential equations and on the periods of multiple integrals. Starting in 1894 he inaugurated in a remarkable series of six papers—written during a period of ten years—the modern methods of algebraic topology.

Whereas Poincaré has been accused of being too conservative in physics, he certainly was very open-minded regarding new mathematical ideas. The quotations in his papers show that he read extensively, if not systematically, and was aware of all the latest developments in practically every branch of mathematics. He was probably the first mathematician to use Cantor's theory of sets in analysis. Up to a certain point, he also looked with favor on the axiomatic trend in mathematics, as it was developing toward the end of the nineteenth century, and he praised Hilbert's *Grundlagen der Geometrie*. However, he obviously had a blind spot regarding the formalization of mathematics, and poked fun repeatedly at the efforts of the disciples of Peano and Russell in that direction; but, somewhat paradoxically, his criticism of the early attempts of Hilbert was probably the starting point of some of the most fruitful of the later developments of metamathematics. Poincaré stressed that Hilbert's point of view of defining objects by a system of axioms was admissible only if one could prove a priori that such a system did not imply contradiction, and it is well known that the proof of noncontradiction was the main goal of the theory that Hilbert founded after 1920. Poincaré seems to have been convinced that such attempts were hopeless, and K. Gödel's theorem proved him right.

28.6 Integration on Manifolds

We mentioned in Chap. 26 that certain exterior products are interpreted as volume elements. We now exploit this notion and define integration on manifolds. Starting with \mathbb{R}^n , considered as a manifold, we define the integral of an n -form ω as follows. Choose a coordinate system $\{x^i\}_{i=1}^n$ in \mathbb{R}^n , write $\omega = f dx^1 \wedge \cdots \wedge dx^n$, and define the integral of the n -form as

integration of differential forms in \mathbb{R}^n

$$\int_{\mathbb{R}^n, x} \omega \equiv \int_{\mathbb{R}^n} f(x^1, \dots, x^n) dx^1 \dots dx^n,$$

where to avoid dealing with infinities, one assumes that f vanishes outside a bounded region. The second symbol in the lower part of the integral sign indicates the variables of integration. Let us now change the coordinates, say to $\{y^j\}_{j=1}^n$. Using Eq. (28.17), which gives the transformation rule for 1-forms when changing coordinates, and Eq. (2.32), which defines the determinant in terms of n -forms, we obtain

$$\omega = f dx^1 \wedge \cdots \wedge dx^n = f \det\left(\frac{\partial x^i}{\partial y^j}\right) dy^1 \wedge \cdots \wedge dy^n,$$

where f is now understood to be a function of the y 's through the x 's. So, in terms of the new coordinates, the integral becomes

$$\int_{\mathbb{R}^n, \mathbf{y}} \omega = \int_{\mathbb{R}^n} f(x^1(\mathbf{y}), \dots, x^n(\mathbf{y})) \det\left(\frac{\partial x^i}{\partial y^j}\right) dy^1 \wedge \dots \wedge dy^n.$$

If we had the absolute value of the Jacobian in the integral, the two sides would be equal. So, all we can say at this point is

$$\int_{\mathbb{R}^n, \mathbf{y}} \omega = \pm \int_{\mathbb{R}^n, \mathbf{x}} \omega.$$

This discussion is analogous to our discussion of orientation in vector spaces (see Sect. 26.3.1).

We therefore distinguish between two kinds of coordinate transformations: If the Jacobian determinant is positive, we say that the coordinate transformation is **orientation preserving**. Otherwise, the transformation is called **orientation reversing**.

Our ability to integrate functions on \mathbb{R}^n depends crucially on the fact that volume elements do not change sign at any point of \mathbb{R}^n . If this were not so, we could find a finite (albeit small) region of space—in the vicinity of the point at which the volume element changes sign—whose volume would be zero. This property of \mathbb{R}^n is the content of the following:

orientable manifolds

Definition 28.6.1 A manifold M of dimension n is called **orientable** if it has a nowhere vanishing n -form.

Any two nonvanishing n -forms ω and ω' on an orientable manifold are related by a nowhere-vanishing function: $\omega' = h\omega$. Clearly, h has to be either positive or negative everywhere. ω and ω' are said to be *equivalent* if h is positive. Thus, the nonvanishing n -forms on an orientable manifold fall into two classes, all members of each class being equivalent to one another, and a member of one class being related to a member of the other class via a negative function. Each class is called an **orientation** on M .

Given an orientation, an n -form ω , and a chart $\{U_\alpha, \phi_\alpha\}$ on M , we define

$$\int_M \omega \equiv \sum_\alpha \int_{\mathbb{R}^n} (\phi_\alpha^{-1})^* (\omega|_\alpha), \quad (28.47)$$

where $(\phi_\alpha^{-1})^*$ is the pullback of $\phi_\alpha^{-1} : \mathbb{R}^n \rightarrow M$, so that it maps n -forms on M to n -forms on \mathbb{R}^n ; $\omega|_\alpha$ is the restriction of ω to U_α , and the sum over α is assumed to exist. This amounts to saying that the region in M on which ω is defined is finite, or that ω has **compact support**.

Compact support

We note that the RHS of Eq. (28.47) is an integration on \mathbb{R}^n that appears to depend on the choice of coordinate functions. However, it can be shown that the integral is independent of such choice. In practice, one chooses a coordinate patch and transfers the integration to \mathbb{R}^n , where the process is familiar.

“volume” of a manifold

If we choose a coordinate patch $\{x^i\}_{i=1}^n$ and integrate $dx^1 \wedge \dots \wedge dx^n$ according to Eq. (28.47), we obtain the “volume” of the manifold M . If M is compact, this volume will be finite.¹¹

¹¹Recall from Chap. 17 that a subset of \mathbb{R}^n is compact iff it is closed and bounded. It is a good idea to keep this in mind as a paradigm of compact spaces.

Theorem 28.6.2 (Stokes' theorem) *Let M be an oriented n -manifold. Let ω be an $(n - 1)$ -form with compact support. Then* Stokes' Theorem

$$\int_M d\omega = 0$$

Proof From Eq. (28.47), we have

$$\int_M d\omega = \sum_{\alpha} \int_{\mathbb{R}^n} (\phi_{\alpha}^{-1})^*(d\omega|_{\alpha}) = \sum_{\alpha} \int_{\mathbb{R}^n} d((\phi_{\alpha}^{-1})^*\omega|_{\alpha})$$

where in the last equality, we used item 5 of Theorem 28.5.3. Now $(\phi_{\alpha}^{-1})^*\omega|_{\alpha}$ is an $(n - 1)$ -form on \mathbb{R}^n . If β is such a form, it can be written as

$$\beta = \beta_i dx^1 \wedge \dots \wedge d\hat{x}^i \wedge \dots \wedge dx^n$$

and $d\beta = \sum_{i=1}^n (-1)^{i-1} \partial_i \beta_i dx^1 \wedge \dots \wedge dx^n$. Therefore,

$$\begin{aligned} \int_{\mathbb{R}^n} d\beta &= \sum_{i=1}^n \int_{\mathbb{R}^n} (-1)^{i-1} \partial_i \beta_i dx^1 \wedge \dots \wedge dx^n \\ &\equiv \sum_{i=1}^n (-1)^{i-1} \int_{\mathbb{R}^n} \frac{\partial \beta_i}{\partial x^i} dx^1 \dots dx^n \\ &= \sum_{i=1}^n (-1)^{i-1} \int_{\mathbb{R}^{n-1}} \left(\int_{\mathbb{R}} \frac{\partial \beta_i}{\partial x^i} dx^i \right) dx^1 \dots d\hat{x}^i \dots dx^n \\ &= \sum_{i=1}^n (-1)^{i-1} \int_{\mathbb{R}^{n-1}} (\beta_i|_{x^i=-\infty}^{x^i=\infty}) dx^1 \dots d\hat{x}^i \dots dx^n. \end{aligned}$$

The term in parentheses is zero because β has compact support and all its components must vanish at infinity. □

A manifold may have a **boundary** ∂M , which is an $(n - 1)$ -dimensional submanifold of M , every point of which has a coordinate neighborhood in which one of the coordinates is zero. For example, the xy -plane is the boundary of the lower space on which $z = 0$. As another example, consider an open set U of an n -manifold M . Then U is also an n -manifold, and its boundary ∂U is an $(n - 1)$ -dimensional manifold. If M (and therefore, U) is oriented, then ∂U inherits an orientation from U . There is another version of the Stokes' Theorem for manifolds with boundary, which we state without proof.

Theorem 28.6.3 *Let U be an oriented n -manifold with boundary ∂U . Let ω be an $(n - 1)$ -form with compact support. Then*

$$\int_U d\omega = \int_{\partial U} \omega$$

Stokes' Theorem for manifolds with boundary

Combining the exterior differential with the Hodge star operator, we get a useful quantity.

Definition 28.6.4 The **codifferential** δ is a map $\delta : \Lambda^p(M) \rightarrow \Lambda^{p-1}(M)$ given by

$$\delta\omega = (-1)^{v+1}(-1)^{n(p+1)} * d * \omega$$

Codifferential defined

where n is the dimension of M . If ω is a 0-form, i.e., a function f , then the definition leads to $\delta f = 0$. Furthermore, since $** = \pm 1$, $\delta^2 \equiv 0$.

If M has a metric, i.e., a nondegenerate symmetric bilinear form \mathbf{g} defined smoothly on each point of M , and \mathbf{g} does not vary over M , then we have the following:

Proposition 28.6.5 If $\omega = \frac{1}{p!} \omega_{i_1 \dots i_p} dx^{i_1} \wedge \dots \wedge dx^{i_p}$ is a p -form on an n -manifold M with constant metric \mathbf{g} , then

$$\delta\omega = \frac{(-1)^p}{(p-1)!} \partial_i \omega_{i_1 \dots i_{p-1}}^i dx^{i_1} \wedge \dots \wedge dx^{i_{p-1}}$$

where $\partial_i \omega_{i_1 \dots i_{p-1}}^i = g^{i_p} \partial_i \omega_{i_1 \dots i_{p-1} i_p} = \partial_i (g^{i_p} \omega_{i_1 \dots i_{p-1} i_p})$.

Proof Start with the definition of δ and the Hodge star operator:

$$\begin{aligned} \delta\omega &= (-1)^{v+1}(-1)^{n(p+1)} * d * \omega \\ &= \frac{(-1)^{v+1}(-1)^{n(p+1)}}{p!(n-p)!} * d(\omega^{i_1 \dots i_p} \epsilon_{i_1 \dots i_n} dx^{i_{p+1}} \wedge \dots \wedge dx^{i_n}). \end{aligned}$$

Now note that d differentiates only the function $\omega^{i_1 \dots i_p}$ because $d^2 = 0$. Differentiating and applying $*$ afterwards, we get

$$\begin{aligned} \delta\omega &= \frac{(-1)^{v+1}(-1)^{n(p+1)}}{p!(n-p)!} \epsilon_{i_1 \dots i_n} \partial_i \omega^{i_1 \dots i_p} * (dx^i \wedge dx^{i_{p+1}} \wedge \dots \wedge dx^{i_n}) \\ &= \frac{(-1)^{v+1}(-1)^{n(p+1)}}{p!(n-p)!} \epsilon_{i_1 \dots i_n} \partial_i \omega^{i_1 \dots i_p} \\ &\quad \times \frac{1}{(p-1)!} g^{i_j p} g^{i_{p+1} j_{p+1}} \dots g^{i_n j_n} \epsilon_{j_p \dots j_n j_1 \dots j_{p-1}} dx^{j_1} \wedge \dots \wedge dx^{j_{p-1}}. \end{aligned}$$

Rearranging the indices of the ϵ ,

$$\epsilon_{j_p \dots j_n j_1 \dots j_{p-1}} = (-1)^{(n-p+1)(p-1)} \epsilon_{j_1 \dots j_n},$$

manipulating the powers of -1 , noting that $A^k B_k = A_k B^k$, and using the fact that g^{lm} are constant,¹² we rewrite the last expression as

¹²Reader, see where this fact is used!

$$\begin{aligned}
\delta\omega &= \frac{(-1)^{v+1}(-1)^{(p-1)^2}}{p!(n-p)!(p-1)!} \epsilon^{i_1 \dots i_n} \epsilon_{j_1 \dots j_n} \partial_i \omega_{i_1 \dots i_p} g^{ij_p} g_{i_{p+1}}^{j_{p+1}} \dots g_{i_n}^{j_n} dx^{j_1} \wedge \dots \\
&\quad \wedge dx^{j_{p-1}} \\
&= -\frac{(-1)^{p-1}}{p!(n-p)!(p-1)!} \delta_{j_1 \dots j_n}^{i_1 \dots i_n} \partial_i \omega_{i_1 \dots i_p} g^{ij_p} \delta_{i_{p+1}}^{j_{p+1}} \dots \delta_{i_n}^{j_n} dx^{j_1} \wedge \dots \\
&\quad \wedge dx^{j_{p-1}},
\end{aligned}$$

where we used Eq. (26.44), the fact that $(-1)^{m^2} = (-1)^m$ for any integer m and that $g_j^i = \delta_j^i$. The last expression is now reduced to

$$\begin{aligned}
\delta\omega &= -\frac{(-1)^{p-1}}{p!(n-p)!(p-1)!} \delta_{j_1 \dots j_{p+1} \dots i_n}^{i_1 \dots i_p i_{p+1} \dots i_n} \partial_i \omega_{i_1 \dots i_p} g^{ij_p} dx^{j_1} \wedge \dots \wedge dx^{j_{p-1}} \\
&= -\frac{(-1)^{p-1}}{p!(p-1)!} \delta_{j_1 \dots j_p}^{i_1 \dots i_p} \partial_i \omega_{i_1 \dots i_p} g^{ij_p} dx^{j_1} \wedge \dots \wedge dx^{j_{p-1}} \\
&= -\frac{(-1)^{p-1}}{(p-1)!} \partial_i \omega_{j_1 \dots j_p} g^{ij_p} dx^{j_1} \wedge \dots \wedge dx^{j_{p-1}},
\end{aligned}$$

where we used Eq. (26.47) in the first equality and Eq. (26.50) in the last. \square

If M has a metric, then a metric $\tilde{\mathbf{g}}$ can be defined on $\Lambda^p(M)$ in exact analogy with Definition 26.3.13, and we have the following:

Theorem 28.6.6 *Let M be an oriented n -manifold with volume element μ and metric \mathbf{g} . Let $\alpha \in \Lambda^p(M)$ and $\beta \in \Lambda^{p+1}(M)$ such that $\alpha \wedge \beta$ has compact support. Then*

$$\int_M \tilde{\mathbf{g}}(\alpha, \delta\beta)\mu = \int_M \tilde{\mathbf{g}}(d\alpha, \beta)\mu$$

Proof From Theorem 26.6.4, we have

$$\begin{aligned}
\tilde{\mathbf{g}}(\alpha, \delta\beta)\mu &= \alpha \wedge * \delta\beta = \alpha \wedge * ((-1)^{v+1} (-1)^{n(p+2)} * d * \beta) \\
&= (-1)^{v+1} (-1)^{n(p+2)} (-1)^v (-1)^{p(n-p)} \alpha \wedge d * \beta \\
&= -(-1)^p \alpha \wedge d * \beta
\end{aligned}$$

because $(-1)^{p^2} = (-1)^{-p^2} = (-1)^p$ for any integer p . Hence,

$$\tilde{\mathbf{g}}(d\alpha, \beta)\mu - \tilde{\mathbf{g}}(\alpha, \delta\beta)\mu = d\alpha \wedge * \beta + (-1)^p \alpha \wedge d * \beta = d(\alpha \wedge * \beta)$$

and the integral over M of the right-hand side is zero by Stokes' Theorem. \square

28.7 Symplectic Geometry

Mechanics stimulated a great deal of dialogue between physics and mathematics in the latter part of the nineteenth century and the beginning of the twentieth. The branch of mathematics that benefited the most out of this

dialog is the theory of differentiable manifolds, whose tribute back to mechanics has been the most beautiful language in which the latter can express itself, the language of symplectic geometry. All the discussion of symplectic vector spaces of the last chapter can be carried over to the tangent spaces of a manifold and patched together by the differentiable structure of the manifold.

symplectic form,
symplectic structure,
and symplectic manifold
defined

Definition 28.7.1 A **symplectic form** (or a **symplectic structure**) on a manifold M is a nondegenerate, closed 2-form ω on M . A **symplectic manifold** (M, ω) is a manifold M together with a symplectic form ω on M . We define the map $\flat : \mathcal{X}(M) \rightarrow \mathcal{X}^*(M)$ by

$$\flat(\mathbf{X}) \equiv \mathbf{X}^\flat = i_{\mathbf{X}}\omega = \omega^\flat(\mathbf{X})$$

and the map $\sharp : \mathcal{X}^*(M) \rightarrow \mathcal{X}(M)$ as the inverse of \flat .

Chapter 26 identified some special basis, the canonical basis, in which the symplectic form of a symplectic vector space took on a simple expression. The analogue of such a basis exists in a symplectic manifold. The reader should keep in mind that this existence is not automatic, because although one can find such bases at every point of the manifold, the smooth patching up of all such bases to cover the entire manifold is not trivial and is the content of the following important theorem, which we state without proof (see [Abra 85, p. 175]):

Darboux theorem

Theorem 28.7.2 (Darboux) *Suppose ω is a 2-form on a $2n$ -dimensional manifold M . Then $d\omega = 0$ if and only if there is a chart (U, φ) at each $P \in M$ such that $\varphi(P) = \mathbf{0}$ and*

$$\omega = \sum_{i=1}^n dx^i \wedge dy^i,$$

where $x^1, \dots, x^n, y^1, \dots, y^n$ are coordinates on U . Furthermore, on such a chart, the volume element μ_ω is

$$\mu_\omega = dx^1 \wedge \dots \wedge dx^n \wedge dy^1 \wedge \dots \wedge dy^n.$$

symplectic charts,
canonical coordinates,
and canonical
transformations

Definition 28.7.3 The charts guaranteed by Darboux's theorem are called **symplectic charts**, and the coordinates x^i, y^i are called **canonical coordinates**. If (M, ω) and (N, ρ) are symplectic manifolds, then a \mathcal{C}^∞ map $f : M \rightarrow N$ is called **symplectic**, or a **canonical transformation**, if $f^*\rho = \omega$.

Example 28.7.4 In this example, we derive a formula that gives the action of ω^\flat and ω^\sharp in terms of components of vectors and 1-forms in canonical coordinates. Let

Coordinate
representation of sharp
and flat maps

$$\mathbf{Z} \equiv X^i \frac{\partial}{\partial x^i} + Y^i \frac{\partial}{\partial y^i}$$

be a vector field. When ω^b acts on \mathbf{Z} , it gives a 1-form, which we write as $\omega^b(\mathbf{Z}) \equiv U_k dx^k + W_k dy^k$. To find the unknowns U_k and W_k , we let both sides act on coordinate basis vectors. For the RHS, we get

$$(U_k dx^k + W_k dy^k) \left(\frac{\partial}{\partial x^j} \right) = \underbrace{U_k dx^k \left(\frac{\partial}{\partial x^j} \right)}_{=\delta_j^k} + \underbrace{W_k dy^k \left(\frac{\partial}{\partial x^j} \right)}_{=0} = U_j$$

and

$$(U_k dx^k + W_k dy^k) \left(\frac{\partial}{\partial y^j} \right) = W_j.$$

For the LHS, we obtain

$$\begin{aligned} & \left[\omega^b \left(X^i \frac{\partial}{\partial x^i} + Y^i \frac{\partial}{\partial y^i} \right) \right] \left(\frac{\partial}{\partial x^j} \right) \\ &= X^i \left[\omega^b \left(\frac{\partial}{\partial x^i} \right) \right] \left(\frac{\partial}{\partial x^j} \right) + Y^i \left[\omega^b \left(\frac{\partial}{\partial y^i} \right) \right] \left(\frac{\partial}{\partial x^j} \right) \\ &= X^i \omega \left(\frac{\partial}{\partial x^i}, \frac{\partial}{\partial x^j} \right) + Y^i \omega \left(\frac{\partial}{\partial y^i}, \frac{\partial}{\partial x^j} \right). \end{aligned}$$

But

$$\begin{aligned} \omega \left(\frac{\partial}{\partial x^i}, \frac{\partial}{\partial x^j} \right) &= \left(\sum_{k=1}^n dx^k \wedge dy^k \right) \left(\frac{\partial}{\partial x^i}, \frac{\partial}{\partial x^j} \right) \\ &= \sum_{k=1}^n dx^k \left(\frac{\partial}{\partial x^i} \right) \underbrace{dy^k \left(\frac{\partial}{\partial x^j} \right)}_{=0} \\ &\quad - \sum_{k=1}^n dx^k \left(\frac{\partial}{\partial x^j} \right) \underbrace{dy^k \left(\frac{\partial}{\partial x^i} \right)}_{=0} = 0 \end{aligned}$$

and

$$\begin{aligned} \omega \left(\frac{\partial}{\partial y^i}, \frac{\partial}{\partial x^j} \right) &= \left(\sum_{k=1}^n dx^k \wedge dy^k \right) \left(\frac{\partial}{\partial y^i}, \frac{\partial}{\partial x^j} \right) \\ &= \sum_{k=1}^n \underbrace{dx^k \left(\frac{\partial}{\partial y^i} \right)}_{=0} \underbrace{dy^k \left(\frac{\partial}{\partial x^j} \right)}_{=0} \\ &\quad - \sum_{k=1}^n \underbrace{dx^k \left(\frac{\partial}{\partial x^j} \right)}_{=\delta_j^k} \underbrace{dy^k \left(\frac{\partial}{\partial y^i} \right)}_{=-\delta_i^k} = -\delta_j^i. \end{aligned}$$

It follows that

$$\left[\omega^b \left(X^i \frac{\partial}{\partial x^i} + Y^i \frac{\partial}{\partial y^i} \right) \right] \left(\frac{\partial}{\partial x^j} \right) = -Y^j.$$

Similarly,

$$\left[\omega^b \left(X^i \frac{\partial}{\partial x^i} + Y^i \frac{\partial}{\partial y^i} \right) \right] \left(\frac{\partial}{\partial y^j} \right) = X^j.$$

Therefore,

$$\omega^b \left(X^i \frac{\partial}{\partial x^i} + Y^i \frac{\partial}{\partial y^i} \right) = -Y^j dx^j + X^j dy^j, \quad (28.48)$$

where a summation over repeated indices is understood.

If we multiply both sides of this equation by ω^\sharp on the left and recall that $\omega^\sharp \omega^b = \mathbf{1}$, we obtain the following equation for the action of ω^\sharp :

$$\omega^\sharp (X^j dx^j + Y^j dy^j) = Y^i \frac{\partial}{\partial x^i} - X^i \frac{\partial}{\partial y^i}. \quad (28.49)$$

Equations (28.48) and (28.49) are very useful in Hamiltonian mechanics.

Our discussion of symplectic transformations of symplectic vector spaces showed that such maps are necessarily isomorphisms. Applied to the present situation, this means that if $f : M \rightarrow N$ is symplectic, then $f_* : \mathcal{T}_P(M) \rightarrow \mathcal{T}_{f(P)}(N)$ is an isomorphism. Theorem 28.3.2, the inverse mapping theorem, now gives the following theorem.

Theorem 28.7.5 *If $f : M \rightarrow N$ is symplectic, then it is a local diffeomorphism.*

Example 28.7.6 Hamiltonian mechanics takes place in the phase space of a system. The phase space is derived from the configuration space as follows. Let (q_1, \dots, q_n) be the generalized coordinates of a mechanical system. They describe an n -dimensional manifold N . The dynamics of the system is described by the (time-independent) Lagrangian L , which is a function of (q^i, \dot{q}^i) . But \dot{q}^i are the components of a vector at (q_1, \dots, q_n) [see Eq. (28.13) and replace γ^i with x^i]. Thus, in the language of manifold theory, a Lagrangian is a function on the tangent bundle, $L : T(N) \rightarrow \mathbb{R}$.

from Lagrangian to
Hamiltonian in the
language of differential
forms

The Hamiltonian is obtained from the Lagrangian by a Legendre transformation: $H = \sum_{i=1}^n p_i \dot{q}^i - L$. The first term can be thought of as a pairing of an element of the tangent space with its dual. In fact, if P has coordinates (q_1, \dots, q_n) , then $\dot{\mathbf{q}} \equiv \dot{q}^i \partial_i \in \mathcal{T}_P(N)$ (with the Einstein summation convention enforced), and if we pair this with the dual vector $p_j dx^j \in \mathcal{T}_P^*(N)$, we obtain the first term in the definition of the Hamiltonian. The effect of the Legendre transformation is to replace \dot{q}^i by p_i as the second set of independent variables. This has the effect of replacing $T(N)$ with $T^*(N)$. Thus

Box 28.7.7 *The manifold of Hamiltonian dynamics, or the phase space, is $T^*(N)$, with coordinates (q^i, p_i) on which the Hamiltonian $H : T^*(N) \rightarrow \mathbb{R}$ is defined.*

$T^*(N)$ is $2n$ -dimensional; so it has the potential of becoming a symplectic manifold. In fact, it can be shown that¹³ the 2-form suggested by Darboux’s theorem,

symplectic 2-form of $T^*(N)$

$$\omega \equiv \sum_{i=1}^n dq^i \wedge dp_i, \tag{28.50}$$

is nondegenerate, and therefore a symplectic form for $T^*(N)$.

The phase space, equipped with a symplectic form, turns into a geometric arena in which Hamiltonian mechanics unfolds. We saw in the above example that a Hamiltonian is a function on the phase space. More generally, if (M, ω) is a symplectic manifold, a Hamiltonian H is a real-valued function, $H : M \rightarrow \mathbb{R}$. Given a Hamiltonian, one can define a vector field as follows. Consider $dH \in T^*(M)$. For a symplectic manifold, there is a natural isomorphism between $T^*(M)$ and $T(M)$, namely, ω^\sharp . The unique vector field \mathbf{X}_H associated with dH is the vector field we are after.

Definition 28.7.8 Let (M, ω) be a symplectic manifold and $H : M \rightarrow \mathbb{R}$ a real-valued function. The vector field

Hamiltonian vector field and Hamiltonian systems defined

$$\mathbf{X}_H \equiv \omega^\sharp(dH) \equiv (dH)^\sharp$$

is called the **Hamiltonian vector field** with **energy function** H . The triplet $(M, \omega, \mathbf{X}_H)$ is called a **Hamiltonian system**.

The significance of the Hamiltonian vector field lies in its integral curve which turns out to be the path of evolution of the system in the phase space. This is shown in the following proposition.

Proposition 28.7.9 *If $(q^1, \dots, q^n, p_1, \dots, p_n)$ are canonical coordinates for ω —so $\omega = \sum dq^i \wedge dp_i$ —then, in these coordinates*

$$\mathbf{X}_H = \frac{\partial H}{\partial p_i} \frac{\partial}{\partial x^i} - \frac{\partial H}{\partial q^i} \frac{\partial}{\partial p_i} \equiv \left(\frac{\partial H}{\partial p_i}, -\frac{\partial H}{\partial q^i} \right). \tag{28.51}$$

¹³Here, we are assuming that the mechanical system in question is nonsingular, by which is meant that there are precisely n independent p_i ’s. There are systems of considerable importance that happen to be singular. Such systems, among which are included all gauge theories such as the general theory of relativity, are called **constrained systems** and are characterized by the fact that ω is degenerate. Although of great interest and currently under intense study, we shall not discuss constrained systems in this book.

Therefore, $(q(t), p(t))$ is an integral curve of \mathbf{X}_H iff Hamilton's equations hold:

$$\frac{\partial q^i}{\partial t} = \frac{\partial H}{\partial p_i}, \quad \frac{\partial p_i}{\partial t} = -\frac{\partial H}{\partial q^i}, \quad i = 1, \dots, n. \quad (28.52)$$

Proof The first part of the proposition follows from

$$dH = \frac{\partial H}{\partial q^i} dq^i + \frac{\partial H}{\partial p_i} dp_i,$$

from the definition of \mathbf{X}_H in terms of dH , and from Eq. (28.49). The second part follows from the definition of integral curve and Eq. (28.19). \square

We called H the energy function; this is for good reason:

conservation of energy in the language of symplectic geometry **Theorem 28.7.10** *Let $(M, \omega, \mathbf{X}_H)$ be a Hamiltonian system and $\gamma(t)$ an integral curve of \mathbf{X}_H . Then $H(\gamma(t))$ is constant in t .*

Proof We show that the time-derivative of $H(\gamma(t))$ is zero:

$$\begin{aligned} \frac{d}{dt} H(\gamma(t)) &= \gamma_{*t}(H) && \text{by Proposition 28.2.4} \\ &= dH(\gamma_{*t}) && \text{by Eq. (28.14)} \\ &= dH(\mathbf{X}_H(\gamma(t))) && \text{by definition of integral curve} \\ &= [\omega^b(\mathbf{X}_H(\gamma(t)))](\mathbf{X}_H(\gamma(t))) && \text{by definition of } \mathbf{X}_H(\gamma(t)) \\ &= \omega(\mathbf{X}_H(\gamma(t)), \mathbf{X}_H(\gamma(t))) && \text{by the definition of } \omega^b \\ &= 0 && \text{because } \omega \text{ is skew-symmetric} \end{aligned}$$

\square

Theorem 28.7.10 is the statement of the conservation of energy.

Historical Notes

Sir William Rowan Hamilton (1805–1865), the fourth of nine children, was mostly raised by an uncle, who quickly realized the extraordinary nature of his young nephew. By the age of five, Hamilton spoke Latin, Greek, and Hebrew, and by the age of nine had added more than a half dozen languages to that list. He was also quite famous for his skill at rapid calculation. Hamilton's introduction to mathematics came at the age of 13, when he studied Clairaut's *Algebra*, a task made somewhat easier as Hamilton was fluent in French by this time. At age 15 he started studying Newton, whose *Principia* spawned an interest in astronomy that would provide a great influence in Hamilton's early career. In 1822, at the age of 18, Hamilton entered Trinity College, Dublin, and in his first year he obtained the top mark in classics. He divided his studies equally between classics and mathematics and in his second year he received the top award in mathematical physics. Hamilton discovered an error in Laplace's *Mécanique céleste*, and as a result, he came to the attention of John Brinkley, the Astronomer Royal of Ireland, who said: "This young man, I do not say will be, but is, the first mathematician of his age." While in his final year as an undergraduate, he presented a memoir entitled *Theory of Systems of Rays* to the Royal Irish Academy in which he planted the seeds of **symplectic geometry**.



Sir William Rowan Hamilton 1805–1865

Hamilton's personal life was marked at first by despondency. Rejected by a college friend's sister, he became ill and nearly suicidal. He was rejected a few years later by another friend's sister and wound up marrying a very timid woman prone to ill health. Hamilton's own personality was much more energetic and humorous, and he easily acquired friends among the literati. His own attempts at poetry, which he himself fancied, were generally considered quite poor. No less an authority than Wordsworth attempted to convince him that his true calling was mathematics, not poetry. Nevertheless, Hamilton maintained close connection with the worlds of literature and philosophy, insisting that the ideas to be gleaned from them were integral parts of his life's work. While Hamilton is best known in physics for his work in dynamics, more of his time was spent on studies in optics and the theory of quaternions. In optics, he derived a function of the initial and final coordinates of a ray and termed it the "characteristic function," claiming that it contained "the whole of mathematical optics." Interestingly, his approach shed no new light on the wave/corpuscular debate (being independent of which view was taken), another appearance of Hamilton's quest for ultimate generality.

In 1833 Hamilton published a study of *vectors* as ordered pairs. He used algebra to study dynamics in *On a General Method in Dynamics* in 1834. The theory of quaternions, on which he spent most of his time, grew from his dissatisfaction with the current state of the theoretical foundation of algebra. He was aware of the description of complex numbers as points in a plane and wondered if any other geometrical representation was possible or if there existed some hypercomplex number that could be represented by three-dimensional points in space. If the latter supposition were true, it would entail a natural algebraic representation of ordinary space. To his surprise, Hamilton found that in order to create a hypercomplex number algebra for which the modulus of a product equaled the product of the two moduli, *four components* were required—hence, quaternions.

Hamilton felt that this discovery would revolutionize mathematical physics, and he spent the rest of his life working on quaternions, including publication of a book entitled *Elements of Quaternions*, which he estimated would be 400 pages long and take two years to write. The title suggests that Hamilton modeled his work on Euclid's *Elements* and indeed this was the case. The book ended up double its intended length and took seven years to write. In fact, the final chapter was incomplete when Hamilton died, and the book was finally published with a preface by his son, William Edwin Hamilton. While quaternions themselves turned out to be of no such monumental importance, their appearance as the first noncommutative algebra opened the door for much research in this field, including much of vector and matrix analysis. (As a side note, the "del" operator, named later by Gibbs, was introduced by Hamilton in his papers on quaternions.)

In dynamics, Hamilton extended his characteristic function from optics to the classical action for a system moving between two points in configuration space. A simple transformation of this function gives the quantity (the time integral of the Lagrangian) whose variation equals zero in what we now call Hamilton's principle. Jacobi later simplified the application of Hamilton's idea to mechanics, and it is the Hamilton–Jacobi equation that is most often used in such problems. Hamiltonian dynamics was rescued from what could have become historical obscurity with the advent of quantum mechanics, in which its close association with ideas in optics found fertile application in the wave mechanics of de Broglie and Schrödinger. Hamilton's later life was unhappy, and he became addicted to alcohol. He died from a severe attack of gout shortly after receiving the news that he had been elected the first foreign member of the National Academy of Sciences of the USA.

In the theoretical development of mechanics, canonical transformations play a central role. The following proposition shows that the flows of a Hamiltonian system are such transformations:

Flow of Hamiltonian vector field is canonical transformation of mechanics.

Proposition 28.7.11 *Let (M, ω, X_H) be a Hamiltonian system, and F_t the flow of X_H . Then for each t , $F_t^* \omega = \omega$, i.e., F_t is symplectic.*

Proof We have

$$\begin{aligned}
 \frac{d}{dt} F_t^* \boldsymbol{\omega} &= F_t^* L_{\mathbf{X}_H} \boldsymbol{\omega} && \text{by Eq. (28.39)} \\
 &= F_t^* (i_{\mathbf{X}_H} d\boldsymbol{\omega} + di_{\mathbf{X}_H} \boldsymbol{\omega}) && \text{by Theorem 28.5.10} \\
 &= F_t^* (0 + ddH) && \text{because } d\boldsymbol{\omega} = 0 \text{ and } i_{\mathbf{X}_H} \boldsymbol{\omega} = \boldsymbol{\omega}^\flat(\mathbf{X}) \\
 &= 0 && \text{because } d^2 = 0.
 \end{aligned}$$

Thus, $F_t^* \boldsymbol{\omega}$ is constant in t . But $F_0^* = \text{id}$. Therefore, $F_t^* \boldsymbol{\omega} = \boldsymbol{\omega}$. \square

The celebrated Liouville's theorem of mechanics, concerning the preservation of volume of the phase space, is a consequence of the proposition above:

Liouville's theorem **Corollary 28.7.12** (Liouville's theorem) F_t preserves the phase volume μ_ω .

Poisson brackets in the language of symplectic geometry **Definition 28.7.13** Let $(M, \boldsymbol{\omega})$ be a symplectic manifold. Let $f, g : M \rightarrow \mathbb{R}$ with $\mathbf{X}_f = (df)^\sharp$ and $\mathbf{X}_g = (dg)^\sharp$ their corresponding Hamiltonian vector fields. The **Poisson bracket** of f and g is the function

$$\{f, g\} \equiv \boldsymbol{\omega}(\mathbf{X}_f, \mathbf{X}_g) = i_{\mathbf{X}_g} i_{\mathbf{X}_f} \boldsymbol{\omega} = -i_{\mathbf{X}_f} i_{\mathbf{X}_g} \boldsymbol{\omega}.$$

We can immediately obtain the familiar expression for the Poisson bracket of two functions.

Proposition 28.7.14 In canonical coordinates $(q^1, \dots, q^n, p_1, \dots, p_n)$, we have

$$\{f, g\} = \sum_{i=1}^n \left(\frac{\partial f}{\partial q^i} \frac{\partial g}{\partial p_i} - \frac{\partial f}{\partial p_i} \frac{\partial g}{\partial q^i} \right).$$

In particular,

$$\{q^i, q^j\} = 0, \quad \{p_i, p_j\} = 0, \quad \{q^i, p_j\} = \delta_j^i.$$

Proof From Eq. (28.51), we have

$$\begin{aligned}
 \boldsymbol{\omega}(\mathbf{X}_f, \mathbf{X}_g) &= \boldsymbol{\omega} \left(\frac{\partial f}{\partial p_i} \frac{\partial}{\partial q^i} - \frac{\partial f}{\partial q^i} \frac{\partial}{\partial p_i}, \frac{\partial g}{\partial p_j} \frac{\partial}{\partial q^j} - \frac{\partial g}{\partial q^j} \frac{\partial}{\partial p_j} \right) \\
 &= \sum_{i,j=1}^n \left[\frac{\partial f}{\partial p_i} \frac{\partial g}{\partial p_j} \underbrace{\boldsymbol{\omega} \left(\frac{\partial}{\partial q^i}, \frac{\partial}{\partial q^j} \right)}_{=0} - \frac{\partial f}{\partial p_i} \frac{\partial g}{\partial q^j} \underbrace{\boldsymbol{\omega} \left(\frac{\partial}{\partial q^i}, \frac{\partial}{\partial p_j} \right)}_{=\delta_j^i} \right. \\
 &\quad \left. - \frac{\partial f}{\partial q^i} \frac{\partial g}{\partial p_j} \underbrace{\boldsymbol{\omega} \left(\frac{\partial}{\partial p_i}, \frac{\partial}{\partial q^j} \right)}_{=-\delta_j^i} + \frac{\partial f}{\partial q^i} \frac{\partial g}{\partial q^j} \underbrace{\boldsymbol{\omega} \left(\frac{\partial}{\partial p_i}, \frac{\partial}{\partial p_j} \right)}_{=0} \right]
 \end{aligned}$$

$$= \sum_{i=1}^n \left(\frac{\partial f}{\partial q^i} \frac{\partial g}{\partial p_i} - \frac{\partial f}{\partial p_i} \frac{\partial g}{\partial q^i} \right),$$

where we have assumed that $\omega = \sum_{k=1}^n dq^k \wedge dp_k$. The other formulas follow immediately once we substitute p_i or q^i for f or g . \square

28.8 Problems

28.1 Provide the details of the fact that a finite-dimensional vector space \mathcal{V} is a manifold of dimension $\dim \mathcal{V}$.

28.2 Choose a different curve $\gamma : \mathbb{R} \rightarrow \mathbb{R}^2$ whose tangent at $u = 0$ is still (a_x, a_y) of Example 28.2.2. For instance, you may choose

$$\gamma(u) = \left(\frac{a_x}{2}(u+1)^2, \frac{a_y}{3}(u-1)^3 \right).$$

Show that this curve gives the same relation between partials and unit vectors as obtained in that example. Can you find another curve doing the same job?

28.3 For every $\mathbf{t} \in \mathcal{T}_P(M)$ and every constant function $c \in F^\infty(P)$, show that $\mathbf{t}(c) = 0$. Hint: Use both parts of Definition 28.2.3 on the two functions $f = c$ and $g = 1$.

28.4 Find the coordinate vector field ∂_1 of Example 28.2.10.

28.5 Use the procedure of Example 28.2.10 to find a coordinate frame for S^2 corresponding to the stereographic projection charts (see Example 28.1.12).

28.6 Let (x^i) and (y^j) be coordinate systems on a subset U of a manifold M . Let X^i and Y^j be the components of a vector field with respect to the two coordinate systems. Show that $Y^j = X^i \partial y^j / \partial x^i$.

28.7 Show that if $\psi : M \rightarrow N$ is a local diffeomorphism at $P \in M$, then $\psi_{*P} : \mathcal{T}_P(M) \rightarrow \mathcal{T}_{\psi(P)}(N)$ is a vector space isomorphism.

28.8 Let \mathbf{X} be a vector field on M and $\psi : M \rightarrow N$ a differentiable map. Then for any function f on N , $[\psi_*\mathbf{X}](f)$ is a function on N . Show that

$$\mathbf{X}(f \circ \psi) = \{[\psi_*\mathbf{X}](f)\} \circ \psi.$$

28.9 Verify that the vector field $\mathbf{X} = -y\partial_x + x\partial_y$ has an integral curve through (x_0, y_0) given by

$$x = x_0 \cos t - y_0 \sin t,$$

$$y = x_0 \sin t + y_0 \cos t.$$

28.10 Show that the vector field $\mathbf{X} = x^2\partial_x + xy\partial_y$ has an integral curve through (x_0, y_0) given by

$$x(t) = \frac{x_0}{1 - x_0 t}, \quad y(t) = \frac{y_0}{1 - x_0 t}.$$

28.11 Let \mathbf{X} and \mathbf{Y} be vector fields. Show that $\mathbf{X} \circ \mathbf{Y} - \mathbf{Y} \circ \mathbf{X}$ is also a vector field, i.e., it satisfies the derivation property.

28.12 Prove the remaining parts of Proposition 28.4.13.

28.13 Suppose that x^i are coordinate functions on a subset of M and ω and \mathbf{X} are a 1-form and a vector field there. Express $\omega(\mathbf{X})$ in terms of component functions of ω and \mathbf{X} .

28.14 Show that $d \circ L_{\mathbf{X}} = L_{\mathbf{X}} \circ d$. Hint: Use the definition of the Lie derivative for p -forms and the fact that d commutes with the pullback.

28.15 Let $M = \mathbb{R}^3$ and let f be a real-valued function. Let $\omega = a_i dx^i$ be a one-form and $\eta = b_1 dx^2 \wedge dx^3 + b_2 dx^3 \wedge dx^1 + b_3 dx^1 \wedge dx^2$ be a two-form on \mathbb{R}^3 . Show that

- df gives the gradient of f ,
- $d\eta$ gives the divergence of the vector $\mathbf{B} = (b_1, b_2, b_3)$, and that
- $\nabla \times (\nabla f) = 0$ and $\nabla \cdot (\nabla \times \mathbf{A}) = 0$ are consequences of $d^2 = 0$.

28.16 Show that $i_{\mathbf{X}}$ is an antiderivation with respect to the wedge product.

28.17 Given that $\mathbf{F} = \frac{1}{2} F_{\alpha\beta} dx^\alpha \wedge dx^\beta$, show that $\mathbf{F} \wedge (*\mathbf{F}) = |\mathbf{B}|^2 - |\mathbf{E}|^2$.

28.18 Use Eq. (28.41) to show that the zeroth component of the relativistic Lorentz force law gives the rate of change of energy due to the electric field, and that the magnetic field does not change the energy.

28.19 Derive Eq. (28.44).

28.20 Write the equation

$$F_{\alpha\beta} = A_{\beta,\alpha} - A_{\alpha,\beta} = \frac{\partial A_\beta}{\partial x^\alpha} - \frac{\partial A_\alpha}{\partial x^\beta}$$

in terms of \mathbf{E} , \mathbf{B} , and vector and scalar potentials.

28.21 With $\mathbf{F} = \frac{1}{2} F_{\alpha\beta} dx^\alpha \wedge dx^\beta$ and $\mathbf{J} = J_\gamma dx^\gamma$, show that $d*\mathbf{F} = 4\pi(*\mathbf{J})$ takes the following form in components:

$$\frac{\partial F^{\alpha\beta}}{\partial x^\beta} = 4\pi J^\alpha,$$

where indices are raised and lowered by $\text{diag}(-1, -1, -1, 1)$.

28.22 Interpret Theorem 28.5.15 for $p = 1$ and $p = 2$ on \mathbb{R}^3 .

28.23 Let f be a function on \mathbb{R}^3 . Calculate $d * df$.

28.24 Show that current conservation is an automatic consequence of Maxwell's inhomogeneous equation $d * \mathbf{F} = 4\pi(*\mathbf{J})$.

Part IX

Lie Groups and Their Applications

The theory of differential equations had flourished to such a level by the 1860s that a systematic study of their solutions became possible. Sophus Lie, a Norwegian mathematician, undertook such a study using the same tool that was developed by Galois and others to study algebraic equations: group theory. The groups associated with the study of differential equations, now called Lie groups, unlike their algebraic counterparts, are uncountably infinite, and, as such, are both intricate and full of far-reaching structures. It was beyond the wildest dream of any 19th-century mathematician to imagine that a concept as abstract as Lie groups would someday find application in the study of the heart of matter. Yet, three of the four fundamental interactions are described by Lie groups, and the fourth one, gravity, is described in a language very akin to the other three.

29.1 Lie Groups and Their Algebras

Lie groups are infinite groups that have the extra property that their multiplication law is differentiable. We have seen that the natural setting for differentiation is the structure of a manifold. Thus, Lie groups must have manifold properties as well as group properties.

Definition 29.1.1 A **Lie group** G is a differentiable manifold endowed with a group structure such that the group operation $G \times G \rightarrow G$ and the map $G \rightarrow G$ given by $g \mapsto g^{-1}$ are differentiable. If the dimension of the underlying manifold is r , we say that G is an r -**parameter Lie group**. Lie groups defined

Because of the dual nature of Lie groups, most of their mapping properties combine those of groups and manifolds. For instance, a **Lie group homomorphism** is a group homomorphism that is also C^∞ , and a **Lie group isomorphism** is a group isomorphism that is also a diffeomorphism.

Example 29.1.2 ($GL(\mathcal{V})$ is a Lie group) As the paradigm of Lie groups, we consider $GL(\mathcal{V})$, the set of invertible operators on an n -dimensional real vector space \mathcal{V} , and show that it is indeed a Lie group. The set $\mathcal{L}(\mathcal{V})$ is a $GL(\mathcal{V})$ is a Lie group

vector space of dimension n^2 (Proposition 26.1.1), and therefore, by Example 28.1.7, a manifold of the same dimension. The map $\det : \mathcal{L}(\mathcal{V}) \rightarrow \mathbb{R}$ is a \mathcal{C}^∞ map because the determinant, when expressed in terms of a matrix, is a polynomial. In particular, it is continuous. Now note that

$$GL(\mathcal{V}) = \det^{-1}(\mathbb{R} - \{0\})$$

and that $\mathbb{R} - \{0\}$ is open. It follows that $GL(\mathcal{V})$ is an open submanifold of $\mathcal{L}(\mathcal{V})$. Thus, $GL(\mathcal{V})$ is an n^2 -dimensional manifold. Choosing a basis B for \mathcal{V} and representing operators (points) \mathbf{A} of $GL(\mathcal{V})$ as matrices (a_{ij}) in that basis provides a coordinate patch for $GL(\mathcal{V})$. We denote this coordinate patch by $\{x^{ij}\}$, where $x^{ij}(\mathbf{A}) = a_{ij}$.

To show that $GL(\mathcal{V})$ is a Lie group, we need to prove that if $\mathbf{A}, \mathbf{B} \in GL(\mathcal{V})$, then

$$\mathbf{AB} : GL(\mathcal{V}) \times GL(\mathcal{V}) \rightarrow GL(\mathcal{V}) \quad \text{and} \quad \mathbf{A}^{-1} : GL(\mathcal{V}) \rightarrow GL(\mathcal{V})$$

are \mathcal{C}^∞ maps of manifolds. This is done by showing that the coordinate representations of these maps are \mathcal{C}^∞ . These representations are simply the matrix representations of operators. Since \mathbf{AB} is a linear function of elements of the two matrices, it has derivatives of all orders. It follows that \mathbf{AB} is \mathcal{C}^∞ . The case of \mathbf{A}^{-1} is only slightly more complicated. We note that

$$\mathbf{A}^{-1} = \frac{P(a_{ij})}{\det \mathbf{A}}, \quad P(a_{ij}) = \text{a polynomial in } a_{ij}.$$

Thus, since $\det \mathbf{A}$ is also a polynomial in a_{ij} , the k th derivative of \mathbf{A}^{-1} is of the form $Q(a_{ij})/(\det \mathbf{A})^k$, where Q is another polynomial. The fact that $\det \mathbf{A} \neq 0$ establishes the \mathcal{C}^∞ property of \mathbf{A}^{-1} .

One can similarly show that if \mathcal{V} is a complex vector space, then $GL(\mathcal{V})$ is a manifold of dimension $2n^2$.

SL(V) is a Lie group **Example 29.1.3** (*SL(V) is a Lie group*) Recall that $SL(\mathcal{V})$ is the subgroup of $GL(\mathcal{V})$ whose elements have unit determinant. Since $\det : GL(\mathcal{V}) \rightarrow \mathbb{R}$ is \mathcal{C}^∞ , Theorem 28.3.8 and the example after it show that $SL(\mathcal{V}) = \det^{-1}(1)$ is a submanifold of $GL(\mathcal{V})$ of dimension $\dim GL(\mathcal{V}) - \dim \mathbb{R} = n^2 - 1$. Since it is already a subgroup, we conclude that $SL(\mathcal{V})$ is also a Lie group (Problem 29.5). Similarly, when \mathcal{V} is a complex vector space, one can show that $\dim SL(\mathcal{V}) = 2n^2 - 2$.

Example 29.1.4 (Other examples of Lie groups) The reader may verify the following:

- (a) Any finite-dimensional vector space is a Lie group under vector addition.
- (b) The unit circle S^1 , as a subset of nonzero multiplicative complex numbers is a Lie group under multiplication.
- (c) The product $G \times H$ of two Lie groups is itself a Lie group with the product manifold structure and the direct product group structure.
- (d) $GL(n, \mathbb{R})$, the set of invertible $n \times n$ matrices, is a Lie group under matrix multiplication.

- (e) Let $G = GL(n, \mathbb{R}) \times \mathbb{R}^n$ be the product manifold. Define the group operation by $(\mathbf{A}, \mathbf{u})(\mathbf{B}, \mathbf{v}) \equiv (\mathbf{AB}, \mathbf{Av} + \mathbf{u})$. The reader may verify that this operation indeed defines a group structure on G . In fact, G becomes a Lie group, called the **group of affine motions of \mathbb{R}^n** , for if we identify (\mathbf{A}, \mathbf{u}) with the affine motion¹ $\mathbf{x} \mapsto \mathbf{Ax} + \mathbf{u}$ of \mathbb{R}^n , then the group operation in G is composition of affine motions. We shall study in some detail the Poincaré group, a subgroup of the group of affine motions, in which the matrices are (pseudo) orthogonal.

group of affine motions of \mathbb{R}^n

In calculations, one translates all group operations to the corresponding operations of charts. This is particularly useful when the group multiplication can be defined only locally. One then speaks of an r -parameter **local Lie group**. To be precise, one considers a neighborhood U of the origin of \mathbb{R}^r and defines an associative “multiplication” $m : U \times U \rightarrow \mathbb{R}^r$ and an inversion $i : U_0 \rightarrow U$ where U_0 is a subset of U . We therefore write the multiplication as

local Lie groups

$$m(\mathbf{a}, \mathbf{b}) = \mathbf{c}, \quad \mathbf{a}, \mathbf{b}, \mathbf{c} \in \mathbb{R}^r,$$

where $\mathbf{a} = (a^1, a^2, \dots, a^r)$, etc. are coordinates of elements of G . The coordinates of the identity element of G are taken to be all zero. Thus, $m(\mathbf{a}, \mathbf{0}) = \mathbf{a}$ and $m(\mathbf{a}, i(\mathbf{a})) = \mathbf{0}$. In component forms,

$$c^k = m^k(\mathbf{a}, \mathbf{b}), \quad m^k(\mathbf{a}, i(\mathbf{a})) = 0, \quad k = 1, 2, \dots, r. \quad (29.1)$$

The fact that G is a manifold implies that all functions in Eq. (29.1) are infinitely differentiable.

Example 29.1.5 As an example of a local 1-parameter Lie group, consider the multiplication rule $m : U \times U \rightarrow \mathbb{R}$ where $U = \{x \in \mathbb{R} \mid |x| < 1\}$ and

$$m(x, y) = \frac{2xy - x - y}{xy - 1}, \quad x, y \in U.$$

The reader can check that $m(x, (y, z)) = m((x, y), z)$, so that the multiplication is associative. Moreover, $m(0, x) = m(x, 0) = x$ for all $x \in U$, and $i(x) = x/(2x - 1)$, defined for $U_0 = \{x \in \mathbb{R} \mid |x| < \frac{1}{2}\}$.

29.1.1 Group Action

As mentioned in our discussion of finite groups, the action of a group on a set is more easily conceived than abstract groups. In the case of Lie groups, the natural action is not on an arbitrary set, but on a manifold.

Definition 29.1.6 Let M be a manifold. A **local group of transformations** acting on M is a (local) Lie group G , an (open) subset U with the property $\{e\} \times M \subset U \subset G \times M$, and a map $\Psi : U \rightarrow M$ satisfying the following conditions:

local group of transformations

¹These consist of a linear transformation followed by a translation.

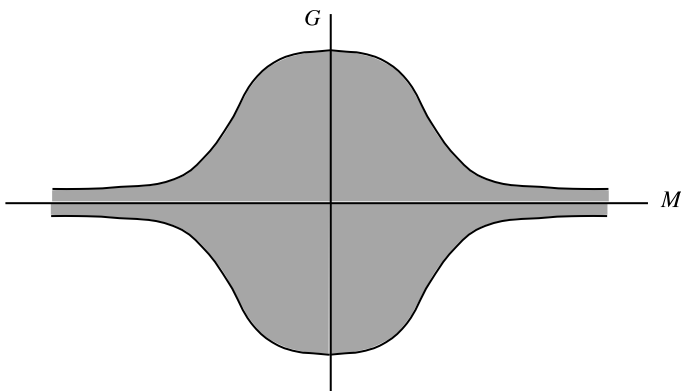

Fig. 29.1 For small regions of M , we may be able to include a large portion of G . However, if we want to include all of M , as we should, then only a small neighborhood of the identity may be available

1. If $(g, P) \in U, (h, \Psi(g, P)) \in U$, and $(hg, P) \in U$, then

$$\Psi(h, \Psi(g, P)) = \Psi(hg, P).$$
2. $\Psi(e, P) = P$ for all $P \in M$.
3. If $(g, P) \in U$, then $(g^{-1}, \Psi(g, P)) \in U$ and $\Psi(g^{-1}, \Psi(g, P)) = P$.

Normally, we shall denote $\Psi(g, P)$ by $g \cdot P$, or gP . Then the conditions of the definition above take the simple form

$$\begin{aligned}
 g \cdot (h \cdot P) &= (gh) \cdot P, \quad g, h \in G, P \in M, \\
 e \cdot P &= P \quad \text{for all } P \in M, \\
 g^{-1} \cdot (g \cdot P) &= P, \quad g \in G, P \in M,
 \end{aligned}
 \tag{29.2}$$

whenever $g \cdot P$ is defined. Note that the word “local” refers to G and not M , i.e., we may have to choose a very small neighborhood of the identity before all the elements of that neighborhood can act on *all* points of M (see Fig. 29.1).

orbit; stabilizer;
transitive, effective, and
free action

All the properties of a group action described in Chap. 23 can be applied here as well. So, one talks about the **orbit** of G as the collection of points in M obtained from one another by the action of G ; the **stabilizer** G_x of a point $x \in M$ as the collection of all group elements leaving x fixed; **transitive** action of G on M when there is only one orbit; **free** action of G on M when $G_x = \{e\}$ for all $x \in M$; and **effective** action of G on M when $g \cdot x = x$ for all $x \in M$ implies that $g = e$. The only extra condition one has to be aware of is that the group action is not defined for all elements of G , and that a sufficiently small neighborhood of the identity needs to be chosen. Since “belonging to the same orbit” is an equivalence relation on M , the set of orbits of M is denoted by M/G .

M/G is the set of orbits
in M

An important consequence of the free action of a group is the following

Theorem 29.1.7 *If G acts freely on M , then G is diffeomorphic to Gx for any $x \in M$.*

Proof We assume a left action. The proof for the right action is identical to this proof. Consider the map $\phi : Gx \rightarrow G$ given by $\phi(y) = g$ for $y = gx$. For this map to make sense, g must be determined uniquely from y . If $g_2x = y = g_1x$, then $x = g_2^{-1}g_1x$, and *because the action is free*, we conclude that $g_2^{-1}g_1 = e$ and $g_1 = g_2$, so that indeed g is determined uniquely by y . Now, we have to show that ϕ is a bijection:

Surjectivity: If $g \in G$, then clearly $gx \in Gx$ and $\phi(gx) = g$.

Injectivity: If $\phi(y_1) = \phi(y_2)$, with $y_1 = g_1x$ and $y_2 = g_2x$, then $g_1 = g_2$. □

In the old literature, the group action is described in terms of coordinates. Although for calculations this is desirable, it can be very clumsy for formal discussions, as we shall see later. Let $\mathbf{a} = (a^1, \dots, a^r)$ be a coordinate system on G and $\mathbf{x} = (x^1, \dots, x^n)$ a coordinate system on M . Then the group action $\Psi : G \times M \rightarrow M$ becomes a set of n functions described by

$$\mathbf{x}' = \Psi(\mathbf{a}, \mathbf{x}), \quad \mathbf{x}'' = \Psi(\mathbf{b}, \mathbf{x}') = \Psi(m(\mathbf{b}, \mathbf{a}), \mathbf{x}), \quad (29.3)$$

where m is the multiplication law of the Lie group written in terms of coordinates as given in Eq. (29.1). It is assumed that Ψ is infinitely differentiable.

Box 29.1.8 Equation (29.3) can be used to unravel the multiplication law for the Lie group when the latter is given in terms of transformations.

Example 29.1.9 (Examples of groups of transformation)

(a) The two-dimensional rotation group acts on the xy -plane as

$$\Phi(\theta, \mathbf{r}) = (x \cos \theta - y \sin \theta, x \sin \theta + y \cos \theta).$$

If we write $\mathbf{r}' = \Phi(\theta_1, \mathbf{r})$ and $\mathbf{r}'' = \Phi(\theta_2, \mathbf{r}')$, then a simple calculation shows that

$$\mathbf{r}'' = (x \cos(\theta_1 + \theta_2) - y \sin(\theta_1 + \theta_2), x \sin(\theta_1 + \theta_2) + y \cos(\theta_1 + \theta_2)).$$

With $\mathbf{r}'' = (m(\theta_1, \theta_2); \mathbf{r})$, we recognize the “multiplication” law as $m(\theta_1, \theta_2) = \theta_1 + \theta_2$. The orbits are circles centered at the origin.

(b) Let $M = \mathbb{R}^n$, \mathbf{a} a fixed vector in \mathbb{R}^n , and $G = \mathbb{R}$. Define $\Psi : \mathbb{R} \times \mathbb{R}^n \rightarrow \mathbb{R}^n$ by

$$\Psi(t, \mathbf{x}) = \mathbf{x} + t\mathbf{a}, \quad \mathbf{x} \in \mathbb{R}^n, \quad t \in \mathbb{R}.$$

This group action is globally defined. The orbits are straight lines parallel to \mathbf{a} . The group is the set of **translations** in the direction \mathbf{a} in \mathbb{R}^n . translations
The reader may verify that the “multiplication” law is addition of t 's.

- (c) Let $G = \mathbb{R}^+$ be the multiplicative group of nonzero positive real numbers. Fix real numbers $\alpha_1, \alpha_2, \dots, \alpha_n$, not all zero. Define the action of G on \mathbb{R}^n by

$$\Psi(\lambda, \mathbf{x}) \equiv \lambda \cdot \mathbf{x} = (\lambda^{\alpha_1} x_1, \dots, \lambda^{\alpha_n} x_n),$$

$$\lambda \in \mathbb{R}^+, \mathbf{x} = (x_1, \dots, x_n) \in \mathbb{R}^n.$$

The orbits are obtained by choosing a point in \mathbb{R}^n and applying G to it for different λ 's. The result is a curve in \mathbb{R}^n . For example, if $n = 2$, $\alpha_1 = 1$, and $\alpha_2 = 2$, we get, as the orbit containing \mathbf{x}_0 the curve

$$\lambda \cdot \mathbf{x}_0 = (\lambda x_0, \lambda^2 y_0) \Rightarrow y = \frac{y_0}{x_0^2} x^2,$$

which is a parabola going through the origin and the point (x_0, y_0) . Note that the orbit containing the origin has only one point. This group is called the group of **scale transformations**. The multiplication law is ordinary multiplication of (positive) real numbers.

scale transformations

- one-dimensional projective group (d)

Let $G = \mathbb{R}^4$ act on $M = \mathbb{R}$ by

$$\Phi(\mathbf{a}, x) \equiv \frac{a_1 x + a_2}{a_3 x + a_4}, \quad \mathbf{a} = (a_1, a_2, a_3, a_4), \quad a_1 a_4 - a_2 a_3 \neq 0.$$

The reader may verify that this is indeed the action of a group (catch where the condition $a_1 a_4 - a_2 a_3 \neq 0$ is used!), and if $x' = \Phi(\mathbf{b}, x)$ and $x'' = \Phi(\mathbf{a}, x')$, then

$$x'' = \frac{(a_1 b_1 + a_2 b_3)x + a_1 b_2 + a_2 b_4}{(a_3 b_1 + a_4 b_3)x + a_3 b_2 + a_4 b_4},$$

so that the multiplication rule is

$$m(\mathbf{a}, \mathbf{b}) = (a_1 b_1 + a_2 b_3, a_1 b_2 + a_2 b_4, a_3 b_1 + a_4 b_3, a_3 b_2 + a_4 b_4).$$

This group is called the **one-dimensional projective group**.

29.1.2 Lie Algebra of a Lie Group

The group property of a Lie group G provides a natural diffeomorphism on G that determines a substantial part of its structure.

Definition 29.1.10 Let G be a Lie group and $g \in G$. The **left translation** by g is a diffeomorphism $L_g : G \rightarrow G$ defined by

$$L_g(h) = gh \quad \forall h \in G.$$

left translation, left-invariant vector fields, left-invariant forms, and their "right" counterparts

A vector field ξ on G is called **left-invariant** if for each $g \in G$, ξ is L_g -related to itself; i.e.,²

$$L_{g*} \circ \xi = \xi \circ L_g, \quad \text{or} \quad L_{g*}(\xi(h)) = \xi(gh) \quad \forall g, h \in G.$$

²When there is no danger of confusion, we shall use $\xi(h)$ for $\xi|_h$.

The set of left-invariant vector fields on G is denoted by \mathfrak{g} . A 1-form whose pairing with a left-invariant vector field gives a constant function on G is called a **left-invariant** 1-form.

The **right translation** by g , $R_g : G \rightarrow G$, and **right-invariant** vector fields and 1-forms are defined similarly.

The reader may easily check that right and left translations commute:

$$R_g \circ L_h = L_h \circ R_g \quad \forall g, h \in G. \tag{29.4}$$

It is convenient to have a coordinate representation of L_{g^*} . The coordinate representation of L_g is simply the multiplication law $L_g(h) = m(\mathbf{g}, \mathbf{h})$, where we have used the same symbol for coordinates as for group elements. Equation (28.11) can now be used to write the coordinate representation of L_{g^*} :

$$L_{g^*} \rightarrow \begin{pmatrix} \partial m^1 / \partial h^1 & \partial m^1 / \partial h^2 & \dots & \partial m^1 / \partial h^r \\ \partial m^2 / \partial h^1 & \partial m^2 / \partial h^2 & \dots & \partial m^2 / \partial h^r \\ \vdots & \vdots & \dots & \vdots \\ \partial m^r / \partial h^1 & \partial m^r / \partial h^2 & \dots & \partial m^r / \partial h^r \end{pmatrix}, \tag{29.5}$$

where all the derivatives in the matrix are evaluated at (\mathbf{g}, \mathbf{h}) .

We have already mentioned in Chap. 28 that for a general manifold M , $\mathcal{X}(M)$ is an infinite-dimensional Lie algebra under the Lie bracket ‘‘multiplication’’. In general, $\mathcal{X}(M)$ has no finite-dimensional **subalgebra**. However, Lie groups are an exception:

Proposition 29.1.11 *Let G be a Lie group and \mathfrak{g} the set of its left-invariant vector fields. Then \mathfrak{g} is a real vector space, and the map $\phi : \mathfrak{g} \rightarrow \mathcal{T}_e(G)$, defined by $\phi(\xi) = \xi(e)$, is a linear isomorphism. Therefore, $\dim \mathfrak{g} = \dim \mathcal{T}_e(G) = \dim G$. Furthermore, \mathfrak{g} is closed under Lie brackets; i.e., \mathfrak{g} is a Lie algebra.*

Proof It is clear that \mathfrak{g} is a real vector space. If $\phi(\xi) = \phi(\eta)$ for $\xi, \eta \in \mathfrak{g}$, then

$$\xi(g) = L_{g^*}(\xi(e)) = L_{g^*}(\eta(e)) = \eta(g) \quad \forall g \in G \Rightarrow \xi = \eta.$$

This shows that ϕ is injective. To show that ϕ is surjective, suppose that $\mathbf{v} \in \mathcal{T}_e(G)$ and define the vector field ξ on G by $\xi(g) = L_{g^*}(\mathbf{v})$ for all $g \in G$. Then $\phi(\xi) = \mathbf{v}$ and $\xi \in \mathfrak{g}$, because

$$L_{g^*} \circ \xi(h) = L_{g^*} \circ L_{h^*}(\mathbf{v}) = L_{gh^*}(\mathbf{v}) = \xi(gh) \equiv \xi(L_g h) = \xi \circ L_g(h).$$

This proves the first part of the proposition. The second part follows immediately from the definition of a left-invariant vector field and Theorem 28.4.4. \square

The flow of ξ at $g \in G$ can be shown to be

$$F_t = g \exp(t\xi) = R_{\exp(t\xi)}g. \tag{29.6}$$

Indeed, let \mathbf{X}_ξ be the vector field associated with this flow. The action of this vector field on a function f is

$$\mathbf{X}_\xi|_g(f) = \left. \frac{d}{dt}(f(g \exp(t\xi))) \right|_{t=0}.$$

Therefore,

$$\begin{aligned} (L_{h*}\mathbf{X}_\xi|_g)(f) &= \mathbf{X}_\xi|_g(f \circ L_h) = \left. \frac{d}{dt}(f \circ L_h(g \exp(t\xi))) \right|_{t=0} \\ &= \left. \frac{d}{dt}(f(hg \exp(t\xi))) \right|_{t=0} = \mathbf{X}_\xi(hg)(f) = [\mathbf{X}_\xi \circ L_h(g)](f). \end{aligned}$$

Since this is true for all f and g , and $\mathbf{X}_\xi|_e = \xi(e)$, we conclude that \mathbf{X}_ξ is the unique left-invariant vector field corresponding to $\xi(e)$.

The Lie algebra of a Lie group

Definition 29.1.12 The **Lie algebra** of the Lie group G is the Lie algebra \mathfrak{g} of left-invariant vector fields on G . Sometimes we think of ξ as a vector in $\mathcal{T}_e(G)$. In that case, we denote by \mathbf{X}_ξ the left-invariant vector field whose value at the identity is ξ .

The isomorphism of \mathfrak{g} with $\mathcal{T}_e(G)$ induces a Lie bracket on $\mathcal{T}_e(G)$ and turns it into a Lie algebra. In many cases of physical interest, it is this interpretation of the Lie algebra of G that is most useful.

If two groups stand in some algebraic relation to one another, their Lie algebras will inherit such relations. More precisely, let G and H be Lie groups with Lie algebras \mathfrak{g} and \mathfrak{h} , respectively. Suppose $\phi : G \rightarrow H$ is a Lie group homomorphism. Then identifying \mathfrak{g} with $\mathcal{T}_e(G)$ and \mathfrak{h} with $\mathcal{T}_e(H)$, and using Theorem 28.4.4, we conclude that $\phi_* : \mathfrak{g} \rightarrow \mathfrak{h}$ is a Lie algebra homomorphism, i.e., it preserves the Lie brackets:

$$\phi_*[\xi, \eta] = [\phi_*\xi, \phi_*\eta] \quad \forall \xi, \eta \in \mathfrak{g}. \tag{29.7}$$

Theorem 29.1.13 *If $\phi : G \rightarrow H$ is a Lie group homomorphism, then $\phi_* : \mathfrak{g} \rightarrow \mathfrak{h}$ is a Lie algebra homomorphism.*

In particular, if ϕ is a Lie group isomorphism, then ϕ_* is a Lie algebra isomorphism.

Example 29.1.14 Let \mathcal{V} be a complex vector space with its general linear group $GL(\mathcal{V})$, a $2n^2$ -dimensional Lie group. Recall that $GL(\mathcal{V})$ is an open submanifold of $\mathcal{L}(\mathcal{V})$. By Eq. (28.4), $\mathcal{T}_e(GL(\mathcal{V})) = \mathcal{T}_e(\mathcal{L}(\mathcal{V}))$, where e is the unit operator. Now note that on the one hand, we can identify $\mathcal{T}_e(\mathcal{L}(\mathcal{V}))$ with $\mathcal{L}(\mathcal{V})$ [see the box after Eq. (28.4)]. On the other hand, $\mathcal{T}_e(GL(\mathcal{V}))$ can be identified with $\mathfrak{gl}(\mathcal{V})$, the Lie algebra of $GL(\mathcal{V})$. Therefore, $\mathfrak{gl}(\mathcal{V}) \cong \mathcal{L}(\mathcal{V})$. We use the notation $\mathbf{A}(t)$ for a curve in $GL(\mathcal{V})$ and $\dot{\mathbf{A}}$ for the vector tangent to the curve.

It is instructive to construct the coordinate representation of vector fields on $GL(\mathcal{V})$. Let $f : GL(\mathcal{V}) \rightarrow \mathbb{R}$ be a function and $\hat{\mathbf{A}}$ a vector field. Then, we have

$$\hat{\mathbf{A}}(f) = \frac{d}{dt}(f(\mathbf{A}(t))) = \frac{da_{ij}}{dt} \frac{\partial f}{\partial x^{ij}},$$

or, since f is arbitrary,

$$\hat{\mathbf{A}} = \frac{da_{ij}}{dt} \frac{\partial}{\partial x^{ij}} \equiv \dot{a}_{ij} \frac{\partial}{\partial x^{ij}} \equiv \frac{d\mathbf{A}}{dt}(t),$$

where summation over repeated indices is understood and we introduced $d\mathbf{A}/dt$ as an abbreviation for $\dot{a}_{ij}(\partial/\partial x^{ij})$. However, the one-to-one correspondence between matrices and operators makes this more than just an abbreviation. Indeed, we can interpret $d\mathbf{A}/dt$ as the derivative of \mathbf{A} and perform such differentiation whenever it is possible. The equation above states that

Box 29.1.15 To obtain the matrix elements (coordinates) of the operator $\hat{\mathbf{A}}$, one differentiates the t -dependent elements of the (matrix representation of the) operator $\mathbf{A}(t)$.

Of particular interest are the left invariant vector fields, or equivalently, the vectors belonging to $\mathcal{T}_e(GL(\mathcal{V}))$. This amounts to substituting $t = 0$ in the formulas above. Thus, if $\hat{\mathbf{A}} \in \mathcal{T}_e(GL(\mathcal{V}))$,

$$\hat{\mathbf{A}} = \dot{a}_{ij}(0) \frac{\partial}{\partial x^{ij}} \equiv \frac{d\mathbf{A}}{dt}(0). \tag{29.8}$$

For the product of two operators, we get

$$\begin{aligned} \widehat{\mathbf{A}\mathbf{B}} &= \left. \frac{d}{dt} f(\mathbf{A}(t)\mathbf{B}(t)) \right|_{t=0} = \left. \frac{d}{dt} (a_{ik}b_{kj}) \right|_{t=0} \frac{\partial}{\partial x^{ij}} \\ &= \underbrace{(\dot{a}_{ik}(0) b_{kj}(0))}_{\delta_{kj}} + \underbrace{a_{ik}(0) \dot{b}_{kj}(0)}_{\delta_{ik}} \frac{\partial}{\partial x^{ij}} \\ &= \dot{a}_{ij}(0) \frac{\partial}{\partial x^{ij}} + \dot{b}_{ij}(0) \frac{\partial}{\partial x^{ij}} = \frac{d\mathbf{A}}{dt}(0) + \frac{d\mathbf{B}}{dt}(0). \end{aligned} \tag{29.9}$$

Many of the Lie groups used in physics are subgroups of $GL(\mathcal{V})$. A characterization of the Lie algebras of these subgroups is essential for understanding the subgroups themselves and applying them to physical situations. These subgroups are typically defined in terms of maps $\phi : GL(\mathcal{V}) \rightarrow M$ for which M is a manifold and ϕ_* is surjective. To construct the Lie algebra of subgroups of $GL(\mathcal{V})$, we need to concentrate on the map ϕ_{*e} as defined on $\mathcal{T}_e(GL(\mathcal{V}))$.

An important map is $\det : GL(\mathcal{V}) \rightarrow \mathbb{C}$ for a complex vector space \mathcal{V} . We are interested in evaluating the map $\det_* : \mathcal{T}_e(GL(\mathcal{V})) \rightarrow \mathcal{T}_1(\mathbb{C})$ in which we consider $\mathbb{C} \cong \mathbb{R}^2$ to be a manifold. For an operator $\hat{\mathbf{A}} \in \mathcal{T}_e(GL(\mathcal{V})) \cong \mathfrak{gl}(\mathcal{V})$

Differential of the determinant map is the trace: $\det_* = \text{tr}$

and a complex-valued function, we have

$$\begin{aligned} \det_*(\dot{\mathbf{A}})f &\equiv \left. \frac{d}{dt} f(\det \mathbf{A}(t)) \right|_{t=0} \equiv \frac{dx}{dt} \frac{\partial f}{\partial x} + \frac{dy}{dt} \frac{\partial f}{\partial y} \\ &= \left. \frac{d}{dt} \text{Re} \det \mathbf{A}(t) \right|_{t=0} \frac{\partial f}{\partial x} + \left. \frac{d}{dt} \text{Im} \det \mathbf{A}(t) \right|_{t=0} \frac{\partial f}{\partial y} \\ &= \text{Re} \text{tr} \dot{\mathbf{A}} \frac{\partial f}{\partial x} + \text{Im} \text{tr} \dot{\mathbf{A}} \frac{\partial f}{\partial y}, \end{aligned}$$

where we used Eq. (5.34). Since f is arbitrary and $\{\partial/\partial x, \partial/\partial y\}$ can be identified with $\{1, i\}$, we have

$$\det_*(\dot{\mathbf{A}}) = \text{tr} \dot{\mathbf{A}}. \tag{29.10}$$

Example 29.1.16 (Lie algebra of $SL(\mathcal{V})$) The special linear group $SL(\mathcal{V})$ is characterized by the fact that all its elements have unit determinant.

Box 29.1.17 *The Lie algebra $\mathfrak{sl}(\mathcal{V})$ of the special linear group is the set of all traceless operators.*

This is because if we use (29.10) and (28.12) and the fact that $SL(\mathcal{V}) = \det^{-1}(1)$, we can conclude that $\det_*(\dot{\mathbf{A}}) = \text{tr} \dot{\mathbf{A}} = 0$ for all $\dot{\mathbf{A}} \in \mathfrak{sl}(\mathcal{V})$.

Example 29.1.18 (Lie algebras of unitary and related groups) Let us first show that the set of unitary operators on \mathcal{V} , denoted by $U(\mathcal{V})$, is a Lie subgroup of $GL(\mathcal{V})$, called the **unitary group** of \mathcal{V} . Consider the map $\psi : GL(\mathcal{V}) \rightarrow \mathbb{H}$, where \mathbb{H} is the set of hermitian operators considered as a vector space (therefore, a manifold) *over the reals*, defined by $\psi(\mathbf{A}) = \mathbf{A}\mathbf{A}^\dagger$. Using Eq. (29.9), the reader may verify that ψ_* is surjective and

$$\psi_*(\dot{\mathbf{A}}) = \dot{\mathbf{A}} + \dot{\mathbf{A}}^\dagger. \tag{29.11}$$

It follows from Theorem 28.3.8 that $U(\mathcal{V}) \equiv \psi^{-1}(\mathbf{1})$ is a subgroup of $GL(\mathcal{V})$. Using Eq. (28.12), we conclude that $\psi_*(\dot{\mathbf{A}}) = \dot{\mathbf{A}} + \dot{\mathbf{A}}^\dagger = 0$ for all $\dot{\mathbf{A}} \in \mathfrak{u}(\mathcal{V})$, i.e.,

Box 29.1.19 *The Lie algebra $\mathfrak{u}(\mathcal{V})$ of the unitary group is the set of all anti-hermitian operators.*

When the vector space is \mathbb{C}^n , we write $U(n)$ instead of $U(\mathbb{C}^n)$. By counting the number of independent *real* parameters of a matrix representing a hermitian operator, we can conclude that $\dim \mathbb{H} = n^2$. It follows from Theorem 28.3.8 that $\dim U(\mathcal{V}) = n^2$.

The intersection of $SL(\mathcal{V})$ and $U(\mathcal{V})$, denoted by $SU(\mathcal{V})$, is called the **special unitary group**. When the vector space is \mathbb{C}^n , we write $SU(n)$ instead of $SU(\mathbb{C}^n)$. The previous two results yields

Box 29.1.20 *The Lie algebra $\mathfrak{su}(\mathcal{V})$ consists of anti-hermitian traceless operators. If $\dim \mathcal{V} = n$, then $\dim \mathfrak{su}(\mathcal{V}) = n^2 - 1$. We write $\mathfrak{su}(n)$ for $\mathfrak{su}(\mathcal{V})$ if $\mathcal{V} = \mathbb{C}^n$.*

The reader is asked to check that $\dim \mathfrak{su}(\mathcal{V}) = n^2 - 1$.

If we restrict ourselves to real vector spaces, then unitary and special unitary groups become the **orthogonal group** $O(\mathcal{V})$ and **special orthogonal group** $SO(\mathcal{V})$, respectively. Their algebras consist of antisymmetric and traceless antisymmetric operators, respectively. When $\mathcal{V} = \mathbb{R}^n$, we use the notation $O(n)$ and $SO(n)$. orthogonal and special orthogonal groups

Let \mathbf{X} be a vector field on G . We know from our discussion of flows that \mathbf{X} has a flow $F_t \equiv \exp(t\mathbf{X})$ at every point g of G with $-\epsilon < t < \epsilon$. Now, since $F_t(g) \neq g$ is in G , it follows from the group property of G that $(F_t)^n(g) = F_{nt}(g) \in G$ for all n . This shows that the flow of every vector field on a Lie group is defined for all $t \in \mathbb{R}$, i.e., all vector fields on a Lie group are complete. Now consider \mathfrak{g} as a vector space *and manifold* and define a map $\exp : \mathfrak{g} \rightarrow G$ that is simply the flow evaluated at $t = 1$. It can be shown that the following result holds ([Warn 83, pp. 103–104]):

Theorem 29.1.21 $\exp : \mathfrak{g} \rightarrow G$, called the **exponential map**, is a diffeomorphism of a neighborhood of the origin of \mathfrak{g} with a neighborhood of the identity element of G . exponential map of a Lie algebra

This theorem states that in a neighborhood of the identity element, a Lie group, as a manifold, “looks like” its tangent space there. In particular,

Box 29.1.22 *Two Lie groups that have identical Lie algebras are locally diffeomorphic.*

Example 29.1.23 (Why \exp is called the exponential map) Let \mathcal{V} be a finite-dimensional vector space and $\mathbf{A} \in \mathfrak{gl}(\mathcal{V})$. Define, as in Chap. 4,

$$e^{t\mathbf{A}} = \sum_{k=0}^{\infty} \frac{t^k \mathbf{A}^k}{k!} = \mathbf{1} + t\mathbf{A} + \dots$$

and note that

$$\frac{d}{dt} e^{t\mathbf{A}} = \mathbf{A} e^{t\mathbf{A}} \Rightarrow \left. \frac{d}{dt} e^{t\mathbf{A}} \right|_{t=0} = \mathbf{A}.$$

Furthermore,

$$e^{t\mathbf{A}} e^{s\mathbf{A}} = \sum_{k=0}^{\infty} \frac{t^k \mathbf{A}^k}{k!} \sum_{n=0}^{\infty} \frac{s^n \mathbf{A}^n}{n!} = \sum_{k=0}^{\infty} \sum_{n=0}^{\infty} \frac{t^k s^n}{k!n!} \mathbf{A}^{k+n}$$

$$= \sum_{m=0}^{\infty} \underbrace{\left(\sum_{n=0}^m \frac{t^{m-n} s^n}{(m-n)!n!} \right)}_{=(t+s)^m/m!} \mathbf{A}^m = e^{(t+s)\mathbf{A}}.$$

It follows that $e^{t\mathbf{A}}$ has all the properties expected of the flow of the vector field \mathbf{A} .

The exponential map has some important properties that we shall have occasion to use later. The first of these properties is the content of the following proposition, whose proof is left as an exercise for the reader.

Proposition 29.1.24 *Let $\phi : H \rightarrow G$ be a Lie group homomorphism. Then, for all $\eta \in \mathfrak{h}$, we have $\phi(\exp_H \eta) = \exp_G(\phi_*\eta)$.*

For every $g \in G$, let $I_g \equiv R_g^{-1} \circ L_g$. The reader may readily verify that I_g , which takes $x \in G$ to $gxg^{-1} \in G$, is an isomorphism of G , i.e., inner automorphism of a Lie group $I_g(xy) = I_g(x)I_g(y)$ and I_g is bijective. It is called the **inner automorphism** associated with g .

adjoint map of a Lie algebra **Definition 29.1.25** The Lie algebra isomorphism $I_{g*} = R_{g*}^{-1} \circ L_{g*} : \mathfrak{g} \rightarrow \mathfrak{g}$ is denoted by Ad_g and is called the **adjoint map** associated with g .

Since \mathfrak{g} is a vector space, the adjoint map can be used to construct a representation of G .

Definition 29.1.26 The **adjoint representation** of a Lie group G is $Ad : G \rightarrow GL(\mathfrak{g})$ given by $Ad(g) = Ad_g \equiv I_{g*}$.

Using Proposition 29.1.24, we have the following corollary.

Corollary 29.1.27 $\exp(Ad_g \xi) = I_g \exp \xi = g \exp \xi g^{-1}$ for all $\xi \in \mathfrak{g}$ and $g \in G$.

Let $\{\xi_i\}$ be a basis for the (finite-dimensional) Lie algebra of the Lie group G . The Lie bracket of two basis vectors, being itself a left-invariant vector field, can be written as a linear combination of $\{\xi_i\}$:

$$[\xi_i, \xi_j] = \sum_{k=1}^n c_{ij}^k \xi_k.$$

On a general manifold, c_{ij}^k will depend on the point at which the fields are being evaluated. However, on Lie groups, they are independent of the point, as the following manipulation shows:

$$\begin{aligned} [\xi_i(g), \xi_j(g)] &= [L_{g*}\xi_i(e), L_{g*}\xi_j(e)] = L_{g*}[\xi_i(e), \xi_j(e)] \\ &= L_{g*} \sum_{k=1}^n c_{ij}^k(e) \xi_k(e) = \sum_{k=1}^n c_{ij}^k(e) L_{g*}\xi_k(e) \end{aligned}$$

$$= \sum_{k=1}^n c_{ij}^k(e) \xi_k(g).$$

Therefore, the value of c_{ij}^k at any point $g \in G$ is the same as its value at the identity, i.e., c_{ij}^k is a constant. This statement is called **Lie's second theorem**.

Definition 29.1.28 Let $\{\xi_i\}_{i=1}^n$ be a basis for the Lie algebra \mathfrak{g} of the Lie group G . Then

$$[\xi_i(g), \xi_j(g)] = \sum_{k=1}^n c_{ij}^k \xi_k(g), \tag{29.12}$$

structure constants of a Lie algebra

where c_{ij}^k , which are independent of g , are called the **structure constants** of G .

The structure constants satisfy certain relations that are immediate consequences of the commutation relations. The antisymmetry of the Lie bracket and the Jacobi identity lead directly to

Lie's third theorem

$$\begin{aligned} c_{\rho\sigma}^\kappa &= -c_{\sigma\rho}^\kappa, \\ c_{\rho\sigma}^\kappa c_{\kappa\mu}^\nu + c_{\sigma\mu}^\kappa c_{\kappa\rho}^\nu + c_{\mu\rho}^\kappa c_{\kappa\sigma}^\nu &= 0. \end{aligned} \tag{29.13}$$

The fact that $\{c_{\sigma\rho}^\kappa\}$ obey Eq. (29.13) is the content of **Lie's third theorem**.

29.1.3 Invariant Forms

If $\omega|_e$ is a 1-form on $\mathcal{T}_e(G)$, then $\omega \in \Lambda^1(G)$, given by $\omega|_g \equiv L_{g^{-1}}^* \omega|_e$, is a left-invariant 1-form:

$$\begin{aligned} \omega|_g(\mathbf{X}|_g) &= L_{g^{-1}}^* \omega|_e(\mathbf{X}|_g) = \omega|_e(L_{g^{-1}*} \mathbf{X}|_g) \\ &= \omega|_e(\mathbf{X}|_{g^{-1}g}) = \omega|_e(\mathbf{X}|_e) \end{aligned} \tag{29.14}$$

independent of g . A differential form ω on G is called left-invariant if $L_g^*(\omega) = \omega$ for every $g \in G$. If ω is a left-invariant p -form and $\{\xi_i\}_{i=1}^p$ a set of left-invariant vector fields, then, as in (29.14), the function $\omega(\xi_1, \dots, \xi_p)$ is constant on G . The exterior derivative of a left-invariant p -form satisfies

$$\begin{aligned} d\omega(\xi_1, \dots, \xi_{p+1}) &= \sum_{1 \leq i < j \leq p+1} (-1)^{i+j} \omega([\xi_i, \xi_j], \xi_1, \dots, \hat{\xi}_i, \dots, \hat{\xi}_j, \dots, \xi_{p+1}) \end{aligned}$$

where we used Theorem 28.5.11 and the fact that vector fields give zero when acting on a constant function. For a left-invariant 1-form, this yields

$$d\omega(\xi, \eta) = -\omega([\xi, \eta]). \tag{29.15}$$

Definition 29.1.29 The **canonical 1-form** θ on a Lie group G is the left-invariant \mathfrak{g} -valued 1-form uniquely determined by $\theta(\xi) = \xi$ for all $\xi \in \mathfrak{g}$.

Let $\{\xi_i\}_{i=1}^n$ be a basis for \mathfrak{g} . Then, $\theta = \sum_{i=1}^n \theta^i \xi_i$, where θ^i are real-valued 1-forms. Now the definition of θ gives

$$\xi_j = \theta(\xi_j) = \sum_{i=1}^n \theta^i(\xi_j) \xi_i.$$

This implies that $\theta^i(\xi_j) = \delta_j^i$, i.e., that $\{\theta^i\}_{i=1}^n$ is the dual basis of $\{\xi_i\}_{i=1}^n$.

We now want to express the exterior derivative of θ^i in the basis $\{\theta^i\}_{i=1}^n$. Since it is a 2-form, $d\theta^i = \alpha_{lm}^i \theta^l \wedge \theta^m$, for some $\alpha_{lm}^i \in \mathbb{R}$ to be determined. Since it is invariant, it must satisfy Eq. (29.15). So, we must have

$$\alpha_{lm}^i \theta^l \wedge \theta^m(\xi_j, \xi_k) = -\theta^i[\xi_j, \xi_k].$$

For the right-hand side, using Eq. (29.12), we have

$$\theta^i[\xi_j, \xi_k] = c_{jk}^l \theta^i(\xi_l) = c_{jk}^l \delta_l^i = c_{jk}^i.$$

For the left-hand side, we obtain

$$\begin{aligned} \alpha_{lm}^i \theta^l \wedge \theta^m(\xi_j, \xi_k) &= \alpha_{lm}^i [\theta^l(\xi_j) \theta^m(\xi_k) - \theta^l(\xi_k) \theta^m(\xi_j)] \\ &= \alpha_{lm}^i [\delta_j^l \delta_k^m - \delta_k^l \delta_j^m] = 2\alpha_{jk}^i \end{aligned}$$

because α_{jk}^i is antisymmetric in its lower indices. The last two equations imply that $\alpha_{jk}^i = \frac{1}{2} c_{jk}^i$. We thus arrive at the **Maurer-Cartan equation**:

$$d\theta^i = -\frac{1}{2} c_{jk}^i \theta^j \wedge \theta^k. \quad (29.16)$$

Multiplying both sides by ξ_i and summing over i , the left-hand side becomes $d\theta$. The right-hand side gives

$$-\frac{1}{2} c_{jk}^i \theta^j \wedge \theta^k \xi_i = -\frac{1}{2} \theta^j \wedge \theta^k [\xi_j, \xi_k] \equiv -\frac{1}{2} [\theta, \theta]$$

where the last expression is defined by the middle expression. Thus the Maurer-Cartan equation can also be written as

$$d\theta = -\frac{1}{2} [\theta, \theta]. \quad (29.17)$$

29.1.4 Infinitesimal Action

The action $\Phi : G \times M \rightarrow M$ of a Lie group on a manifold M induces a homomorphism of its algebra with $\mathcal{X}(M)$. If $\xi \in \mathfrak{g}$, then $\exp(t\xi) \in G$ can act on M at a point P to produce a curve $\gamma(t) = \exp(t\xi) \cdot P$ going through P . The tangent to this curve at P is defined to be the image of this homomorphism.

Definition 29.1.30 Let $\Phi : G \times M \rightarrow M$ be an action. If $\xi \in \mathfrak{g}$, then $\Phi(\exp t\xi, P)$ is a flow on M . The corresponding vector field on M given by

$$\xi_M|_P \equiv \xi_M(P) \equiv \left. \frac{d}{dt} \Phi(\exp t\xi, P) \right|_{t=0}$$

is called the **infinitesimal generator** of the action induced by ξ .

In particular,

Box 29.1.31 *If M happens to be a vector space, and the action a representation as given in Box 24.1.3, then the infinitesimal generators constitute a representation of the Lie algebra of the group.*

Infinitesimal generators of representations of G form a representation of \mathfrak{g} .

Example 29.1.32 One can think of left translation on a Lie group G as an action of G on itself. Let $\Phi : G \times G \rightarrow G$ be given by $\Phi(g, h) = L_g(h)$. Then Definition 29.1.30 gives

$$\begin{aligned} \xi_G(g) &= \left. \frac{d}{dt} \Phi(\exp t\xi, g) \right|_{t=0} = \left. \frac{d}{dt} \exp t\xi g \right|_{t=0} = \left. \frac{d}{dt} R_g(\exp t\xi) \right|_{t=0} \\ &= R_{g*} \xi \end{aligned}$$

by the first equation in (28.24). It follows that ξ_G is *right-invariant*. Indeed,

$$\begin{aligned} \xi_G \circ R_h(g) &= \xi_G(gh) = (R_{gh})_* \xi = (R_h \circ R_g)_* \xi = R_{h*} \circ R_{g*} \xi \\ &= R_{h*} \circ \xi_G(g). \end{aligned}$$

Since this holds for all $g \in G$, it follows that $\xi_G \circ R_h = R_{h*} \circ \xi_G$, demonstrating that ξ_G is right-invariant.

The adjoint map of Definition 29.1.25 induces a natural action on the Lie algebra \mathfrak{g} with some important properties that we now explore. Define the **adjoint action** $\Phi : G \times \mathfrak{g} \rightarrow \mathfrak{g}$ of G on $\mathfrak{g} \cong \mathcal{T}_e(G)$ by $\Phi(g, \xi) = Ad_g(\xi)$.

Theorem 29.1.33 *The infinitesimal generator $\xi_{\mathfrak{g}}$ of the adjoint action is ad_{ξ} , where $\text{ad}_{\xi}(\eta) \equiv [\xi, \eta]$.*

Proof In fact,

$$\begin{aligned} \xi_{\mathfrak{g}}(\eta) &= \left. \frac{d}{dt} \Phi(\exp t\xi, \eta) \right|_{t=0} = \left. \frac{d}{dt} Ad_{\exp t\xi}(\eta) \right|_{t=0} \\ &= \left. \frac{d}{dt} R_{\exp t\xi}^{-1} \circ L_{\exp t\xi}(\eta) \right|_{t=0} = \left. \frac{d}{dt} F_{t*}^{-1} \eta(\exp t\xi) \right|_{t=0} \\ &= L_{\xi}(\eta) = [\xi, \eta] \equiv \text{ad}_{\xi}(\eta), \end{aligned} \tag{29.18}$$

where we used Eq. (29.6) as well as the definition of Lie derivative, Eq. (28.31). \square

If $\Phi : G \times M \rightarrow M$ is an action, then $\Phi_g : M \rightarrow M$, defined by $\Phi_g(P) = \Phi(g, P)$, is a diffeomorphism of M . Consequently, $\Phi_{g*} : \mathcal{T}_P(M) \rightarrow \mathcal{T}_{g \cdot P}(M)$ is an isomorphism for every $P \in M$ whose inverse is $\Phi_{g*}^{-1} = \Phi_{g^{-1}*}$.

Proposition 29.1.34 *Let $\Phi : G \times M \rightarrow M$ be an action. Then for every $g \in G$ and $\xi, \eta \in \mathfrak{g}$, we have*

$$(Ad_g \xi)_M = \Phi_{g*}^{-1} \xi_M \quad \text{and} \quad [\xi_M, \eta_M] = -[\xi, \eta]_M.$$

Proof Let P be any point in M . Then,

$$\begin{aligned} (Ad_g \xi)_M(P) &= \left. \frac{d}{dt} \Phi(\exp t Ad_g \xi, P) \right|_{t=0} && \text{(by Definition 29.1.30)} \\ &= \left. \frac{d}{dt} \Phi(g(\exp t \xi)g^{-1}, P) \right|_{t=0} && \text{(by Corollary 29.1.27)} \\ &= \left. \frac{d}{dt} \Phi(g(\exp t \xi), \Phi_{g^{-1}}(P)) \right|_{t=0} && \text{(by definition of action)} \\ &= \left. \frac{d}{dt} \Phi_g \circ \Phi(\exp t \xi, \Phi_{g^{-1}}(P)) \right|_{t=0} && \text{(by definition of } \Phi_g) \\ &= \Phi_{g*}|_{\Phi_{g^{-1}}(P)} \left. \frac{d}{dt} \Phi(\exp t \xi, \Phi_{g^{-1}}(P)) \right|_{t=0} && \text{[by (28.24)]} \\ &= \Phi_{g*}|_{\Phi_{g^{-1}}(P)} \xi_M(\Phi_{g^{-1}}(P)) = (\Phi_{g*} \xi_M)(P). && \text{[by (28.28)]} \end{aligned}$$

The second part of the proposition follows by replacing g with $\exp t \eta$, so that

$$(Ad_{\exp t \eta} \xi)_M = \Phi_{\exp t \eta*} \xi_M = \Phi_{\exp t(-\eta)*}^{-1} \xi_M.$$

Differentiate both sides with respect to t and note that the LHS gives $[\eta, \xi]_M$. The derivative of the RHS is the Lie derivative of ξ_M with respect to $-\eta_M$, which is $-[\eta_M, \xi_M]$. \square

Proposition 29.1.34 calculated the infinitesimal action of I_g for a fixed $g \in G$. This can be considered as a kind of partial derivative. Proposition 28.3.7 shows us how to find the total derivative for a general action Φ . For $\xi \in \mathcal{T}_g(G)$ and $\mathbf{X} \in \mathcal{T}_P(M)$, Proposition 28.3.7 yields

$$\Phi_*(\xi, \mathbf{X}) = \Phi_{g*}(\mathbf{X}) + \Phi_{P*}(\xi) \equiv g \cdot \mathbf{X} + \xi \cdot P \quad (29.19)$$

where the last identity defines the symbols on its left. Note that if $\xi_0 = \xi(e)$, then $\xi = L_{g*} \xi_0$ in the equation above. We will have some occasions to use Eq. (29.19) later.

As mentioned earlier, a Lie group action is usually described in terms of the parameters of the group, which are simply coordinate functions on the group G , as well as coordinate functions on the manifold M . The infinitesimal generators, being vector fields on M , will then be expressed as a linear combination of coordinate frames.

In the older literature, no mention of the manifold structure is made. A Lie group is *defined* in terms of multiplication functions and other functions that represent the action of the group on the manifold. Thus, an r -parameter Lie group G is a collection of two sets of functions, $m^\rho : \mathbb{R}^r \times \mathbb{R}^r \rightarrow \mathbb{R}$, $\rho = 1, 2, \dots, r$, representing the group multiplication, and $\phi^i : \mathbb{R}^r \times \mathbb{R}^n \rightarrow \mathbb{R}$, $i = 1, 2, \dots, n$, representing the action of G on the n -dimensional manifold M . We sketch the procedure below, leaving most of the calculations as exercises for the reader. As we develop the theory, the reader is urged to compare this “coordinate-dependent” procedure with the “geometric” procedure—which does not use coordinates—described so far.

comparison of coordinate manipulations with geometric (coordinate-free) analysis

The action of the group is described by the coordinate transformations³

$$\begin{aligned} x'_i &= \phi_i(a_1, \dots, a_r; x_1, \dots, x_n), \quad i = 1, \dots, n, \\ x_i &= \phi_i(0, \dots, 0; x_1, \dots, x_n), \end{aligned} \tag{29.20}$$

as well as the group multiplication properties

$$\begin{aligned} c_\rho &= m_\rho(a_1, \dots, a_r; b_1, \dots, b_r), \quad \rho = 1, \dots, r, \\ a_\rho &= m_\rho(0, \dots, 0; a_1, \dots, a_r) = m_\rho(a_1, \dots, a_r; 0, \dots, 0), \\ m_\rho(\mathbf{a}; m(\mathbf{b}; \mathbf{c})) &= m_\rho(m(\mathbf{a}; \mathbf{b}); \mathbf{c}). \end{aligned} \tag{29.21}$$

Equation (29.20) is to be interpreted as a rule that takes the second set of arguments and transforms them via the first set into the LHS. Now suppose that we translate from x'_i to a neighboring point $x'_i + dx'_i$ via a set of group parameters $\{\delta a_\rho\}_{\rho=1}^r$. We can also get to $x'_i + dx'_i$ from x_i via a new set of parameters,⁴ which have to be slightly different from $\{a_\rho\}_{\rho=1}^r$, say $\{a_\rho + da_\rho\}_{\rho=1}^r$. We then have

$$\begin{aligned} x'_i + dx'_i &= \phi_i(\delta a_1, \dots, \delta a_r; x'_1, \dots, x'_n), \\ x'_i + dx'_i &= \phi_i(a_1 + da_1, \dots, a_r + da_r; x_1, \dots, x_n), \\ a_\rho + da_\rho &= m_\rho(\delta a_1, \dots, \delta a_r; a_1, \dots, a_r), \end{aligned} \tag{29.22}$$

and, with summation over repeated indices understood,

$$\begin{aligned} dx'_i &= \left. \frac{\partial \phi_i(\mathbf{a}; \mathbf{x}')}{\partial a_\kappa} \right|_{\mathbf{a}=0} \delta a_\kappa \equiv u_{i\kappa}(\mathbf{x}') \delta a_\kappa, \\ da_\lambda &= \left. \frac{\partial m_\lambda(\mathbf{b}; \mathbf{a})}{\partial b_\kappa} \right|_{\mathbf{b}=0} \delta a_\kappa \equiv \theta_{\lambda\kappa}(\mathbf{a}) \delta a_\kappa. \end{aligned} \tag{29.23}$$

³We use subscripts for coordinate functions here for typographical convenience.

⁴Here we are assuming that the action of the group is **transitive**, i.e., that every point of the manifold can be connected to any other point via a transformation.

Inverting the second equation and substituting the resulting δa 's in the first equation yields

$$dx'_i = u_{i\kappa}(\mathbf{x}')\theta_{\kappa\lambda}^{-1}(\mathbf{a})da_\lambda, \quad \text{or} \quad dx_i = u_{i\kappa}(\mathbf{x})\theta_{\kappa\lambda}^{-1}(\mathbf{a})da_\lambda,$$

where in the last equation, we changed the free coordinate variable on both sides. It then follows that

$$\frac{\partial x_i}{\partial a_\lambda} = \sum_{\kappa=1}^r u_{i\kappa}(\mathbf{x})\theta_{\kappa\lambda}^{-1}(\mathbf{a}). \tag{29.24}$$

Lie's first theorem Equation (29.24) and establishing that $u_{i\kappa}$ is \mathcal{C}^∞ is the content of **Lie's first theorem**.

The change of an arbitrary function $f(\mathbf{x})$ due to an infinitesimal transformation is

$$df = \frac{\partial f}{\partial x_i} dx_i = \frac{\partial f}{\partial x_i} u_{i\kappa}(\mathbf{x}) \delta a_\kappa = \delta a_\kappa \left(u_{i\kappa}(\mathbf{x}) \frac{\partial}{\partial x_i} \right) f.$$

This suggests calling

$$\mathbf{X}_\kappa = \sum_{i=1}^n u_{i\kappa}(\mathbf{x}) \frac{\partial}{\partial x_i} \tag{29.25}$$

infinitesimal generators as vector fields on M the **infinitesimal generators** of the Lie group. The commutator of two of these generators is

$$[\mathbf{X}_\rho, \mathbf{X}_\sigma] = \left[u_{i\rho} \frac{\partial u_{j\sigma}}{\partial x_i} - u_{i\sigma} \frac{\partial u_{j\rho}}{\partial x_i} \right] \frac{\partial}{\partial x_j}. \tag{29.26}$$

This commutator does not appear to be similar to the one in Definition 29.1.28, which is necessary if the generators are to form a Lie algebra. However, through a long and tortuous manipulation, outlined in Problem 29.9, one can show that

$$[\mathbf{X}_\rho, \mathbf{X}_\sigma] = c_{\rho\sigma}^\kappa \mathbf{X}_\kappa \tag{29.27}$$

where $c_{\rho\sigma}^\kappa$ are constants.

One can also obtain this same result by the much simpler method of applying Proposition 29.1.34 to both sides of Eq. (29.12):

$$[(\xi_i)_M, (\xi_j)_M] = -[\xi, \eta]_M = - \left(\sum_{k=1}^n c_{ij}^k \xi_k \right)_M = - \sum_{k=1}^n c_{ij}^k (\xi_k)_M.$$

This equation is equivalent to (29.27) if we identify the \mathbf{X}_ρ 's with the $(\xi_i)_M$'s and ignore the irrelevant minus sign.

The reader has hopefully been able to appreciate the power and elegance of the geometric approach to Lie groups and Lie algebras. The above illustration (Problem 29.9) brings out the tedium and the error-prone procedure of obtaining group-theoretic results through coordinate manipulations, a procedure used in the old literature including the work of Sophus Lie himself. Although such calculations are inevitable in practice, where most Lie

groups are given in terms of parameters, they are not suitable for obtaining formal results.

Example 29.1.35 The two-dimensional rotation group $SO(2)$ is a 1-parameter Lie group defined by

$$\begin{aligned}x'_1 &\equiv \phi_1(x_1, x_2; \theta) = x_1 \cos \theta - x_2 \sin \theta, \\x'_2 &\equiv \phi_2(x_1, x_2; \theta) = x_1 \sin \theta + x_2 \cos \theta.\end{aligned}$$

Using Eq. (29.25), we find the (only) generator of this group:

$$\mathbf{X} = u_i \frac{\partial}{\partial x_i} \quad \text{where} \quad u_i = \left. \frac{\partial \phi_i}{\partial \theta} \right|_{\theta=0}.$$

Explicitly, we have

$$\begin{aligned}u_1 &= \left. \frac{\partial \phi_1}{\partial \theta} \right|_{\theta=0} = (-x_1 \sin \theta - x_2 \cos \theta)|_{\theta=0} = -x_2, \\u_2 &= \left. \frac{\partial \phi_2}{\partial \theta} \right|_{\theta=0} = (x_1 \cos \theta - x_2 \sin \theta)|_{\theta=0} = x_1,\end{aligned}$$

and

$$\mathbf{X} = u_1 \frac{\partial}{\partial x_1} + u_2 \frac{\partial}{\partial x_2} = -x_2 \frac{\partial}{\partial x_1} + x_1 \frac{\partial}{\partial x_2}.$$

The reader recognizes this, within a factor of i , as the z -component of the angular momentum operator in quantum mechanics. In fact, with $\mathbf{p}_n = -i\partial/\partial x_n$, we have

$$\mathbf{X} = i(x_1 \mathbf{p}_2 - x_2 \mathbf{p}_1) = i\mathbf{L}_3 \quad \text{or} \quad \mathbf{L}_3 = -i\mathbf{X}$$

where \mathbf{L}_3 is the third component of angular momentum operator $\mathbf{r} \times \mathbf{p}$. Therefore,

Box 29.1.36 *Angular momentum operators are the infinitesimal generators of rotation.*

Inclusion of the other two rotations about the x -axis and the y -axis completes the set of infinitesimal generators of the rotation group in three dimensions. Let us obtain the commutation relation between these components. First we note that the x - and y -components can also be calculated as

$$\mathbf{X}_x = y \frac{\partial}{\partial z} - z \frac{\partial}{\partial y}, \quad \mathbf{X}_y = z \frac{\partial}{\partial x} - x \frac{\partial}{\partial z},$$

and all the three results can be summarized as $\mathbf{X}_j = \epsilon_{jmn} x_m \partial/\partial x_n$, with summation over the repeated indices understood. In terms of momentum, this becomes $\mathbf{X}_j = i\epsilon_{jmn} x_m \mathbf{p}_n$ and $\mathbf{L}_j = -i\mathbf{X}_j = \epsilon_{jmn} x_m \mathbf{p}_n$. The commutation relation among the components of angular momentum can now be

calculated

$$\begin{aligned}
 [\mathbf{L}_j, \mathbf{L}_k] &= \epsilon_{jmn} \epsilon_{krs} [x_m \mathbf{p}_n, x_r \mathbf{p}_s] \\
 &= \epsilon_{jmn} \epsilon_{krs} (x_m [\mathbf{p}_n, x_r] \mathbf{p}_s + x_r [x_m, \mathbf{p}_s] \mathbf{p}_n) \\
 &= \epsilon_{jmn} \epsilon_{krs} (-i \delta_{rn} x_m \mathbf{p}_s + i \delta_{sm} x_r \mathbf{p}_n) \\
 &= -i \epsilon_{jmn} \epsilon_{kns} x_m \mathbf{p}_s + i \epsilon_{jmn} \epsilon_{krm} x_r \mathbf{p}_n.
 \end{aligned}$$

Using

$$\epsilon_{jmn} \epsilon_{ksn} = \delta_{jk} \delta_{ms} - \delta_{js} \delta_{km} \quad \text{and} \quad x_j \mathbf{p}_k - x_k \mathbf{p}_j = \epsilon_{jkm} \mathbf{L}_m,$$

we obtain

$$[\mathbf{L}_j, \mathbf{L}_k] = i \epsilon_{jkm} \mathbf{L}_m$$

which is the desired result.

We obtained the generators of rotation by obtaining each component separately from equations connecting two x 's to two x s involving only one angle. We could have used three equations connecting the three x 's directly to the three x s. Such an equation writes each x ' in terms of the three x s and trigonometric functions of three angles, the Euler angles. The matrix connecting the two sets of coordinates is given in Example 5.2.7. Problem 29.10, which the reader is asked to solve as a very illuminating exercise, calculates the three components of angular momentum directly.

The action of a Lie group on M can be reconstructed from its infinitesimal action. The flow of \mathbf{X}_κ is the solution of the DE

$$\frac{dx'_i}{dt} = u_{i\kappa}(\mathbf{x}'), \quad x'_i(0) = x_i. \quad (29.28)$$

Once the solution is obtained, one can replace t with a_κ for each κ . In some applications, $u_{i\kappa}(\mathbf{x})$ will be given implicitly in terms of certain parameters of integration of some DEs [unrelated to (29.28)]. The solution of these DEs are typically generators of coordinate transformations that can be written linearly in terms of the parameters. To be more precise, suppose that after solving some DEs, we obtain

$$X_i = \sum_{\kappa=1}^r c_{i\kappa} f_\kappa^{(i)}(x_1, \dots, x_n), \quad (29.29)$$

where $\{c_{i\kappa}\}$ are the parameters of integration, and X_i are components of the vector field that generates the coordinate transformation. This means that for small parameters, one can write

$$x'_i = x_i + \sum_{\kappa=1}^r c_{i\kappa} f_\kappa^{(i)}(x_1, \dots, x_n)$$

and read off $u_{i\kappa}(\mathbf{x}) = f_{\kappa}^{(i)}(\mathbf{x})$. In that case, we have

$$\frac{dx'_i}{dt} = f_{\kappa}^{(i)}(x'_1, \dots, x'_n), \quad x'_i(0) = x_i. \tag{29.30}$$

We shall have occasion to use this formula later.

29.1.5 Integration on Lie Groups

As any other manifold, one can define integration on Lie groups; i.e., one can construct nonvanishing n -forms and use Eq. (28.47) to define integrals on a Lie group G . Because of the left-invariant property of objects on G , it would be helpful if the integration process were also left-invariant. For this to happen, the n -form would have to be left-invariant. It turns out that this can be accomplished more or less uniquely:

Proposition 29.1.37 *Let G be a Lie group of dimension n . Then there exists a left-invariant nonvanishing n -form μ that is unique up to a nonzero multiplicative constant. If G is compact, then μ is also right-invariant and the multiplicative constant can be chosen to be 1.*

Proof Let μ_e be any nonzero n -form on $\mathcal{T}_e(G)$. The desired n -form is the left translation of this form, i.e., $L_{g^{-1}}^* \mu_e$. Indeed, let $\{\mathbf{X}_i\}_{i=1}^n$ be left invariant. Then

$$\begin{aligned} \mu_g(\mathbf{X}_1|_g, \dots, \mathbf{X}_n|_g) &= L_{g^{-1}}^* \mu_e(\mathbf{X}_1|_g, \dots, \mathbf{X}_n|_g) \\ &= \mu_e(L_{g^{-1}*} \mathbf{X}_1|_g, \dots, L_{g^{-1}*} \mathbf{X}_n|_g) \\ &= \mu_e(\mathbf{X}_1|_{g^{-1}g}, \dots, \mathbf{X}_n|_{g^{-1}g}) = \mu_e(\mathbf{X}_1|_e, \dots, \mathbf{X}_n|_e). \end{aligned}$$

This shows that μ is left-invariant. Now note that any other n -form μ'_e on $\mathcal{T}_e(G)$ is a constant multiple of μ_e . Therefore, the corresponding n -form μ'_g will be a constant multiple of μ_g .

Let $x \in G$ and consider $\mu' \equiv R_x^* \mu$. We have

$$L_g^* \mu' = L_g^* \circ R_x^* \mu = R_x^* \circ L_g^* \mu = R_x^* \mu = \mu',$$

where we used the fact that L_g and R_x commute and that μ is left invariant. The equation above shows that μ' is also left-invariant. Therefore, $\mu' = c\mu$. If G is compact, we can integrate both sides and note that $\int_G \mu = \int_G \mu'$ because μ' is related to μ by a change of variable. Therefore, $c = 1$ and $R_x^* \mu = \mu$. □

The left-invariant volume element (nonvanishing n -form) guaranteed by the proposition above is called **Haar measure**. Since all calculations are done using some coordinate system, we give an explicit expression of the Haar measure in terms of coordinates (parameters) of a general Lie group. Let $\mathbf{y} = (y^1, \dots, y^r)$ be the coordinates of the translation of $\mathbf{x} = (x^1, \dots, x^r)$

Haar measure

by $g \in G$. Then we can write $\mathbf{y} = m(\mathbf{g}, \mathbf{x})$, so that $dy^j = (\partial y^j / \partial x^i) dx^i = (\partial m^j / \partial x^i) dx^i$. Therefore,

$$dy^1 \wedge \cdots \wedge dy^r = \det\left(\frac{\partial m^j(\mathbf{g}, \mathbf{x})}{\partial x^i}\right) dx^1 \wedge \cdots \wedge dx^r.$$

In particular, if $\mathbf{x} = 0$, the coordinates of the identity, then \mathbf{y} will be the coordinates of g . So, the volume element at g , denoted by $d^r y$, will be given by

$$d^r y = \det\left(\frac{\partial m^j(\mathbf{g}, \mathbf{x})}{\partial x^i}\right)\Bigg|_{\mathbf{x}=0} d^r x.$$

Note that this is consistent with the geometric definition of the invariant measure given in Proposition 29.1.37 because $L_{g^{-1}*} = L_{g*}^{-1}$ and the matrix of L_g^* is the inverse of the matrix of L_{g*} . The volume element at g , which is invariant on G —and therefore has the same value as at the identity—and which we denote by $d\mu(g)$, will be given by

$$d\mu(g) = d\mu(e) \equiv d^r x = \det^{-1}\left(\frac{\partial m^j(\mathbf{g}, \mathbf{x})}{\partial x^i}\right)\Bigg|_{\mathbf{x}=0} d^r g, \tag{29.31}$$

density functions
associated with Haar
measure

where we have replaced y with the more suggestive g . The volume element $d^r g$ is the ordinary Euclidean volume element of \mathbb{R}^r evaluated at the parameters corresponding to g . The quantity multiplying $d^r g$ is called the **density function**. Note that since we are interested in the derivatives of m^j at small values of \mathbf{x} , we can take the components of \mathbf{x} to be small, and retain them only up to the first order. This will sometimes simplify the calculation of the invariant Haar measure.

Example 29.1.38 From the multiplication rule for the one-dimensional projective group given in Example 29.1.9, we easily find

$$\det\left(\frac{\partial m_i}{\partial b_j}\right)\Bigg|_{\mathbf{b}=0} = \det\begin{pmatrix} a_1 & 0 & a_2 & 0 \\ 0 & a_1 & 0 & a_2 \\ a_3 & 0 & a_4 & 0 \\ 0 & a_3 & 0 & a_4 \end{pmatrix} = (a_1 a_4 - a_2 a_3)^2.$$

Thus the density function is $(a_1 a_4 - a_2 a_3)^{-2}$, and the invariant Haar measure is

$$d\mu(\mathbf{a}) = (a_1 a_4 - a_2 a_3)^{-2} d^4 a.$$

29.2 An Outline of Lie Algebra Theory

The notion of a Lie algebra has appeared on a number of occasions both in our study of vector fields on manifolds and, more recently, in the study of Lie groups in the vicinity of their identity elements. Lie algebras play an

important role in the representation theory of Lie groups as well. It is therefore worth our effort to spend some time getting acquainted with the formal structure and properties of these algebras. We shall restrict our discussion to finite-dimensional Lie algebras.

Definition 29.2.1 A finite-dimensional vector space \mathcal{V} over \mathbb{R} (or \mathbb{C}) is called a **Lie algebra over \mathbb{R} (or \mathbb{C})** if there is a binary operation, called **Lie multiplication**, $[\cdot, \cdot]: \mathcal{V} \times \mathcal{V} \rightarrow \mathcal{V}$ on \mathcal{V} , satisfying

1. $[\mathbf{X}, \mathbf{Y}] = -[\mathbf{Y}, \mathbf{X}]$ for all $\mathbf{X}, \mathbf{Y} \in \mathcal{V}$ (antisymmetry).
2. $[\alpha\mathbf{X} + \beta\mathbf{Y}, \mathbf{Z}] = \alpha[\mathbf{X}, \mathbf{Z}] + \beta[\mathbf{Y}, \mathbf{Z}]$ for $\alpha, \beta \in \mathbb{R}$ (or \mathbb{C}) (linearity).
3. $[\mathbf{X}, [\mathbf{Y}, \mathbf{Z}]] + [\mathbf{Z}, [\mathbf{X}, \mathbf{Y}]] + [\mathbf{Y}, [\mathbf{Z}, \mathbf{X}]] = 0$ (Jacobi identity).

The concepts of a homomorphism, its kernel, its range, etc. are the same as before.

To distinguish Lie algebras from vector spaces, we shall denote the former by lowercase German letters as we have done for the Lie algebras of Lie groups.

Example 29.2.2 Recall from Chap. 3 that an algebra is a vector space with a product. If this product is associative, then one can construct a Lie algebra out of the associative algebra by defining $[\mathbf{a}, \mathbf{b}] \equiv \mathbf{ab} - \mathbf{ba}$. In particular, the matrix algebra under commutation of matrices becomes a Lie algebra, which we denote by $\mathfrak{gl}(n, \mathbb{R})$ [or $\mathfrak{gl}(n, \mathbb{C})$].

Definition 29.2.3 Let \mathfrak{v} be a Lie algebra. A subspace \mathfrak{u} of \mathfrak{v} is called a **subalgebra** if $[\mathbf{X}, \mathbf{Y}] \in \mathfrak{u}$ whenever $\mathbf{X}, \mathbf{Y} \in \mathfrak{u}$. The subspace \mathfrak{u} is called an **ideal** if $[\mathbf{X}, \mathbf{Y}] \in \mathfrak{u}$ whenever either $\mathbf{X} \in \mathfrak{u}$ or $\mathbf{Y} \in \mathfrak{u}$. The **center** \mathfrak{z} of \mathfrak{v} is the collection of all $\mathbf{X} \in \mathfrak{v}$ whose Lie multiplication with all vectors of \mathfrak{v} vanishes. A Lie algebra is **abelian**, or **commutative**, if $\mathfrak{z} = \mathfrak{v}$.

If we choose a basis in the Lie algebra \mathfrak{v} , and express the Lie multiplication of basis vectors as a linear combination of basis vectors, we end up with *basis-dependent* structure constants that satisfy Eq. (29.13). The structure constants completely determine the Lie algebra: Given these constants, one can choose a vector space \mathcal{V} of correct dimension, a basis in that space, and impose the Lie multiplication law among the basis vectors suggested by the structure constants. Once the Lie multiplication law for basis vectors is established, the law for arbitrary vectors follows from linearity of Lie multiplication. This procedure induces a binary operation on \mathcal{V} and turns it into a Lie algebra \mathfrak{v} . Any other algebra so constructed will be isomorphic to \mathfrak{v} .

subalgebra, ideal, and center of a Lie algebra

Knowing the structure constants, one can reconstruct the Lie algebra!

Example 29.2.4 We can classify all two-dimensional Lie algebras by analyzing their structure constants. Let \mathbf{X}_1 and \mathbf{X}_2 be any two linearly independent vectors of the two-dimensional Lie algebra \mathfrak{v} . Write the only nonzero Lie bracket as

$$[\mathbf{X}_1, \mathbf{X}_2] = c_1\mathbf{X}_1 + c_2\mathbf{X}_2.$$

There are two cases to consider: Either $c_1 = 0 = c_2$ or at least one of the constants is nonzero. The first case corresponds to a 2-dimensional abelian Lie algebra:

$$[\mathbf{X}_i, \mathbf{X}_j] = 0 \quad \text{for } i, j = 1, 2.$$

For the second case, suppose $c_1 \neq 0$ and define the vectors

$$\mathbf{X} \equiv c_1 \mathbf{X}_1 + c_2 \mathbf{X}_2, \quad \mathbf{Y} \equiv \mathbf{X}_2/c_1.$$

Then the nonzero Lie bracket becomes $[\mathbf{X}, \mathbf{Y}] = \mathbf{X}$.

The result of Example 29.2.4 is summarized as follows:

Box 29.2.5 *There are only two 2-dimensional Lie algebras given by either one of the following nonzero Lie bracket relations:*

$$[\mathbf{X}_1, \mathbf{X}_2] = 0 \quad \text{or} \quad [\mathbf{X}_1, \mathbf{X}_2] = \mathbf{X}_1.$$

Example 29.2.6 The Pauli spin matrices

$$\sigma_1 = \begin{pmatrix} 0 & 1 \\ 1 & 0 \end{pmatrix}, \quad \sigma_2 = \begin{pmatrix} 0 & -i \\ i & 0 \end{pmatrix}, \quad \sigma_3 = \begin{pmatrix} 1 & 0 \\ 0 & -1 \end{pmatrix}$$

form a Lie algebra under the commutation relation given by

$$[\sigma_j, \sigma_k] = 2i\epsilon_{jkl}\sigma_l.$$

Thus, $c_{jk}^l = 2i\epsilon_{jkl}$. Pauli spin matrices are a basis for $\mathfrak{su}(2)$.

Example 29.2.7 The Lie group $GL(n, \mathbb{R})$ has $\mathfrak{gl}(n, \mathbb{R})$, the set of all real $n \times n$ matrices, as its Lie algebra. The standard basis of this Lie algebra, also called the **Weyl basis**, consists of matrices \mathbf{e}_{ij} that have zeros everywhere except at the ij th position. We therefore have

$$(\mathbf{e}_{ij})_{kl} = \delta_{ik}\delta_{jl}. \quad (29.32)$$

We can readily find the Lie multiplication (commutation relations) for these matrices. We simply need to look at the elements of the matrix of the commutator:

$$\begin{aligned} ([\mathbf{e}_{ij}, \mathbf{e}_{kl}])_{mn} &= (\mathbf{e}_{ij}\mathbf{e}_{kl})_{mn} - (\mathbf{e}_{kl}\mathbf{e}_{ij})_{mn} \\ &= (\mathbf{e}_{ij})_{mr}(\mathbf{e}_{kl})_{rn} - (\mathbf{e}_{kl})_{mr}(\mathbf{e}_{ij})_{rn} \\ &= \delta_{im}\delta_{jr}\delta_{kr}\delta_{ln} - \delta_{km}\delta_{lr}\delta_{ir}\delta_{jn} = \delta_{im}\delta_{jk}\delta_{ln} - \delta_{km}\delta_{li}\delta_{jn} \\ &= (\mathbf{e}_{il})_{mn}\delta_{jk} - (\mathbf{e}_{kj})_{mn}\delta_{li}, \end{aligned}$$

or

$$[\mathbf{e}_{ij}, \mathbf{e}_{kl}] = \delta_{jk}\mathbf{e}_{il} - \delta_{il}\mathbf{e}_{kj}. \tag{29.33}$$

The structure constants, which are naturally double-indexed, can be read off from Eq. (29.33):

$$c_{ij,kl}^{mn} = \delta_{jk}\delta_i^m\delta_l^n - \delta_{il}\delta_k^m\delta_j^n, \tag{29.34}$$

where we have used a superscript for some of the Kronecker deltas to conform to the position of the corresponding index on the LHS.

Example 29.2.8 An important datum is the dimension of the Lie group (or its associated Lie algebra, since they are the same). This datum is not apparent in most cases of interest in which the group is defined in terms of some geometric property. For example, the symplectic group is defined as all linear transformations \mathbf{A} that leave a certain antisymmetric bilinear form invariant (Example 23.2.2). In terms of matrices, we have

$$\mathbf{x}^t \mathbf{J} \mathbf{x}' = \mathbf{x}^t \mathbf{J} \mathbf{x} \quad \Rightarrow \quad \mathbf{x}^t \mathbf{A}^t \mathbf{J} \mathbf{A} \mathbf{x} = \mathbf{x}^t \mathbf{J} \mathbf{x} \quad \forall \mathbf{x} \in \mathbb{R}^{2n}, \quad \mathbf{J} = \begin{pmatrix} 0 & 1 \\ -1 & 0 \end{pmatrix}.$$

It follows that the symplectic group consists of all matrices \mathbf{A} such that

$$\mathbf{A}^t \mathbf{J} \mathbf{A} = \mathbf{J}. \tag{29.35}$$

If we write \mathbf{A} in block form,

$$\mathbf{A} = \begin{pmatrix} \mathbf{A}_{11} & \mathbf{A}_{12} \\ \mathbf{A}_{21} & \mathbf{A}_{22} \end{pmatrix},$$

where \mathbf{A}_{ij} are $n \times n$ matrices, then, Eq. (29.35) becomes

$$\begin{pmatrix} \mathbf{A}_{11}^t & \mathbf{A}_{21}^t \\ \mathbf{A}_{12}^t & \mathbf{A}_{22}^t \end{pmatrix} \begin{pmatrix} 0 & 1 \\ -1 & 0 \end{pmatrix} \begin{pmatrix} \mathbf{A}_{11} & \mathbf{A}_{12} \\ \mathbf{A}_{21} & \mathbf{A}_{22} \end{pmatrix} = \begin{pmatrix} 0 & 1 \\ -1 & 0 \end{pmatrix},$$

or

$$\mathbf{A}_{11}^t \mathbf{A}_{21} = \mathbf{A}_{21}^t \mathbf{A}_{11}, \quad \mathbf{A}_{22}^t \mathbf{A}_{12} = \mathbf{A}_{12}^t \mathbf{A}_{22}, \quad \mathbf{A}_{11}^t \mathbf{A}_{22} - \mathbf{A}_{21}^t \mathbf{A}_{12} = 1. \tag{29.36}$$

For the symplectic algebra $\mathfrak{sp}(2n, \mathbb{R})$, we are interested in the matrix \mathbf{A} when it is close to the identity. This means that

$$\mathbf{A}_{11} = 1 + \epsilon \mathbf{X}_{11}, \quad \mathbf{A}_{22} = 1 + \epsilon \mathbf{X}_{22}, \quad \mathbf{A}_{12} = \epsilon \mathbf{X}_{12}, \quad \mathbf{A}_{21} = \epsilon \mathbf{X}_{21}.$$

Substituting these in Eq. (29.36) and keeping terms linear in ϵ , we obtain the following relations among \mathbf{X}_{ij} :

$$\mathbf{X}_{22}^t = -\mathbf{X}_{11}, \quad \mathbf{X}_{12}^t = \mathbf{X}_{12}, \quad \mathbf{X}_{21}^t = \mathbf{X}_{21}. \tag{29.37}$$

It follows that we need n^2 parameters to describe the $n \times n$ matrices \mathbf{X}_{11} and \mathbf{X}_{22} simultaneously. For the symmetric matrices \mathbf{X}_{12} and \mathbf{X}_{21} , we need $n(n + 1)/2$ independent parameters each. Therefore, the total number of

independent parameters needed for (or the dimension of) the symplectic algebra $\mathfrak{sp}(2n, \mathbb{R})$ is

$$n^2 + 2\frac{n(n+1)}{2} = n(2n+1).$$

Although our attempt is to give a formal discussion of the Lie algebras and their structure in this section, we shall do this with an eye to the eventual utility of this discussion in a better understanding of the Lie algebras of Lie groups. To make the connection between the present formalism and the Lie algebras arising from Lie groups, we shall make heavy use of matrix groups, i.e., $GL(n, \mathbb{R})$ [or $GL(n, \mathbb{C})$] and its subgroups. Equation (29.8) gives a method of finding the matrices of the algebra if those of the group are known:

Box 29.2.9 Differentiate the matrix with respect to a parameter at the identity (where all parameters are set equal to zero) to find the matrix “in the direction” of that parameter.

29.2.1 The Lie Algebras $\mathfrak{o}(p, n - p)$ and $\mathfrak{p}(p, n - p)$

Many of the Lie groups encountered in physical applications are special cases of the (pseudo) orthogonal group $O(p, n - p)$ and its associated Poincaré group $P(p, n - p)$. It is therefore worthwhile to study their Lie algebras in some detail. Introduce the diagonal matrix

$$\eta = \text{diag}(\underbrace{-1, -1, \dots, -1}_{p \text{ times}}, \underbrace{1, 1, \dots, 1}_{n - p \text{ times}})$$

and note that the (pseudo) orthogonal group $O(p, n - p)$ consists of $n \times n$ matrices that leave the bilinear form $\mathbf{x} \cdot \mathbf{x} \equiv \mathbf{x}^t \eta \mathbf{x}$ invariant for $\mathbf{x} \in \mathbb{R}^n$. This means that the matrices A will have to satisfy

$$A^t \eta A = \eta \quad \Rightarrow \quad (\det A)^2 = 1. \tag{29.38}$$

η -orthogonal matrices Such matrices are called **η -orthogonal**. The fact that $O(p, n - p)$ is a group and that $\eta^{-1} = \eta$ can be used to show that

$$A \eta A^t = \eta. \tag{29.39}$$

Example 29.2.10 (The Lorentz group) The group of the special theory of relativity is the full Lorentz group $O(3, 1)$. This is the group of transformations that leave the invariant length⁵

$$\eta^{ij} x_i x_j = -x_1^2 - x_2^2 - x_3^2 + x_4^2 \equiv x_0^2 - x_1^2 - x_2^2 - x_3^2$$

⁵It is common to label the time coordinate with index 0 rather than 4. We shall use this convention.

of a 4-vector $(x_1, x_2, x_3, x_0 = ct)$ invariant. The $(0, 0)$ -components of Eqs. (29.38) and (29.39) yield

$$\begin{aligned} a_{00}^2 - a_{10}^2 - a_{20}^2 - a_{30}^2 &= 1, \\ a_{00}^2 - a_{01}^2 - a_{02}^2 - a_{03}^2 &= 1. \end{aligned} \tag{29.40}$$

Either one of these equations implies that $a_{00} \geq 1$ or $a_{00} \leq -1$. Lorentz transformations for which $a_{00} \geq 1$ are called **orthochronous**. Since $\det \mathbf{1} = +1$ and $\mathbf{1}_{00} = +1$, the identity belongs to the subset consisting of transformations with $\det \mathbf{A} = +1$ and $a_{00} \geq 1$. Such transformations form a subgroup of $O(3, 1)$ called the **proper orthochronous** Lorentz transformations, and have the property that they can be reached continuously from the identity.

orthochronous and proper orthochronous Lorentz transformations

Depending on whether $\mathbf{x} \cdot \mathbf{x} > 0$, $\mathbf{x} \cdot \mathbf{x} < 0$, or $\mathbf{x} \cdot \mathbf{x} = 0$, the vector \mathbf{x} is called **timelike**, **spacelike**, or **null**, respectively. In the special theory of relativity \mathbb{R}^4 becomes the set of **events**. At every event \mathbf{x} the set \mathbb{R}^4 is divided into 5 regions:

1. All events $\mathbf{y} = (y_1, y_2, y_3, y_0)$ to which one can go from \mathbf{x} by material objects, with speed less than c , lie to the future of \mathbf{x} , i.e., $y_0 - x_0 > 0$, and are timelike:

Timelike, spacelike, and null vectors; \mathbb{R}^4 as the set of events

$$(y_0 - x_0)^2 > (y_1 - x_1)^2 + (y_2 - x_2)^2 + (y_3 - x_3)^2.$$

They form a 4-dimensional subset of \mathbb{R}^4 and are said to lie *inside* the **future light cone**.

future light cone

2. All events $\mathbf{y} = (y_1, y_2, y_3, y_0)$ to which one can go from \mathbf{x} only by a light signal lie to the future of \mathbf{x} , i.e., $y_0 - x_0 > 0$, and

$$(y_0 - x_0)^2 - (y_1 - x_1)^2 - (y_2 - x_2)^2 - (y_3 - x_3)^2 = 0.$$

They form a 3-dimensional subset of \mathbb{R}^4 and are said to lie *on* the future light cone.

3. All events $\mathbf{y} = (y_1, y_2, y_3, y_0)$ from which one can come to \mathbf{x} by material objects, with speed less than c , lie in the past of \mathbf{x} , i.e., $x_0 - y_0 > 0$, and are timelike:

$$(x_0 - y_0)^2 > (x_1 - y_1)^2 + (x_2 - y_2)^2 + (x_3 - y_3)^2.$$

They form a 4-dimensional subset of \mathbb{R}^4 and are said to lie *inside* the **past light cone**.

past light cone

4. All events $\mathbf{y} = (y_1, y_2, y_3, y_0)$ from which one can come from \mathbf{x} only by a light signal lie to the past of \mathbf{x} , i.e., $x_0 - y_0 > 0$, and

$$(x_0 - y_0)^2 - (x_1 - y_1)^2 - (x_2 - y_2)^2 - (x_3 - y_3)^2 = 0.$$

They form a 3-dimensional subset of \mathbb{R}^4 and are said to lie *on* the past light cone.

5. All events in the remaining part of \mathbb{R}^4 form a 4-dimensional subset, are spacelike, and cannot be connected to \mathbf{x} by any means. They are said to belong to **elsewhere**.

elsewhere

From a physical standpoint, future and past are observer-independent. Therefore, if y lies in or on the future light cone of x with respect to one observer, it should also do so with respect to all observers. Since observers are connected by Lorentz transformations, we expect the latter to preserve this relation between x and y . Not all elements of $O(3, 1)$ have this property. However, the proper orthochronous transformations do. The details are left as a problem for the reader (see Problem 29.15).

As a prototype of η -orthogonal matrices, consider the matrix obtained from the unit matrix by removing the ii th, ij th, ji th, and jj th elements, and replacing them by an overall 2×2 matrix. The result, denoted by $A^{(ij)}$, will look like

$$A^{(ij)} = \begin{pmatrix} 1 & 0 & \dots & 0 & \dots & 0 & \dots & 0 \\ 0 & 1 & \dots & 0 & \dots & 0 & \dots & 0 \\ \vdots & \vdots & & \vdots & & \vdots & & \vdots \\ 0 & 0 & \dots & a_{ii} & \dots & a_{ij} & \dots & 0 \\ \vdots & \vdots & & \vdots & & \vdots & & \vdots \\ 0 & 0 & \dots & a_{ji} & \dots & a_{jj} & \dots & 0 \\ \vdots & \vdots & & \vdots & & \vdots & & \vdots \\ 0 & 0 & \dots & 0 & \dots & 0 & \dots & 1 \end{pmatrix}.$$

This matrix will transform $(x_1, \dots, x_n) \in \mathbb{R}^n$ according to

$$\begin{aligned} x'_i &= a_{ii}x_i + a_{ij}x_j, & (\text{no summation!}) \\ x'_j &= a_{ji}x_i + a_{jj}x_j, \\ x'_k &= x_k & \text{for } k \neq i, j. \end{aligned}$$

In order for $A^{(ij)}$ to leave the bilinear form $x^t \eta x$ invariant, the 2×2 submatrix $\begin{pmatrix} a_{ii} & a_{ij} \\ a_{ji} & a_{jj} \end{pmatrix}$ must be either a rotation (corresponding to the case where $i, j \leq p$ or $i, j > p$), or a Lorentz boost⁶ (corresponding to the case where $i \leq p$ and $j > p$). In the first case, we have

$$\begin{pmatrix} a_{ii} & a_{ij} \\ a_{ji} & a_{jj} \end{pmatrix} = \begin{pmatrix} \cos \theta & -\sin \theta \\ \sin \theta & \cos \theta \end{pmatrix},$$

and in the second case

$$\begin{pmatrix} a_{ii} & a_{ij} \\ a_{ji} & a_{jj} \end{pmatrix} = \begin{pmatrix} \cosh \xi & -\sinh \xi \\ -\sinh \xi & \cosh \xi \end{pmatrix},$$

where $\xi \equiv \tanh^{-1}(v/c)$ is the “rapidity”.

The matrices of the algebra are obtained by differentiation at $\theta = 0$ (or $\xi = 0$). Denoting these matrices by M_{ij} , we readily find that for the case of rotations, M_{ij} has -1 at the ij th position, $+1$ at the ji th position, and 0

⁶The elementary Lorentz transformations involving only one space dimension.

everywhere else. For the case of boosts, M_{ij} has -1 at the ij th and the ji th position, and 0 everywhere else. Both cases can be described by the single relation

$$(M_{ij})^m{}_l = \eta_{il}\delta_j^m - \eta_{jl}\delta_i^m, \quad M_{ij} = -M_{ji}.$$

It is convenient to have all indices in the lower position. So, we multiply both sides by η_{mk} to obtain

$$(M_{ij})_{kl} = \eta_{il}\eta_{jk} - \eta_{jl}\eta_{ik}, \quad M_{ij} = -M_{ji}. \quad (29.41)$$

We can use Eq. (29.41) to find the Lie multiplication (in this case, matrix commutation relations) for the algebra $\mathfrak{o}(p, n - p)$:

$$[M_{ij}, M_{kl}] = \eta_{ik}M_{jl} - \eta_{il}M_{jk} + \eta_{jl}M_{ik} - \eta_{jk}M_{il}. \quad (29.42)$$

Lie brackets for the algebra $\mathfrak{o}(p, n - p)$

The Lie group $O(p, n - p)$ includes rotations and Lorentz transformation. Another group with considerable significance in physics is the **Poincaré group** $P(p, n - p)$, which includes translations⁷ in space and time as well. An element of $P(p, n - p)$ transforms $\mathbf{x} \in \mathbb{R}^n$ to $\mathbf{x}' = \mathbf{A}\mathbf{x} + \mathbf{u}$, where \mathbf{u} is a column vector representing the translation part of the group. It is convenient to introduce matrices to represent these group operations. This is possible if we represent an element of \mathbb{R}^n as an $(n + 1)$ -column whose last element is an insignificant 1 . Then, the reader may check that a Poincaré transformation can be written as

Poincaré group as $(n + 1) \times (n + 1)$ matrices

$$\begin{pmatrix} \mathbf{x}' \\ 1 \end{pmatrix} = \begin{pmatrix} \mathbf{A} & \mathbf{u} \\ 0 & 1 \end{pmatrix} \begin{pmatrix} \mathbf{x} \\ 1 \end{pmatrix}, \quad (29.43)$$

where \mathbf{A} is the $n \times n$ matrix of $O(p, n - p)$, and \mathbf{u} is an n -dimensional column vector.

The Lie algebra of the Poincaré group is obtained by differentiating the $(n + 1) \times (n + 1)$ matrix of Eq. (29.43). The differentiation of the matrix \mathbf{A} will give $\mathfrak{o}(p, n - p)$ of Eq. (29.42). The translation part will lead to matrices \mathbf{P}_i with matrix elements given by

$$(\mathbf{P}_i)^k{}_l = \delta_i^k \delta_l^{n+1} \Rightarrow (\mathbf{P}_i)_{kl} = \eta_{ik} \delta_l^{n+1}. \quad (29.44)$$

These matrices satisfy the following Lie multiplication rules:

$$[\mathbf{P}_i, \mathbf{P}_j] = 0, \quad [M_{ij}, \mathbf{P}_k] = \eta_{ik}\mathbf{P}_j - \eta_{jk}\mathbf{P}_i.$$

It then follows that the full **Poincaré algebra** $\mathfrak{p}(p, n - p)$ is described by the following Lie brackets:

Lie brackets for the Poincaré algebra $\mathfrak{p}(p, n - p)$

$$\begin{aligned} [M_{ij}, M_{kl}] &= \eta_{ik}M_{jl} - \eta_{il}M_{jk} + \eta_{jl}M_{ik} - \eta_{jk}M_{il}, \\ [M_{ij}, \mathbf{P}_k] &= \eta_{ik}\mathbf{P}_j - \eta_{jk}\mathbf{P}_i, \\ [\mathbf{P}_i, \mathbf{P}_j] &= 0. \end{aligned} \quad (29.45)$$

⁷One can think of the Poincaré group as a subgroup of the group of affine motions in which the matrices belong to $O(p, n - p)$ rather than $GL(n, \mathbb{R})$.

29.2.2 Operations on Lie Algebras

Definition 29.2.11 Let \mathfrak{v} be a Lie algebra. A linear operator $\mathbf{D} : \mathfrak{v} \rightarrow \mathfrak{v}$ satisfying

$$\mathbf{D}[\mathbf{X}, \mathbf{Y}] = [\mathbf{D}\mathbf{X}, \mathbf{Y}] + [\mathbf{X}, \mathbf{D}\mathbf{Y}]$$

is called a **derivation** of \mathfrak{v} .

derivation algebra of a Lie algebra

Although the product of two derivations is not a derivation, their commutator is. Therefore, the set of derivations of a Lie algebra \mathfrak{v} themselves form a Lie algebra $\mathfrak{D}_{\mathfrak{v}}$ under commutations, which is called the **derivation algebra**.

adjoint algebra of a Lie algebra

Recall that the infinitesimal generators of the adjoint action of a Lie group on its algebra were given by \mathfrak{ad}_{ξ} [Eq. (29.18)]. We can apply this to a general Lie algebra \mathfrak{v} by fixing a vector $\mathbf{X} \in \mathfrak{v}$ and defining the map $\mathfrak{ad}_{\mathbf{X}} : \mathfrak{v} \rightarrow \mathfrak{v}$ given by $\mathfrak{ad}_{\mathbf{X}}(\mathbf{Y}) = [\mathbf{X}, \mathbf{Y}]$. The reader may verify that $\mathfrak{ad}_{\mathbf{X}}$ is a derivation of \mathfrak{v} and that $\mathfrak{ad}_{[\mathbf{X}, \mathbf{Y}]} = [\mathfrak{ad}_{\mathbf{X}}, \mathfrak{ad}_{\mathbf{Y}}]$. Therefore, the set $\mathfrak{ad}_{\mathfrak{v}} \equiv \{\mathfrak{ad}_{\mathbf{X}} \mid \mathbf{X} \in \mathfrak{v}\}$ is a Lie algebra, a subalgebra of the derivation algebra $\mathfrak{D}_{\mathfrak{v}}$ of \mathfrak{v} , and is called the **adjoint algebra** of \mathfrak{v} . There is a natural homomorphism $\psi : \mathfrak{v} \rightarrow \mathfrak{ad}_{\mathfrak{v}}$ given by $\psi(\mathbf{X}) = \mathfrak{ad}_{\mathbf{X}}$ whose kernel is the center of \mathfrak{v} . Furthermore, $\mathfrak{ad}_{\mathfrak{v}}$ is an *ideal* of $\mathfrak{D}_{\mathfrak{v}}$.

Illustration of homomorphism of $\mathfrak{su}(2)$ and its adjoint using Pauli spin matrices

Example 29.2.12 We construct the matrix representation of the operators in the adjoint algebra of $\mathfrak{su}(2)$ with Pauli spin matrices as a basis. From

$$\mathfrak{ad}_{\sigma_1}(\sigma_1) = [\sigma_1, \sigma_1] = 0$$

we conclude that the first column of the matrix of \mathfrak{ad}_{σ_1} is zero. From

$$\mathfrak{ad}_{\sigma_1}(\sigma_2) = [\sigma_1, \sigma_2] = 2i\sigma_3$$

we conclude that the second column of the matrix of \mathfrak{ad}_{σ_1} has zeros for the first two elements and $2i$ for the last. Similarly, from

$$\mathfrak{ad}_{\sigma_1}(\sigma_3) = [\sigma_1, \sigma_3] = -2i\sigma_2$$

we conclude that the third column of the matrix of \mathfrak{ad}_{σ_1} has zeros for the first and third elements and $-2i$ for the second. Thus, the matrix representation of \mathfrak{ad}_{σ_1} is

$$\mathfrak{ad}_{\sigma_1} = \begin{pmatrix} 0 & 0 & 0 \\ 0 & 0 & -2i \\ 0 & 2i & 0 \end{pmatrix}.$$

Likewise, we can obtain the other two matrix representations; they are

$$\mathfrak{ad}_{\sigma_2} = \begin{pmatrix} 0 & 0 & 2i \\ 0 & 0 & 0 \\ -2i & 0 & 0 \end{pmatrix}, \quad \mathfrak{ad}_{\sigma_3} = \begin{pmatrix} 0 & -2i & 0 \\ 2i & 0 & 0 \\ 0 & 0 & 0 \end{pmatrix}.$$

The reader may readily verify that $[\mathfrak{ad}_{\sigma_j}, \mathfrak{ad}_{\sigma_k}] = 2i\epsilon_{jkl}\mathfrak{ad}_{\sigma_l}$.

If ψ is an automorphism of \mathfrak{v} , i.e., an isomorphism of \mathfrak{v} onto itself, then

$$\text{ad}_{\psi(\mathbf{X})} = \psi \circ \text{ad}_{\mathbf{X}} \circ \psi^{-1} \quad \forall \mathbf{X} \in \mathfrak{v}. \tag{29.46}$$

Since $\text{ad}_{\mathbf{X}}$ is an operator on the vector space \mathfrak{v} , one can define the trace of $\text{ad}_{\mathbf{X}}$. However, the notion of trace attains a far greater significance when it is combined with the notion of composition of operators. For $\mathbf{X}, \mathbf{Y} \in \mathfrak{v}$, define

$$(\mathbf{X} | \mathbf{Y}) \equiv \text{tr}(\text{ad}_{\mathbf{X}} \circ \text{ad}_{\mathbf{Y}}). \tag{29.47}$$

Then one can show that $(\cdot | \cdot)$ is bilinear and symmetric. It becomes an inner product if the “vectors” of the Lie algebra are hermitian operators on some vector space \mathcal{V} , or if the underlying vector space is over \mathbb{R} (see Proposition 5.6.6 in Chap. 5). Furthermore, $(\cdot | \cdot)$ satisfies

$$([\mathbf{X}, \mathbf{Y}] | \mathbf{Z}) + ([\mathbf{X}, \mathbf{Z}] | \mathbf{Y}) = 0. \tag{29.48}$$

Definition 29.2.13 The symmetric bilinear form $(\cdot | \cdot) : \mathfrak{v} \times \mathfrak{v} \rightarrow \mathbb{C}$ defined by (29.47) is called the **Killing form** of \mathfrak{v} . Killing form of a Lie algebra

It is an immediate consequence of this definition and Eq. (29.46) that the Killing form of \mathfrak{v} is invariant under all automorphisms of \mathfrak{v} .

As noted above, the Killing form is an *inner product* if the Lie algebra consists of hermitian operators. This will certainly happen if the Lie algebra is that of a group whose elements are unitary operators on some vector space \mathcal{V} . We shall see shortly that such unitary operators are not only possible, but have extremely useful properties in the representation of compact Lie groups. A unitary representation of a Lie group induces a representation of its Lie algebra whose “vectors” are hermitian operators. Then the Killing form becomes an inner product. The natural existence of such Killing forms for the representation of a *compact* Lie group motivates the following:

Definition 29.2.14 A Lie algebra \mathfrak{v} is **compact** if it has an *inner product* $(\cdot | \cdot)$ satisfying compact Lie algebra

$$([\mathbf{X}, \mathbf{Y}] | \mathbf{Z}) + ([\mathbf{X}, \mathbf{Z}] | \mathbf{Y}) = 0.$$

Choose a basis $\{\mathbf{X}_i\}$ for the Lie algebra \mathfrak{v} and note that $(\text{ad}_{\mathbf{X}_i})_j^k = c_{ij}^k$. Therefore,

$$(\mathbf{X}_i | \mathbf{X}_j) \equiv \text{tr}(\text{ad}_{\mathbf{X}_i} \circ \text{ad}_{\mathbf{X}_j}) = (\text{ad}_{\mathbf{X}_i})_l^k (\text{ad}_{\mathbf{X}_j})_k^l = c_{il}^k c_{jk}^l \equiv g_{ij}, \tag{29.49}$$

where g_{ij} are components of the so-called **Cartan metric tensor** in the basis $\{\mathbf{X}_i\}$. If $\mathbf{A}, \mathbf{B} \in \mathfrak{v}$ have components $\{a^i\}$ and $\{b^i\}$ in the basis $\{\mathbf{X}_i\}$, then it follows from Eq. (29.49) that Cartan metric tensor of a Lie algebra

$$(\mathbf{A} | \mathbf{B}) = a^i b^j g_{ij}, \tag{29.50}$$

as expected of a symmetric bilinear form. We can use the Cartan metric to lower the upper index of the structure constants: $c_{ijk} \equiv c_{ij}^l g_{lk}$. By virtue of

Eq. (29.49), the new constants may be written in the form

$$\begin{aligned} c_{ijk} &= c_{ij}^l c_{ls}^r c_{kr}^s = (-c_{js}^l c_{li}^r - c_{si}^l c_{lj}^r) c_{kr}^s \quad \text{by (29.13)} \\ &= c_{js}^l c_{il}^r c_{kr}^s + c_{si}^l c_{lj}^r c_{kr}^s. \end{aligned}$$

The reader may now verify that the RHS is completely antisymmetric in i , j , and k . If the Lie algebra is compact, then one can choose an orthonormal basis in which $g_{lk} = \delta_{lk}$ (because the inner product is, by definition, positive definite) and obtain $c_{ij}^k = c_{ijk}$. We therefore have the following result.

Proposition 29.2.15 *Let \mathfrak{v} be a compact Lie algebra. Then there exists a basis of \mathfrak{v} in which the structure constants are represented by a third-order completely antisymmetric covariant tensor.*



Wilhelm Karl Joseph Killing 1847–1923

Historical Notes

Most mathematicians seem to have little or no interest in history, so that often the name attached to a key result is that of the follow-up person who exploited an idea or theorem rather than its originator (the Jordan form is due to Weierstrass, Wedderburn theory to Cartan and Molien). No one has suffered from this ahistoricism more than Killing. For example, the so-called “Cartan sub-algebra” and “Cartan matrix” were defined and exploited by Killing. He exhibited the characteristic equation of an arbitrary element of the Weyl group when Weyl was 3 years old and listed the orders of the Coxeter transformation 19 years before Coxeter was born!

Wilhelm Karl Joseph Killing (1847–1923) began university study in Münster in 1865 but quickly moved to Berlin and came under the influence of Kummer and Weierstrass. From 1868 to 1882 much of Killing’s energy was devoted to teaching at the gymnasium level in Berlin and Brilon (south of Münster). At one stage, when Weierstrass was urging him to write up his research on space structures, he was spending as much as 36 hours per week in the classroom or tutoring. (Now many mathematicians consider 6 hours a week an intolerable burden!) On the recommendation of Weierstrass, Killing was appointed professor of mathematics at the Lyzeum Hosianum in Braunsberg, in East Prussia (now Braniewo in the region of Olsztyn, in Poland). This was a college founded in 1565 by Bishop Stanislaus Hosius, whose treatise on the Christian faith ran to 39 editions! The main object of the college was the training of Roman Catholic clergy, so Killing had to teach a wide range of topics, including the reconciliation of faith and science. Although he was isolated mathematically during his ten years in Braunsberg, this was the most creative period in his mathematical life. Killing produced his brilliant work despite worries about the health of his wife and seven children, demanding administrative duties as rector of the college and as a member and chairman of the City Council, and his active role in the Church of St. Catherine.

What we now call Lie algebras were invented by the Norwegian mathematician Sophus Lie about 1870 and independently by Killing about 1880. Lie was seeking to develop an approach to the solution of differential equations analogous to the Galois theory of algebraic equations. Killing’s consuming passion was non-Euclidean geometries and their generalizations, so he was led to the problem of classifying infinitesimal motions of a rigid body in any type of space (or *Raumformen*, as he called them).

In 1892 he was called back to his native Westphalia as professor of mathematics at the University of Münster, where he was quickly submerged in teaching, administration, and charitable activities. He was Rector Magnificus for some period and president of the St. Vincent de Paul charitable society for ten years. Killing’s work was neglected partly because he was a modest man with high standards; he vastly underrated his own achievement. His interest was geometry, and for this he needed all real Lie algebras. To obtain merely the simple Lie algebras over the complex numbers did not appear to him to be very significant. Another reason was due to Lie, who was quite negative about Killing’s work. At the top of page 770 of a three-volume joint work of Lie and Engel we find the

following less than generous comment about Killing: “With the exception of the preceding unproved theorem . . . all the theorems that are correct are due to Lie and all the false ones are due to Killing!”

Killing was conservative in his political views and vigorously opposed the attempt to reform the examination requirements for graduate students at the University of Münster by deleting the compulsory study of philosophy. Engel comments “Killing could not see that for most candidates the test in philosophy was completely worthless.” He had a profound patriotic love of his country, so that his last years (1918–1923) were deeply pained by the collapse of social cohesion in Germany after the War of 1914–18.

(Taken from A.J. Coleman, “The Greatest Mathematical Paper of All Times,” *Mathematical Intelligencer* **11**(3) (1989) 29–38.)

Example 29.2.16 We can calculate explicitly the Killing form of the Lie algebras $\mathfrak{gl}(n, \mathbb{R})$ and $\mathfrak{sl}(n, \mathbb{R})$. Choose the Weyl basis introduced in Example 29.2.7 and expand $A, B \in \mathfrak{gl}(n, \mathbb{R})$ in terms of the Weyl basis vectors: $A = a^{ij} e_{ij}$, $B = b^{ij} e_{ij}$. The Cartan metric tensor becomes

$$g_{ij,kl} = c_{ij,mn}^{rs} c_{kl,rs}^{mn} = (\delta_{jm} \delta_i^r \delta_n^s - \delta_{in} \delta_m^r \delta_j^s) (\delta_{lr} \delta_k^m \delta_s^n - \delta_{ks} \delta_r^m \delta_l^n),$$

where we have used Eq. (29.34). It follows from these relations, Eq. (29.50), and a simple index manipulation that

$$(A | B) \equiv a^{ij} b^{kl} g_{ij,kl} = 2n \operatorname{tr}(AB) - 2 \operatorname{tr} A \operatorname{tr} B \tag{29.51}$$

for $A, B \in \mathfrak{gl}(n, \mathbb{R})$, and

$$(A | B) = 2n \operatorname{tr}(AB) \tag{29.52}$$

for $A, B \in \mathfrak{sl}(n, \mathbb{R})$, because all matrices in $\mathfrak{sl}(n, \mathbb{R})$ are traceless.

A Lie algebra \mathfrak{v} , as a vector space, may be written as a direct sum of its subspaces. We express this as

$$\mathfrak{v} = \mathfrak{u}_1 \oplus_{\mathfrak{V}} \mathfrak{u}_2 \oplus_{\mathfrak{V}} \cdots \oplus_{\mathfrak{V}} \mathfrak{u}_r = \sum_{k=1}^r \oplus_{\mathfrak{V}} \mathfrak{u}_k.$$

If in addition $\{\mathfrak{u}_k\}$ are Lie subalgebras every one of which commutes with the rest, we write

$$\mathfrak{v} = \mathfrak{u}_1 \oplus \mathfrak{u}_2 \oplus \cdots \oplus \mathfrak{u}_r \equiv \bigoplus_{k=1}^r \mathfrak{u}_k \tag{29.53}$$

and say that \mathfrak{v} has been **decomposed** into a direct sum of Lie algebras. In this case, each \mathfrak{u}_k is not only a subalgebra, but also an ideal of \mathfrak{v} (see Proposition 3.2.11).

The study of the structure of Lie algebras boils down to the study of the “simplest” kind of Lie algebras in terms of which other Lie algebras can be decomposed. Intuitively, one would want to call a Lie algebra “simple” if it has no proper subalgebras. However, in terms of decomposition, such subalgebras are required to be ideals. So the natural definition of a simple Lie algebra would be the following (see Definition 3.2.12):

semisimple Lie algebras **Definition 29.2.17** A Lie algebra that has no proper ideal is called a **simple** Lie algebra. A Lie algebra is **semisimple** if it has no (nonzero) commutative ideal.

For example, the pseudo-orthogonal algebra $\mathfrak{o}(p, n - p)$ is semisimple, but the Poincaré algebra $\mathfrak{p}(p, n - p)$ is not because the translation generators \mathbf{P}_j form a commutative ideal.

A useful criterion for semisimplicity is given by the following theorem due to Cartan, which we state without proof (for a proof, see [Baru 86, pp. 15–16]):

Theorem 29.2.18 (Cartan) *A Lie algebra \mathfrak{v} is semisimple iff $\det(g_{ij}) \neq 0$.*

The importance of semisimple Lie algebras is embodied in the following theorem: [Baru 86, pp. 19–20].

Theorem 29.2.19 (Cartan) *A semisimple complex or real Lie algebra can be decomposed into a direct sum of pairwise orthogonal simple subalgebras. This decomposition is unique up to ordering.*

This is the analogue of Theorem 3.5.25.

The orthogonality is with respect to the Killing form. Theorem 29.2.19 reduces the study of semisimple Lie algebras to that of simple Lie algebras. What about a general Lie algebra \mathfrak{v} ? If \mathfrak{v} is compact, then it turns out that it can be written as $\mathfrak{v} = \mathfrak{z} \oplus \mathfrak{s}$ where \mathfrak{z} is the center of \mathfrak{v} and \mathfrak{s} is semisimple. If \mathfrak{v} is not compact, then the decomposition will not be in terms of a direct sum, but in terms of what is called a *semidirect* sum one of whose factors is semisimple. For details, the reader is referred to the fairly accessible treatment of Barut and Raczka, Chap. 2. From now on we shall restrict our discussion to semisimple Lie algebras. These algebras are completely known, because simple algebras have been completely classified. We shall not pursue the classification of Lie algebras. However, we simply state a definition that is used in such a classification, because we shall have an occasion to use it in the representation theory of Lie algebras.

Cartan subalgebra and the rank of a Lie algebra **Definition 29.2.20** Let \mathfrak{v} be a Lie algebra. A subalgebra \mathfrak{h} of \mathfrak{v} is called a **Cartan subalgebra** if \mathfrak{h} is the largest commutative subalgebra of \mathfrak{v} , and for all $\mathbf{X} \in \mathfrak{h}$, if $\text{ad}_{\mathbf{X}}$ leaves a subspace of \mathfrak{v} invariant, then it leaves the complement of \mathfrak{v} invariant as well. The dimension of \mathfrak{h} is called the **rank** of \mathfrak{v} .

29.3 Problems

29.1 Show that the set $G = GL(n, \mathbb{R}) \times \mathbb{R}^n$ equipped with the “product”

$$(\mathbf{A}, \mathbf{u})(\mathbf{B}, \mathbf{v}) \equiv (\mathbf{AB}, \mathbf{Av} + \mathbf{u})$$

affine group forms a group. This is called the **affine group**.

29.2 Show that $m : U \times U \rightarrow \mathbb{R}$ defined in Example 29.1.5 is a local Lie group.

29.3 Find the multiplication law for the groups in (b) and (c) of Example 29.1.9.

29.4 Show that the one-dimensional projective group of Example 29.1.9 satisfies all the group properties. In particular, find the identity and the inverse of an element in the group.

29.5 Let G be a Lie group. Let S be a subgroup of G that is also a submanifold of G . Show that S is a Lie group.

29.6 Show that the differential map of $\psi : GL(\mathcal{V}) \rightarrow \mathcal{H}(\mathcal{V})$, defined by $\psi(\mathbf{A}) = \mathbf{A}\mathbf{A}^\dagger$, where $\mathcal{H}(\mathcal{V})$ is the set of hermitian operators on \mathcal{V} , is surjective. Derive Eq. (29.11).

29.7 Verify that $I_g \equiv R_g^{-1} \circ L_g$ is an isomorphism.

29.8 Prove Proposition 29.1.24.

29.9 Start with Eq. (29.24) and use the fact that second derivative is independent of the order of differentiation to obtain

$$u_{i\kappa} \left[\frac{\partial \theta_{\kappa\mu}^{-1}}{\partial a_\lambda} - \frac{\partial \theta_{\kappa\lambda}^{-1}}{\partial a_\mu} \right] + \theta_{\kappa\mu}^{-1} \frac{\partial u_{i\kappa}}{\partial a_\lambda} - \theta_{\kappa\lambda}^{-1} \frac{\partial u_{i\kappa}}{\partial a_\mu} = 0.$$

Now use the chain rule $\partial u_{i\kappa} / \partial a_\lambda = (\partial u_{i\kappa} / \partial x_j)(\partial x_j / \partial a_\lambda)$ and Eq. (29.24) to get

$$u_{i\kappa} \left[\frac{\partial \theta_{\kappa\mu}^{-1}}{\partial a_\lambda} - \frac{\partial \theta_{\kappa\lambda}^{-1}}{\partial a_\mu} \right] + \left[u_{j\nu} \frac{\partial u_{i\kappa}}{\partial x_j} - u_{j\kappa} \frac{\partial u_{i\nu}}{\partial x_j} \right] \theta_{\kappa\mu}^{-1} \theta_{\nu\lambda}^{-1} = 0,$$

or

$$u_{j\sigma} \frac{\partial u_{i\tau}}{\partial x_j} - u_{j\tau} \frac{\partial u_{i\sigma}}{\partial x_j} = c_{\sigma\tau}^\kappa(\mathbf{a}) u_{i\kappa}(\mathbf{x}), \tag{29.54}$$

where

$$c_{\sigma\tau}^\kappa(\mathbf{a}) = \left[\frac{\partial \theta_{\kappa\mu}^{-1}}{\partial a_\lambda} - \frac{\partial \theta_{\kappa\lambda}^{-1}}{\partial a_\mu} \right] \theta_{\mu\sigma} \theta_{\lambda\tau}.$$

Substituting Eq. (29.54) in Eq. (29.26) leads to (29.27). Now differentiate both sides of Eq. (29.54) with respect to a_ρ to get

$$\frac{\partial c_{\sigma\tau}^\kappa}{\partial a_\rho} u_{i\kappa} = 0.$$

With the assumption that the $u_{i\kappa}$ are linearly independent, conclude that the structure “constants” are indeed constants.

29.10 Using

$$\begin{aligned}x'_1 &\equiv \phi_1(x_1, x_2, x_3; \theta, \varphi, \psi), \\x'_2 &\equiv \phi_2(x_1, x_2, x_3; \theta, \varphi, \psi), \\x'_3 &\equiv \phi_3(x_1, x_2, x_3; \theta, \varphi, \psi),\end{aligned}$$

obtained from the multiplication of the column vector consisting of x_1 , x_2 , and x_3 by the Euler matrix of Example 5.2.7 and employing Eq. (29.25), find the three components of the angular momentum.

29.11 Find the invariant Haar measure of the general linear group in two dimensions.

29.12 Show that the invariant Haar measure for a compact group satisfies $d\mu_g = d\mu_{g^{-1}}$. Hint: Define a measure ν by $d\nu_g \equiv d\mu_{g^{-1}}$ and show that ν is left-invariant. Now use the uniqueness of the left-invariant Haar measure for compact groups.

29.13 Show that $O(p, n - p)$ is a group. Use this and the fact that $\eta^{-1} = \eta$ to show that $A\eta A^t = \eta$.

29.14 Show that the orthogonal group $O(p, n - p)$ has dimension $n(n - 1)/2$. Hint: Look at its algebra $\mathfrak{o}(p, n - p)$.

29.15 Let $\mathbf{x} = (x_1, x_2, x_3, x_0)$ be a timelike (null, isotropic) 4-vector with $x_0 > 0$. Let A be a proper orthochronous transformation. Show that $\mathbf{x}' = A\mathbf{x}$ is also timelike (null). Hint: Consider the zeroth component of \mathbf{x}' as an inner product of (x_1, x_2, x_3, x_0) and another vector and use Schwarz inequality.

29.16 Starting with the definition of each matrix, derive Eq. (29.45).

29.17 Let \mathbf{D}_1 and \mathbf{D}_2 be derivations of a Lie algebra \mathfrak{v} . Show that $\mathbf{D}_1\mathbf{D}_2 \equiv \mathbf{D}_1 \circ \mathbf{D}_2$ is not a derivation, but $[\mathbf{D}_1, \mathbf{D}_2]$ is.

29.18 Let \mathfrak{v} be a Lie algebra. Verify that $\text{ad}_{\mathbf{X}}$ is a derivation of \mathfrak{v} for any $\mathbf{X} \in \mathfrak{v}$, and that $\text{ad}_{[\mathbf{X}, \mathbf{Y}]} = [\text{ad}_{\mathbf{X}}, \text{ad}_{\mathbf{Y}}]$.

29.19 Show that $\psi : \mathfrak{v} \rightarrow \mathfrak{ad}_{\mathfrak{v}}$ given by $\psi(\mathbf{X}) = \text{ad}_{\mathbf{X}}$ is (a) a homomorphism, (b) $\ker \psi$ is the center of \mathfrak{v} , and (c) $\mathfrak{ad}_{\mathfrak{v}}$ is an ideal of $\mathfrak{D}_{\mathfrak{v}}$.

29.20 Show that if ψ is an automorphism of \mathfrak{v} , then

$$\text{ad}_{\psi(\mathbf{X})} = \psi \circ \text{ad}_{\mathbf{X}} \circ \psi^{-1} \quad \forall \mathbf{X} \in \mathfrak{v}.$$

Hint: Apply both sides to an arbitrary element of \mathfrak{v} .

29.21 Show that for *any* Lie algebra,

$$c_{ijk} = c_{js}^l c_{il}^r c_{kr}^s + c_{si}^l c_{lj}^r c_{rk}^s$$

is completely antisymmetric in all its indices.

29.22 Show that the Killing form of \mathfrak{v} is invariant under all automorphisms of \mathfrak{v} .

29.23 Show that the translation generators \mathbf{P}_j of the Poincaré algebra $\mathfrak{p}(p, n - p)$ form a commutative ideal.

29.24 Find the Cartan metrics for $\mathfrak{o}(3, 1)$ and $\mathfrak{p}(3, 1)$, and show directly that the first is semisimple but the second is not.

The representation of Lie groups is closely related to the representation of their Lie *algebras*, and we shall discuss them later in this chapter. In the case of *compact* groups, however, there is a well developed representation theory, which we shall consider in the first section. Before discussing compact groups, let us state a definition and a proposition that hold for *all* Lie groups.

Definition 30.0.1 A **representation** of a Lie group G on a Hilbert space \mathcal{H} is a Lie group homomorphism $T : G \rightarrow GL(\mathcal{H})$. Similarly, a representation of the Lie algebra \mathfrak{g} is a Lie algebra homomorphism $\mathfrak{T} : \mathfrak{g} \rightarrow \mathfrak{gl}(\mathcal{H})$.

The proposition we have in mind is the important **Schur’s lemma** which we state without proof (for a proof see [Baru 86, pp. 143–144]).

Proposition 30.0.2 (Schur’s lemma) *A unitary representation $T : G \rightarrow GL(\mathcal{H})$ of a Lie group G is irreducible if and only if the only operators commuting with all the T_g are scalar multiples of the unit operator.* Schur’s lemma

30.1 Representation of Compact Lie Groups

In this section, we shall consider the representation of compact Lie *groups*, because for such groups, many of the ideas developed for finite groups hold.

Example 30.1.1 (Compactness of $U(n)$, $O(n)$, $SU(n)$, and $SO(n)$) Identify $GL(n, \mathbb{C})$ with \mathbb{R}^{2n^2} via components. The map

$$f : GL(n, \mathbb{C}) \rightarrow GL(n, \mathbb{C}) \quad \text{given by } f(A) = AA^\dagger$$

is continuous because it is simply the products of elements of matrices. It follows that $f^{-1}(1)$ is closed, because the matrix 1 is a single point in \mathbb{R}^{2n^2} , which is therefore closed. $f^{-1}(1)$ is also bounded, because

$$AA^\dagger = 1 \quad \Rightarrow \quad \sum_{j=1}^n a_{ij}a_{kj}^* = \delta_{ik} \quad \Rightarrow \quad \sum_{i,j=1}^n |a_{ij}|^2 = n.$$

Thus, $f^{-1}(1)$ is a $(2n^2 - 1)$ -dimensional sphere of radius \sqrt{n} in \mathbb{R}^{2n^2} , which is clearly bounded. The BWHB theorem (of Chap. 17) now implies that $f^{-1}(1)$ is compact. Now note that $f^{-1}(1)$ consists of all matrices that have their hermitian adjoints for an inverse; but these are precisely the set $U(n)$ of unitary matrices.

Now consider the map $\det : U(n) \rightarrow \mathbb{C}$. This map is also continuous, implying that $\det^{-1}(1)$ is a closed subset of $U(n)$. The boundedness of $U(n)$ implies that $\det^{-1}(1)$ is also bounded. Invoking the BWHB theorem again, we conclude that $\det^{-1}(1) = SU(n)$, being closed and bounded, is compact.

If instead of complex numbers, we restrict ourselves to the reals, $O(n)$ and $SO(n)$ will replace $U(n)$ and $SU(n)$, respectively.

The result of the example above can be summarized:

Box 30.1.2 *The unitary $U(n)$, orthogonal $O(n)$, special unitary $SU(n)$, and special orthogonal $SO(n)$ groups are all compact.*

We now start our study of the representations of compact Lie groups. We first show that we can always assume that the representation is unitary.

All representations of compact groups can be made unitary.

Theorem 30.1.3 *Let $T : G \rightarrow GL(\mathcal{H})$ be any representation of the compact group G . There exists a new inner product in \mathcal{H} relative to which T is unitary.*

Proof Let $\langle | \rangle$ be the initial inner product. Define a new inner product $(|)$ by

$$(u|v) \equiv \int_G \langle \mathbf{T}_g u | \mathbf{T}_g v \rangle d\mu_g$$

where $d\mu_g$ is the Haar measure, which is both left- and right-invariant. The reader may check that this is indeed an inner product. For every $h \in G$, we have

$$\begin{aligned} (\mathbf{T}_h u | \mathbf{T}_h v) &= \int_G \langle \mathbf{T}_g \mathbf{T}_h u | \mathbf{T}_g \mathbf{T}_h v \rangle d\mu_g \\ &= \int_G \langle \mathbf{T}_{gh} u | \mathbf{T}_{gh} v \rangle d\mu_g \quad (\text{because } T \text{ is a representation}) \\ &= \int_G \langle \mathbf{T}_{gh} u | \mathbf{T}_{gh} v \rangle d\mu_{gh} \quad (\text{because } \mu_g \text{ is right invariant}) \\ &= (u|v). \end{aligned}$$

This shows that \mathbf{T}_h is unitary for all $h \in G$. □

From now on, we shall restrict our discussion to unitary representations of compact groups.

The study of representations of compact groups is facilitated by the following construction:

Definition 30.1.4 Let $T : G \rightarrow GL(\mathcal{H})$ be a unitary representation of the compact group G and $|u\rangle \in \mathcal{H}$ a fixed vector. The **Weyl operator** \mathbf{K}_u associated with $|u\rangle$ is defined as

Weyl operator for a compact Lie group

$$\mathbf{K}_u = \int_G |\mathbf{T}_g u\rangle \langle \mathbf{T}_g u| d\boldsymbol{\mu}_g. \quad (30.1)$$

The essential properties of the Weyl operator are summarized in the following:

Proposition 30.1.5 Let $T : G \rightarrow GL(\mathcal{H})$ be a unitary representation of the compact group G . Then the Weyl operator has the following properties

1. \mathbf{K}_u is hermitian.
2. $\mathbf{K}_u \mathbf{T}_g = \mathbf{T}_g \mathbf{K}_u$ for all $g \in G$. Therefore, any eigenspace of \mathbf{K}_u is an invariant subspace of all \mathbf{T}_g 's.
3. \mathbf{K}_u is a Hilbert-Schmidt operator.

Proof Statement (1), in the form $\langle w|\mathbf{K}_u|v\rangle^* = \langle v|\mathbf{K}_u|w\rangle$, follows directly from the definition.

(2) From $\mathbf{T}_g \int_G |\mathbf{T}_x u\rangle \langle \mathbf{T}_x u| d\boldsymbol{\mu}_x = \int_G |\mathbf{T}_g \mathbf{T}_x u\rangle \langle \mathbf{T}_x u| d\boldsymbol{\mu}_x$, the fact that T is a representation (therefore, $\mathbf{T}_g \mathbf{T}_x = \mathbf{T}_{gx}$), and redefining the integration variable to $y = gx$, we get

$$\mathbf{T}_g \mathbf{K}_u = \int_G |\mathbf{T}_y u\rangle \langle \mathbf{T}_{g^{-1}y} u| \underbrace{d\boldsymbol{\mu}_{g^{-1}y}}_{=d\boldsymbol{\mu}_y} = \int_G |\mathbf{T}_y u\rangle \langle \mathbf{T}_{g^{-1}} \mathbf{T}_y u| d\boldsymbol{\mu}_y,$$

where we used the left invariance of $\boldsymbol{\mu}$ and the fact that T is a representation. Unitarity of T now gives

$$\mathbf{T}_g \mathbf{K}_u = \int_G |\mathbf{T}_y u\rangle \langle \mathbf{T}_g^\dagger \mathbf{T}_y u| d\boldsymbol{\mu}_y = \int_G |\mathbf{T}_y u\rangle \langle \mathbf{T}_y u| \mathbf{T}_g d\boldsymbol{\mu}_y = \mathbf{K}_u \mathbf{T}_g.$$

(3) Recall that an operator $\mathbf{A} \in \mathcal{L}(\mathcal{H})$ is Hilbert-Schmidt if $\sum_{i=1}^{\infty} \|\mathbf{A}|e_i\rangle\|^2$ is finite for any orthonormal basis $\{|e_i\rangle\}$ of \mathcal{H} . In the present case, we have

$$\mathbf{K}_u |e_i\rangle = \int_G |\mathbf{T}_x u\rangle \langle \mathbf{T}_x u| e_i\rangle d\boldsymbol{\mu}_x.$$

Therefore,

$$\begin{aligned} \sum_{i=1}^{\infty} \|\mathbf{K}_u |e_i\rangle\|^2 &= \sum_{i=1}^{\infty} \left(\int_G \langle e_i | \mathbf{T}_y u\rangle \langle \mathbf{T}_y u| d\boldsymbol{\mu}_y \right) \left(\int_G |\mathbf{T}_x u\rangle \langle \mathbf{T}_x u| e_i\rangle d\boldsymbol{\mu}_x \right) \\ &= \sum_{i=1}^{\infty} \int_G \int_G \langle e_i | \mathbf{T}_y u\rangle \langle \mathbf{T}_y u| \mathbf{T}_x u\rangle \langle \mathbf{T}_x u| e_i\rangle d\boldsymbol{\mu}_x d\boldsymbol{\mu}_y. \end{aligned}$$

If we switch the order of summation and integration and use

$$\sum_{i=1}^{\infty} \langle \mathbf{T}_x u| e_i\rangle \langle e_i | \mathbf{T}_y u\rangle = \langle \mathbf{T}_x u| \mathbf{T}_y u\rangle,$$

we obtain

$$\sum_{i=1}^{\infty} \|\mathbf{K}_u |e_i\rangle\|^2 = \int_G \int_G |\langle \mathbf{T}_y u | \mathbf{T}_x u \rangle|^2 d\mu_x d\mu_y,$$

and using the Schwarz inequality in the integral yields

$$\begin{aligned} \sum_{i=1}^{\infty} \|\mathbf{K}_u |e_i\rangle\|^2 &\leq \int_G \int_G \langle \mathbf{T}_x u | \mathbf{T}_x u \rangle \langle \mathbf{T}_y u | \mathbf{T}_y u \rangle d\mu_x d\mu_y \\ &= \int_G \int_G \langle u | u \rangle \langle u | u \rangle d\mu_x d\mu_y \quad (\text{because rep. is unitary}) \\ &= \|u\|^4 \int_G d\mu_x \int_G d\mu_y = \|u\|^4 V_G^2 < \infty, \end{aligned}$$

where V_G is the *finite* volume of G . □

Historical Notes

Hermann Klaus Hugo Weyl (1885–1955) attended the gymnasium at Altona and, on the recommendation of the headmaster of his gymnasium, who was a cousin of Hilbert, decided at the age of eighteen to enter the University of Göttingen. Except for one year at Munich he remained at Göttingen, as a student and later as Privatdozent, until 1913, when he became professor at the University of Zurich. After Klein’s retirement in 1913, Weyl declined an offer to be his successor at Göttingen but accepted a second offer in 1930, after Hilbert had retired. In 1933 he decided he could no longer remain in Nazi Germany and accepted a position at the Institute for Advanced Study at Princeton, where he worked until his retirement in 1951. In the last years of his life he divided his time between Zurich and Princeton.



Hermann Klaus Hugo Weyl 1885–1955

Weyl undoubtedly was the most gifted of Hilbert’s students. Hilbert’s thought dominated the first part of his mathematical career; and although later he sharply diverged from his master, particularly on questions related to foundations of mathematics, Weyl always shared his convictions that the value of abstract theories lies in their success in solving classical problems and that the proper way to approach a question is through a deep analysis of the concepts it involves rather than by blind computations.

Weyl arrived at Göttingen during the period when Hilbert was creating the spectral theory of self-adjoint operators, and spectral theory and harmonic analysis were central in Weyl’s mathematical research throughout his life. Very soon, however, he considerably broadened the range of his interests, including areas of mathematics into which Hilbert had never penetrated, such as the theory of Lie groups and the analytic theory of numbers, thereby becoming one of the most universal mathematicians of his generation. He also had an important role in the development of mathematical physics, the field to which his most famous books, *Raum, Zeit und Materie* (1918), on the theory of relativity, and *Gruppentheorie und Quantenmechanik* (1928), are devoted.

Weyl’s versatility is illustrated in a particularly striking way by the fact that immediately after some original advances in number theory (which he obtained in 1914), he spent more than ten years as a geometer—a geometer in the most modern sense of the word, uniting in his methods topology, algebra, analysis, and geometry in a display of dazzling virtuosity and uncommon depth reminiscent of Riemann. Drawn by war mobilization into the German army, Weyl did not resume his interrupted work when he was allowed to return to civilian life in 1916. At Zurich he had worked with Einstein for one year, and he became keenly interested in the general theory of relativity, which had just been published; with his characteristic enthusiasm he devoted most of the next five years to exploring the mathematical framework of the theory. In these investigations Weyl introduced the concept of what is now called a *linear connection*, linked not to the Lorentz group of orthogonal transformations, but to the enlarged group of conformal transformations; he even thought for a time that this would give him a unified theory of gravitation and electromagnetism, the forerunner of what is now called *gauge theories*.

Weyl's use of tensor calculus in his work on relativity led him to reexamine the basic methods of that calculus and, more generally, of classical invariant theory that had been its forerunner but had fallen into near oblivion after Hilbert's work of 1890. On the other hand, his semiphilosophical, semimathematical ideas on the general concept of "space" in connection with Einstein's theory had directed his investigations to generalizations of Helmholtz's problem of characterizing Euclidean geometry by properties of "free mobility." From these two directions Weyl was brought into contact with the theory of linear representations of Lie groups; his papers on the subject (1925–1927) certainly represent his masterpiece and must be counted among the most influential works in twentieth-century mathematics.

Based on the early 1900s works of Frobenius, I. Schur, and A. Young, Weyl inaugurated a new approach for the representation of continuous groups by focusing his attention on Lie groups, rather than Lie algebras.

Very few of Weyl's 150 published books and papers—even those chiefly of an expository character—lack an original idea or a fresh viewpoint. The influence of his works and of his teaching was considerable: He proved by his example that an "abstract" approach to mathematics is perfectly compatible with "hard" analysis and, in fact, can be one of the most powerful tools when properly applied.

Weyl was one of that rare breed of modern mathematician whose contribution to physics was also substantial. In an interview with a reporter in 1929, Dirac is asked the following question: "... I want to ask you something more: They tell me that you and Einstein are the only two real sure-enough high-brows and the only ones who can really understand each other. I won't ask you if this is straight stuff, for I know you are too modest to admit it. But I want to know this—Do you ever run across a fellow that even you can't understand?" To this Dirac replies one word: "Weyl."

Weyl had a lifelong interest in philosophy and metaphysics, and his mathematical activity was seldom free from philosophical undertones or afterthoughts. At the height of the controversy over the foundations of mathematics, between the formalist school of Hilbert and the intuitionist school of Brouwer, he actively fought on Brouwer's side. His own comment, stated somewhat jokingly, sums up his personality: "My work always tried to unite the truth with the beautiful, but when I had to choose one or the other, I usually chose the beautiful."

We now come to the most fundamental theorem of representation theory of compact Lie groups. Before stating and proving this theorem, we need the following lemma:

Lemma 30.1.6 *Let $T : G \rightarrow GL(\mathcal{H})$ be an irreducible unitary representation of a compact Lie group G . For any nonzero $|u\rangle, |v\rangle \in \mathcal{H}$, we have*

$$\frac{1}{\|u\|^2 \|v\|^2} \int_G |\langle v | \mathbf{T}_x |u\rangle|^2 d\mu_x = c, \quad (30.2)$$

where $c > 0$ is a constant independent of $|u\rangle$ and $|v\rangle$.

Proof By Schur's lemma and (2) of Proposition 30.1.5, $\mathbf{K}_u = \lambda(u)\mathbf{1}$. Therefore, on the one hand,

$$\langle v | \mathbf{K}_u |v\rangle = \lambda(u) \|v\|^2. \quad (30.3)$$

On the other hand,

$$\langle v | \mathbf{K}_u |v\rangle = \int_G \langle v | \mathbf{T}_x u \rangle \langle \mathbf{T}_x u | v \rangle d\mu_x = \int_G |\langle v | \mathbf{T}_x |u\rangle|^2 d\mu_x. \quad (30.4)$$

Moreover, if we use $d\mu_g = d\mu_{g^{-1}}$ (see Problem 29.12), then

$$\begin{aligned} \langle v | \mathbf{K}_u | v \rangle &= \int_G \langle v | \mathbf{T}_x | u \rangle \langle u | \mathbf{T}_x^\dagger | v \rangle d\mu_x = \int_G \langle v | \mathbf{T}_x | u \rangle \langle u | \mathbf{T}_x^{-1} | v \rangle d\mu_x \\ &= \int_G \langle u | \mathbf{T}_{x^{-1}} | v \rangle \langle v | \mathbf{T}_x | u \rangle d\mu_x = \int_G \langle u | \mathbf{T}_y | v \rangle \langle v | \mathbf{T}_{y^{-1}} | u \rangle d\mu_{y^{-1}} \\ &= \int_G \langle u | \mathbf{T}_y | v \rangle \underbrace{\langle v | \mathbf{T}_y^\dagger | u \rangle}_{=\langle \mathbf{T}_y v | u \rangle} \underbrace{d\mu_{y^{-1}}}_{d\mu_y} = \langle u | \mathbf{K}_v | u \rangle. \end{aligned}$$

This equality plus Eq. (30.3) gives

$$\lambda(u) \|v\|^2 = \lambda(v) \|u\|^2 \Rightarrow \frac{\lambda(v)}{\|v\|^2} = \frac{\lambda(u)}{\|u\|^2}.$$

Since $|u\rangle$ and $|v\rangle$ are arbitrary, we conclude that $\lambda(u) = c\|u\|^2$ for all $|u\rangle \in \mathcal{H}$, where c is a constant. Equations (30.3) and (30.4) now yield Eq. (30.2). If we let $|u\rangle = |v\rangle$ in Eq. (30.4) and use (30.3), we obtain

$$\int_G |\langle u | \mathbf{T}_x | u \rangle|^2 d\mu_x = \lambda(u) \|u\|^2 = c \|u\|^4.$$

That $c > 0$ follows from the fact that the LHS is a nonnegative continuous function that has at least one strictly positive value in its integration range, namely at $x = e$, the identity. \square

Theorem 30.1.7 *Every irreducible unitary representation of a compact Lie group is finite-dimensional.*

Proof Let $\{|e_i\rangle\}_{i=1}^n$ be any set of orthonormal vectors in \mathcal{H} . Then, unitarity of \mathbf{T}_g implies that $\{\mathbf{T}_g |e_i\rangle\}_{i=1}^n$ is also an orthonormal set. Applying Lemma 30.1.6 to $|e_j\rangle$ and $|e_1\rangle$, we obtain

$$\int_G |\langle e_1 | \mathbf{T}_x | e_j \rangle|^2 d\mu_x = c.$$

Now sum over j to get

$$\begin{aligned} nc &= \sum_{j=1}^n \int_G |\langle e_1 | \mathbf{T}_x | e_j \rangle|^2 d\mu_x = \int_G \sum_{j=1}^n |\langle e_1 | \mathbf{T}_x | e_j \rangle|^2 d\mu_x \\ &\leq \int_G \langle e_1 | e_1 \rangle d\mu_x = V_G, \end{aligned}$$

where we used the Parseval inequality [Eq. (7.3)] as applied to the vector $|e_1\rangle$ and the orthonormal set $\{\mathbf{T}_g |e_i\rangle\}_{i=1}^n$. Since both V_G and c are finite, n must be finite as well. Thus, \mathcal{H} cannot have an infinite set of orthonormal vectors. \square

So far, we have discussed irreducible representations. What can we say about arbitrary representations? We recall that in the case of finite groups, every representation can be written as a direct sum of irreducible representations. Is this also true for compact Lie groups?

Firstly, we note that the Weyl operator, being Hilbert-Schmidt, is necessarily compact. It is also hermitian. Therefore, by the spectral theorem, its eigenspaces span the carrier space \mathcal{H} . Specifically, we can write $\mathcal{H} = \mathcal{M}_0 \oplus \sum_{j=1}^N \mathcal{M}_j$, where \mathcal{M}_0 is the eigenspace corresponding to the zero eigenvalue of \mathbf{K}_u , and N could be infinity.

Secondly, from the relation $\langle v | \mathbf{K}_u | v \rangle = c \|u\|^2 \|v\|^2$ and the fact that $c \neq 0$ and $|u\rangle \neq 0$, we conclude that \mathbf{K}_u cannot have any nonzero eigenvector for its zero eigenvalue. It follows that \mathcal{M}_0 contains only the zero vector. Therefore, if \mathcal{H} is infinite-dimensional, then $N = \infty$.

Thirdly, consider any representation T of G . Because \mathbf{K}_u commutes with all \mathbf{T}_g , each eigenspace of \mathbf{K}_u is an invariant subspace under T . If a subspace \mathcal{U} is invariant under T , then $\mathcal{U} \cap \mathcal{M}_j$, a subspace of \mathcal{M}_j , is also invariant (reader, please verify!). Thus, all invariant subspaces of G are reducible to invariant subspaces of eigenspaces of \mathbf{K}_u . In particular, all irreducible invariant subspaces of T are subspaces of eigenspaces of \mathbf{K}_u .

Lastly, since all \mathcal{M}_j are finite-dimensional, we can use the procedure used in the case of finite groups and decompose \mathcal{M}_j into irreducible invariant subspaces of T . We have just shown the following result:

Theorem 30.1.8 *Every unitary representation T of a compact Lie group G is a direct sum of irreducible finite-dimensional unitary representations.*

By choosing a basis for the finite-dimensional invariant subspaces of T , we can represent each \mathbf{T}_g by a matrix. Therefore,

Box 30.1.9 *Compact Lie groups can be represented by matrices.*

As in the case of finite groups, one can work with matrix elements and characters of representations. The only difference is that summations are replaced with integration and order of the group $|G|$ is replaced with V_G , which we take to be unity.¹ For example, Eq. (24.6) becomes

$$\int_G T^{(\alpha)}(g) \mathbf{X} T^{(\beta)}(g^{-1}) d\boldsymbol{\mu}_g = \lambda_X \delta_{\alpha\beta} \mathbf{1}, \quad (30.5)$$

and the analogue of Eq. (24.8) is

$$\int_G T_{il}^{(\alpha)}(g) T_{jm}^{(\beta)*}(g) d\boldsymbol{\mu}_g = \frac{1}{n_\alpha} \delta_{ml} \delta_{\alpha\beta} \delta_{ij}. \quad (30.6)$$

¹This can always be done by rescaling the volume element.

Characters satisfy similar relations: Eq. (24.11) becomes

$$\int_G \chi^{(\alpha)}(g) \chi^{(\beta)*}(g) d\mu_g = \delta_{\alpha\beta}, \tag{30.7}$$

and the useful Eq. (24.16) turns into

$$\int_G |\chi(g)|^2 d\mu_g = \sum_{\alpha} m_{\alpha}^2. \tag{30.8}$$

This formula can be used to test for irreducibility of a representation: If the integral is unity, the representation is irreducible; otherwise, it is reducible.

Finally, we state the celebrated **Peter-Weyl** theorem (for a proof, see [Baru 86, pp. 172–173])

Peter-Weyl theorem

Theorem 30.1.10 (Peter-Weyl theorem) *The functions*

$$\sqrt{n_{\alpha}} T_{ij}^{(\alpha)}(g), \quad \forall \alpha \quad \text{and} \quad 1 \leq i, j \leq n_{\alpha},$$

form a complete set of functions in $\mathcal{L}^2(G)$, the Hilbert space of square-integrable functions on G .

If $u \in \mathcal{L}^2(G)$, we can write

$$u(g) = \sum_{\alpha} \sum_{i,j} b_{ij}^{\alpha} T_{ij}^{(\alpha)}(g) \quad \text{where} \quad b_{ij}^{\alpha} = n_{\alpha} \int_G u(g) T_{ij}^{(\alpha)*}(g) d\mu_g. \tag{30.9}$$

Example 30.1.11 Equation (30.9) is the generalization of the Fourier series expansion of functions. The connection with Fourier series becomes more transparent if we consider a particular compact group. The unit circle S^1 is a one-dimensional abelian compact 1-parameter Lie group. In fact, fixing an “origin” on the circle, any other point can be described by the parameter θ , the angular distance from the point to the origin. S^1 is obviously abelian; it is also compact, because it is a bounded closed region of \mathbb{R}^2 (BWHB theorem). By Theorem 24.3.3, which holds for all Lie groups, all irreducible representations of S^1 are 1-dimensional. So $T_{ij}^{(\alpha)}(g) \rightarrow T^{(\alpha)}(\theta)$. Furthermore, $T^{(\alpha)}(\theta)T^{(\alpha)}(\theta') = T^{(\alpha)}(\theta + \theta')$. Differentiating both sides with respect to θ' at $\theta' = 0$ yields the differential equation

The Peter-Weyl theorem is the generalization of the Fourier series expansion of periodic functions.

$$T^{(\alpha)}(\theta) \underbrace{\frac{dT^{(\alpha)}}{d\theta'} \Big|_{\theta'=0}}_{\equiv a} = \frac{dT^{(\alpha)}}{dy} \Big|_{y=\theta} \equiv \frac{dT^{(\alpha)}}{d\theta}, \quad y \equiv \theta + \theta'.$$

The solution to this DE is $Ae^{a\theta}$. Since $T^{(\alpha)}$ are unitary, and since a 1-dimensional unitary matrix must look like $e^{i\varphi}$, we must have $A = 1$. Furthermore, θ and $\theta + 2\pi$ are identified on the unit circle; therefore, we must

conclude that a is i times an integer n , which determines the irreducible representation. We label the irreducible representation by n and write

$$T^{(n)}(\theta) = e^{in\theta}, \quad n = 0 \pm 1 \pm 2 \dots$$

The Peter-Weyl theorem now becomes the rule of Fourier series expansion of *periodic functions*. This last property follows from the fact that any function $u : S^1 \rightarrow \mathbb{R}$ is necessarily periodic.

There are many occasions in physics where the state functions describing physical quantities transform irreducibly under the action of a Lie group (which we assume to be compact). Often this Lie group also acts on the underlying space-time manifold. So we have a situation in which a Lie group G acts on a Euclidean space \mathbb{R}^n as well as on the space of (square-integrable) functions $\mathcal{L}(\mathbb{R}^n)$. Therefore, the functions $\{\phi_i^{(\alpha)}(\mathbf{x})\}$, belonging to the α th irreducible representation transform among themselves not only because of the index i , but also because of the argument $\mathbf{x} \in \mathbb{R}^n$.

To see the connection between physics and representation theory, consider the transformation of the simplest case, a scalar function. As a concrete example, choose temperature. To observer O at the corner of a room 8 meters long, 6 meters wide, and 3 meters high, the temperature of the center of the room is given by $\theta(4, 3, 1.5)$ where $\theta(x, y, z)$ is a function that gives O the temperature of various points of the room. Observer O' is sitting in the middle of the floor, so that the center of the room has coordinates $(0, 0, 1.5)$. O' also has a function that gives her the temperature at various points. But this function must necessarily be different from θ because of the different coordinates the same points have for O and O' . Calling this function θ' , we have $\theta'(0, 0, 1.5) = \theta(4, 3, 1.5)$, and in general,

$$\theta'(x', y', z') = \theta(x, y, z),$$

where (x', y', z') describes the same point for O' that (x, y, z) describes for O .

In the context of representation theory, we can think of (x', y', z') as the transformed coordinates obtained as a result of the action of some group: $(x', y', z') = g \cdot (x, y, z)$, or $\mathbf{x}' = g \cdot \mathbf{x}$. So, the equation above can be written as

$$\theta'(\mathbf{x}') = \theta(\mathbf{x}) = \theta(g^{-1} \cdot \mathbf{x}') \quad \text{or} \quad \theta'(\mathbf{x}) = \theta(g^{-1} \cdot \mathbf{x}).$$

It is natural to call θ' the transform of θ under the action of g and write $\theta' = \mathbf{T}_g \theta$. This is one way of constructing a representation [see the comments after Eq. (24.1)]. Instead of g^{-1} on the left, one could act with g on the right.

When the physical quantity is not a scalar, it is natural to group together the smallest set of functions that transform into one another. This leads to the set of functions that transform according to a row of an irreducible representation of the group. In some sense, this situation is a combination of

(24.1) and (24.35). The reader may verify that

$$\mathbf{T}_g \phi_i^{(\alpha)}(\mathbf{x}) = \sum_{j=1}^{n_\alpha} T_{ji}^{(\alpha)}(g) \phi_j^{(\alpha)}(\mathbf{x} \cdot g^{-1}) \quad (30.10)$$

defines a representation of G .

We now use Box 29.1.31 to construct an irreducible representation of the Lie algebra of G from Eq. (30.10). By the definition of the infinitesimal action, we let $g = \exp(\xi t)$ and differentiate both sides with respect to t at $t = 0$. This yields

$$\begin{aligned} \underbrace{\frac{d}{dt} \mathbf{T}_{\exp(\xi t)} \phi_i^{(\alpha)}(\mathbf{x}) \Big|_{t=0}}_{\equiv \sum_j \mathfrak{D}_{ji}(\xi) \phi_j^{(\alpha)}(\mathbf{x})} &= \sum_{j=1}^{n_\alpha} \frac{d}{dt} \left\{ T_{ji}^{(\alpha)}(\exp(\xi t)) \phi_j^{(\alpha)}(\mathbf{x} \cdot \exp(-\xi t)) \right\} \Big|_{t=0} \\ &= \sum_{j=1}^{n_\alpha} \frac{d}{dt} T_{ji}^{(\alpha)}(\exp(\xi t)) \Big|_{t=0} \underbrace{\phi_j^{(\alpha)}(\mathbf{x} \cdot \exp(-\xi 0))}_{=\mathbf{x}} \\ &\quad + \sum_{j=1}^{n_\alpha} \underbrace{T_{ji}^{(\alpha)}(\exp(\xi 0))}_{=\delta_{ji}} \frac{d}{dt} \phi_j^{(\alpha)}(\mathbf{x} \cdot \exp(-\xi t)) \Big|_{t=0}, \end{aligned}$$

where we have defined the matrices $\mathfrak{D}_{ji}(\xi)$ for the LHS. The derivative in the first sum is simply $\mathfrak{T}_{ji}^{(\alpha)}(\xi)$ the representation of the generator ξ of the 1-parameter group of transformations in the space of functions $\{\phi_i^{(\alpha)}\}$. The derivative in the second sum can be found by writing $\mathbf{x}'(t) = \mathbf{x} \cdot \exp(-\xi t)$ and differentiating as follows:

$$\begin{aligned} \frac{d}{dt} \phi_j^{(\alpha)}(\mathbf{x}'(t)) \Big|_{t=0} &\equiv \frac{d}{dt} \phi_j^{(\alpha)}(x'^1(t), \dots, x'^n(t)) \Big|_{t=0} = \partial_k \phi_j^{(\alpha)} \frac{d}{dt} (x'^k(t)) \Big|_{t=0} \\ &= \partial_k \phi_j^{(\alpha)} u_\mu^k(\mathbf{x}) \frac{da^\mu}{dt} \equiv \partial_k \phi_j^{(\alpha)} X^k(\mathbf{x}; \xi) \equiv \partial_\nu \phi_j^{(\alpha)} X^\nu(\mathbf{x}; \xi), \end{aligned}$$

where we used Eq. (29.23) and defined $X^k(\mathbf{x}; \xi)$ by the last equality. We also changed the coordinate index to Greek to avoid confusing it with the index of the functions. Collecting everything together, we obtain

$$\sum_{j=1}^{n_\alpha} \mathfrak{D}_{ij}(\xi) \phi_j^{(\alpha)}(\mathbf{x}) = \sum_{j=1}^{n_\alpha} \mathfrak{T}_{ij}^{(\alpha)}(\xi) \phi_j^{(\alpha)}(\mathbf{x}) + \sum_{j=1}^{n_\alpha} \delta_{ij} X^\nu(\mathbf{x}; \xi) \frac{\partial \phi_j^{(\alpha)}}{\partial x^\nu},$$

or, since $\phi_j^{(\alpha)} = \sum_k \phi_k^{(\alpha)} (\partial / \partial \phi_k^{(\alpha)}) \phi_j^{(\alpha)}$,

$$\mathfrak{D}_{ij}(\xi) = \mathfrak{T}_{ij}^{(\alpha)}(\xi) \phi_k^{(\alpha)}(\mathbf{x}) \frac{\partial}{\partial \phi_k^{(\alpha)}} + \delta_{ij} X^\nu(\mathbf{x}; \xi) \frac{\partial}{\partial x^\nu}, \quad (30.11)$$

where $X^\nu(\mathbf{x}; \xi)$ is the ν th component of the infinitesimal generator of the action induced by $\xi \in \mathfrak{g}$. We shall put Eq. (30.11) to good use when we discuss symmetries and conservation laws in Chap. 33. The derivative with respect

to the functions, although meaningless at this point, will be necessary when we discuss conservation laws.

30.2 Representation of the General Linear Group

$GL(\mathcal{V})$ is not a compact group, but we can use the experience we gained in the analysis of the symmetric group to find the irreducible representations of $GL(\mathcal{V})$. The key is to construct tensor product spaces of \mathcal{V} —which, as the reader may verify, is a carrier space of $GL(\mathcal{V})$ —and look for its irreducible subspaces. In fact, if r is an arbitrary positive integer, $T : G \rightarrow GL(\mathcal{V})$ is a representation, and

$$\mathcal{V}^{\otimes r} \equiv \underbrace{\mathcal{V} \otimes \cdots \otimes \mathcal{V}}_{r \text{ times}},$$

then $T^{\otimes r} : G \rightarrow GL(\mathcal{V}^{\otimes r})$, given by

$$[T^{\otimes r}(g)](\mathbf{v}_1, \dots, \mathbf{v}_r) \equiv \mathbf{T}_g^{\otimes r}(\mathbf{v}_1, \dots, \mathbf{v}_r) = \mathbf{T}_g(\mathbf{v}_1) \otimes \cdots \otimes \mathbf{T}_g(\mathbf{v}_r),$$

is also a representation. In particular, considering \mathcal{V} as the (natural) carrier space for $GL(\mathcal{V})$, we conclude that $T^{\otimes r} : GL(\mathcal{V}) \rightarrow GL(\mathcal{V}^{\otimes r})$ is a representation.

This tensor product representation is reducible, because as is evident from its definition, $\mathbf{T}_g^{\otimes r}$ preserves any symmetry of the tensor it acts on. For example, the subspace of the full n^r -dimensional tensor product space—with n being the dimension of \mathcal{V} —consisting of the completely symmetric tensors of the type

$$\mathbf{t}_s \equiv \sum_{\pi \in S_r} \mathbf{v}_{\pi(1)} \otimes \mathbf{v}_{\pi(2)} \otimes \cdots \otimes \mathbf{v}_{\pi(r)}$$

is invariant. Similarly, the subspace consisting of the completely antisymmetric tensor products—the r -fold wedge products—is invariant.

To reduce $\mathcal{V}^{\otimes r}$, we choose a basis $\{\mathbf{e}_k\}_{k=1}^n$ for \mathcal{V} . Then the collection of n^r tensor products $\{\mathbf{e}_{k_1} \otimes \cdots \otimes \mathbf{e}_{k_r}\}$, where each k_i runs from 1 to n , is a basis for $\mathcal{V}^{\otimes r}$. An invariant subspace of $\mathcal{V}^{\otimes r}$ is a span of linear combinations of certain of these basis vectors. Since the only thing that distinguishes among $\{\mathbf{e}_{k_1} \otimes \cdots \otimes \mathbf{e}_{k_r}\}$ is a permutation of the r labels, we start to see the connection between the reduction of $\mathcal{V}^{\otimes r}$ and S_r . This connection becomes more evident if we recall that the left multiplication of the group algebra of S_r by its elements provides the regular representation, which is reducible. The irreducible representations are the minimal ideals of the algebra generated by the Young operators.

The same idea works here as well: Certain linear combination of the basis vectors of $\mathcal{V}^{\otimes r}$ obtained by permutations can serve as the basis vectors for irreducible representations of $GL(\mathcal{V})$. Let us elaborate on this. Recall that a Young operator of S_r is written in the form $Y = QP$ where Q and P are linear combinations of permutations in S_r . Y has the property that if one operates on it (via left multiplication) with all permutations of S_r , one

connection between the Young tableaux and irreducible representations of $GL(\mathcal{V})$

generates a minimal ideal, i.e., an *irreducible representation* of S_r . Now let \mathbf{Y} be a Young operator that acts on the indices (k_1, \dots, k_r) , giving linear combinations of the basis vectors of $\mathcal{V}^{\otimes r}$. From the minimality of the ideal generated by Y and the fact that operators in $GL(\mathcal{V})$ permute the factors in $\mathbf{e}_{k_1} \otimes \dots \otimes \mathbf{e}_{k_r}$ in all possible ways, it should now be clear that if we choose any *single* basis vector $\mathbf{e}_{k_1} \otimes \dots \otimes \mathbf{e}_{k_r}$, then $\mathbf{Y}(\mathbf{e}_{k_1} \otimes \dots \otimes \mathbf{e}_{k_r})$ generates an irreducible representation of $GL(\mathcal{V})$. We therefore have the following:

Theorem 30.2.1 *Let $\{\mathbf{e}_k\}_{k=1}^n$ be any basis for \mathcal{V} . Let $\mathbf{Y} = \mathbf{QP}$ be the Young operator of S_r that permutes (and takes linear combinations of) the basis vectors $\{\mathbf{e}_{k_1} \otimes \dots \otimes \mathbf{e}_{k_r}\}$. Then for any given such basis vector, the vectors*

$$\{\mathbf{T}_g^{\otimes r} \mathbf{Y}(\mathbf{e}_{k_1} \otimes \dots \otimes \mathbf{e}_{k_r}) \mid g \in GL(\mathcal{V})\}$$

span an irreducible subspace of $\mathcal{V}^{\otimes r}$.

A basis of such an irreducible representation can be obtained by taking into account all the Young tableaux associated with the irreducible representation. But which of the symmetry types will be realized for given values of n and r ? Clearly, the Young tableau should not contain more than n rows, because then one of the symbols will be repeated in a column, and the Young operator will vanish due to the antisymmetry in its column indices. We can therefore restrict the partition (λ) to

$$(\lambda) = (\lambda_1, \lambda_2, \dots, \lambda_n), \quad \lambda_1 + \dots + \lambda_n = r, \quad \lambda_1 \geq \lambda_2 \geq \dots \geq \lambda_n \geq 0.$$

Let us consider an example for clarification.

Example 30.2.2 First, let $n = r = 2$. The tensor product space has $2^2 = 4$ dimensions. To reduce it, we consider the Young operators, which correspond to $e + (k_1, k_2)$ and $e - (k_1, k_2)$. Let us denote these operators by \mathbf{Y}_1 and \mathbf{Y}_2 , respectively. By applying each one to a generic basis vector $\mathbf{e}_{k_1} \otimes \mathbf{e}_{k_2}$, we can generate all the irreducible representations. The first operator gives

$$\mathbf{Y}_1(\mathbf{e}_{k_1} \otimes \mathbf{e}_{k_2}) = \mathbf{e}_{k_1} \otimes \mathbf{e}_{k_2} + \mathbf{e}_{k_2} \otimes \mathbf{e}_{k_1},$$

where k_1 and k_2 can be 1 or 2. For $k_1 = k_2 = 1$, we get $2\mathbf{e}_1 \otimes \mathbf{e}_1$. For $k_1 = 1, k_2 = 2$, or $k_1 = 2, k_2 = 1$, we get $\mathbf{e}_1 \otimes \mathbf{e}_2 + \mathbf{e}_2 \otimes \mathbf{e}_1$. Finally, for $k_1 = k_2 = 2$, we get $2\mathbf{e}_2 \otimes \mathbf{e}_2$. Altogether, we obtain 3 linearly independent vectors that are completely symmetric.

When the second operator acts on a generic basis vector, it gives

$$\mathbf{Y}_2(\mathbf{e}_{k_1} \otimes \mathbf{e}_{k_2}) = \mathbf{e}_{k_1} \otimes \mathbf{e}_{k_2} - \mathbf{e}_{k_2} \otimes \mathbf{e}_{k_1}.$$

The only time that this is not zero is when k_1 and k_2 are different. In either case, we get $\pm(\mathbf{e}_1 \otimes \mathbf{e}_2 - \mathbf{e}_2 \otimes \mathbf{e}_1)$. This subspace is therefore one-dimensional.

The reduction of the tensor product space can therefore be written as

$$\mathcal{V}^{\otimes 2} = \underbrace{\text{Span}\{\mathbf{e}_1 \otimes \mathbf{e}_1, \mathbf{e}_1 \otimes \mathbf{e}_2 + \mathbf{e}_2 \otimes \mathbf{e}_1, \mathbf{e}_2 \otimes \mathbf{e}_2\}}_{\text{3D symmetric subspace}} \oplus \underbrace{\text{Span}\{\mathbf{e}_1 \otimes \mathbf{e}_2 - \mathbf{e}_2 \otimes \mathbf{e}_1\}}_{\text{1D antisymmetric subspace}}.$$

Next, let us consider the case of $n = 2, r = 3$. The tensor product space has $2^3 = 8$ dimensions. To reduce it, we need to consider all Young operators of S_3 . There are four of these, corresponding to the following tableaux:

$$\begin{array}{|c|c|c|} \hline k_1 & k_2 & k_3 \\ \hline \end{array} \quad \begin{array}{|c|c|} \hline k_1 & k_2 \\ \hline k_3 \\ \hline \end{array} \quad \begin{array}{|c|c|} \hline k_1 & k_3 \\ \hline k_2 \\ \hline \end{array} \quad \begin{array}{|c|} \hline k_1 \\ \hline k_2 \\ \hline k_3 \\ \hline \end{array}$$

Let us denote these operators by $\mathbf{Y}_1, \mathbf{Y}_2, \mathbf{Y}_3,$ and $\mathbf{Y}_4,$ respectively. By applying each one to a generic basis vector $\mathbf{e}_{k_1} \otimes \mathbf{e}_{k_2} \otimes \mathbf{e}_{k_3},$ we can generate all the irreducible representations. The first operator gives

$$\begin{aligned} \mathbf{Y}_1(\mathbf{e}_{k_1} \otimes \mathbf{e}_{k_2} \otimes \mathbf{e}_{k_3}) &= \mathbf{e}_{k_1} \otimes \mathbf{e}_{k_2} \otimes \mathbf{e}_{k_3} + \mathbf{e}_{k_1} \otimes \mathbf{e}_{k_3} \otimes \mathbf{e}_{k_2} + \mathbf{e}_{k_2} \otimes \mathbf{e}_{k_1} \otimes \mathbf{e}_{k_3} \\ &\quad + \mathbf{e}_{k_2} \otimes \mathbf{e}_{k_3} \otimes \mathbf{e}_{k_1} + \mathbf{e}_{k_3} \otimes \mathbf{e}_{k_1} \otimes \mathbf{e}_{k_2} \\ &\quad + \mathbf{e}_{k_3} \otimes \mathbf{e}_{k_2} \otimes \mathbf{e}_{k_1}, \end{aligned}$$

where $k_1, k_2,$ and k_3 can be 1 or 2. For $k_1 = k_2 = k_3 = 1,$ we get $6\mathbf{e}_1 \otimes \mathbf{e}_1 \otimes \mathbf{e}_1.$ For the case where two of the k_i 's are 1 and the third is 2, we get

$$2(\mathbf{e}_1 \otimes \mathbf{e}_1 \otimes \mathbf{e}_2 + \mathbf{e}_1 \otimes \mathbf{e}_2 \otimes \mathbf{e}_1 + \mathbf{e}_2 \otimes \mathbf{e}_1 \otimes \mathbf{e}_1).$$

For the case where two of the k_i 's are 2 and the third is 1, we get

$$2(\mathbf{e}_1 \otimes \mathbf{e}_2 \otimes \mathbf{e}_2 + \mathbf{e}_2 \otimes \mathbf{e}_1 \otimes \mathbf{e}_2 + \mathbf{e}_2 \otimes \mathbf{e}_2 \otimes \mathbf{e}_1).$$

Finally, for $k_1 = k_2 = k_3 = 2,$ we get $6\mathbf{e}_2 \otimes \mathbf{e}_2 \otimes \mathbf{e}_2.$ Altogether, we obtain 4 linearly independent vectors that are completely symmetric.

When the second operator acts on a generic basis vector, it gives²

$$\begin{aligned} \mathbf{Y}_2(\mathbf{e}_{k_1} \otimes \mathbf{e}_{k_2} \otimes \mathbf{e}_{k_3}) &= [e - (k_1, k_3)][e + (k_1, k_2)](\mathbf{e}_{k_1} \otimes \mathbf{e}_{k_2} \otimes \mathbf{e}_{k_3}) \\ &= \mathbf{e}_{k_1} \otimes \mathbf{e}_{k_2} \otimes \mathbf{e}_{k_3} + \mathbf{e}_{k_2} \otimes \mathbf{e}_{k_1} \otimes \mathbf{e}_{k_3} \\ &\quad - \mathbf{e}_{k_3} \otimes \mathbf{e}_{k_2} \otimes \mathbf{e}_{k_1} - \mathbf{e}_{k_2} \otimes \mathbf{e}_{k_3} \otimes \mathbf{e}_{k_1}. \end{aligned}$$

If all three indices are the same, we get zero. Suppose $k_1 = 1.$ Then k_2 can be 1 or 2. For $k_2 = 1,$ we must set $k_3 = 2$ to get $\mathbf{e}_2 \otimes \mathbf{e}_1 \otimes \mathbf{e}_1 - \mathbf{e}_1 \otimes \mathbf{e}_2 \otimes \mathbf{e}_1.$ For $k_2 = 2,$ we must set $k_3 = 1$ to obtain $\mathbf{e}_1 \otimes \mathbf{e}_2 \otimes \mathbf{e}_2 - \mathbf{e}_2 \otimes \mathbf{e}_1 \otimes \mathbf{e}_2.$ If we

²When a symmetric group is considered as an abstract group—as opposed to a group of transformations—we may multiply permutations (keep track of how each number is repeatedly transformed) from left to right. However, since the permutations here act on vectors on their right, it is more natural to calculate their products from right to left.

start with $k_1 = 2$, we will not produce any new vectors, as the reader is urged to verify. Therefore, the dimension of the irreducible subspace spanned by the second Young tableau is 2.

The action of the third operator on a generic basis vector yields

$$\begin{aligned} \mathbf{Y}_3(\mathbf{e}_{k_1} \otimes \mathbf{e}_{k_2} \otimes \mathbf{e}_{k_3}) &= [e - (k_1, k_2)][e + (k_1, k_3)](\mathbf{e}_{k_1} \otimes \mathbf{e}_{k_2} \otimes \mathbf{e}_{k_3}) \\ &= \mathbf{e}_{k_1} \otimes \mathbf{e}_{k_2} \otimes \mathbf{e}_{k_3} + \mathbf{e}_{k_2} \otimes \mathbf{e}_{k_1} \otimes \mathbf{e}_{k_3} \\ &\quad - \mathbf{e}_{k_3} \otimes \mathbf{e}_{k_2} \otimes \mathbf{e}_{k_1} - \mathbf{e}_{k_3} \otimes \mathbf{e}_{k_1} \otimes \mathbf{e}_{k_2}. \end{aligned}$$

The reader may check that we obtain a two-dimensional irreducible representation spanned by $\mathbf{e}_1 \otimes \mathbf{e}_1 \otimes \mathbf{e}_2 - \mathbf{e}_2 \otimes \mathbf{e}_1 \otimes \mathbf{e}_1$ and $\mathbf{e}_1 \otimes \mathbf{e}_2 \otimes \mathbf{e}_2 - \mathbf{e}_2 \otimes \mathbf{e}_2 \otimes \mathbf{e}_1$.

The fourth Young operator gives zero because it is completely antisymmetric in three slots and we have only two indices. The reduction of the tensor product space can therefore be written as

$$\begin{aligned} \mathcal{V}^{\otimes 3} &= \underbrace{\text{Span}\{\mathbf{Y}_1(\mathbf{e}_{k_1} \otimes \mathbf{e}_{k_2} \otimes \mathbf{e}_{k_3})\}}_{\text{dim}=4} \oplus \underbrace{\text{Span}\{\mathbf{Y}_2(\mathbf{e}_{k_1} \otimes \mathbf{e}_{k_2} \otimes \mathbf{e}_{k_3})\}}_{\text{dim}=2} \\ &\quad \oplus \underbrace{\text{Span}\{\mathbf{Y}_3(\mathbf{e}_{k_1} \otimes \mathbf{e}_{k_2} \otimes \mathbf{e}_{k_3})\}}_{\text{dim}=2}. \end{aligned}$$

We note that the total dimensions on both sides match.

There is a remarkable formula that gives the dimension of all irreducible representations of $GL(\mathcal{V})$ (see [Hame 89, pp. 384–387] for a derivation):

Theorem 30.2.3 *Let \mathcal{V} be an n -dimensional vector space, and $\mathcal{V}^{(\lambda)}$, the irreducible subspace of tensors with symmetry associated with the partition $(\lambda) = (\lambda_1, \dots, \lambda_n)$. Then*

$$\dim \mathcal{V}^{(\lambda)} = \frac{D(l_1, \dots, l_n)}{D(n-1, n-2, \dots, 0)},$$

where $l_j \equiv \lambda_j + n - j$ and $D(x_1, \dots, x_n)$ is as given in Eq. (25.3).

30.3 Representation of Lie Algebras

The diffeomorphism established by the exponential map (Theorem 29.1.21) reduces the *local* study of a Lie group to that of its Lie algebra.³ In this book, we are exclusively interested in the local properties of Lie groups, and we

³We use the word “local” to mean the collection of all points that can be connected to the identity by a curve in the Lie group G . If this collection exhausts G , then we say that G is **connected**. If, furthermore, all closed curves (loops) in G can be shrunk to a point, we say that G is **simply connected**. The word “local” can be replaced by “simply connected” in what follows.

shall therefore confine ourselves to Lie algebras to study the structure of Lie groups. Recall that any Lie group homomorphism leads to a corresponding Lie algebra homomorphism [Eq. (29.7)]. Conversely, a homomorphism of Lie algebras can, through the identification of the neighborhoods of their identities with their Lie algebras, be “exponentiated” to a (local) homomorphism of their Lie groups. This leads to the following theorem (see [Fult 91, pp. 108 and 119] for a proof).

Theorem 30.3.1 *Let G be a Lie group with algebra \mathfrak{g} . A representation $T : G \rightarrow GL(\mathcal{H})$ determines a Lie algebra representation $T_* : \mathfrak{g} \rightarrow \mathfrak{gl}(\mathcal{H})$. Conversely, a Lie algebra representation $\mathfrak{T} : \mathfrak{g} \rightarrow \mathfrak{gl}(\mathcal{H})$ determines a Lie group representation.*

It follows from this theorem that all (local) Lie group representations result from corresponding Lie algebra representations. Therefore, we shall restrict ourselves to the representations of Lie algebras.

30.3.1 Representation of Subgroups of $GL(\mathcal{V})$

Let \mathfrak{g} be any Lie algebra with basis vectors $\{\mathbf{X}_i\}$. Let a representation T map these vectors to $\{\mathbf{T}_i\} \in \mathfrak{gl}(\mathcal{H})$ for some carrier space \mathcal{H} . Then, a general element $\mathbf{X} = \sum_i \alpha_i \mathbf{X}_i$ of \mathfrak{g} will be mapped to $\mathbf{T} = \sum_i \alpha_i \mathbf{T}_i$. Now suppose that \mathfrak{h} is a subalgebra of \mathfrak{g} . Then the restriction of T to \mathfrak{h} provides a representation of \mathfrak{h} . This restriction may be reducible. If it is, then there is an invariant subspace \mathcal{H}_1 of \mathcal{H} . It follows that

$$\langle b | \mathbf{T}_{\mathbf{X}} | a \rangle = 0 \quad \forall \mathbf{X} \in \mathfrak{h} \quad \text{whenever } |a\rangle \in \mathcal{H}_1 \text{ and } |b\rangle \in \mathcal{H}_1^\perp,$$

where $\mathbf{T}_{\mathbf{X}} \equiv T(\mathbf{X})$. If we write $\mathbf{T}_{\mathbf{X}} = \sum_i \alpha_i^{(\mathbf{X})} \mathbf{T}_i$, then in terms of \mathbf{T}_i , the equation above can be written as

$$\sum_{i=1}^{\dim \mathfrak{g}} \alpha_i^{(\mathbf{X})} \langle b | \mathbf{T}_i | a \rangle \equiv \sum_{i=1}^{\dim \mathfrak{g}} \alpha_i^{(\mathbf{X})} \tau_i^{(ba)} = 0 \quad \forall \mathbf{X} \in \mathfrak{h}, \quad (30.12)$$

where $\tau_i^{(ba)} \equiv \langle b | \mathbf{T}_i | a \rangle$ are complex numbers. Equation (30.12) states that

Box 30.3.2 *If T , as a representation of \mathfrak{h} (a Lie subalgebra of \mathfrak{g}), is reducible, then there exist a number of equations that $\alpha_i^{(\mathbf{X})}$ must satisfy whenever $\mathbf{X} \in \mathfrak{h}$. If T , as a representation of \mathfrak{g} , is irreducible, then no relation such as given in (30.12) will exist when \mathbf{X} runs over all of \mathfrak{g} .*

This last statement will be used to analyze certain subgroups of $GL(\mathcal{V})$.

Let us first identify $GL(\mathcal{V})$ with $GL(n, \mathbb{C})$. Next, consider $GL(n, \mathbb{R})$, which is a subgroup of $GL(n, \mathbb{C})$, and transfer the discussion to their respective algebras. If $\{\mathbf{X}_i\}$ is a basis of $\mathfrak{gl}(n, \mathbb{C})$, then an arbitrary element can be written as $\sum_i \alpha_i \mathbf{X}_i$. The difference between $\mathfrak{gl}(n, \mathbb{C})$ and $\mathfrak{gl}(n, \mathbb{R})$ is that the α_i 's are *real* in the latter case; i.e., for *all* real values of $\{\alpha_i\}$, the sum belongs to $\mathfrak{gl}(n, \mathbb{R})$. Now suppose that T is an irreducible representation of $\mathfrak{gl}(n, \mathbb{C})$ that is reducible when restricted to $\mathfrak{gl}(n, \mathbb{R})$. Equation (30.12) states that the function

$$f(z_1, \dots, z_{n^2}) \equiv \sum_{i=1}^{n^2} z_i \tau_i^{(ba)}$$

vanishes for *all* real values of the z_i 's. Since this function is obviously entire, it must vanish for all *complex* values of z_i 's by analytic continuation (see Theorem 12.3.1). But this is impossible because T is irreducible for $\mathfrak{gl}(n, \mathbb{C})$. We have to conclude that T is irreducible as a representation of $\mathfrak{gl}(n, \mathbb{R})$.

The next subalgebra of $\mathfrak{gl}(n, \mathbb{C})$ we consider is the Lie algebra $\mathfrak{sl}(n, \mathbb{C})$ of the special linear group. The only restriction on the elements of $\mathfrak{sl}(n, \mathbb{C})$ is for them to have a vanishing trace. Denoting $\text{tr} \mathbf{X}_i$ by t_i , we conclude that $\mathbf{X} = \sum_i \alpha_i \mathbf{X}_i$ belongs to $\mathfrak{sl}(n, \mathbb{C})$ if and only if $\sum_i \alpha_i t_i = 0$. Let $(t_1^*, \dots, t_{n^2}^*) \equiv |t\rangle \in \mathbb{C}^{n^2}$. Then $\mathfrak{sl}(n, \mathbb{C})$ can be characterized as the subspace consisting of vectors $|a\rangle \in \mathbb{C}^{n^2}$ such that $\langle a|t\rangle = 0$. Such a subspace has $n^2 - 1$ dimensions. If any irreducible representation of $\mathfrak{gl}(n, \mathbb{C})$ is reducible for $\mathfrak{sl}(n, \mathbb{C})$, then the set of complex numbers $\{\alpha_i\}$ must, in addition, satisfy Eq. (30.12). This amounts to the condition that $|a\rangle$ be orthogonal to $|\tau^{(ba)}\rangle$ as well. But this is impossible, because then the set $\{|a\rangle, |t\rangle, |\tau^{(ba)}\rangle\}$ would constitute a subspace of \mathbb{C}^{n^2} whose dimension is at least $n^2 + 1$: There are $n^2 - 1$ of $|a\rangle$'s, one $|t\rangle$, and at least one $|\tau^{(ba)}\rangle$. Therefore, all irreducible representations of $\mathfrak{gl}(n, \mathbb{C})$ are also irreducible representations of $\mathfrak{sl}(n, \mathbb{C})$.

The last subalgebra of $\mathfrak{gl}(n, \mathbb{C})$ we consider is the Lie algebra $\mathfrak{u}(n)$ of the unitary group. To study this algebra, we start with the Weyl basis of Eq. (29.32) for $\mathfrak{gl}(n, \mathbb{C})$, and construct a new *hermitian* basis $\{\mathbf{X}_{kj}\}$ defined as

$$\begin{aligned} \mathbf{X}_{jj} &\equiv \mathbf{e}_{jj} && \text{for all } j = 1, 2, \dots, n, \\ \mathbf{X}_{kj} &\equiv i(\mathbf{e}_{kj} - \mathbf{e}_{kj}^t) && \text{if } k \neq j. \end{aligned}$$

A typical element of $\mathfrak{gl}(n, \mathbb{C})$ is of the form $\sum_{kj} \alpha_{kj} \mathbf{X}_{kj}$, where α_{kj} are complex numbers. If we restrict ourselves to *real* values of α_{kj} , then we obtain the subalgebra of hermitian matrices whose Lie group is the unitary group $U(n)$. The fact that the irreducible representations of $\mathfrak{gl}(n, \mathbb{C})$ will not reduce under $\mathfrak{u}(n)$ follows immediately from our discussion concerning $\mathfrak{gl}(n, \mathbb{R})$. We summarize our findings in the following:

Theorem 30.3.3 *The irreducible representations of $GL(n, \mathbb{C})$ are also irreducible representations of $GL(n, \mathbb{R})$, $SL(n, \mathbb{C})$, $U(n)$, and $SU(n)$.*

The case of $SU(n)$ follows from the same argument given earlier that connected $GL(n, \mathbb{C})$ to $SL(n, \mathbb{C})$.

30.3.2 Casimir Operators

In the general representation theory of Lie algebras, it is desirable to label each irreducible representation with a quantity made out of the basis vectors of the Lie algebra. An example is the labeling of the energy states of a quantum mechanical system with angular momentum. Each value of the total angular momentum labels an irreducible subspace whose vectors are further labeled by the third component of angular momentum (see Chap. 13). This subsection is devoted to the generalization of this concept to an arbitrary Lie algebra.

Casimir operator defined

Definition 30.3.4 Let $\mathfrak{T} : \mathfrak{g} \rightarrow \mathfrak{gl}(\mathcal{H})$ be a representation of the Lie algebra \mathfrak{g} . A **Casimir operator** \mathbf{C} for this representation is an operator that commutes with all $\mathbf{T}_{\mathbf{X}}$ of the representation.

If the representation is irreducible, then by Schur’s lemma, \mathbf{C} is a multiple of the unit operator. Therefore, all vectors of an irreducible invariant subspace of the carrier space \mathcal{H} are eigenvectors of \mathbf{C} corresponding to the same eigenvalue. That Casimir operators actually determine the irreducible representations of a semisimple Lie algebra is the content of the following theorem (for a proof, see [Vara 84, pp. 333–337]).

Chevalley’s theorem

Theorem 30.3.5 (Chevalley) *For every semisimple Lie algebra \mathfrak{g} of rank⁴ r with a basis $\{\mathbf{X}_i\}$, there exists a set of r Casimir operators in the form of polynomials in $\mathbf{T}_{\mathbf{X}_i}$ whose eigenvalues characterize the irreducible representations of \mathfrak{g} .*

From now on, we shall use the notation \mathbf{X}_i for $\mathbf{T}_{\mathbf{X}_i}$. It follows from Theorem 30.3.5 that all irreducible invariant vector subspaces of the carrier space can be labeled by the eigenvalues of the r Casimir operators. This means that each invariant irreducible subspace has a basis all of whose vectors carry a set of r labels corresponding to the eigenvalues of the r Casimir operators.

One Casimir operator—in the form of a polynomial of degree two—which works only for semisimple Lie algebras, is obtained easily:

$$\mathbf{C} = \sum_{i,j} g^{ij} \mathbf{X}_i \mathbf{X}_j, \tag{30.13}$$

where g^{ij} is the inverse of the Cartan metric tensor. In fact, with the summation convention in place, we have

⁴Recall that the rank of \mathfrak{g} is the dimension of the Cartan subalgebra of \mathfrak{g} .

$$\begin{aligned}
 [\mathbf{C}, \mathbf{X}_k] &= g^{ij}[\mathbf{X}_i \mathbf{X}_j, \mathbf{X}_k] = g^{ij} \{ \mathbf{X}_i [\mathbf{X}_j, \mathbf{X}_k] + [\mathbf{X}_i, \mathbf{X}_k] \mathbf{X}_j \} \\
 &= g^{ij} \{ c_{jk}^r \mathbf{X}_i \mathbf{X}_r + c_{ik}^r \mathbf{X}_r \mathbf{X}_j \} \\
 &= g^{ij} c_{ik}^r (\mathbf{X}_j \mathbf{X}_r + \mathbf{X}_r \mathbf{X}_j) \quad (\text{because } g^{ij} \text{ is symmetric}) \\
 &= g^{ij} g^{sr} c_{iks} (\mathbf{X}_j \mathbf{X}_r + \mathbf{X}_r \mathbf{X}_j) \\
 &= 0 \quad (\text{because } g^{ij} g^{sr} c_{iks} \text{ is antisymmetric in } j, r).
 \end{aligned}$$

The last equality follows from the fact that g^{ij} and g^{sr} are symmetric, c_{iks} is completely antisymmetric [see the discussion following Eq. (29.50)], and there is a sum over the dummy index s .

Example 30.3.6 The rotation group $SO(3)$ in \mathbb{R}^3 is a compact 3-parameter Lie group. The infinitesimal generators are the three components of the angular momentum operator (see Example 29.1.35). From the commutation relations of the angular momentum operators developed in Chap. 13, we conclude that $c_{ij}^k = i\epsilon_{ijk}$. It follows that the Cartan metric tensor is

$$g_{ij} = c_{is}^r c_{jr}^s = (i\epsilon_{isr})(i\epsilon_{jrs}) = +\epsilon_{isr}\epsilon_{jrs} = 2\delta_{ij}.$$

Ignoring the factor of 2 and denoting the angular momentum operators by \mathbf{L}_i , we conclude that

irreducible representations of the rotation group and spherical harmonics

$$\mathbf{L}^2 \equiv \mathbf{L}_1^2 + \mathbf{L}_2^2 + \mathbf{L}_3^2$$

is a Casimir operator. But this is precisely the operator discussed in detail in Chap. 13. We found there that the eigenvalues of \mathbf{L}^2 were labeled by j , where j was either an integer or a half odd integer. In the context of our present discussion, we note that the Lie algebra $\mathfrak{so}(3)$ has rank one, because there is no higher dimensional subalgebra of $\mathfrak{so}(3)$ all of whose vectors commute with one another. It follows from Theorem 30.3.5 that \mathbf{L}^2 is the only Casimir operator, and that all irreducible representations $T^{(j)}$ of $\mathfrak{so}(3)$ are distinguished by their label j . Furthermore, the construction of Chap. 13 showed explicitly that the dimension of $T^{(j)}$ is $2j + 1$.

The connection between the representation of Lie algebras and Lie groups permits us to conclude that the irreducible representations of the rotation group are labeled by the (half) integers j , and the j th irreducible representation has dimension $2j + 1$. When j is an integer l and the carrier space is $\mathcal{L}^2(S^2)$, the square-integrable functions on the unit sphere, then \mathbf{L}^2 becomes a *differential operator*, and the spherical harmonics $Y_{lm}(\theta, \varphi)$, with a fixed value of l , provide a basis for the l th irreducible invariant subspace.

Connection between Casimir operators and the PDEs of mathematical physics

The last sentence of Example 30.3.6 is at the heart of the connection between symmetry, Lie groups, and the equations of mathematical physics. A symmetry operation of mathematical physics is expressed in terms of the action of a Lie group on an underlying manifold M , i.e., as a group of transformations of M . The Lie algebra of such a Lie group consists of the infinitesimal generators of the corresponding transformation. These generators can be expressed as first-order differential operators as in Eq. (29.25).

It is therefore natural to choose as the carrier space of a representation the Hilbert space $\mathcal{L}^2(M)$ of the square-integrable functions on M , which, through the local identification of M with \mathbb{R}^m ($m = \dim M$), can be identified with functions on \mathbb{R}^m . Then the infinitesimal generators act directly on the functions of $\mathcal{L}^2(M)$ as first-order differential operators.

The Casimir operators $\{\mathbf{C}_\alpha\}_{\alpha=1}^r$, where r is the rank of the Lie algebra, are polynomials in the infinitesimal generators, i.e., differential operators of higher order. On the irreducible invariant subspaces of $\mathcal{L}^2(M)$, each \mathbf{C}_α acts as a multiple of the identity, so if $f(\mathbf{r})$ belongs to such an invariant subspace, we have

$$\mathbf{C}_\alpha f(\mathbf{r}) = \lambda(\alpha) f(\mathbf{r}), \quad \alpha = 1, 2, \dots, r. \quad (30.14)$$

This is a set of differential equations that are invariant under the symmetry of the physical system, i.e., its solutions transform among themselves under the action of the group of symmetries.

It is a stunning reality and a fact of profound significance that many of the differential equations of mathematical physics are, as in Eq. (30.14), expressions of the invariance of the Casimir operators of some Lie algebra in a particular representation. Moreover, all the standard functions of mathematical physics, such as Bessel, hypergeometric, and confluent hypergeometric functions, are related to matrix elements in the representations of a few of the simplest Lie groups (see [Mill 68] for a thorough discussion of this topic).

Historical Notes

Claude Chevalley (1909–1984) was the only son of Abel and Marguerite Chevalley who were the authors of the Oxford Concise French Dictionary. He studied under Emile Picard at the Ecole Normale Supérieure in Paris, graduating in 1929 and becoming the youngest of the mathematicians of the Bourbaki school.

After graduation, Chevalley went to Germany to continue his studies under Artin at Hamburg during the session 1931–1932. He then went to the University of Marburg to work with Hasse, who had been appointed to fill Hensel's chair there in 1930. He was awarded his doctorate in 1937. A year later Chevalley went to the Institute for Advanced Study at Princeton, where he also served on the faculty of Princeton University. From July 1949 until June 1957 he served as professor of mathematics at Columbia University, afterwards returning to the University of Paris.

Chevalley had a major influence on the development of several areas of mathematics. His papers of 1936 and 1941 led to major advances in class field theory and also in algebraic geometry. He did pioneering work in the theory of local rings in 1943, developing the ideas of Krull into a theorem bearing his name. Chevalley's theorem was important in applications made in 1954 to quasi-algebraically closed fields and the following year to algebraic groups. Chevalley groups play a central role in the classification of finite simple groups. His name is also attached to Chevalley decompositions and to a Chevalley type of semi-simple algebraic group.

Many of his texts have become classics. He wrote *Theory of Lie Groups* in three volumes which appeared in 1946, 1951, and 1955. He also published *Theory of Distributions* (1951), *Introduction to the Theory of Algebraic Functions of one Variable* (1951), *The Algebraic Theory of Spinors* (1954), *Class Field Theory* (1954), *Fundamental Concepts of Algebra* (1956), and *Foundations of Algebraic Geometry* (1958).

Chevalley was awarded many honors for his work. Among these was the Cole Prize of the American Mathematical Society. He was elected a member of the London Mathematical Society in 1967.



Claude Chevalley
1909–1984

30.3.3 Representation of $\mathfrak{so}(3)$ and $\mathfrak{so}(3, 1)$

Because of their importance in physical applications, we study the representations of $\mathfrak{so}(3)$, the rotation, and $\mathfrak{so}(3, 1)$, the Lorentz, algebras. For rotations, we define $\mathbf{J}_1 \equiv -i\mathbf{M}_{23}$, $\mathbf{J}_2 \equiv i\mathbf{M}_{13}$, and $\mathbf{J}_3 \equiv -i\mathbf{M}_{12}$,⁵ and note that the \mathbf{J}_i 's satisfy exactly the same commutation relations as the angular momentum operators of Chap. 13. Therefore, the irreducible representations of $\mathfrak{so}(3)$ are labeled by j , which can be an integer or a half-odd integer (see also Example 30.3.6). These representations are finite-dimensional because $SO(3)$ is a compact group (Example 30.1.1 and Theorem 30.1.7). The dimension of the irreducible representation of $\mathfrak{so}(3)$ labeled by j is $2j + 1$.

Because of local isomorphism of Lie groups and their Lie algebras, the same irreducible spaces found for Lie algebras can be used to represent the Lie groups. In particular, the states $\{|jm\rangle\}_{m=-j}^j$, where m is the eigenvalue of \mathbf{J}_z , can also be used as a basis of the j -th irreducible representation.

The flow of each infinitesimal generator of $\mathfrak{so}(3)$ is a one-parameter subgroup of $SO(3)$. For example, $\exp(\mathbf{M}_{12}\varphi)$ is a rotation of angle φ about the z -axis. Using Euler angles, we can write a general rotation as

$$\mathbf{R}(\psi, \theta, \varphi) = \exp(\mathbf{M}_{12}\psi) \exp(\mathbf{M}_{31}\theta) \exp(\mathbf{M}_{12}\varphi).$$

The corresponding rotation *operator* acting on the vectors of the carrier space is

$$\mathbf{R}(\psi, \theta, \varphi) = \exp(\mathbf{M}_{12}\psi) \exp(\mathbf{M}_{31}\theta) \exp(\mathbf{M}_{12}\varphi) = e^{i\mathbf{J}_z\psi} e^{i\mathbf{J}_y\theta} e^{i\mathbf{J}_z\varphi}.$$

rotation matrix The **rotation matrix** corresponding to the above operator is obtained by sandwiching $\mathbf{R}(\psi, \theta, \varphi)$ between basis vectors of a given irreducible representation:

$$\begin{aligned} D_{m'm}^{(j)}(\psi, \theta, \varphi) &\equiv \langle jm' | \mathbf{R}(\psi, \theta, \varphi) | jm \rangle = \langle jm' | e^{i\mathbf{J}_z\psi} e^{i\mathbf{J}_y\theta} e^{i\mathbf{J}_z\varphi} | jm \rangle \\ &= e^{im'\psi} e^{im\varphi} \langle jm' | e^{i\mathbf{J}_y\theta} | jm \rangle = e^{i(m'\psi + m\varphi)} d_{m'm}^{(j)}(\theta). \end{aligned} \tag{30.15}$$

Wigner formula for rotation matrices Thus, the calculation of rotation matrices is reduced to finding $d_{m'm}^{(j)}(\theta)$. These are given by the **Wigner formula** (see [Hame 89, pp. 348–357]):

$$d_{m'm}^{(j)}(\theta) = \sum_{\mu} \phi(j, m, m'; \mu) \left(\cos \frac{\theta}{2}\right)^{2(j-\mu)+m-m'} \left(\sin \frac{\theta}{2}\right)^{2\mu+m'-m} \tag{30.16}$$

where

$$\phi(j, m, m'; \mu) \equiv (-1)^{\mu} \frac{[(j+m)!(j-m)!(j+m')!(j-m')!]^{1/2}}{(j+m-\mu)!\mu!(j-m'-\mu)!(m'-m+\mu)!}$$

and the summation extends over all integral values of μ for which the factorials have a meaning. The number of terms in the summation is equal to $1 + \tau$, where τ is the smallest of the four integers $j \pm m, j \pm m'$.

⁵Sometimes we use $\mathbf{J}_x, \mathbf{J}_y$, and \mathbf{J}_z instead of $\mathbf{J}_1, \mathbf{J}_2$, and \mathbf{J}_3 .

From the rotation matrices, we can obtain the characters of the rotation group. However, an easier way is to use Euler's theorem (Theorem 6.6.15), Example 23.2.19, and Box 24.3.6 to conclude that the character of a rotation depends only on the angle of rotation, and not on the direction of the rotation axis. Choosing the z -axis as our only axis of rotation, we obtain

$$\begin{aligned}\chi^{(j)}(\varphi) &= \sum_{m=-j}^j \langle jm | e^{iJ_z\varphi} | jm \rangle = \sum_{m=-j}^j e^{im\varphi} = e^{-ij\varphi} \sum_{m=-j}^j e^{i(j+m)\varphi} \\ &= e^{-ij\varphi} \sum_{k=0}^{2j} e^{ik\varphi} = e^{-ij\varphi} \frac{e^{i(2j+1)\varphi} - 1}{e^{i\varphi} - 1} \\ &= \frac{e^{i(j+1)\varphi} - e^{-ij\varphi}}{e^{i\varphi} - 1} = \frac{\sin(j + \frac{1}{2})}{\sin(\varphi/2)}.\end{aligned}\quad (30.17)$$

Equation (30.17) can be used to obtain the celebrated **addition theorem** for angular momenta. Suppose that initially we have two physical systems corresponding to angular momenta j_1 and j_2 . When these systems are made to interact with one another, the total system will be described by the tensor product states. These states are vectors in the tensor product of the irreducible representations $T^{(j_1)}$ and $T^{(j_2)}$ of the rotation group, as discussed in Sect. 24.8. This product is reducible. To find the factors into which it reduces, we consider its character corresponding to angle φ . Using Eq. (24.42), we have

$$\begin{aligned}\chi^{(j_1 \times j_2)}(\varphi) &= \chi^{(j_1)}(\varphi) \cdot \chi^{(j_2)}(\varphi) = \sum_{m_1=-j_1}^{j_1} e^{im_1\varphi} \sum_{m_2=-j_2}^{j_2} e^{im_2\varphi} \\ &= \sum_{m_1=-j_1}^{j_1} \sum_{m_2=-j_2}^{j_2} e^{i(m_1+m_2)\varphi} \\ &= \sum_{J=|j_1-j_2|}^{j_1+j_2} \sum_{M=-J}^J e^{iM\varphi} = \sum_{J=|j_1-j_2|}^{j_1+j_2} \chi^{(J)}(\varphi),\end{aligned}$$

where the double sum on the third line is an equivalent way of writing the double summation of the second line, as the reader may verify. From this equation we read off the Clebsch-Gordan decomposition of the tensor product:

addition theorem for
angular momenta

$$T^{(j_1)} \otimes T^{(j_2)} = \sum_{J=|j_1-j_2|}^{j_1+j_2} T^{(J)}, \quad (30.18)$$

which is also known as the addition theorem for angular momenta. Equation (30.18) shows that (see page 753).

Box 30.3.7 *The rotation group is simply reducible.*

The RHS of Eq. (30.18) tells us which irreducible representations result from multiplying $T^{(j_1)}$ and $T^{(j_2)}$. In particular, if $j_1 = j_2 \equiv l$, the RHS includes the $J = 0$ representation, i.e., a scalar. In terms of the states, this says that we can combine two states with angular momentum l to obtain a scalar state. Let us find this combination. We use Eq. (24.46) in the form

$$|JM\rangle = \sum_{m_1, m_2} C(j_1 j_2; J | m_1 m_2; M) |j_1, m_1; j_2, m_2\rangle, \quad m_1 + m_2 = M. \quad (30.19)$$

In the case under investigation, $J = 0 = M$, so (30.19) becomes

$$|00\rangle = \sum_{m=-l}^l C(l l; 0 | m, -m; 0) |lm; l, -m\rangle.$$

Problem 30.9 shows that $C(l l; 0 | m, -m; 0) = (-1)^{l-m} / \sqrt{2l+1}$, so that

$$|00\rangle = \sum_{m=-l}^l \frac{(-1)^{l-m}}{\sqrt{2l+1}} |lm; l, -m\rangle.$$

Take the “inner product” of this with $\langle \theta, \varphi; \theta', \varphi' |$ to obtain

$$\begin{aligned} \langle \theta, \varphi; \theta', \varphi' | 00 \rangle &= \sum_{m=-l}^l \frac{(-1)^{l-m}}{\sqrt{2l+1}} \langle \theta, \varphi; \theta', \varphi' | lm; l, -m \rangle \\ &= \sum_{m=-l}^l \frac{(-1)^{l-m}}{\sqrt{2l+1}} \underbrace{\langle \theta, \varphi | lm \rangle}_{Y_{lm}(\theta, \varphi)} \underbrace{\langle \theta', \varphi' | l, -m \rangle}_{Y_{l, -m}(\theta', \varphi')}, \end{aligned} \quad (30.20)$$

where we have used $\langle \theta, \varphi; \theta', \varphi' | = \langle \theta, \varphi | \langle \theta', \varphi' |$ and contracted each bra with a ket. We can evaluate the LHS of (30.20) by noting that since it is a scalar, the choice of orientation of coordinates is immaterial. So, let $\theta = 0$ to get $\theta' = \gamma$, the angle between the two directions. Then using the facts

$$Y_{lm}(0, \varphi) = \delta_{m0} \sqrt{\frac{2l+1}{4\pi}} \quad \text{and} \quad Y_{l0}(\theta, \varphi) = \sqrt{\frac{2l+1}{4\pi}} P_l(\cos \theta)$$

on the RHS of (30.20), we obtain

$$\langle \theta, \varphi; \theta', \varphi' | 00 \rangle = \frac{(-1)^l}{4\pi} \sqrt{2l+1} P_l(\cos \gamma).$$

Substituting this in the LHS of Eq. (30.20), we get

$$P_l(\cos \gamma) = \frac{4\pi}{2l+1} \sum_{m=-l}^l (-1)^m Y_{lm}(\theta, \varphi) Y_{l, -m}(\theta', \varphi'),$$

which is the addition theorem for spherical harmonics discussed in Chap. 13.

Let us now turn to $\mathfrak{so}(3, 1)$. We collect the generators in two categories

$$\mathbf{M} \equiv (M_1, M_2, M_3) \equiv (\mathbf{M}_{23}, \mathbf{M}_{31}, \mathbf{M}_{12}),$$

$$\mathbf{N} \equiv (N_1, N_2, N_3) \equiv (\mathbf{M}_{01}, \mathbf{M}_{02}, \mathbf{M}_{03}),$$

and verify that

$$[M_i, M_j] = -\epsilon_{ijk} M_k, \quad [N_i, N_j] = \epsilon_{ijk} M_k, \quad [M_i, N_j] = -\epsilon_{ijk} N_k,$$

and that there are two Casimir operators: $\mathbf{M}^2 - \mathbf{N}^2$ and $\mathbf{M} \cdot \mathbf{N}$. It follows that the irreducible representations of $\mathfrak{so}(3, 1)$ are labeled by two numbers. To find these numbers, define the generators

$$\mathbf{J} \equiv \frac{1}{2i}(\mathbf{M} + i\mathbf{N}), \quad \mathbf{K} \equiv \frac{1}{2i}(\mathbf{M} - i\mathbf{N}),$$

and show that

$$[J_i, J_m] = \epsilon_{imk} J_k, \quad [K_i, K_j] = \epsilon_{ijm} K_m, \quad [J_i, K_j] = 0.$$

It follows that the J 's and the K 's generate two completely independent Lie algebras isomorphic to the angular momentum algebras and that $\mathfrak{so}(3, 1)$ is a direct sum of these algebras. Since each one requires a (half-odd) integer to designate its irreducible representations, we can choose these two numbers as the eigenvalues of the Casimir operators needed to label the irreducible representations of $\mathfrak{so}(3, 1)$. Thus, the irreducible representations of $\mathfrak{so}(3, 1)$ are of the form $T^{(jj')}$, where j and j' can each be an integer or a half-odd integer.

30.3.4 Representation of the Poincaré Algebra

The Poincaré algebra $\mathfrak{p}(p, n - p)$, introduced in Sect. 29.2.1, is the generalization of the Lie algebra of the invariance group of the special theory of relativity. It contains the Lorentz, the rotation, and the translation groups as its proper subgroups. Its irreducible representations are of direct physical significance, and we shall study them here.

As the first step in the construction of representations of $\mathfrak{p}(p, n - p)$, we shall try to find its Casimir operators. Eq. (30.13) suggests one, but it works only for semisimple Lie algebras, and the Poincaré algebra is not semisimple. Nevertheless, let us try to find an operator based on that construction. From the commutation relations for $\mathfrak{p}(p, n - p)$, as given in Eq. (29.45), and the double-indexed structure constants defined by,⁶

$$[M_{ij}, M_{kl}] = c_{ij,kl}^{mn} M_{mn}, \quad [M_{ij}, P_k] = c_{ij,k}^m P_m,$$

we obtain

$$\begin{aligned} c_{ij,kl}^{mn} &= \delta_j^m \delta_l^n \eta_{ik} - \delta_j^m \delta_k^n \eta_{il} + \delta_i^m \delta_k^n \eta_{jl} - \delta_i^m \delta_l^n \eta_{jk}, \\ c_{ij,k}^m &= \delta_j^m \eta_{ik} - \delta_i^m \eta_{jk}. \end{aligned} \quad (30.21)$$

⁶Please make sure to differentiate between the pair (M_{ij}, P_k) (which acts on \mathfrak{p}) and the pair $(\mathbf{M}_{ij}, \mathbf{P}_k)$, which acts on the state vectors in the Hilbert space of representation.

From these structure constants, we can construct a double indexed “metric”

$$g_{ij,kl} = c_{ij,mn}^{rs} c_{kl,rs}^{mn} + c_{ij,m}^r c_{kl,r}^m,$$

which the reader may verify to be equal to

$$g_{ij,kl} = 2(n - 1)(\eta_{jk}\eta_{il} - \eta_{ik}\eta_{jl}).$$

There is no natural way of constructing a single-indexed metric. Therefore, we can only contract the \mathbf{M} 's. In doing so, it is understood that the indices are raised and lowered by η_{ij} . So, the first candidate for a Casimir operator is

$$\mathbf{M}^2 \equiv g_{ij,kl} \mathbf{M}^{ij} \mathbf{M}^{kl} = 2(n - 1)(\eta_{jk}\eta_{il} - \eta_{ik}\eta_{jl}) \mathbf{M}^{ij} \mathbf{M}^{kl} = -4(n - 1) \mathbf{M}^{ij} \mathbf{M}_{ij}$$

The reader may verify that \mathbf{M}^2 commutes with all the \mathbf{M}^{ij} 's but not with the \mathbf{P}^i 's. This is to be expected because \mathbf{M}^2 , the total “angular momentum” operator⁷ is a scalar and should commute with all its components. But commutation with the \mathbf{P}^i 's is not guaranteed.

The construction above, although a failure, gives us a clue for a successful construction. We can make another scalar out of the \mathbf{P} 's. The reader may check that $\mathbf{P}^2 \equiv \eta^{ij} \mathbf{P}_i \mathbf{P}_j$ indeed commutes with all elements of the Poincaré algebra. We have thus found one Casimir operator. Can we find more? We have exhausted the polynomials of degree two. The only third-degree polynomials that we can construct are $\mathbf{M}^{ij} \mathbf{P}_i \mathbf{P}_j$ and $\eta_{il} \mathbf{M}^{ij} \mathbf{M}_{jk} \mathbf{M}^{kl}$. The first one is identically zero (why?), and the second one will not commute with the \mathbf{P} 's.

To find higher-order polynomials in the infinitesimal generators, we build new tensors out of them and contract these tensors with one another. For example, consider the vector

$$\mathbf{C}_i \equiv \mathbf{M}_{ij} \mathbf{P}^j = \eta^{kj} \mathbf{M}_{ij} \mathbf{P}_k. \tag{30.22}$$

Then $\mathbf{C}^i \mathbf{C}_i$, a fourth-degree polynomial in the generators, is a scalar, and therefore, it commutes with the \mathbf{M}_{ij} 's, but unfortunately, not with \mathbf{P}_i 's.

Another common way to construct tensors is to contract various numbers of the generators with the Levi-Civita tensor. For example,

$$\mathbf{W}^{i_1 \dots i_{n-3}} \equiv \epsilon^{i_1 \dots i_{n-3} jkl} \mathbf{M}_{jk} \mathbf{P}_l \tag{30.23}$$

is a contravariant tensor of rank $n - 3$. Let us contract \mathbf{W} with itself to find a scalar (which we expect to commute with all the \mathbf{M}_{ij} 's):

$$\begin{aligned} \mathbf{W}^2 &\equiv \mathbf{W}^{i_1 \dots i_{n-3}} \mathbf{W}_{i_1 \dots i_{n-3}} \\ &= \epsilon^{i_1 \dots i_{n-3} jkl} \mathbf{M}_{jk} \mathbf{P}_l \epsilon_{i_1 \dots i_{n-3} rst} \mathbf{M}^{rs} \mathbf{P}^t \\ &= (-1)^{n-} \sum_{\pi} \epsilon_{\pi} \delta_{\pi(i_1)}^{i_1} \delta_{\pi(i_2)}^{i_2} \dots \delta_{\pi(i_{n-3})}^{i_{n-3}} \delta_{\pi(r)}^j \delta_{\pi(s)}^k \delta_{\pi(t)}^l \mathbf{M}_{jk} \mathbf{P}_l \mathbf{M}^{rs} \mathbf{P}^t \\ &= (-1)^P (n - 3)! \sum_{\pi} \epsilon_{\pi} \delta_{\pi(r)}^j \delta_{\pi(s)}^k \delta_{\pi(t)}^l \mathbf{M}_{jk} \mathbf{P}_l \mathbf{M}^{rs} \mathbf{P}^t, \end{aligned}$$

⁷This “angular momentum” includes ordinary rotations as well as the Lorentz boosts.

where we used Eq. (26.45). The sum above can be carried out, with the final result

$$\begin{aligned}\mathbf{W}^2 &= 2(-1)^p(n-3)!(\mathbf{M}_{ij}\mathbf{M}^{ij}\mathbf{P}^2 - 2\mathbf{C}_i\mathbf{C}^i) \\ &= 2(-1)^p(n-3)!(\mathbf{M}^2\mathbf{P}^2 - 2\mathbf{C}^2),\end{aligned}\quad (30.24)$$

where \mathbf{C}_i was defined in Eq. (30.22). We have already seen that \mathbf{M}^2 , \mathbf{P}^2 , and \mathbf{C}^2 all commute with the \mathbf{M}_{jk} 's. The reader may check that \mathbf{W}^2 commutes with the \mathbf{P}_j 's as well. In fact, $\mathbf{W}^{i_1\dots i_{n-3}}$ itself commutes with all the \mathbf{P}_j 's. Other tensors and Casimir operators can be constructed in a similar fashion.

We now want to construct the irreducible vector spaces that are labeled by the eigenvalues of the Casimir operators. We take advantage of the fact that the Poincaré algebra has a commutative subalgebra, the translation generators. Since the \mathbf{P}_k 's commute among themselves and with \mathbf{P}^2 and \mathbf{W}^2 , we can choose simultaneous eigenvectors of $\{\mathbf{P}_k\}_{k=1}^n$, \mathbf{P}^2 , and \mathbf{W}^2 . In particular, we can label the vectors of an irreducible invariant subspace by the eigenvalues of these operators. The \mathbf{P}^2 and \mathbf{W}^2 labels will be the same for all vectors in each irreducible invariant subspace, while the \mathbf{P}_k 's will label different vectors of the same invariant subspace.

Let us concentrate on the momentum labels and let $|\psi_{\mathbf{p}}^\mu\rangle$ be a vector in an irreducible representation of $\mathfrak{p}(p, n-p)$, where \mathbf{p} labels momenta and μ distinguishes among all different vectors that have the same momentum label. We thus have

$$\mathbf{P}_k|\psi_{\mathbf{p}}^\mu\rangle = p_k|\psi_{\mathbf{p}}^\mu\rangle \quad \text{for } k = 1, 2, \dots, n, \quad (30.25)$$

where p_k is the eigenvalue of \mathbf{P}_k . We also need to know how the ‘‘rotation’’ operators act on $|\psi_{\mathbf{p}}^\mu\rangle$. Instead of the full operator $e^{\mathbf{M}_{ij}\theta^{ij}}$, we apply its small-angle approximation $\mathbf{1} + \mathbf{M}_{ij}\theta^{ij}$. Since all states are labeled by momentum, we expect the rotated state to have a new momentum label, i.e., to be an eigenstate of \mathbf{P}_k . We want to show that $(\mathbf{1} + \mathbf{M}_{ij}\theta^{ij})|\psi_{\mathbf{p}}^\mu\rangle$ is an eigenvector of \mathbf{P}_k . Let the eigenvalue be \mathbf{p}' , which should be slightly different from \mathbf{p} . Then, the problem reduces to determining $\delta\mathbf{p}' \equiv \mathbf{p}' - \mathbf{p}$. Ignoring the index μ for a moment, we have

$$\mathbf{P}_k|\psi_{\mathbf{p}'}\rangle = p'_k|\psi_{\mathbf{p}'}\rangle = (p_k + \delta p_k)(\mathbf{1} + \mathbf{M}_{ij}\theta^{ij})|\psi_{\mathbf{p}}\rangle.$$

Using the commutation relations between \mathbf{P}_k and \mathbf{M}_{ij} , we can write the LHS as

$$\text{LHS} = \mathbf{P}_k(\mathbf{1} + \mathbf{M}_{ij}\theta^{ij})|\psi_{\mathbf{p}}\rangle = [p_k + \theta^{ij}(\mathbf{M}_{ij}p_k + \eta_{jk}p_i - \eta_{ik}p_j)]|\psi_{\mathbf{p}}\rangle.$$

The RHS, to first order in infinitesimal quantities, can be expressed as

$$\text{RHS} = (p_k + \delta p_k + p_k\theta^{ij}\mathbf{M}_{ij})|\psi_{\mathbf{p}}\rangle.$$

Comparison of the last two equations shows that

$$\delta p_k = \theta^{ij}(\eta_{jk}p_i - \eta_{ik}p_j) = \theta^{ij}(\eta_{jk}\eta_{il} - \eta_{ik}\eta_{jl})p^l = \theta^{ij}(\mathbf{M}_{ij})_{kl}p^l,$$

where we used Eq. (29.42). It follows that

$$\mathbf{p}' = \mathbf{p} + \delta\mathbf{p} = (\mathbf{1} + \theta^{ij}M_{ij})\mathbf{p},$$

stating that the rotation operator of the carrier Hilbert space rotates the momentum label of the state. Note that since “rotations” do not change the length (induced by η), \mathbf{p}' and \mathbf{p} have the same length.

construction and
properties of the little
group

To obtain all the vectors of an irreducible representation of $\mathfrak{p}(p, n - p)$, we must apply the rotation operators to vectors such as $|\psi_{\mathbf{p}}^{\mu}\rangle$. But not all rotations will change the label \mathbf{p} ; for example, in three dimensions, the vector \mathbf{p} will not be affected⁸ by a rotation about \mathbf{p} . This motivates the following definition.

little group and little
algebra

Definition 30.3.8 Let \mathbf{p}_0 be any given eigenvalue of the translation generators. The set $\mathcal{R}_{\mathbf{p}_0}$ of all rotations $A^{\mathbf{p}_0}$ that do not change \mathbf{p}_0 , is a subgroup of the rotation group $O(p, n - p)$, called the **little group** corresponding to \mathbf{p}_0 . The **little algebra** consists of the generators $M_{ij}^{\mathbf{p}_0}$ satisfying

$$M_{ij}^{\mathbf{p}_0}\mathbf{p}_0 = 0.$$

induced representations

The significance of the little group resides in the fact that a representation of $\mathcal{R}_{\mathbf{p}_0}$ induces a representation of the whole Poincaré group. We shall only sketch the proof in the following and refer the reader to Mackey [Mack 68] for a full and rigorous discussion of **induced representations**.

Suppose we have found an irreducible representation of $\mathcal{R}_{\mathbf{p}_0}$ with operators $\mathbf{A}^{\mathbf{p}_0}$. Let $A^{\mathbf{p}\mathbf{p}_0}$ be the rotation that carries⁹ \mathbf{p}_0 to \mathbf{p} , i.e., $\mathbf{p} = A^{\mathbf{p}\mathbf{p}_0}\mathbf{p}_0$. Consider any rotation A and let \mathbf{p}' be the momentum obtained when A acts on \mathbf{p} , i.e., $A\mathbf{p} \equiv \mathbf{p}'$. Then

$$\underbrace{AA^{\mathbf{p}\mathbf{p}_0}}_{=\mathbf{p}}\mathbf{p}_0 = \underbrace{A^{\mathbf{p}'\mathbf{p}_0}}_{=\mathbf{p}'}\mathbf{p}_0 \Rightarrow (A^{\mathbf{p}'\mathbf{p}_0})^{-1}AA^{\mathbf{p}\mathbf{p}_0}\mathbf{p}_0 = \mathbf{p}_0.$$

This shows that $(A^{\mathbf{p}'\mathbf{p}_0})^{-1}AA^{\mathbf{p}\mathbf{p}_0}$ belongs to the little group. So,

$$(A^{\mathbf{p}'\mathbf{p}_0})^{-1}AA^{\mathbf{p}\mathbf{p}_0} = A^{\mathbf{p}_0}$$

for some $A^{\mathbf{p}_0} \in \mathcal{R}_{\mathbf{p}_0}$. Thus, $A = A^{\mathbf{p}'\mathbf{p}_0}A^{\mathbf{p}_0}(A^{\mathbf{p}\mathbf{p}_0})^{-1}$, and

$$\begin{aligned} T(A)|\psi_{\mathbf{p}}^{\mu}\rangle &\equiv \mathbf{A}|\psi_{\mathbf{p}}^{\mu}\rangle = A^{\mathbf{p}'\mathbf{p}_0}A^{\mathbf{p}_0}(A^{\mathbf{p}\mathbf{p}_0})^{-1}|\psi_{\mathbf{p}}^{\mu}\rangle = A^{\mathbf{p}'\mathbf{p}_0}A^{\mathbf{p}_0}|\psi_{\mathbf{p}_0}^{\mu}\rangle \\ &= A^{\mathbf{p}'\mathbf{p}_0} \sum_{\nu} T_{\nu\mu}(A^{\mathbf{p}_0})|\psi_{\mathbf{p}_0}^{\nu}\rangle = \sum_{\nu} T_{\nu\mu}(A^{\mathbf{p}_0})A^{\mathbf{p}'\mathbf{p}_0}|\psi_{\mathbf{p}_0}^{\nu}\rangle \\ &= \sum_{\nu} T_{\nu\mu}(A^{\mathbf{p}_0})|\psi_{\mathbf{p}'}^{\nu}\rangle = \sum_{\nu} T_{\nu\mu}(A^{\mathbf{p}_0})|\psi_{A\mathbf{p}}^{\nu}\rangle. \end{aligned}$$

⁸The reader should be warned that although such a rotation does not change \mathbf{p} , the rotation operator may change the state $|\psi_{\mathbf{p}}\rangle$. However, the resulting state will be an eigenstate of the \mathbf{P}_k 's with eigenvalue \mathbf{p} .

⁹We are using the fact that $O(p, n - p)$ is transitive (see Problem 30.15).

Note how the matrix elements of the representation of *the little group alone* have entered in the last line. We therefore consider

$$T(\mathbf{A})|\psi_{\mathbf{p}}^{\mu}\rangle \equiv \sum_{\nu} R_{\nu\mu}(\mathbf{A}^{\mathbf{p}_0})|\psi_{\mathbf{A}\mathbf{p}}^{\nu}\rangle, \quad \text{where} \quad \begin{cases} \mathbf{A} = \mathbf{A}^{\mathbf{p}'\mathbf{p}_0}\mathbf{A}^{\mathbf{p}_0}(\mathbf{A}^{\mathbf{p}\mathbf{p}_0})^{-1}, \\ \mathbf{p}' \equiv \mathbf{A}\mathbf{p}. \end{cases} \quad (30.26)$$

To avoid confusion, we have used R for the representation of the little group. We claim that Eq. (30.26) defines a (matrix) representation of the whole group. In fact,

$$\begin{aligned} T(\mathbf{A}_1)T(\mathbf{A}_2)|\psi_{\mathbf{p}}^{\mu}\rangle &= T(\mathbf{A}_1) \sum_{\nu} R_{\nu\mu}(\mathbf{A}_2^{\mathbf{p}_0})|\psi_{\mathbf{A}_2\mathbf{p}}^{\nu}\rangle \\ &= \sum_{\nu} R_{\nu\mu}(\mathbf{A}_2^{\mathbf{p}_0}) \sum_{\rho} R_{\rho\nu}(\mathbf{A}_1^{\mathbf{p}_0})|\psi_{\mathbf{A}_1\mathbf{A}_2\mathbf{p}}^{\rho}\rangle \\ &= \sum_{\rho} \left(\underbrace{\sum_{\nu} R_{\rho\nu}(\mathbf{A}_1^{\mathbf{p}_0})R_{\nu\mu}(\mathbf{A}_2^{\mathbf{p}_0})}_{=R_{\rho\mu}(\mathbf{A}_1^{\mathbf{p}_0}\mathbf{A}_2^{\mathbf{p}_0}) \text{ since } R \text{ is a rep.}} \right) |\psi_{\mathbf{A}_1\mathbf{A}_2\mathbf{p}}^{\rho}\rangle. \end{aligned}$$

The reader may check that $\mathbf{A}_1^{\mathbf{p}_0}\mathbf{A}_2^{\mathbf{p}_0} \equiv (\mathbf{A}_1\mathbf{A}_2)^{\mathbf{p}_0}$. Therefore,

$$T(\mathbf{A}_1)T(\mathbf{A}_2)|\psi_{\mathbf{p}}^{\mu}\rangle = \sum_{\rho} R_{\rho\mu}((\mathbf{A}_1\mathbf{A}_2)^{\mathbf{p}_0})|\psi_{\mathbf{A}_1\mathbf{A}_2\mathbf{p}}^{\rho}\rangle \equiv T(\mathbf{A}_1\mathbf{A}_2)|\psi_{\mathbf{p}}^{\mu}\rangle,$$

and T is indeed a representation. It turns out that if R is irreducible, then so is T . The discussion above shows that the irreducible representations of the Poincaré group are entirely determined by those of the little group and Eq. (30.25). The recipe for the construction of the irreducible representations of $\mathfrak{p}(p, n-p)$ is now clear:

Theorem 30.3.9 Choose any simultaneous eigenvector \mathbf{p}_0 of the \mathbf{P}_k 's. Find the little algebra $\mathfrak{K}_{\mathbf{p}_0}$ at \mathbf{p}_0 by finding all M_{ij} 's satisfying $M_{ij}\mathbf{p}_0 = 0$. Find all irreducible representations of $\mathfrak{K}_{\mathbf{p}_0}$. The same eigenvalues that label the irreducible representations of $\mathfrak{K}_{\mathbf{p}_0}$ can be used, in addition to those of \mathbf{P}^2 and \mathbf{W}^2 , to label the irreducible representations of $\mathfrak{p}(p, n-p)$.

We are particularly interested in $\mathfrak{p}(3, 1)$, the symmetry group of the special theory of relativity. In applying the formalism developed above, we need to make contact with the physical world. This always involves interpretations. Borrowing from the angular momentum theory, in which a physical system was given the attribute of angular momentum, the label of the irreducible representation of the rotation group, we attribute the labels of an irreducible representation of the Poincaré group, i.e., the eigenvalues of the four translation generators and the two Casimir operators, to a physical system. Since the four translation generators are identified as the three

components of momentum and energy, and their specification implies their constancy over time, we have to come to the conclusion that

Box 30.3.10 *An irreducible representation of the Poincaré group specifies a free relativistic particle.*

There may be some internal interactions between constituents of a (composite) particle, e.g. between quarks inside a proton, but as a whole, the composite will be interpreted as a single particle. To construct the little group, we have to specify a 4-momentum \mathbf{p}_0 . We shall consider two cases: In the first case, $\mathbf{p}_0 \cdot \mathbf{p}_0 \neq 0$, whereby the particle is deduced to be massive and we can choose¹⁰ $\mathbf{p}_0 = (0, 0, 0, m)$. In the second case, $\mathbf{p}_0 \cdot \mathbf{p}_0 = 0$, in which case the particle is massless, and we can choose $\mathbf{p}_0 = (p, 0, 0, p)$. We consider these two cases separately.

The little group (really, the little Lie algebra) for $\mathbf{p}_0 = (0, 0, 0, m)$ is obtained by searching for those rotations that leave \mathbf{p}_0 fixed. This is equivalent to searching for M_{ij} 's that annihilate $(0, 0, 0, m)$, namely, the solutions to

$$(M_{ij}\mathbf{p}_0)_l = (M_{ij})_{lr}(\mathbf{p}_0)^r = (M_{ij})_{l0}m = 0 \quad \Rightarrow \quad (M_{ij})_{l0} = 0.$$

Since $(M_{ij})_{l0} = \eta_{i0}\eta_{jl} - \eta_{j0}\eta_{il}$, we conclude that $(M_{ij})_{l0} = 0$ if and only if $i \neq 0$ and $j \neq 0$. Thus the little group is generated by (M_{23}, M_{31}, M_{12}) which are the components of angular momentum. The reader may also verify directly that when the 4-momentum has only a time component, the Casimir operator \mathbf{W}^2 reduces essentially to the total angular momentum operator. Since we are dealing with a single particle, the total angular momentum can only be spin. Therefore, we have the following theorem.

Theorem 30.3.11 *In the absence of any interactions, a massive relativistic particle is specified by its mass m and its spin s , the former being any positive number, the latter taking on integer or half-odd-integer values.*

The case of the massless particle can be handled in the same way. We seek those M_{ij} 's that annihilate $(p, 0, 0, p)$, namely, the solutions to

$$(M_{ij}\mathbf{p}_0)_k = (M_{ij})_{kr}(\mathbf{p}_0)^r = (M_{ij})_{k0}p + (M_{ij})_{k1}p = 0.$$

The reader may check that

$$\begin{aligned} (M_{01}\mathbf{p}_0)_k &= \eta_{1k}p - \eta_{0k}p, & (M_{02}\mathbf{p}_0)_k &= \eta_{2k}p, & (M_{03}\mathbf{p}_0)_k &= \eta_{3k}p, \\ (M_{23}\mathbf{p}_0)_k &= 0, & (M_{12}\mathbf{p}_0)_k &= \eta_{2k}p, & (M_{13}\mathbf{p}_0)_k &= \eta_{3k}p. \end{aligned}$$

¹⁰We use units in which $c = 1$.

Clearly, M_{23} is one of the generators of the little group. Subtracting the middle terms and the last terms of each line, we see that $M_{02} - M_{12}$ and $M_{03} - M_{13}$ are the other two generators. These happen to be the components of W . In fact, it is easily verified that

$$\begin{aligned} W^0 &= W^1 = M_{23}p, & W^2 &= 2p(M_{13} - M_{03}), \\ W^3 &= 2p(M_{02} - M_{12}). \end{aligned} \quad (30.27)$$

Therefore, the little group is generated by all the components of W . Furthermore, W^2 has zero eigenvalue for $|\psi_{\mathbf{p}_0}\rangle$ when $\mathbf{p}_0 = (p, 0, 0, p)$. Since both Casimir operators annihilate the state $|\psi_{\mathbf{p}_0}\rangle$, we need to come up with another way of labeling the states.

Historical Notes

Eugene Paul Wigner (1902–1995) was the second of three children born to Hungarian Jewish parents in Budapest. His father operated a large leather tannery and hoped that his son would follow him in that vocation, but the younger Wigner soon discovered both a taste and an aptitude for mathematics and physics. Although Wigner tried hard to accommodate his father’s wishes, he clearly heard his calling, and the world of physics is fortunate that he did.

Wigner began his education in what he said “may have been the finest high school in the world.” He later studied chemical engineering and returned to Budapest to apply that training in his father’s tannery. He kept track of the seminal papers during the early years of quantum theory and, when the lure of physics became too strong, returned to Berlin to work in a crystallography lab. He lectured briefly at the University of Göttingen before moving to America to escape the Nazis.

Wigner accepted a visiting professorship to Princeton in 1930. When the appointment was not made permanent, the disappointed young professor moved to the University of Wisconsin, where he served happily until his new wife died suddenly of cancer only a few months after their marriage. As Wigner prepared, quite understandably, to leave Wisconsin, Princeton corrected its earlier mistake and offered him a permanent position. Except for occasional visiting appointments in America and abroad, he remained at Princeton until his death.

Wigner’s contributions to mathematical physics began during his studies in Berlin, where his supervisor suggested a problem dealing with the symmetry of atoms in a crystal. John von Neumann, a fellow Hungarian physicist, pointed out the relevance of papers by Frobenius and Schur on representation theory. Wigner soon became enamored with the group theory inherent in the problem and began to apply that approach to quantum mechanical problems. Largely at the urging of Leo Szilard (another Hungarian physicist and Wigner’s best friend), Wigner collected many of his results into the classic textbook *Group Theory and Its Application to the Quantum Mechanics of Atomic Spectra*.

The decades that followed were filled with important contributions to mathematical physics, with applications of group theory comprising a large share: angular momentum; nuclear physics and $SU(4)$ or “supermultiplet” theory; parity; and studies of the Lorentz group and Wigner’s classic definition of an elementary particle. Other work included early efforts in many-body theory and a paper on level spacings derived from the properties of Hermitian matrices that later proved useful to workers in quantum chaos.

As with most famous figures, Wigner’s personality became as well known as his professional accomplishments. His insistence on “reasonable” behavior, for instance, made him refuse to pay a relative’s hospital bill until after the patient was released—it was obviously unreasonable to hold a sick person hostage. His gentleness is exemplified in an anecdote in which on getting into an argument about a tip with a New York City cab driver, Wigner loses his patience, stamps his foot, and says, “Oh, go to hell, . . . please!”

He held others’ feelings in such high regard that it was said to be impossible to follow Wigner through a door. He was light-hearted and fun-loving, but also devoted to his family and concerned about the future of the planet. This combination of exceptional skill and laudable humanity ensures Wigner’s place among the most highly regarded of his field.

(Taken from E. Vogt, *Phys. Today* **48** (12) (1995) 40–44.)



Eugene Paul Wigner
1902–1995

Define the new quantities

$$H_{\pm} \equiv \frac{1}{2}(W_1 \pm iW_2), \quad H_0 \equiv \frac{1}{2p}W_0$$

and the corresponding operators acting on the carrier space. From Eq. (30.27), it follows that $[\mathbf{W}_1, \mathbf{W}_2] = 0$, $\mathbf{W}^2 = -4\mathbf{H}_+\mathbf{H}_-$, and that

$$[\mathbf{H}_+, \mathbf{H}_0] = -\mathbf{H}_+, \quad [\mathbf{H}_+, \mathbf{H}_0] = \mathbf{H}_-, \quad [\mathbf{H}_+, \mathbf{H}_-] = 0.$$

Denote the eigenstates of \mathbf{W}^2 and \mathbf{H}_0 by $|\alpha, \beta\rangle$:

$$\mathbf{W}^2|\alpha, \beta\rangle = \alpha|\alpha, \beta\rangle, \quad \mathbf{H}_0|\alpha, \beta\rangle = \beta|\alpha, \beta\rangle.$$

Then the reader may check that $\mathbf{H}_{\pm}|\alpha, \beta\rangle$ has eigenvalues α and $\beta \pm 1$. By applying \mathbf{H}_{\pm} repeatedly, we can generate all eigenvalues of \mathbf{H}_0 and note that they are of the form

$$\beta = r + n, \quad \text{where } n = 0, \pm 1, \pm 2, \dots \text{ and } 1 > r \geq 0.$$

Since $\mathbf{H}_0 = \mathbf{M}_{23}$, \mathbf{H}_0 is recognized as an angular momentum operator whose eigenvalues are integer (for bosons) and half-odd integer (for fermions). Therefore, $r = 0$ for bosons and $r = \frac{1}{2}$ for fermions.

Now, within an irreducible representation, only those $|\alpha, \beta\rangle$'s can occur that have the same α . Therefore, if we relabel the β values by integers, then

$$\langle \alpha, n | \mathbf{H}_0 | \alpha, m \rangle = (r + n)\delta_{nm}.$$

Similarly,

$$\begin{aligned} \langle \alpha, n | \mathbf{H}_+ | \alpha, m \rangle &= a_n \delta_{n, m+1}, \\ \langle \alpha, n | \mathbf{H}_- | \alpha, m \rangle &= b_n \delta_{n, m-1}, \end{aligned}$$

where a_n and b_n are some constants. It follows that

$$\begin{aligned} \alpha &= \langle \alpha, n | \mathbf{W}^2 | \alpha, n \rangle = \langle \alpha, n | \mathbf{H}_+ \mathbf{H}_- | \alpha, n \rangle \\ &= \langle \alpha, n | \mathbf{H}_+ | \alpha, n-1 \rangle \langle \alpha, n-1 | \mathbf{H}_- | \alpha, n \rangle \\ &= a_n b_n. \end{aligned}$$

If we assume that the representation is unitary, then all \mathbf{W}_j 's will be hermitian, $(\mathbf{H}_+)^{\dagger} = \mathbf{H}_-$, so $a_n = b_n^*$ and $\alpha = |a_n|^2 \geq 0$.

If $\alpha = 0$, then $a_n = 0$ and $b_n = 0$ for all n . Consequently, $\mathbf{H}_+ = 0 = \mathbf{H}_-$, i.e., there are no raising or lowering operators. It follows that there are only two spin states, corresponding to the maximum and the minimum eigenvalues of \mathbf{H}_0 . A natural axis for the projection of spin is the direction of motion of the particle. Then the projection of spin is called **helicity**. We summarize our discussion in the following theorem.

helicity of massless particles

Theorem 30.3.12 *In the absence of any interactions, a massless relativistic particle is specified by its spin and its helicity. The former taking on integer or half-odd-integer values s , the latter having values $+s$ and $-s$.*

Theorems 30.3.11 and 30.3.12 are beautiful examples of the fruitfulness of the interplay between mathematics and physics. Physics has provided mathematics with a group, the Poincaré group, and mathematics, through its theory of group representation, has provided physics with the deep result that all particles must have a spin that takes on a specific value, and none other; that massive particles are allowed to have $2s + 1$ different values for the projection of their spin; and that massless particles are allowed to have only two values for their spin projection. Such far-reaching results that are both universal and specific makes physics unique among all other sciences. It also provides impetus for the development of mathematics as the only dialect through which nature seems to communicate to us her deepest secrets.

If $\alpha > 0$, then the resulting representations will have continuous spin variables. Such representations do not correspond to particles found in nature; therefore, we shall not pursue them any further.

30.4 Problems

30.1 Show that the operation on a compact group defined by

$$(u|v) \equiv \int_G \langle \mathbf{T}_g u | \mathbf{T}_g v \rangle d\mu_g$$

is an inner product.

30.2 Show that the Weyl operator \mathbf{K}_μ is hermitian.

30.3 Derive Eqs. (30.5) and (30.6). Hint: Follow the finite-group analogy.

30.4 Suppose that a Lie group G acts on a Euclidean space \mathbb{R}^n as well as on the space of (square-integrable) functions $\mathcal{L}(\mathbb{R}^n)$. Let $\phi_i^{(\alpha)}$ transform as the i th row of the α th irreducible representation. Verify that the relation

$$\mathbf{T}_g \phi_i^{(\alpha)}(\mathbf{x}) = \sum_{j=1}^{n_\alpha} T_{ji}^{(\alpha)}(g) \phi_j^{(\alpha)}(\mathbf{x} \cdot g^{-1})$$

defines a representation of G .

30.5 Show that $GL(\mathcal{V})$ is not a compact group. Hint: Find a continuous function $GL(\mathcal{V}) \rightarrow \mathbb{C}$ whose image is not compact.

30.6 Suppose that $T : G \rightarrow GL(\mathcal{V})$ is a representation, and let

$$\mathcal{V}^{\otimes r} \equiv \underbrace{\mathcal{V} \otimes \cdots \otimes \mathcal{V}}_{r \text{ times}}$$

be the r -fold tensor product of \mathcal{V} . Show that $T^{\otimes r} : G \rightarrow GL(\mathcal{V}^{\otimes r})$, given by

$$\mathbf{T}_g^{\otimes r}(\mathbf{v}_1, \dots, \mathbf{v}_r) = \mathbf{T}_g(\mathbf{v}_1) \otimes \cdots \otimes \mathbf{T}_g(\mathbf{v}_r),$$

is also a representation.

30.7 Suppose that in Example 30.2.2, we set $k_1 = 2$ for our treatment of $n = 2, r = 3$. Show that $\mathbf{Y}_2(\mathbf{e}_{k_1} \otimes \mathbf{e}_{k_2} \otimes \mathbf{e}_{k_3})$ does not produce any new vector beyond what we obtained for $k_1 = 1$.

30.8 Show that $g^{ij} g^{sr} c_{ikrs}$ is antisymmetric in j and r .

30.9 Operate \mathbf{L}_+ on

$$|00\rangle = \sum_{m=-l}^l C(l; 0|m, -m; 0) |lm; l, -m\rangle$$

and use $\mathbf{L}_+|00\rangle = 0$ to find a recursive relation among $C(l; 0|m, -m; 0)$. Use normalization and the convention that $C(l; 0|m, -m; 0) > 0$ to show that

$$C(l; 0|m, -m; 0) = (-1)^{l-m} / \sqrt{2l+1}$$

(see Sect. 13.3).

30.10 Show that the generators of $\mathfrak{so}(3, 1)$,

$$\mathbf{M} \equiv (M_1, M_2, M_3) \equiv (M_{23}, M_{31}, M_{12}),$$

$$\mathbf{N} \equiv (N_1, N_2, N_3) \equiv (M_{01}, M_{02}, M_{03}),$$

satisfy the commutation relations

$$[M_i, M_j] = -\epsilon_{ijk} M_k, \quad [N_i, N_j] = \epsilon_{ijk} M_k, \quad [M_i, N_j] = -\epsilon_{ijk} N_k,$$

and that $\mathbf{M}^2 - \mathbf{N}^2$ and $\mathbf{M} \cdot \mathbf{N}$ commute with all the M 's and the N 's.

30.11 Let the double-indexed “metric” of the Poincaré algebra be defined as

$$g_{ij,kl} = c_{ij,mn}^{rs} c_{kl,rs}^{mn} + c_{ij,m}^r c_{kl,r}^m,$$

where the structure constants are given in Eq. (30.21). Show that

$$g_{ij,kl} = 2(n-1)(\eta_{jk}\eta_{il} - \eta_{ik}\eta_{jl}).$$

30.12 Show that $[\mathbf{M}^2, \mathbf{M}^{ij}] = 0$, and

$$[\mathbf{M}^2, \mathbf{P}_k] = 4\mathbf{M}_{kj}\mathbf{P}^j + 2(n-1)\mathbf{P}_k.$$

30.13 Show that the vector operator

$$\mathbf{C}_i \equiv \mathbf{M}_{ij} \mathbf{P}^j = \eta^{kj} \mathbf{M}_{ij} \mathbf{P}_k$$

satisfies the following commutation relations:

$$\begin{aligned} [\mathbf{C}_i, \mathbf{P}_j] &= \eta_{ij} \mathbf{P}^2 - \mathbf{P}_i \mathbf{P}_j, & [\mathbf{C}_i, \mathbf{M}_{jk}] &= \eta_{ik} \mathbf{C}_j - \eta_{ij} \mathbf{C}_k, \\ [\mathbf{C}_i, \mathbf{C}_j] &= \mathbf{M}_{ij} \mathbf{P}^2. \end{aligned}$$

Show also that $[\mathbf{C}^2, \mathbf{M}_{jk}] = 0$, $\mathbf{C}^i \mathbf{P}_i = 0$, and

$$\mathbf{P}^i \mathbf{C}_i = -(n-1) \mathbf{P}^2, \quad [\mathbf{C}^2, \mathbf{P}_i] = \{2\mathbf{C}_i + (n-1)\mathbf{P}_i\} \mathbf{P}^2.$$

30.14 Derive Eq. (30.24) and show that $\mathbf{W}^{i_1 \dots i_{n-3}}$ commutes with all the \mathbf{P}_j 's.

30.15 Let $\hat{\mathbf{e}}_x \equiv (x_1, \dots, x_n)$ be any unit vector in \mathbb{R}^n .

- Show that a matrix is η -orthogonal, i.e., it satisfies Eq. (29.38), if and only if its columns are η -orthogonal.
- Show that there exists an $\mathbf{A} \in O(p, n-p)$ such that $\hat{\mathbf{e}}_x = \mathbf{A} \hat{\mathbf{e}}_1$ where $\hat{\mathbf{e}}_1 = (1, 0, \dots, 0)$. Hint: Find the first column of \mathbf{A} and use (a).
- Conclude that $O(p, n-p)$ is transitive in its action on the collection of all vectors of the same length.

30.16 Verify directly that when the 4-momentum has only a time component, the Casimir operator $\mathbf{W}^2 = \mathbf{W} \cdot \mathbf{W}$ reduces essentially to the total angular momentum operator.

30.17 Verify that for the case of a massless particle, when $\mathbf{p}_0 = (p, 0, 0, p)$,

$$W_0 = W_1 = M_{23}, \quad W_2 = 2p(M_{13} - M_{03}), \quad W_3 = 2p(M_{02} - M_{12}),$$

and that $\mathbf{W}^2 = \mathbf{W} \cdot \mathbf{W}$ annihilates $|\psi_{\mathbf{p}_0}\rangle$.

In Sect. 4.5, we discussed the representation of an algebra and its significance in physical applications. This significance is doubled in the case of the Clifford algebras because of their relation with the Dirac equation, which describes a relativistic spin- $\frac{1}{2}$ fundamental particle such as a lepton or a quark. With the representation of Lie groups and Lie algebras behind us, we can now tackle the important topic of the representation of Clifford algebras.

31.1 The Clifford Group

Let \mathcal{C}_V be a Clifford algebra. Denote by \mathcal{C}_V^\times the set of invertible elements of \mathcal{C}_V , which obviously form a group. Define a map $\text{ad} : \mathcal{C}_V^\times \rightarrow GL(\mathcal{C}_V)$ by

$$\text{ad}(\mathbf{a})\mathbf{x} = \omega_V(\mathbf{a}) \vee \mathbf{x} \vee \mathbf{a}^{-1}, \tag{31.1}$$

where ω_V is the degree involution of \mathcal{C}_V , and note that

$$\begin{aligned} \text{ad}(\mathbf{a}_1 \vee \mathbf{a}_2)\mathbf{x} &= \omega_V(\mathbf{a}_1 \vee \mathbf{a}_2) \vee \mathbf{x} \vee (\mathbf{a}_1 \vee \mathbf{a}_2)^{-1} \\ &= \omega_V(\mathbf{a}_1) \vee \underbrace{[\omega_V(\mathbf{a}_2) \vee \mathbf{x} \vee \mathbf{a}_2^{-1}]}_{=\text{ad}(\mathbf{a}_2)\mathbf{x} \equiv \mathbf{y} \in \mathcal{C}_V} \vee \mathbf{a}_1^{-1} \\ &= \omega_V(\mathbf{a}_1) \vee \mathbf{y} \vee \mathbf{a}_1^{-1} = \text{ad}(\mathbf{a}_1)\mathbf{y} = \text{ad}(\mathbf{a}_1) \text{ad}(\mathbf{a}_2)\mathbf{x}. \end{aligned}$$

It follows that $\text{ad}(\mathbf{a}_1 \vee \mathbf{a}_2) = \text{ad}(\mathbf{a}_1) \circ \text{ad}(\mathbf{a}_2)$, i.e., that ad is a group homomorphism, thus a group representation.

Definition 31.1.1 The representation defined in Eq. (31.1) is called the **twisted adjoint representation**.

twisted adjoint representation

As shown in Problem 31.1, two immediate consequences of Eq. (31.1) are

$$\text{ad}(\omega_V(\mathbf{a})) = \omega_V \circ \text{ad}(\mathbf{a}) \circ \omega_V \tag{31.2}$$

and

$$\text{ad}(\mathbf{y}) = \mathbf{R}_y = \mathbf{1} - 2\mathbf{y} \frac{1}{\mathbf{g}(\mathbf{y}, \mathbf{y})} \phi_y, \quad \mathbf{y} \in \mathcal{V} \cap \mathcal{C}_V^\times, \tag{31.3}$$

as in Eq. (26.35); i.e., that $\text{ad}(\mathbf{y})$ is a reflection operator in \mathcal{V} . Equation (31.2) follows from $\omega_V \circ \omega_V = \iota$, and (31.3) from Eq. (27.14).

Proposition 31.1.2 $\ker \text{ad} = \lambda \mathbf{1}$, where $0 \neq \lambda \in \mathbb{C}$.

Proof That $\lambda \mathbf{1} \in \ker \text{ad}$ is trivial to show. To prove the converse, assume that $\text{ad}(\mathbf{a}) = \iota$. Then $\text{ad}(\mathbf{a})\mathbf{x} = \iota\mathbf{x} = \mathbf{x}$, and therefore,

$$\mathbf{x} = \omega_V(\mathbf{a}) \vee \mathbf{x} \vee \mathbf{a}^{-1} \quad \text{or} \quad \omega_V(\mathbf{a}) \vee \mathbf{x} = \mathbf{x} \vee \mathbf{a}, \quad \text{for all } \mathbf{x} \in \mathcal{C}_V. \quad (31.4)$$

In particular, with $\mathbf{x} = \mathbf{1}$, we get $\omega_V(\mathbf{a}) = \mathbf{a}$. Substituting this back in (31.4) yields $\mathbf{a} \vee \mathbf{x} = \mathbf{x} \vee \mathbf{a}$ for all $\mathbf{x} \in \mathcal{C}_V$. This, together with $\omega_V(\mathbf{a}) = \mathbf{a}$ implies that $\mathbf{a} \in \mathcal{Z}_V^0$. It follows from Proposition 27.2.13 that $\mathbf{a} \in \text{Span}\{\mathbf{1}\}$ or $\mathbf{a} = \lambda \mathbf{1}$. Since \mathbf{a} is invertible, $\lambda \neq 0$. \square

Clifford group

Definition 31.1.3 Let Γ_V be the set of $\mathbf{a} \in \mathcal{C}_V^\times$ such that $\text{ad}(\mathbf{a})\mathbf{v} \in \mathcal{V}$ for all $\mathbf{v} \in \mathcal{V}$. Γ_V is a subgroup of \mathcal{C}_V^\times and is called the **Clifford group** of \mathcal{V} .

Clifford group of \mathbb{C}

Example 31.1.4 It is instructive to find the Clifford group of the simple example of complex numbers from first principles to get a handle on the more general case. We have $\mathcal{V} = \mathbb{R}$ and $\{\mathbf{1}, \mathbf{e}\}$ is a basis of the algebra.¹ In order to apply Eq. (31.1), we need \mathbf{a}^{-1} . Of course, we know from our knowledge of complex numbers what the inverse is. But, since we are starting from first principles, we find \mathbf{a}^{-1} from scratch.

Let $\mathbf{a} = \alpha \mathbf{1} + \beta \mathbf{e}$. We are looking for $\mathbf{a}' = \alpha' \mathbf{1} + \beta' \mathbf{e}$ such that $\mathbf{a}' \vee \mathbf{a} = \mathbf{1}$. This translates into

$$(\alpha \mathbf{1} + \beta \mathbf{e}) \vee (\alpha' \mathbf{1} + \beta' \mathbf{e}) = \mathbf{1},$$

or, since $\mathbf{e} \vee \mathbf{e} = -\mathbf{1}$, into

$$(\alpha \alpha' - \beta \beta') \mathbf{1} + (\alpha \beta' + \alpha' \beta) \mathbf{e} = \mathbf{1}.$$

It follows that $\alpha \alpha' - \beta \beta' = 1$ and $\alpha \beta' + \alpha' \beta = 0$. At least one of the components of \mathbf{a} , say α is nonzero. Hence, the second equation gives $\beta' = -\alpha' \beta / \alpha$. Substituting in the first equation, we get

$$\alpha \alpha' + \frac{\alpha' \beta^2}{\alpha} = 1 \quad \text{or} \quad \alpha' = \frac{\alpha}{\alpha^2 + \beta^2},$$

from which we obtain $\beta' = -\beta / (\alpha^2 + \beta^2)$, and

$$\mathbf{a}^{-1} = \frac{\alpha \mathbf{1} - \beta \mathbf{e}}{\alpha^2 + \beta^2},$$

¹We avoid using the normal notation for complex numbers to be more in tune with the notation of the Clifford algebras. So, instead of z , we use \mathbf{a} and instead of i we use \mathbf{e} .

a familiar result from complex number theory. The uniqueness of the inverse ensures that had we chosen β not to be zero, we would have obtained the same result.

Now we try to find the elements of Γ_V , which by definition are those which leave \mathcal{V} invariant. Let $\eta\mathbf{e}$ be an arbitrary element of \mathcal{V} and recall that $\omega_V(\mathbf{1}) = \mathbf{1}$ and $\omega_V(\mathbf{e}) = -\mathbf{e}$. Equation (31.1) now reads

$$(\alpha\mathbf{1} - \beta\mathbf{e}) \vee (\eta\mathbf{e}) \vee \left(\frac{\alpha\mathbf{1} - \beta\mathbf{e}}{\alpha^2 + \beta^2} \right),$$

which, after multiplying through, yields

$$\left(\frac{2\alpha\beta}{\alpha^2 + \beta^2} \mathbf{1} + \frac{\alpha^2 - \beta^2}{\alpha^2 + \beta^2} \mathbf{e} \right) \eta.$$

This will be in \mathcal{V} (i.e., \mathbf{a} will be in Γ_V) for all values of η if either $\alpha = 0$ or $\beta = 0$, i.e., if \mathbf{a} is real or pure imaginary.

Equation (31.3) shows that any non-null (or non-isotropic) $\mathbf{y} \in \mathcal{V}$ (i.e., a vector for which $\mathbf{g}(\mathbf{y}, \mathbf{y}) \neq 0$) is contained in the Clifford group of \mathcal{V} . We shall see later that Γ_V is indeed generated by such elements.

Proposition 31.1.5 Γ_V is stable under the two involutions ω_V and σ_V , and thus under the conjugation $\mathbf{a} \mapsto \bar{\mathbf{a}}$, where $\bar{\mathbf{a}} = \sigma_V \omega_V(\mathbf{a})$.

Proof Let $\mathbf{a} \in \Gamma_V$, i.e., $\text{ad}(\mathbf{a})\mathbf{x} \in \mathcal{V}$ if $\mathbf{x} \in \mathcal{V}$. Using (31.2), we have

$$\text{ad}(\omega_V \mathbf{a})\mathbf{x} = \omega_V \circ \text{ad}(\mathbf{a}) \circ \omega_V \mathbf{x} = -\omega_V \circ \text{ad}(\mathbf{a})\mathbf{x} = \text{ad}(\mathbf{a})\mathbf{x} \in \mathcal{V},$$

because $\omega_V \mathbf{v} = -\mathbf{v}$ for all $\mathbf{v} \in \mathcal{V}$. Hence, $\omega_V(\mathbf{a}) \in \Gamma_V$.

Next we show that $\sigma_V \mathbf{a} \in \Gamma_V$. We have

$$\text{ad}(\sigma_V \mathbf{a})\mathbf{x} = (\omega_V \sigma_V \mathbf{a}) \vee \mathbf{x} \vee (\sigma_V \mathbf{a})^{-1} = (\sigma_V \omega_V \mathbf{a}) \vee \mathbf{x} \vee (\sigma_V \mathbf{a}^{-1}),$$

where we used the fact that ω_V and σ_V commute and that $(\sigma_V \mathbf{a})^{-1} = \sigma_V(\mathbf{a}^{-1})$, which is true for all involutions. Since $\sigma_V \mathbf{x} = \mathbf{x}$, the right-hand side can be written as

$$\text{RHS} = (\sigma_V \omega_V \mathbf{a}) \vee \sigma_V \mathbf{x} \vee \sigma_V(\mathbf{a}^{-1}) = \sigma_V[\mathbf{a}^{-1} \vee \mathbf{x} \vee \omega_V \mathbf{a}],$$

using Eq. (27.22). But

$$\mathbf{a}^{-1} = \omega_V^2 \mathbf{a}^{-1} = \omega_V(\omega_V \mathbf{a}^{-1}) = \omega_V(\omega_V \mathbf{a})^{-1},$$

and denoting $(\omega_V \mathbf{a})^{-1}$ by $\mathbf{b} \in \Gamma_V$, we have

$$\text{RHS} = \sigma_V[\omega_V \mathbf{b} \vee \mathbf{x} \vee \mathbf{b}^{-1}] = \sigma_V[\text{ad}(\mathbf{b})\mathbf{x}] = \text{ad}(\mathbf{b})\mathbf{x} \in \mathcal{V}.$$

It follows that $\text{ad}(\sigma_V \mathbf{a})\mathbf{x} \in \mathcal{V}$, i.e., $\sigma_V \mathbf{a} \in \Gamma_V$. \square

We have defined conjugation for any element of \mathcal{C}_V . Our experience with complex and quaternion conjugation leads us to believe that $\mathbf{a} \vee \bar{\mathbf{a}}$ is a non-negative real number. This does not hold for general \mathbf{a} in a general Clifford algebra. However, we have the following:

Proposition 31.1.6 *Let $\theta : \mathbb{C}_V \rightarrow \mathbb{C}_V$ be defined by $\theta(\mathbf{a}) = \mathbf{a} \vee \bar{\mathbf{a}}$. If $\mathbf{a} \in \Gamma_V$, then*

$$\theta(\mathbf{a}) = \mathbf{a} \vee \bar{\mathbf{a}} = \lambda_a \mathbf{1}, \quad \lambda_a \neq 0.$$

Proof By Proposition 31.1.5, $\bar{\mathbf{a}} \in \Gamma_V$. Let \mathbf{x} be an arbitrary vector in \mathcal{V} , and set $\mathbf{y} = \text{ad}(\bar{\mathbf{a}})\mathbf{x}$. Then $\mathbf{y} \in \mathcal{V}$ and hence $\sigma_V \mathbf{y} = \mathbf{y}$. Spelling out this identity yields

$$\sigma_V(\omega_V(\bar{\mathbf{a}}) \vee \mathbf{x} \vee \bar{\mathbf{a}}^{-1}) = \omega_V(\bar{\mathbf{a}}) \vee \mathbf{x} \vee \bar{\mathbf{a}}^{-1}$$

or

$$\sigma_V(\bar{\mathbf{a}}^{-1}) \vee \mathbf{x} \vee \sigma_V(\omega_V \bar{\mathbf{a}}) = (\sigma_V \bar{\mathbf{a}})^{-1} \vee \mathbf{x} \vee \sigma_V(\omega_V \bar{\mathbf{a}}) = \omega_V(\bar{\mathbf{a}}) \vee \mathbf{x} \vee \bar{\mathbf{a}}^{-1}.$$

This yields

$$\mathbf{x} \vee \sigma_V(\omega_V \bar{\mathbf{a}}) \vee \bar{\mathbf{a}} = \sigma_V(\bar{\mathbf{a}}) \vee \omega_V(\bar{\mathbf{a}}) \vee \mathbf{x}.$$

From $\bar{\mathbf{a}} = \sigma_V \omega_V(\mathbf{a})$, the fact that σ_V and ω_V commute, and that both are involutions, we get

$$\sigma_V \omega_V(\bar{\mathbf{a}}) = \mathbf{a} \quad \text{and} \quad \sigma_V(\bar{\mathbf{a}}) = \omega_V(\mathbf{a}).$$

Using these in the previous equation yields

$$\mathbf{x} \vee \mathbf{a} \vee \bar{\mathbf{a}} = \omega_V(\mathbf{a} \vee \bar{\mathbf{a}}) \vee \mathbf{x}, \quad \mathbf{x} \in \mathcal{V}.$$

Thus, setting $\mathbf{b} = \mathbf{a} \vee \bar{\mathbf{a}}$, we have

$$\mathbf{x} \vee \mathbf{b} = \omega_V(\mathbf{b}) \vee \mathbf{x}, \quad \mathbf{x} \in \mathcal{V}.$$

Now write $\mathbf{b} = \mathbf{b}_0 + \mathbf{b}_1$, with $\mathbf{b}_0 \in \mathbb{C}_V^0$ and $\mathbf{b}_1 \in \mathbb{C}_V^1$. Then the equation above becomes

$$\mathbf{x} \vee \mathbf{b}_0 + \mathbf{x} \vee \mathbf{b}_1 = (\mathbf{b}_0 - \mathbf{b}_1) \vee \mathbf{x},$$

and setting the odd and even parts of both sides equal yields

$$\mathbf{x} \vee \mathbf{b}_0 = \mathbf{b}_0 \vee \mathbf{x} \quad \text{and} \quad \mathbf{x} \vee \mathbf{b}_1 = -\mathbf{b}_1 \vee \mathbf{x}, \quad \mathbf{x} \in \mathcal{V}.$$

Thus, $\mathbf{b}_0 \in \mathbb{Z}_V^0$ and $\mathbf{b}_1 \in \bar{\mathbb{Z}}_V^1$. From Propositions 27.2.10 and 27.2.13, we now conclude that $\mathbf{b}_0 = \lambda_a \mathbf{1}$ and $\mathbf{b}_1 = \mathbf{0}$ whence $\mathbf{b} = \mathbf{a} \vee \bar{\mathbf{a}} = \lambda_a \mathbf{1}$ and so $\theta(\mathbf{a}) = \lambda_a \mathbf{1}$. Finally, since \mathbf{a} is invertible, λ_a cannot be zero. \square

Clifford group of the quaternions

Example 31.1.7 In Example 31.1.4, we constructed the Clifford group of \mathbb{C} . Although the construction seemed trivial, it featured most of the procedure used in the general case. As a slightly more complicated example, let us find the Clifford group of \mathbb{H} , the quaternions. In this case, $\mathcal{V} = \mathbb{R}^2$ with basis $\{\mathbf{e}_1, \mathbf{e}_2\}$.

To simplify the writing, we sometimes remove the Clifford multiplication sign \vee , and use juxtaposition for product. We also use \mathbf{e}_{12} for $\mathbf{e}_1 \vee \mathbf{e}_2$, in which case the basis of \mathbb{H} is written as $\{\mathbf{1}, \mathbf{e}_1, \mathbf{e}_2, \mathbf{e}_{12}\}$, of which the first and the last are even under the degree involution ω_V , and the middle two, odd.

For $\mathbf{a} = \alpha_0 \mathbf{1} + \alpha_1 \mathbf{e}_1 + \alpha_2 \mathbf{e}_2 + \alpha_3 \mathbf{e}_{12}$, and $\mathbf{v} = \beta_1 \mathbf{e}_1 + \beta_2 \mathbf{e}_2$, Eq. (31.1) becomes

$$(\alpha_0 \mathbf{1} - \alpha_1 \mathbf{e}_1 - \alpha_2 \mathbf{e}_2 + \alpha_3 \mathbf{e}_{12})(\beta_1 \mathbf{e}_1 + \beta_2 \mathbf{e}_2) \frac{\alpha_0 \mathbf{1} - \alpha_1 \mathbf{e}_1 - \alpha_2 \mathbf{e}_2 - \alpha_3 \mathbf{e}_{12}}{\alpha_0^2 + \alpha_1^2 + \alpha_2^2 + \alpha_3^2},$$

where we used Example 3.1.16 to come up with \mathbf{a}^{-1} , although we could have calculated it—after a straightforward, but tedious labor—using a technique similar to the one used in Example 31.1.4. Using the notation $|\mathbf{a}|^2 \equiv \alpha_0^2 + \alpha_1^2 + \alpha_2^2 + \alpha_3^2$ and multiplying out the equation above (another tedious calculation), we obtain

$$\begin{aligned} \omega_V(\mathbf{a}) \vee \mathbf{v} \vee \mathbf{a}^{-1} &= \frac{2}{|\mathbf{a}|^2} [(\alpha_0 \alpha_1 + \alpha_2 \alpha_3) \beta_1 + (\alpha_0 \alpha_2 - \alpha_1 \alpha_3) \beta_2] \mathbf{1} \\ &\quad + [(\alpha_0^2 - \alpha_1^2 + \alpha_2^2 - \alpha_3^2) \beta_1 - 2(\alpha_1 \alpha_2 + \alpha_0 \alpha_3) \beta_2] \mathbf{e}_1 \\ &\quad + [2(\alpha_0 \alpha_3 - \alpha_1 \alpha_2) \beta_1 + (\alpha_0^2 + \alpha_1^2 - \alpha_2^2 - \alpha_3^2) \beta_2] \mathbf{e}_2. \end{aligned}$$

For this to be in \mathcal{V} for arbitrary \mathbf{v} , the coefficient of $\mathbf{1}$ must vanish for arbitrary β_1 and β_2 . This will happen iff

$$\alpha_0 \alpha_1 + \alpha_2 \alpha_3 = 0 \quad \text{and} \quad \alpha_0 \alpha_2 - \alpha_1 \alpha_3 = 0. \quad (31.5)$$

At least one of the α 's, say α_1 is not zero. Then $\alpha_0 = -\alpha_2 \alpha_3 / \alpha_1$ from the first equation, which upon substitution in the second equation of (31.5), yields $\alpha_3(\alpha_1^2 + \alpha_2^2) = 0$, whose only solution is $\alpha_3 = 0$, and so $\alpha_0 = 0$ as well. If we assume that α_0 is not zero, the solution will be $\alpha_1 = 0 = \alpha_2$. Hence, Γ_V consists of algebra members of the form

$$\mathbf{a}_1 = \alpha_1 \mathbf{e}_1 + \alpha_2 \mathbf{e}_2 \quad \text{or} \quad \mathbf{a}_2 = \alpha_0 \mathbf{1} + \alpha_3 \mathbf{e}_{12}.$$

Note that $\omega_V(\mathbf{a}_1) = -\mathbf{a}_1$, while $\omega_V(\mathbf{a}_2) = \mathbf{a}_2$. This even-oddness was also true for the two choices of Example 31.1.4.

Corollary 31.1.8 *The map θ of Proposition 31.1.6 satisfies*

$$\theta(\omega \mathbf{a}) = \theta(\mathbf{a}), \quad \mathbf{a} \in \Gamma_V.$$

Proof See Problem 31.2. □

Proposition 31.1.9 *The map $\lambda_V : \Gamma_V \rightarrow \mathbb{C}^\times$ given by $\lambda_V(\mathbf{a}) = \lambda_a$ is a homomorphism from the Clifford group to \mathbb{C}^\times (the multiplicative group of complex numbers).*

Proof To prove the homomorphism of λ_V , note that on the one hand, $\theta(\mathbf{a} \vee \mathbf{b}) = \lambda_V(\mathbf{a} \vee \mathbf{b}) \mathbf{1}$. On the other hand,

$$\begin{aligned} \theta(\mathbf{a} \vee \mathbf{b}) &= \mathbf{a} \vee \mathbf{b} \vee \overline{\mathbf{a} \vee \mathbf{b}} = \mathbf{a} \vee (\mathbf{b} \vee \bar{\mathbf{b}}) \vee \bar{\mathbf{a}} \\ &= \mathbf{a} \vee (\lambda_V(\mathbf{b}) \mathbf{1}) \vee \bar{\mathbf{a}} = \mathbf{a} \vee \bar{\mathbf{a}} \vee (\lambda_V(\mathbf{b}) \mathbf{1}) \\ &= (\lambda_V(\mathbf{a}) \mathbf{1}) \vee (\lambda_V(\mathbf{b}) \mathbf{1}) = \lambda_V(\mathbf{a}) \lambda_V(\mathbf{b}) \mathbf{1}. \end{aligned}$$

It follows that

$$\lambda_V(\mathbf{a} \vee \mathbf{b}) = \lambda_V(\mathbf{a})\lambda_V(\mathbf{b}),$$

i.e., that λ_V is a homomorphism. \square

Corollary 31.1.10 For $0 \neq \beta \in \mathbb{C}$ and $\mathbf{a} \in \Gamma_V$, the homomorphism λ_V of Proposition 31.1.9 satisfies

1. $\lambda_V(\beta\mathbf{a}) = \beta^2\lambda_V(\mathbf{a})$.
2. $\lambda_V(\omega\mathbf{a}) = \lambda_V(\mathbf{a})$.
3. $\lambda_V(\text{ad}(\mathbf{b})\mathbf{a}) = \lambda_V(\mathbf{a})$.

Proof The second relation follows from Corollary 31.1.8. The proof of the first and third relations is left as Problem 31.3. \square

Equation (31.3) shows that $\text{ad}(\mathbf{y})$ is the reflection operator in the plane normal to \mathbf{y} and, therefore, an isometry. Is $\text{ad}(\mathbf{a})$ an isometry for general \mathbf{a} ? The answer is yes, if \mathbf{a} is restricted to the Clifford group.

Proposition 31.1.11 Fix $\mathbf{a} \in \Gamma_V$ and let τ_a be the restriction of $\text{ad}(\mathbf{a})$ to \mathcal{V} . Then τ_a is an isometry of \mathcal{V} .

Proof Since $\bar{\mathbf{x}} = -\mathbf{x}$ for $\mathbf{x} \in \mathcal{V}$, Eq. (27.14) gives

$$\theta(\mathbf{x}) = -\mathbf{g}(\mathbf{x}, \mathbf{x})\mathbf{1},$$

from which it follows that

$$\lambda_V(\mathbf{x}) = -\mathbf{g}(\mathbf{x}, \mathbf{x}). \quad (31.6)$$

Now, the second relation in Corollary 31.1.10 yields

$$\mathbf{g}(\tau_a\mathbf{x}, \tau_a\mathbf{x}) = \mathbf{g}(\text{ad}(\mathbf{a})\mathbf{x}, \text{ad}(\mathbf{a})\mathbf{x}) = -\lambda_V(\text{ad}(\mathbf{a})\mathbf{x}) = -\lambda_V(\mathbf{x}) = \mathbf{g}(\mathbf{x}, \mathbf{x}),$$

showing that τ_a is an isometry of \mathcal{V} . \square

Since ad is a representation, we can establish a group homomorphism between Γ_V and $O(\mathcal{V})$, the group of isometries of \mathcal{V} . In fact, we have the following:

Proposition 31.1.12 Let $\Phi_V : \Gamma_V \rightarrow O(\mathcal{V})$ be defined by $\Phi_V(\mathbf{a}) = \tau_a$. Then Φ_V is a surjective homomorphism.

Proof That Φ_V is a homomorphism is immediate. By Theorem 26.5.17, every isometry is a product of reflections. Therefore, surjection is proved if we can show that for any reflection in $O(\mathcal{V})$, there is an element in Γ_V which is mapped by Φ_V to that reflection. But any reflection \mathbf{R}_y in \mathcal{V} is

just $\text{ad}(\mathbf{y})$ with \mathbf{y} being non-null, as observed in (31.3). Therefore, $\Phi_V(\mathbf{y}) = \tau_{\mathbf{y}} = \mathbf{R}_{\mathbf{y}}$, proving that Φ_V is surjective. \square

Theorem 31.1.13 *The Clifford group Γ_V is generated by non-null vectors $\mathbf{y} \in \mathcal{V}$.*

Proof Let $\mathbf{a} \in \Gamma_V$ and set $\tau = \Phi_V(\mathbf{a})$. By Theorem 26.5.17 and the fact that $\tau_{\mathbf{y}} = \mathbf{R}_{\mathbf{y}}$ for $\mathbf{y} \in \mathcal{V}$,

$$\tau = \mathbf{R}_{\mathbf{y}_1} \circ \cdots \circ \mathbf{R}_{\mathbf{y}_r} = \tau_{\mathbf{y}_1} \circ \cdots \circ \tau_{\mathbf{y}_r} = \Phi_V(\mathbf{y}_1 \vee \cdots \vee \mathbf{y}_r), \quad \mathbf{y}_i \in \mathcal{V}$$

where $\mathbf{g}(\mathbf{y}_i, \mathbf{y}_i) \neq 0$. It follows that

$$\Phi_V(\mathbf{a}^{-1} \vee \mathbf{y}_1 \vee \cdots \vee \mathbf{y}_r) = \tau^{-1} \tau = \iota.$$

But $\Phi_V(\mathbf{b}) = \text{ad}(\mathbf{b})$. Hence, by Proposition 31.1.2,

$$\mathbf{a}^{-1} \vee \mathbf{y}_1 \vee \cdots \vee \mathbf{y}_r = \lambda \mathbf{1}, \quad \lambda \neq 0$$

and

$$\mathbf{a} = (\lambda^{-1} \mathbf{y}_1) \vee \mathbf{y}_2 \vee \cdots \vee \mathbf{y}_r, \quad \mathbf{y}_i \in \mathcal{V}.$$

This completes the proof. \square

Example 31.1.14 Example 31.1.7 showed that the elements of Γ_V for quaternions were of two kinds:

$$\mathbf{a}_1 = \alpha_1 \mathbf{e}_1 + \alpha_2 \mathbf{e}_2 \quad \text{or} \quad \mathbf{a}_2 = \alpha_0 \mathbf{1} + \alpha_3 \mathbf{e}_3.$$

The first one is already in \mathbb{R}^2 . To show that the second one is generated by vectors in \mathbb{R}^2 , take two vectors $\mathbf{u} = \eta_1 \mathbf{e}_1 + \eta_2 \mathbf{e}_2$ and $\mathbf{v} = \xi_1 \mathbf{e}_1 + \xi_2 \mathbf{e}_2$ and note that

$$\mathbf{u} \vee \mathbf{v} = -(\eta_1 \xi_1 + \eta_2 \xi_2) \mathbf{1} + (\eta_1 \xi_2 - \eta_2 \xi_1) \mathbf{e}_{12}.$$

We want this to be equal to \mathbf{a}_2 . For that to happen, we should have

$$\eta_1 \xi_1 + \eta_2 \xi_2 = -\alpha_0$$

$$\eta_1 \xi_2 - \eta_2 \xi_1 = \alpha_3.$$

Clearly, there are infinitely many solutions. One simple solution is $\eta_1 = 1$, $\eta_2 = 0$, $\xi_1 = -\alpha_0$, and $\xi_2 = \alpha_3$. Then

$$\mathbf{u} = \mathbf{e}_1 \quad \text{and} \quad \mathbf{v} = -\alpha_0 \mathbf{e}_1 + \alpha_3 \mathbf{e}_2$$

are a pair of desired vectors.

Corollary 31.1.15 *The homomorphism Φ_V satisfies*

$$\det \Phi_V(\mathbf{a}) \cdot \mathbf{a} = \omega_V(\mathbf{a}), \quad \mathbf{a} \in \Gamma_V.$$

Proof Define the map $\phi : \Gamma_V \rightarrow \Gamma_V$ given by $\phi(\mathbf{a}) = \det \Phi_V(\mathbf{a}) \cdot \mathbf{a}$. It is not difficult to show that ϕ is a homomorphism and $\phi(\mathbf{x}) = \omega_V(\mathbf{x})$ for $\mathbf{x} \in \mathcal{V}$. Now apply Theorem 31.1.13. The details are left for Problem 31.4. \square

Example 31.1.16 In this example, we find τ_{a_1} and τ_{a_2} associated with the elements of Γ_V for \mathbb{H} as calculated in Example 31.1.7. For $\mathbf{x} = \xi_1 \mathbf{e}_1 + \xi_2 \mathbf{e}_2$, we have

$$\begin{aligned} \tau_{a_1} \mathbf{x} &= \text{ad}(\mathbf{a}_1) \mathbf{x} = \omega_V(\mathbf{a}_1) \vee \mathbf{x} \vee \mathbf{a}_1^{-1} = -\mathbf{a}_1 \vee \mathbf{x} \vee \mathbf{a}_1^{-1} \\ &= -(\alpha_1 \mathbf{e}_1 + \alpha_2 \mathbf{e}_2)(\xi_1 \mathbf{e}_1 + \xi_2 \mathbf{e}_2) \left(\frac{-\alpha_1 \mathbf{e}_1 - \alpha_2 \mathbf{e}_2}{\alpha_1^2 + \alpha_2^2} \right) \\ &= \frac{1}{\alpha_1^2 + \alpha_2^2} [-(\alpha_1^2 \xi_1 + 2\alpha_1 \alpha_2 \xi_2 - \alpha_2^2 \xi_1) \mathbf{e}_1 \\ &\quad + (\alpha_1^2 \xi_2 - 2\alpha_1 \alpha_2 \xi_1 - \alpha_2^2 \xi_2) \mathbf{e}_2]. \end{aligned} \quad (31.7)$$

If we represent \mathbf{x} as a column vector, i.e., if we represent \mathbf{e}_1 and \mathbf{e}_2 by

$$\mathbf{e}_1 = \begin{pmatrix} 1 \\ 0 \end{pmatrix} \quad \text{and} \quad \mathbf{e}_2 = \begin{pmatrix} 0 \\ 1 \end{pmatrix},$$

then τ_{a_1} can be represented as a 2×2 matrix whose entries can be read off from the two last lines of Eq. (31.7):

$$\tau_{a_1} = \begin{pmatrix} \frac{\alpha_1^2 - \alpha_2^2}{\alpha_1^2 + \alpha_2^2} & -\frac{2\alpha_1 \alpha_2}{\alpha_1^2 + \alpha_2^2} \\ -\frac{2\alpha_1 \alpha_2}{\alpha_1^2 + \alpha_2^2} & \frac{\alpha_1^2 - \alpha_2^2}{\alpha_1^2 + \alpha_2^2} \end{pmatrix}.$$

Similarly,

$$\tau_{a_2} \mathbf{x} = (\alpha_0 \mathbf{1} + \alpha_3 \mathbf{e}_{12})(\xi_1 \mathbf{e}_1 + \xi_2 \mathbf{e}_2) \left(\frac{\alpha_0 \mathbf{1} - \alpha_3 \mathbf{e}_{12}}{\alpha_0^2 + \alpha_3^2} \right),$$

from which we obtain

$$\tau_{a_2} = \begin{pmatrix} \frac{\alpha_0^2 - \alpha_3^2}{\alpha_0^2 + \alpha_3^2} & -\frac{2\alpha_0 \alpha_3}{\alpha_0^2 + \alpha_3^2} \\ \frac{2\alpha_0 \alpha_3}{\alpha_0^2 + \alpha_3^2} & \frac{\alpha_0^2 - \alpha_3^2}{\alpha_0^2 + \alpha_3^2} \end{pmatrix}.$$

It is straightforward to show that $\det \tau_{a_1} = -1$ and $\det \tau_{a_2} = 1$. This, together with $\omega_V(\mathbf{a}_1) = -\mathbf{a}_1$ and $\omega_V(\mathbf{a}_2) = \mathbf{a}_2$, verifies the assertion of Corollary 31.1.15.

31.2 Spinors

We now return to the Clifford algebra $C_\mu^v(\mathbb{R})$. In order not to clutter subscripts and superscripts, we shall sometimes use the notation $C(\mu, v)$ instead of $C_\mu^v(\mathbb{R})$, it being understood that the underlying field is \mathbb{R} . Let $\mathcal{V} = \mathbb{R}_v^n$ and denote by $\Gamma(\mu, v)$ the Clifford group of \mathbb{R}_v^n . Recall from Proposition 31.1.9 the homomorphism $\lambda_V : \Gamma(\mu, v) \rightarrow \mathbb{R}^\times$. Obviously $\ker \lambda_V = \{\mathbf{a} \in \Gamma(\mu, v) \mid \lambda_V(\mathbf{a}) = 1\}$ is a subgroup of $\Gamma(\mu, v)$. It turns out that, for applications in physics, a larger subgroup is more appropriate.

We are denoting $C_\mu^v(\mathbb{R})$ by $C(\mu, v)$ and using both notations interchangeably.

Definition 31.2.1 The group $\mathbf{Pin}(\mu, v)$ is the subgroup of $\Gamma(\mu, v)$ consisting of elements \mathbf{a} satisfying $\lambda_V(\mathbf{a}) = \pm 1$.

The group $\mathbf{Pin}(\mu, v)$

Clearly, $\ker \lambda_V \subset \mathbf{Pin}(\mu, v)$, so $\mathbf{1} \in \mathbf{Pin}(\mu, v)$, as it should. Now let \mathbf{x} be any non-null vector in \mathcal{V} . Then

$$\begin{aligned} \lambda_V(-\mathbf{1}) &= \lambda_V\left(-\frac{\mathbf{x} \vee \mathbf{x}}{\mathbf{g}(\mathbf{x}, \mathbf{x})}\right) = \left(-\frac{1}{\mathbf{g}(\mathbf{x}, \mathbf{x})}\right)^2 \lambda_V(\mathbf{x} \vee \mathbf{x}) \\ &= \left(-\frac{\lambda_V(\mathbf{x})}{\mathbf{g}(\mathbf{x}, \mathbf{x})}\right)^2 = 1, \end{aligned}$$

where we used the first relation of Corollary 31.1.10 and Eq. (31.6). Therefore, $-\mathbf{1}$ is contained in the kernel of λ_V and thus also in $\mathbf{Pin}(\mu, v)$.

From Eq. (31.6) it follows that all vectors $\mathbf{x} \in \mathcal{V}$ for which $\mathbf{g}(\mathbf{x}, \mathbf{x}) = \pm 1$ are contained in $\mathbf{Pin}(\mu, v)$. Theorem 31.1.13 and the fact that λ_V is a homomorphism, gives

Proposition 31.2.2 *The group $\mathbf{Pin}(\mu, v)$ is generated by $\mathbf{x} \in \mathcal{V}$ for which $\mathbf{g}(\mathbf{x}, \mathbf{x}) = \pm 1$.*

Let $O(\mu, v)$ be the group of isometries of \mathbb{R}_v^n and consider the homomorphism $\Phi_V : \Gamma(\mu, v) \rightarrow O(\mu, v)$ introduced in Proposition 31.1.12. Let Φ denote the restriction of Φ_V to $\mathbf{Pin}(\mu, v)$. Since Φ_V is surjective, for any $\tau \in O(\mu, v)$, there exists $\mathbf{b} \in \Gamma(\mu, v)$ such that $\Phi_V(\mathbf{b}) = \tau$. Now let

$$\mathbf{a} = \frac{\mathbf{b}}{\sqrt{|\lambda_V(\mathbf{b})|}}$$

and use the first relation of Corollary 31.1.10 to obtain

$$\lambda_V(\mathbf{a}) = \frac{\lambda_V(\mathbf{b})}{|\lambda_V(\mathbf{b})|} = \pm 1.$$

This shows that $\mathbf{a} \in \mathbf{Pin}(\mu, v)$. Moreover, since $\text{ad}(\mathbf{a}) = \text{ad}(\beta\mathbf{a})$ for any $\beta \in \mathbb{R}^\times$ (a fact that follows immediately from the definition of the twisted adjoint representation), we have $\Phi(\mathbf{a}) = \Phi_V(\mathbf{a}) = \Phi_V(\mathbf{b}) = \tau$.

The equality $\Phi(\mathbf{a}) = \text{ad}(\mathbf{a})$ along with Proposition 31.1.2 implies that $\mathbf{a} \in \ker \Phi$ if and only if $\mathbf{a} = \lambda\mathbf{1}$. The first relation of Corollary 31.1.10 gives $\lambda_V(\mathbf{a}) = \lambda^2$. Since $\mathbf{a} \in \mathbf{Pin}(\mu, v)$, we must have $|\lambda_V(\mathbf{a})| = 1$, or $\lambda = \pm 1$ and $\mathbf{a} = \pm\mathbf{1}$. The discussion above leads to

The group $\mathbf{Spin}(\mu, \nu)$

Theorem 31.2.3 *The map $\Phi : \mathbf{Pin}(\mu, \nu) \rightarrow O(\mu, \nu)$ defined by $\Phi(\mathbf{a}) = \tau_a$ is a surjective group homomorphism with $\ker \Phi = \{\mathbf{1}, -\mathbf{1}\}$.*

Definition 31.2.4 The even elements of $\mathbf{Pin}(\mu, \nu)$ form a group denoted by $\mathbf{Spin}(\mu, \nu)$. In other words,

$$\mathbf{Spin}(\mu, \nu) = \mathbf{Pin}(\mu, \nu) \cap \mathbf{C}^0(\mu, \nu).$$

Since $\omega_V(\mathbf{a}) = \mathbf{a}$ for $\mathbf{a} \in \mathbf{Spin}(\mu, \nu)$, Corollary 31.1.15 implies

Proposition 31.2.5 *Any $\mathbf{a} \in \Gamma(\mu, \nu)$ is in $\mathbf{Spin}(\mu, \nu)$ iff $\det \Phi_V(\mathbf{a}) = 1$.*

The surjective homomorphism $\Phi : \mathbf{Pin}(\mu, \nu) \rightarrow O(\mu, \nu)$ restricts to another homomorphism $\Psi : \mathbf{Spin}(\mu, \nu) \rightarrow SO(\mu, \nu)$:

Theorem 31.2.6 *The map $\Psi : \mathbf{Spin}(\mu, \nu) \rightarrow SO(\mu, \nu)$ defined by $\Psi(\mathbf{a}) = \tau_a$ is a surjective group homomorphism. Furthermore, $\ker \Psi = \{\mathbf{1}, -\mathbf{1}\}$.*

Example 31.2.7 We showed in Example 27.4.2 that $\mathbb{H} = \mathbf{C}(0, 2)$. Thus, with the new notation, we can write

$$\Gamma(0, 2) = \{\mathbf{a}_1, \mathbf{a}_2\} = \{\alpha_1 \mathbf{e}_1 + \alpha_2 \mathbf{e}_2, \alpha_0 \mathbf{1} + \alpha_3 \mathbf{e}_{12}\}.$$

We now want to find λ_{a_1} and λ_{a_2} . From the definition of θ of Proposition 31.1.6, we obtain

$$\lambda_{a_1} \mathbf{1} = \theta(\mathbf{a}_1) = \mathbf{a}_1 \vee \bar{\mathbf{a}}_1 = (\alpha_1 \mathbf{e}_1 + \alpha_2 \mathbf{e}_2)(-\alpha_1 \mathbf{e}_1 - \alpha_2 \mathbf{e}_2) = (\alpha_1^2 + \alpha_2^2) \mathbf{1}.$$

It follows that $\lambda_{a_1} = \alpha_1^2 + \alpha_2^2$. Similarly, $\lambda_{a_2} = \alpha_0^2 + \alpha_3^2$.

If we divide \mathbf{a}_i by its length $\sqrt{|\lambda_{a_i}|}$, we obtain the elements of $\mathbf{Pin}(0, 2)$. These are

$$\mathbf{b}_1 = \frac{\mathbf{a}_1}{\sqrt{|\lambda_{a_1}|}} = \frac{\alpha_1 \mathbf{e}_1 + \alpha_2 \mathbf{e}_2}{\sqrt{\alpha_1^2 + \alpha_2^2}} \quad \text{with } \lambda_{b_1} = 1,$$

$$\mathbf{b}_2 = \frac{\mathbf{a}_2}{\sqrt{|\lambda_{a_2}|}} = \frac{\alpha_0 \mathbf{1} + \alpha_3 \mathbf{e}_{12}}{\sqrt{\alpha_0^2 + \alpha_3^2}} \quad \text{with } \lambda_{b_2} = 1.$$

$\mathbf{Spin}(0, 2) = U(1)$ The group $\mathbf{Spin}(0, 2)$ consists of just \mathbf{b}_2 since that is the only even element of $\mathbf{Pin}(0, 2)$. Those quaternions that are a linear combination of $\mathbf{1}$ and only one of the other three basis elements can be identified with \mathbb{C} . We therefore conclude that $\mathbf{Spin}(0, 2)$ is the set of complex numbers of unit length, i.e., $\mathbf{Spin}(0, 2) = U(1) = \{e^{i\varphi} \mid \varphi \in \mathbb{R}\}$.

31.2.1 Pauli Spin Matrices and Spinors

We have already seen the connection between the Dirac equation of the relativistic electron and Clifford algebras. We have also mentioned how the Dirac equation predicted the existence of the positron through the identification of two of the four components of the solution to the equation with the spin of the positron. The idea of spin came out very naturally from the Dirac equation. However, the concept was there before. Pauli had already developed (albeit in an ad hoc way) the theory of a spinning electron in non-relativistic quantum physics. He had represented the electron by a 2-column vector with complex entries, a spinor, to account for the two states (up and down) of an electron spin, and introduced certain 2×2 matrices—now bearing his name—in the equations that described the behavior of the electron in magnetic fields. In the following, we use Pauli's matrices and spinors to motivate generalization to Clifford algebras.

The fact that we are dealing with a complex 2-column points to the total matrix algebra $\mathcal{M}_2(\mathbb{C})$, which is isomorphic to $\mathbf{C}_3^0(\mathbb{R})$ as Table 27.2 shows. The generators of $\mathbf{C}_3^0(\mathbb{R})$ are the basis vectors \mathbf{e}_1 , \mathbf{e}_2 , and \mathbf{e}_3 in \mathbb{R}^3 , obeying the multiplication rule

$$\mathbf{e}_i \vee \mathbf{e}_j + \mathbf{e}_j \vee \mathbf{e}_i \equiv \mathbf{e}_i \mathbf{e}_j + \mathbf{e}_j \mathbf{e}_i \equiv \mathbf{e}_{ij} + \mathbf{e}_{ji} = 2\delta_{ij} \mathbf{1}.$$

It is therefore instructive to find three 2×2 matrices which represent \mathbf{e}_1 , \mathbf{e}_2 , and \mathbf{e}_3 , and therefore, obey the same rule.

Referring to Eq. (27.25) and Example 27.2.6 with $\mathbf{v} = (\alpha, \beta, \gamma)$, we want to find a relation of the form

$$\begin{pmatrix} \alpha_{11} & \alpha_{12} \\ \alpha_{21} & \alpha_{22} \end{pmatrix} \begin{pmatrix} \alpha_{11} & \alpha_{12} \\ \alpha_{21} & \alpha_{22} \end{pmatrix} = (\alpha^2 + \beta^2 + \gamma^2) \begin{pmatrix} 1 & 0 \\ 0 & 1 \end{pmatrix},$$

where α_{ij} are now complex numbers. Inspired by the solution in Eq. (27.27), we try

$$\varphi(\alpha, \beta, \gamma) = \begin{pmatrix} \alpha & \beta - i\gamma \\ \beta + i\gamma & -\alpha \end{pmatrix} \quad (31.8)$$

and verify that indeed

$$\begin{pmatrix} \alpha & \beta - i\gamma \\ \beta + i\gamma & -\alpha \end{pmatrix} \begin{pmatrix} \alpha & \beta - i\gamma \\ \beta + i\gamma & -\alpha \end{pmatrix} = (\alpha^2 + \beta^2 + \gamma^2) \begin{pmatrix} 1 & 0 \\ 0 & 1 \end{pmatrix}.$$

For the basis vectors, Eq. (31.8) yields

$$\begin{aligned} \varphi(1, 0, 0) &= \begin{pmatrix} 1 & 0 \\ 0 & -1 \end{pmatrix}, & \varphi(0, 1, 0) &= \begin{pmatrix} 0 & 1 \\ 1 & 0 \end{pmatrix}, \\ \varphi(0, 0, 1) &= \begin{pmatrix} 0 & -i \\ i & 0 \end{pmatrix}, \end{aligned} \quad (31.9)$$

which are the three Pauli spin matrices used in the non-relativistic quantum physics of electrons.

One of the consequences of an isomorphism between two algebras is the equality of their dimensions. We know that the dimension of $\mathbf{C}_3^0(\mathbb{R})$ is 8. In fact, a basis is given by

$$\{\mathbf{1}, \mathbf{e}_1, \mathbf{e}_2, \mathbf{e}_3, \mathbf{e}_{12}, \mathbf{e}_{12}, \mathbf{e}_{23}, \mathbf{e}_{123}\}. \quad (31.10)$$

Labeling the three matrices of Eq. (31.9) by $\sigma_1, \sigma_2, \sigma_3$, respectively, we note that²

$$\sigma_1\sigma_2 = i\sigma_3, \quad \sigma_1\sigma_3 = -i\sigma_2, \quad \sigma_2\sigma_3 = i\sigma_1, \quad \sigma_1\sigma_2\sigma_3 = i\mathbf{1}.$$

Hence, as a real algebra, the matrices

$$\{\mathbf{1}, \sigma_1, \sigma_2, \sigma_3, i\mathbf{1}, i\sigma_1, i\sigma_2, i\sigma_3\}$$

form a basis of $\mathcal{M}_2(\mathbb{C})$, as the reader can verify directly by taking a linear combination of them with *real* coefficients, setting it equal to the zero 2×2 matrix, and showing that all coefficients are zero.

Pauli spin matrices are matrices! And Chap. 30 showed us that matrices have a very rich Lie group and Lie algebra structures. It is therefore natural to see if there is any relation between the Clifford algebra $\mathbf{C}_3^0(\mathbb{R})$ and a Lie algebra, and whether this relation can be extended to the associated Lie group and Clifford group.

First note that from the Clifford product $\sigma_i\sigma_j + \sigma_j\sigma_i = 2\delta_{ij}\mathbf{1}$, we obtain the Lie product

$$\sigma_1 \bullet \sigma_2 \equiv [\sigma_1, \sigma_2] = \sigma_1\sigma_2 - \sigma_2\sigma_1 = 2\sigma_1\sigma_2 = 2i\sigma_3,$$

plus cyclic permutation of the indices, which can be concisely written as

$$[\sigma_j, \sigma_k] = 2i\epsilon_{jkl}\sigma_l.$$

Now define the matrices $\mathfrak{s}_j = -i\sigma_j/2$ and note that

$$[\mathfrak{s}_j, \mathfrak{s}_k] = \epsilon_{jkl}\mathfrak{s}_l. \quad (31.11)$$

We thus have two kinds of connection. On the one hand, the three \mathfrak{s}_j being traceless and anti-hermitian, are connected to the Lie algebra $\mathfrak{su}(2)$ of Box 29.1.20. Therefore, the Lie group obtained by exponentiating the \mathfrak{s}_j is connected to the Lie group $SU(2)$. On the other hand, Problem 31.6 tells us that $\mathbf{Spin}(3, 0) \cong SU(2)$. It therefore appears that the Clifford algebra $\mathbf{C}_3^0(\mathbb{R})$ is related to the group $\mathbf{Spin}(3, 0)$ in the same way that the Lie algebra $\mathfrak{su}(2)$ is related to the Lie group $SU(2)$. The relation is further confirmed by the commutation relations between the components of angular momentum, which are the generators of the rotation group in three dimensions, i.e., $SO(3)$. The commutation relations are given in Example 29.1.35, and they are identical to those in Eq. (31.11). Hence, there seems to be the following chain of isomorphisms:

$$\mathbf{Spin}(3, 0) \cong SO(3) \cong SU(2).$$

²In physics literature, the matrices are actually labeled as $\sigma_3, \sigma_1, \sigma_2$, respectively.

The first link³ simply confirms Theorem 31.2.6.

As mentioned earlier, the electron, due to its spin, is represented by a 2-column with complex entries. These are vectors on which Pauli spin matrices act. How is this translated into the Clifford algebra $\mathbf{C}_3^0(\mathbb{R})$? Recall from Theorem 3.3.1 that the minimal left ideals of the total matrix algebra are matrices with only one column nonzero, and that they are generated by a matrix with only one nonzero entry in that column. Thus, the first step is to identify the 2-column as the first column of a 2×2 matrix:⁴

$$\begin{pmatrix} \psi_1 \\ \psi_2 \end{pmatrix} \sim \begin{pmatrix} \psi_1 & 0 \\ \psi_2 & 0 \end{pmatrix}.$$

Let \mathcal{S} stand for the minimal left ideal generated by \mathbf{P} , a 2×2 matrix with a 1 at the first position and zeros everywhere else:

$$\mathcal{S} = \mathcal{M}_2(\mathbb{C}) \begin{pmatrix} 1 & 0 \\ 0 & 0 \end{pmatrix} \cong \mathbf{C}_3^0(\mathbb{R})\mathbf{P}.$$

Using the common convention of labeling the Pauli spin matrices and identifying $\mathbf{C}_3^0(\mathbb{R})$ with $\mathcal{M}_2(\mathbb{C})$, we write

$$\mathbf{e}_1 \cong \sigma_1 = \begin{pmatrix} 0 & 1 \\ 1 & 0 \end{pmatrix}, \quad \mathbf{e}_2 \cong \sigma_2 = \begin{pmatrix} 0 & -i \\ i & 0 \end{pmatrix}, \quad \mathbf{e}_3 \cong \sigma_3 = \begin{pmatrix} 1 & 0 \\ 0 & -1 \end{pmatrix}.$$

Then

$$\mathbf{P} = \frac{1}{2}(\mathbf{1} + \mathbf{e}_3) \quad \text{and} \quad \mathbf{P}^2 = \mathbf{P},$$

i.e., \mathbf{P} is a (primitive) idempotent of $\mathbf{C}_3^0(\mathbb{R})$.

A basis of \mathcal{S} can be found by left multiplying \mathbf{P} by all the basis vectors of $\mathbf{C}_3^0(\mathbb{R})$. The reader can easily show that we obtain the following four matrices:

$$\begin{aligned} \mathbf{P} &= \frac{1}{2}(\mathbf{1} + \mathbf{e}_3) = \begin{pmatrix} 1 & 0 \\ 0 & 0 \end{pmatrix}, & \mathbf{e}_1\mathbf{P} &= \frac{1}{2}(\mathbf{e}_1 + \mathbf{e}_1\mathbf{e}_3) = \begin{pmatrix} 0 & 0 \\ 1 & 0 \end{pmatrix}, \\ \mathbf{e}_2\mathbf{P} &= \frac{1}{2}(\mathbf{e}_2 + \mathbf{e}_2\mathbf{e}_3) = \begin{pmatrix} i & 0 \\ 0 & 0 \end{pmatrix}, & i\mathbf{e}_1\mathbf{P} &= \frac{1}{2}(i\mathbf{e}_1 + i\mathbf{e}_1\mathbf{e}_3) = \begin{pmatrix} 0 & 0 \\ i & 0 \end{pmatrix}. \end{aligned} \tag{31.12}$$

By Theorem 27.3.2, all Clifford algebras are either simple or the direct sum of two identical simple algebras. By Theorem 3.5.27 and Proposition 3.5.22, a division algebra of a Clifford algebra can be obtained by right and left multiplying the algebra by a primitive idempotent. Since \mathbf{P} is such an

³It is not exactly an isomorphism, but a homomorphism which is locally an isomorphism, but not globally. Because of the double-valuedness of the kernel of the homomorphism of Theorem 31.2.6, one can think of $\mathbf{Spin}(3, 0)$ as two identical copies of $SO(3)$.

⁴Here we are ignoring the fact that the entries of the 2-column are functions rather than numbers. The full treatment of spinors whose entries are functions requires the tensor analysis of Clifford algebras, the so-called *spin bundles*, a topic which is beyond the scope of this book.

idempotent, we can extract the division algebra of $\mathbf{C}_3^0(\mathbb{R})$ by right and left multiplying it by \mathbf{P} :

$$\mathcal{D}_3^0 \cong \mathbf{P}\mathbf{C}_3^0(\mathbb{R})\mathbf{P}.$$

Since we have already right multiplied $\mathbf{C}_3^0(\mathbb{R})$ by \mathbf{P} , to get \mathcal{D}_3^0 we need to multiply the vectors in Eq. (31.12) by \mathbf{P} on the left. It then follows that

$$\mathcal{D}_3^0 = \{\alpha\mathbf{P} + \beta\mathbf{e}_2\mathbf{P}\} = \left\{ \begin{pmatrix} \alpha + i\beta & 0 \\ 0 & 0 \end{pmatrix} \middle| \alpha, \beta \in \mathbb{R} \right\} \cong \mathbb{C},$$

which is the obvious statement that the (only) division algebra of $\mathcal{M}_2(\mathbb{C})$ is \mathbb{C} .

A general division algebra is only one step away from being a field: it has to be commutative as well. In the majority of applications in physics, \mathbb{R} and \mathbb{C} are the only two division algebras of interest. And since they are both commutative, the ordering of scalar multiplication of an algebra \mathcal{A} is irrelevant:

$$\alpha\mathbf{a} = \mathbf{a}\alpha \quad \text{for } \mathbf{a} \in \mathcal{A}, \alpha \in \mathbb{F}$$

where \mathbb{F} is either \mathbb{R} or \mathbb{C} . To be as general as possible, we relax this condition of commutativity and distinguish between right and left multiplication by the elements of the division algebra.

Now note that with $\mathcal{S} \cong \mathbf{C}_3^0(\mathbb{R})\mathbf{P}$ and $\mathbb{D} \equiv \mathcal{D}_3^0 \cong \mathbf{P}\mathbf{C}_3^0(\mathbb{R})\mathbf{P}$, the natural order of multiplication of \mathcal{S} by an element of \mathbb{D} is right multiplication because

$$\mathcal{S}\mathbb{D} \cong (\mathbf{C}_3^0(\mathbb{R})\mathbf{P})(\mathbf{P}\mathbf{C}_3^0(\mathbb{R})\mathbf{P}) = (\mathbf{C}_3^0(\mathbb{R})\mathbf{P})(\mathbf{C}_3^0(\mathbb{R})\mathbf{P}) = \mathcal{S}\mathcal{S} \subset \mathcal{S}.$$

The left multiplication of a left ideal of an algebra by its division algebras, in general, does not give back the left ideal. In our case here it does because the division algebra is just \mathbb{C} , which is commutative.

With a multiplication by a division algebra, \mathcal{S} becomes a linear structure—a vector space on \mathbb{D} . We can thus construct the representation $\rho^{(\mathcal{S})}$, the regular representation of $\mathbf{C}_3^0(\mathbb{R})$ in \mathcal{S} as given in Definition 4.5.8 and Theorem 4.5.9. We want to find a matrix representation of $\mathbf{C}_3^0(\mathbb{R})$ in \mathcal{S} . To do so, we need to pick a basis of \mathcal{S} and represent elements of $\mathbf{C}_3^0(\mathbb{R})$ in that basis. As a *complex* vector space (recall that $\mathbb{D} = \mathbb{C}$) \mathcal{S} is two-dimensional. Take $\{\mathbf{P}_1, \mathbf{P}_2\} \equiv \{\mathbf{P}, \mathbf{e}_1\mathbf{P}\}$ as the basis of \mathcal{S} . To find the representation of an arbitrary element of $\mathbf{C}_3^0(\mathbb{R})$, it is sufficient to find matrices representing the generators of $\mathbf{C}_3^0(\mathbb{R})$. Using the basis in Eq. (31.10) and identifying \mathbf{e}_{123} as i (because $\mathbf{e}_{123}^2 = -\mathbf{1}$), we obtain

$$\begin{aligned} \mathbf{e}_1\mathbf{P}_1 &= \mathbf{e}_1\mathbf{P} = \mathbf{P}_2 = 0 \cdot \mathbf{P}_1 + 1 \cdot \mathbf{P}_2, \\ \mathbf{e}_1\mathbf{P}_2 &= \mathbf{e}_1\mathbf{e}_1\mathbf{P} = \mathbf{P}_1 = 1 \cdot \mathbf{P}_1 + 0 \cdot \mathbf{P}_2, \end{aligned}$$

from which we deduce that the first basis vector is represented by the matrix $\begin{pmatrix} 0 & 1 \\ 1 & 0 \end{pmatrix}$. Similarly,

$$\begin{aligned} \mathbf{e}_2\mathbf{P}_1 &= \mathbf{e}_2\mathbf{P} = i\mathbf{P}_2 = 0 \cdot \mathbf{P}_1 + i \cdot \mathbf{P}_2, \\ \mathbf{e}_2\mathbf{P}_2 &= \mathbf{e}_2\mathbf{e}_1\mathbf{P} = -i\mathbf{P}_1 = -i \cdot \mathbf{P}_1 + 0 \cdot \mathbf{P}_2, \end{aligned}$$

and

$$\begin{aligned}\mathbf{e}_3 \mathbf{P}_1 &= \mathbf{e}_3 \mathbf{P} = \mathbf{P} = 1 \cdot \mathbf{P}_1 + 0 \cdot \mathbf{P}_2, \\ \mathbf{e}_3 \mathbf{P}_2 &= \mathbf{e}_3 \mathbf{e}_1 \mathbf{P} = -\mathbf{P}_2 = 0 \cdot \mathbf{P}_1 - 1 \cdot \mathbf{P}_2\end{aligned}$$

give rise to matrices $\begin{pmatrix} 0 & -i \\ i & 0 \end{pmatrix}$ and $\begin{pmatrix} 1 & 0 \\ 0 & -1 \end{pmatrix}$, respectively. We thus recover the Pauli spin matrices.

31.2.2 Spinors for $\mathbf{C}_\mu^v(\mathbb{R})$

All the foregoing observation regarding $\mathbf{C}_3^0(\mathbb{R})$ has its generalization to the Clifford algebras $\mathbf{C}_\mu^v(\mathbb{R})$. Central to the discussion was the existence of a primitive idempotent, because it gave rise to a minimal left ideal and the division algebra (basically the scalars), from which one could find the matrices representing the basis vectors of the algebra, and from those the matrix representation of the entire algebra.

The case of $\mathbf{C}_3^0(\mathbb{R})$, although illustrative, is not general enough. As will become apparent, this algebra, to within equivalence of some sort, has only one primitive idempotent, which we could guess from our knowledge of 2×2 matrices. In general, the task of finding the primitive idempotent—by “inspection”—is not easy. Fortunately, there is a procedure which routinely determines a primitive idempotent for any Clifford algebras $\mathbf{C}_\mu^v(\mathbb{R})$.

The idea is to start with one of the multi-vectors in the **standard basis**

$$\{\mathbf{1}, \mathbf{e}_{i_1 \dots i_r} \mid i_1 < \dots < i_r\}_{r=1}^{\mu+v} \quad (31.13)$$

of $\mathbf{C}_\mu^v(\mathbb{R})$, label it \mathbf{e}_K and note that

$$\mathbf{P}_K^+ = \frac{1}{2}(\mathbf{1} + \mathbf{e}_K), \quad \text{and} \quad \mathbf{P}_K^- = \frac{1}{2}(\mathbf{1} - \mathbf{e}_K)$$

are two mutually orthogonal idempotents of $\mathbf{C}_\mu^v(\mathbb{R})$ which sum up to $\mathbf{1}$. Therefore, the algebra can be reduced to the (vector) direct sum of two sub-algebras:

$$\mathbf{C}_\mu^v(\mathbb{R}) = \mathbf{C}_\mu^v(\mathbb{R})\mathbf{P}_K^+ \oplus_V \mathbf{C}_\mu^v(\mathbb{R})\mathbf{P}_K^- \equiv \mathbf{C}_{\mu,v}^+(\mathbb{R}) \oplus_V \mathbf{C}_{\mu,v}^-(\mathbb{R}).$$

Note that both the idempotency and mutual orthogonality of \mathbf{P}_K^\pm are important in making sure that the above is indeed a vector *direct* sum. Here is why: if $\mathbf{x} \in \mathbf{C}_{\mu,v}^+(\mathbb{R}) \cap \mathbf{C}_{\mu,v}^-(\mathbb{R})$. Then it can be written as $\mathbf{x} = \mathbf{a}\mathbf{P}_K^+ = \mathbf{b}\mathbf{P}_K^-$. Thus, multiplying both sides of the last equality on the right by \mathbf{P}_K^- and using *both* properties of \mathbf{P}_K^\pm , we get

$$\mathbf{a}\mathbf{P}_K^+\mathbf{P}_K^- = \mathbf{b}(\mathbf{P}_K^-)^2 \Rightarrow \mathbf{0} = \mathbf{b}\mathbf{P}_K^- = \mathbf{x}.$$

Next we want to break up the $C_{\mu,\nu}^{\pm}(\mathbb{R})$. To do so, we choose a new multi-vector \mathbf{e}_M and construct \mathbf{P}_M^{\pm} as before. Multiplying these on the left by $C_{\mu,\nu}^{\pm}(\mathbb{R})$, we obtain

$$C_{\mu}^{\nu}(\mathbb{R}) = C_{\mu}^{\nu}(\mathbb{R})\mathbf{P}_K^+\mathbf{P}_M^+ \oplus_V C_{\mu}^{\nu}(\mathbb{R})\mathbf{P}_K^-\mathbf{P}_M^+ \oplus_V C_{\mu}^{\nu}(\mathbb{R})\mathbf{P}_K^+\mathbf{P}_M^- \oplus_V C_{\mu}^{\nu}(\mathbb{R})\mathbf{P}_K^-\mathbf{P}_M^-.$$

As before, we need to make sure that all the double idempotents are indeed idempotents and mutually orthogonal. From

$$(\mathbf{P}_K^+\mathbf{P}_M^+)^2 = \mathbf{P}_K^+\mathbf{P}_M^+\mathbf{P}_K^+\mathbf{P}_M^+ = \mathbf{P}_K^+\mathbf{P}_M^+$$

and

$$(\mathbf{P}_K^-\mathbf{P}_M^+)^2 = \mathbf{P}_K^-\mathbf{P}_M^+\mathbf{P}_K^-\mathbf{P}_M^+ = \mathbf{P}_K^-\mathbf{P}_M^+$$

we conclude that \mathbf{P}_M^+ should commute with both \mathbf{P}_K^+ and \mathbf{P}_K^- . This commutation is achieved by demanding that $\mathbf{e}_K\mathbf{e}_M = \mathbf{e}_M\mathbf{e}_K$, which also guarantees the commutativity of the remaining idempotents as well as the orthogonality of all four double idempotents.

Each time we multiply the components—which are, by the way, left ideals of $C_{\mu}^{\nu}(\mathbb{R})$ —of the direct vector sum by a new idempotent, we decrease the dimension by a factor of 2. It is therefore clear that eventually we will obtain a minimal ideal. The question is when should we stop? To answer this question, we first need

Radon-Hurwitz number **Definition 31.2.8** The Radon-Hurwitz number r_i for $i \in \mathbb{Z}$ is given by

$$\begin{aligned} r_i &= i && \text{for } i = 0, 1, 2; && r_3 = 2; \\ r_i &= 3 && \text{for } i = 4, 5, 6, 7; \\ r_{i+8} &= r_i + 4. \end{aligned}$$

Now for the theorem which gives a primitive idempotent for $C_{\mu}^{\nu}(\mathbb{R})$, and which we state without proof:

Theorem 31.2.9 In the standard basis (31.13) of $C_{\mu}^{\nu}(\mathbb{R})$ there are $k_{\mu}^{\nu} = \nu - r_{\nu-\mu}$ elements \mathbf{e}_{M_i} , which commute with one another and square to $\mathbf{1}$. They generate $2^{k_{\mu}^{\nu}}$ idempotents which add up to $\mathbf{1}$, and the product,

$$\mathbf{f} = \prod_{i=1}^{k_{\mu}^{\nu}} \frac{1}{2}(\mathbf{1} + \mathbf{e}_{M_i}),$$

is primitive in $C_{\mu}^{\nu}(\mathbb{R})$.

We now see why the construction of the spinors and Pauli spin matrices was so straightforward:

$$k_3^0 = 0 - r_{-3} = -(r_5 - 4) = 1;$$

and why the four idempotents of Eq. (27.57) worked in the construction of the Majorana representation of the Dirac matrices:

$$k_3^1 = 1 - r_{1-3} = 1 - r_{-2} = 1 - (r_6 - 4) = 1 - (-1) = 2,$$

and the number of idempotents is $2^2 = 4$.

Definition 31.2.10 The minimal left ideal $S_\mu^v \equiv C_\mu^v(\mathbb{R})\mathbf{f}$, where \mathbf{f} is as in Theorem 31.2.9, together with the right multiplication by the division algebra $\mathbb{D} \equiv \mathbf{f}C_\mu^v(\mathbb{R})\mathbf{f}$ (multiplication by a scalar), becomes a \mathbb{D} -linear structure called the **spinor space** of $C_\mu^v(\mathbb{R})$. spinor space

As indicated before, for all $C_\mu^v(\mathbb{R})$, the division algebra \mathbb{D} is \mathbb{R} , \mathbb{C} , or \mathbb{H} . Since almost all cases of physical interest deal with \mathbb{R} or \mathbb{C} , scalar multiplication can be on the left or right. With S_μ^v a minimal left ideal of $C_\mu^v(\mathbb{R})$, by Theorem 4.5.9 we have the following:

Definition 31.2.11 The irreducible representation $\rho : C_\mu^v(\mathbb{R}) \rightarrow \text{End}_{\mathbb{D}}(S_\mu^v)$ given by spin representation

$$\rho(\mathbf{a})|s\rangle = \mathbf{a}s, \quad \mathbf{a} \in C_\mu^v(\mathbb{R}), \quad |s\rangle = \mathbf{s} \in S_\mu^v$$

is called the **spin representation** of $C_\mu^v(\mathbb{R})$. If $\mu - v \neq 1 \pmod 4$, $C_\mu^v(\mathbb{R})$ is simple and therefore the spin representation is faithful.

The procedure for finding the spin representations becomes fairly straightforward. First find the commuting multi-vectors. The easiest way is to pick one of the basis vectors of \mathbb{R}_n^v , say \mathbf{e}_i with i one of the μ indices. Once this is picked, the rest of the choices have to be even multi-vectors not including i in their indices so that \mathbf{e}_i commutes with them. So, next pick a bivector, say \mathbf{e}_{jk} with j being one of the v indices (why?) and k one of the μ ones not equal to i . The next pick has to be even and not include i, j , or k . Continuing in this fashion, all the k_μ^v idempotents can be built.

After finding the idempotents, multiply them to get \mathbf{f} . Then multiply \mathbf{f} on the left by all the basis vectors, and choose a set of linearly independent vectors from among the results to form a basis for S_μ^v . Left-multiply the basis vectors of S_μ^v by \mathbf{f} to find the division algebra \mathbb{D} of the representation. This usually results either in a one-dimensional algebra, which can be identified as \mathbb{R} , or in a two-dimensional algebra one of whose basis vectors squares to $-\mathbf{1}$, in which case the algebra can be identified as \mathbb{C} .

Now multiply the basis of S_μ^v on the left by all the basis vectors of $C_\mu^v(\mathbb{R})$. The result will be a \mathbb{D} -linear combination of the basis vectors of S_μ^v the coefficients of which form the columns of the matrix representation of the basis vectors of $C_\mu^v(\mathbb{R})$. The important case of $C_3^1(\mathbb{R})$ illustrates all of these points.

31.2.3 $C_3^1(\mathbb{R})$ Revisited

As noted earlier, $k_3^1 = 2$. So, we pick \mathbf{e}_1 and $\mathbf{e}_{02} \equiv \mathbf{e}_0\mathbf{e}_2 \equiv \mathbf{e}_0 \vee \mathbf{e}_2$ as the two commuting vectors out of which we can construct our idempotents.⁵ It follows that

$$\mathbf{f} = \frac{1}{4}(\mathbf{1} + \mathbf{e}_1)(\mathbf{1} + \mathbf{e}_{02}).$$

Next, we apply all the basis vectors of $C_3^1(\mathbb{R})$ to \mathbf{f} to generate a basis for S_3^1 . We quote the results and ask the reader to verify them:

$$\begin{array}{llll} \mathbf{1} \cdot \mathbf{f} = \mathbf{f}, & \mathbf{e}_0 \cdot \mathbf{f} \equiv \mathbf{f}_0, & \mathbf{e}_1 \cdot \mathbf{f} = \mathbf{f}, & \mathbf{e}_2 \cdot \mathbf{f} \equiv -\mathbf{f}_0, \\ \mathbf{e}_3 \cdot \mathbf{f} \equiv \mathbf{f}_3, & \mathbf{e}_{01} \cdot \mathbf{f} \equiv \mathbf{f}_0, & \mathbf{e}_{02} \cdot \mathbf{f} = \mathbf{f}, & \mathbf{e}_{03} \cdot \mathbf{f} \equiv \mathbf{f}_4, \\ \mathbf{e}_{12} \cdot \mathbf{f} = \mathbf{f}_0, & \mathbf{e}_{13} \cdot \mathbf{f} = -\mathbf{f}_3, & \mathbf{e}_{23} \cdot \mathbf{f} = -\mathbf{f}_4, & \mathbf{e}_{012} \cdot \mathbf{f} = -\mathbf{f}, \\ \mathbf{e}_{013} \cdot \mathbf{f} = -\mathbf{f}_4, & \mathbf{e}_{023} \cdot \mathbf{f} = \mathbf{f}_3, & \mathbf{e}_{123} \cdot \mathbf{f} = -\mathbf{f}_4, & \mathbf{e}_{0123} \cdot \mathbf{f} = \mathbf{f}_3. \end{array}$$

There are four different elements, \mathbf{f} , \mathbf{f}_0 , \mathbf{f}_3 , and \mathbf{f}_4 . Different, of course doesn't mean linearly independent, but by writing each out in terms of the basis vectors of $C_3^1(\mathbb{R})$, the reader can verify that the four elements are indeed linearly independent.

Now we find \mathbb{D} by multiplying S_3^1 on the left by \mathbf{f} . This means multiplying the vectors in its basis on the left and collecting all the linearly independent vectors we obtain. We illustrate one such calculation and let the reader show that we get zeros except when we multiply \mathbf{f} by itself. As an illustration we show that $\mathbf{f} \cdot \mathbf{f}_4 = \mathbf{0}$:

$$\begin{aligned} \mathbf{f} \cdot \mathbf{f}_4 &= \mathbf{f}\mathbf{e}_0\mathbf{e}_3\mathbf{f} = \frac{1}{16}(\mathbf{1} + \mathbf{e}_1)(\mathbf{1} + \mathbf{e}_{02})\mathbf{e}_0\mathbf{e}_3(\mathbf{1} + \mathbf{e}_1)(\mathbf{1} + \mathbf{e}_{02}) \\ &= \frac{1}{16}\mathbf{e}_0(\mathbf{1} - \mathbf{e}_1)(\mathbf{1} - \mathbf{e}_{02})(\mathbf{1} - \mathbf{e}_1)(\mathbf{1} + \mathbf{e}_{02})\mathbf{e}_3 \\ &= \frac{1}{16}\mathbf{e}_0(\mathbf{1} - \mathbf{e}_1)^2 \underbrace{(\mathbf{1} - \mathbf{e}_{02})(\mathbf{1} + \mathbf{e}_{02})}_{=\mathbf{0}} \mathbf{e}_3 = \mathbf{0}. \end{aligned}$$

Thus, \mathbb{D} is one-dimensional, i.e., it is isomorphic to \mathbb{R} . Therefore, S_3^1 provides a real representation of $C_3^1(\mathbb{R})$.

Our next task is to find the matrices representing the generators of $C_3^1(\mathbb{R})$, namely \mathbf{e}_0 , \mathbf{e}_1 , \mathbf{e}_2 , and \mathbf{e}_3 . We show how to construct the zeroth matrix, leaving the rest of the matrices to the reader. To find the matrix corresponding to \mathbf{e}_0 , multiply the i th basis vector of S_3^1 by \mathbf{e}_0 , write it as a linear combination of the basis vectors, and note that the coefficients form the i th column of the desired matrix. Labeling \mathbf{f} , \mathbf{f}_0 , \mathbf{f}_3 , and \mathbf{f}_4 as 1, 2, 3, and 4, we obtain

$$\mathbf{e}_0\mathbf{f} = \mathbf{f}_0 = 0 \cdot \mathbf{f} + 1 \cdot \mathbf{f}_0 + 0 \cdot \mathbf{f}_3 + 0 \cdot \mathbf{f}_4,$$

⁵Here, we are again using the physicists' convention of setting $\mathbf{e}_4 = \mathbf{e}_0$, with $\mathbf{e}_0^2 = -\mathbf{1}$.

yielding $(0, 1, 0, 0,)$ as the entries of the first column. Multiplying the other basis vectors, we get

$$\mathbf{e}_0 \mathbf{f}_0 = \mathbf{e}_0^2 \mathbf{f} = -\mathbf{f} = -1 \cdot \mathbf{f} + 0 \cdot \mathbf{f}_0 + 0 \cdot \mathbf{f}_3 + 0 \cdot \mathbf{f}_4,$$

$$\mathbf{e}_0 \mathbf{f}_3 = \mathbf{e}_0 \mathbf{e}_3 \mathbf{f} = \mathbf{f}_4 = 0 \cdot \mathbf{f} + 0 \cdot \mathbf{f}_0 + 0 \cdot \mathbf{f}_3 + 1 \cdot \mathbf{f}_4,$$

$$\mathbf{e}_0 \mathbf{f}_4 = \mathbf{e}_0 \mathbf{e}_0 \mathbf{e}_3 \mathbf{f} = -\mathbf{e}_3 \mathbf{f} = -\mathbf{f}_3 = 0 \cdot \mathbf{f} + 0 \cdot \mathbf{f}_0 - 1 \cdot \mathbf{f}_3 + 0 \cdot \mathbf{f}_4.$$

Collecting the columns and denoting the matrix by E_0 , we get

$$E_0 = \begin{pmatrix} 0 & -1 & 0 & 0 \\ 1 & 0 & 0 & 0 \\ 0 & 0 & 0 & -1 \\ 0 & 0 & 1 & 0 \end{pmatrix}.$$

The matrices representing the other basis vectors can be found similarly. We collect all the four matrices in the following equation:

$$\begin{aligned} E_0 &= \begin{pmatrix} 0 & -1 & 0 & 0 \\ 1 & 0 & 0 & 0 \\ 0 & 0 & 0 & -1 \\ 0 & 0 & 1 & 0 \end{pmatrix}, & E_1 &= \begin{pmatrix} 1 & 0 & 0 & 0 \\ 0 & -1 & 0 & 0 \\ 0 & 0 & -1 & 0 \\ 0 & 0 & 0 & 1 \end{pmatrix}, \\ E_2 &= \begin{pmatrix} 0 & -1 & 0 & 0 \\ -1 & 0 & 0 & 0 \\ 0 & 0 & 0 & -1 \\ 0 & 0 & -1 & 0 \end{pmatrix}, & E_3 &= \begin{pmatrix} 0 & 0 & 1 & 0 \\ 0 & 0 & 0 & -1 \\ 1 & 0 & 0 & 0 \\ 0 & -1 & 0 & 0 \end{pmatrix}. \end{aligned} \quad (31.14)$$

The reader may check that these matrices satisfy the Clifford algebra rule,

$$E_\mu E_\nu + E_\nu E_\mu = 2\eta_{\mu\nu} 1,$$

as they should.

These matrices are one representation of $\mathbf{C}_3^1(\mathbb{R})$. Section 27.4.3 gave us another. Are these two representations equivalent? If they are, then by Definition 4.5.6, there should be an invertible linear transformation connecting the two. So, we try to find an invertible matrix A such that $A\gamma_\mu A^{-1} = E_\mu$, or $A\gamma_\mu = E_\mu A$. Assume a general A and choose its elements so that these matrix equalities hold. For example, when $\mu = 0$, we have, on the one had

$$\begin{aligned} A\gamma_0 &= \begin{pmatrix} \alpha_{00} & \alpha_{01} & \alpha_{02} & \alpha_{03} \\ \alpha_{10} & \alpha_{11} & \alpha_{12} & \alpha_{13} \\ \alpha_{20} & \alpha_{21} & \alpha_{22} & \alpha_{23} \\ \alpha_{30} & \alpha_{31} & \alpha_{32} & \alpha_{33} \end{pmatrix} \begin{pmatrix} 0 & 0 & 0 & -1 \\ 0 & 0 & 1 & 0 \\ 0 & -1 & 0 & 0 \\ 1 & 0 & 0 & 0 \end{pmatrix} \\ &= \begin{pmatrix} \alpha_{03} & -\alpha_{02} & \alpha_{01} & -\alpha_{00} \\ \alpha_{13} & -\alpha_{12} & \alpha_{11} & -\alpha_{10} \\ \alpha_{23} & -\alpha_{22} & \alpha_{21} & -\alpha_{20} \\ \alpha_{33} & -\alpha_{32} & \alpha_{31} & -\alpha_{30} \end{pmatrix} \end{aligned}$$

and on the other hand

$$\begin{aligned} E_0 A &= \begin{pmatrix} 0 & -1 & 0 & 0 \\ 1 & 0 & 0 & 0 \\ 0 & 0 & 0 & -1 \\ 0 & 0 & 1 & 0 \end{pmatrix} \begin{pmatrix} \alpha_{00} & \alpha_{01} & \alpha_{02} & \alpha_{03} \\ \alpha_{10} & \alpha_{11} & \alpha_{12} & \alpha_{13} \\ \alpha_{20} & \alpha_{21} & \alpha_{22} & \alpha_{23} \\ \alpha_{30} & \alpha_{31} & \alpha_{32} & \alpha_{33} \end{pmatrix} \\ &= \begin{pmatrix} -\alpha_{10} & -\alpha_{11} & -\alpha_{12} & -\alpha_{13} \\ \alpha_{00} & \alpha_{01} & \alpha_{02} & \alpha_{03} \\ -\alpha_{30} & -\alpha_{31} & -\alpha_{32} & -\alpha_{33} \\ \alpha_{20} & \alpha_{21} & \alpha_{22} & \alpha_{23} \end{pmatrix}. \end{aligned}$$

For these two matrices to be equal, we must have

$$\begin{aligned} \alpha_{10} &= -\alpha_{03}, & \alpha_{11} &= \alpha_{02}, & \alpha_{12} &= -\alpha_{01}, & \alpha_{13} &= \alpha_{00}, \\ \alpha_{30} &= -\alpha_{23}, & \alpha_{31} &= \alpha_{22}, & \alpha_{32} &= -\alpha_{21}, & \alpha_{33} &= \alpha_{20}. \end{aligned} \quad (31.15)$$

These conditions eliminate some of the elements of A , so that it now becomes

$$A = \begin{pmatrix} \alpha_{00} & \alpha_{01} & \alpha_{02} & \alpha_{03} \\ -\alpha_{03} & \alpha_{02} & -\alpha_{01} & \alpha_{00} \\ \alpha_{20} & \alpha_{21} & \alpha_{22} & \alpha_{23} \\ -\alpha_{23} & \alpha_{22} & -\alpha_{21} & \alpha_{20} \end{pmatrix}.$$

The straightforward calculation of determining the rest of the elements of A is left to the reader. We simply quote the result:

$$A = \alpha_{00} \begin{pmatrix} 1 & 0 & 0 & 0 \\ 0 & 0 & 0 & 1 \\ 0 & 0 & 1 & 0 \\ 0 & 1 & 0 & 0 \end{pmatrix} = \frac{1}{\alpha_{00}} A^{-1}.$$

31.3 Problems

31.1 (a) Use Eq. (31.1) to prove (31.2).

(b) Use the invertible vector \mathbf{y} with $\mathbf{g}(\mathbf{y}, \mathbf{y}) \neq 0$ in Eq. (27.14) to show that

$$\mathbf{y} = \mathbf{g}(\mathbf{y}, \mathbf{y}) \mathbf{y}^{-1}.$$

(c) Multiply both sides of Eq. (27.14) written for \mathbf{x} and \mathbf{y} by \mathbf{y}^{-1} and use (b) to show that $\text{ad}(\mathbf{y})\mathbf{x} = \mathbf{R}_y \mathbf{x}$.

31.2 Prove Corollary 31.1.8. Hint: Show that $\overline{\omega_V(\mathbf{a})} = \omega_V(\bar{\mathbf{a}})$.

31.3 Prove the first and third relations of Corollary 31.1.10.

31.4 Provide the details of the proof of Corollary 31.1.15.

31.5 Consider the Clifford algebra $\mathbf{C}(2, 0)$. Let $\mathbf{a} = \alpha_0 \mathbf{1} + \alpha_1 \mathbf{e}_1 + \alpha_2 \mathbf{e}_2 + \alpha_3 \mathbf{e}_{12}$ be an element of this algebra.

- (a) With $\mathbf{b} = \beta_0 \mathbf{1} + \beta_1 \mathbf{e}_1 + \beta_2 \mathbf{e}_2 + \beta_3 \mathbf{e}_{12}$, set $\mathbf{a} \vee \mathbf{b} = \mathbf{1}$, find β_i in terms of α_i s to show that

$$\mathbf{a}^{-1} = \frac{\alpha_0 \mathbf{1} - \alpha_1 \mathbf{e}_1 - \alpha_2 \mathbf{e}_2 - \alpha_3 \mathbf{e}_{12}}{\alpha_0^2 - \alpha_1^2 - \alpha_2^2 + \alpha_3^2}.$$

- (b) Show that for Eq. (31.1) to hold, we must have

$$\alpha_0 \alpha_1 + \alpha_2 \alpha_3 = 0 \quad \text{and} \quad \alpha_0 \alpha_2 - \alpha_1 \alpha_3 = 0.$$

Therefore, $\Gamma(2, 0) = \{\alpha_1 \mathbf{e}_1 + \alpha_2 \mathbf{e}_2, \alpha_0 \mathbf{1} + \alpha_3 \mathbf{e}_{12}\}$.

- (c) Now show that

$$\mathbf{Spin}(2, 0) \cong \{z \in \mathbb{C} \mid |z| = 1\} \cong U(1) \cong \{e^{i\theta} \mid \theta \in \mathbb{R}\}.$$

31.6 Using the procedure of Problem 31.5 show that

$$\mathbf{Spin}(3, 0) \cong \{q \in \mathbb{H} \mid |q| = 1\} \cong SU(2).$$

Warning: You may have to use a computer algebra software!

31.7 Show that $\{1, \sigma_1, \sigma_2, \sigma_3, i1, i\sigma_1, i\sigma_2, i\sigma_3\}$, with σ_i given by Eq. (31.9), are eight linearly independent vectors of a *real* vector space.

31.8 Find k_μ^1 for $\mu = 1, \dots, 8$. For $\mu = 6, 7, 8$ find the corresponding maximum number of idempotents.

31.9 Show that the maximal number of idempotents k_μ^v satisfies the periodicity condition

$$k_{\mu+8}^v = k_\mu^v + 4.$$

31.10 Go through the same calculation as done in the book for \mathbf{E}_0 to find the other matrices of Eq. (31.14).

31.11 Choose two different multi-vectors for $\mathbf{C}_3^1(\mathbb{R})$; find the corresponding \mathbf{f} , \mathbb{S}_3^1 , \mathbb{D} , and the matrices representing the basis vectors \mathbf{e}_0 , \mathbf{e}_1 , \mathbf{e}_2 , and \mathbf{e}_3 .

Lie groups and Lie algebras, because of their manifold—and therefore, differentiability—structure, find very natural applications in areas of physics and mathematics in which symmetry and differentiability play important roles. Lie himself started the subject by analyzing the symmetry of differential equations in the hope that a systematic method of solving them could be discovered. Later, Emmy Noether applied the same idea to variational problems involving symmetries and obtained one of the most beautiful pieces of mathematical physics: the relation between symmetries and conservation laws. More recently, generalizing the gauge invariance of electromagnetism, Yang and Mills have considered nonabelian gauge theories in which gauge invariance is governed by a nonabelian Lie group. Such theories have been successfully built for three of the four fundamental interactions: electromagnetism, weak nuclear, and strong nuclear. Furthermore, it has been possible to cast the fourth interaction, gravity—as described by Einstein’s general theory of relativity—in a language very similar to the other three interactions with the promise of unifying all four interactions into a single force. This chapter is devoted to a treatment of the first topic, application of Lie groups to DEs. The second topic, the calculus of variations and conservation laws, will be discussed in the next chapter. The third topic, that of gauge theories, is treated under the more general setting of fiber bundles in the last part of the book.

32.1 Symmetries of Algebraic Equations

The symmetry group of a system of DEs is a transformation group that acts on both the independent and dependent variables and transforms solutions of the system to other solutions. In order to understand this symmetry group, we shall first tackle the simpler question of the symmetries of a system of *algebraic* equations.

Definition 32.1.1 Let G be a local Lie group of transformations acting on a manifold M . A subset $\mathcal{S} \subset M$ is called **G -invariant** and G is called a **symmetry group** of \mathcal{S} if whenever $g \cdot P$ is defined for $P \in \mathcal{S}$ and $g \in G$, then $g \cdot P \in \mathcal{S}$.

G-invariance and
symmetry group defined

Example 32.1.2 Let $M = \mathbb{R}^2$.

- (a) Let $G = \mathbb{R}^+$ be the abelian multiplicative group of real numbers. Let it act on M componentwise: $r \cdot (x, y) = (rx, ry)$. Then any line going through the origin is a G -invariant subset of \mathbb{R}^2 .
- (b) If $G = SO(2)$ and it acts on M as usual, then any circle is a G -invariant subset of \mathbb{R}^2 .

system of algebraic equations and their symmetry group

A *system of algebraic equations* is a system of equations

$$F_\nu(x) = 0, \quad \nu = 1, 2, \dots, n,$$

in which $F_\nu : M \rightarrow \mathbb{R}$ is smooth. A *solution* is a point $x \in M$ such that $F_\nu(x) = 0$ for $\nu = 1, \dots, n$. The *solution set* of the system is the collection of all solutions. A Lie group G is called a **symmetry group of the system** if the solution set is G -invariant.

invariant map

Definition 32.1.3 Let G be a local Lie group of transformations acting on a manifold M . A map $F : M \rightarrow N$, where N is another manifold, is called a **G -invariant map** if for all $P \in M$ and all $g \in G$ such that $g \cdot P$ is defined, $F(g \cdot P) = F(P)$. A real-valued G -invariant function is called simply an **invariant**.

The crucial property of Lie group theory is that locally the group and its algebra “look alike”. This allows the complicated nonlinear conditions of invariance of subsets and functions to be replaced by the simpler linear conditions of invariance under infinitesimal actions. From Definition 29.1.30, we obtain the following proposition.

Proposition 32.1.4 Let G be a local group of transformations acting on a manifold M . A smooth real-valued function $f : M \rightarrow \mathbb{R}$ is G -invariant if and only if

$$\xi_M|_P(f) = 0 \quad \text{for all } P \in M \tag{32.1}$$

and for every infinitesimal generator $\xi \in \mathfrak{g}$.

Example 32.1.5 The infinitesimal generator for $SO(2)$ is $\xi_M = x\partial_y - y\partial_x$. Any function of the form $f(x^2 + y^2)$ is an $SO(2)$ -invariant. To see this, we apply Proposition 32.1.4:

$$(x\partial_y - y\partial_x)f(x^2 + y^2) = x(2y)f' - y(2x)f' = 0,$$

where f' is the derivative of f .

The criterion for the invariance of the solution set of a system of equations is a little more complicated, because now we are not dealing with functions themselves, but with their solutions. The following theorem gives such a criterion (for a proof, see [Olve 86, pp. 82–83]):

Theorem 32.1.6 *Let G be a local Lie group of transformations acting on an m -dimensional manifold M . Let $F : M \rightarrow \mathbb{R}^n$, $n \leq m$, define a system of algebraic equations $\{F_\nu(x) = 0\}_{\nu=1}^n$, and assume that the Jacobian matrix $(\partial F_\nu / \partial x^k)$ is of rank n at every solution x of the system. Then G is a symmetry group of the system if and only if*

$$\xi_M|_x(F_\nu) = 0 \quad \forall \nu \text{ whenever } F_\nu(x) = 0 \quad (32.2)$$

for every infinitesimal generator $\xi \in \mathfrak{g}$.

Note that Eq. (32.2) is required to hold *only for solutions x of the system*.

Example 32.1.7 Let $M = \mathbb{R}^2$ and $G = SO(2)$. Consider $F : M \rightarrow \mathbb{R}$ defined by $F(x, y) = x^2 + y^2 - 1$. The Jacobian matrix is simply the gradient,

$$(\partial F / \partial x, \partial F / \partial y) = (2x, 2y),$$

and is of rank 1 for all points of the solution set, because it never vanishes at the points where $F(x, y) = 0$, i.e., the unit circle. It follows from Theorem 32.1.6 that G is a symmetry group of the equation $F(x, y) = 0$ if and only if $\xi_M|_{\mathbf{r}}(F) = 0$ whenever $\mathbf{r} \in S^1$. But

$$\xi_M|_{\mathbf{r}}(F) = (x\partial_y - y\partial_x)F|_{\mathbf{r}} = 2xy - 2yx = 0.$$

This is a proof of the obvious fact that $SO(2)$ takes points of S^1 to other points of S^1 .

As a less trivial example, consider the function $F : \mathbb{R}^2 \rightarrow \mathbb{R}$ given by

$$F(x, y) = x^2y^2 + y^4 + 2x^2 + y^2 - 2.$$

The infinitesimal action of the group yields

$$\xi_M(F) = (x\partial_y - y\partial_x)F = 2x^3y + 2xy^3 - 2xy = 2xy(x^2 + y^2 - 1).$$

The reader may check that $\xi_M(F) = 0$ whenever $F(x, y) = 0$. The Jacobian matrix of the “system” of equations is the gradient

$$\nabla F = (2xy^2 + 4x, 2x^2y + 4y^3 + 2y),$$

which vanishes only when $x = 0 = y$, which does not belong to the solution set. Therefore, the rank of the Jacobian matrix is 1. We conclude that the solution set of $F(x, y) = 0$ is a rotationally invariant subset of \mathbb{R}^2 . Indeed, we have

$$F(x, y) = x^2y^2 + y^4 + 2x^2 + y^2 - 2 = (y^2 + 2)(x^2 + y^2 - 1),$$

and the solution set is just the unit circle. Note that although the solution set of $F(x, y) = 0$ is G -invariant, the function itself is not.

We now discuss how to find invariants of a given group action. Start with a one-parameter group and write

$$\mathbf{v} \equiv \xi_M = X^i \frac{\partial}{\partial x^i}$$

for the infinitesimal generator of the group in some local coordinates. A local invariant $F(x)$ of the group is a solution of the linear, homogeneous PDE

$$\mathbf{v}(F) = X^1(x) \frac{\partial F}{\partial x^1} + \cdots + X^n(x) \frac{\partial F}{\partial x^n} = 0. \quad (32.3)$$

It follows that the gradient of F is perpendicular to the vector \mathbf{v} . Since the gradient of F is the normal to the hypersurface of constant F , we may consider the solution of Eq. (32.3) as a surface $F(x) = c$ whose normal is perpendicular to \mathbf{v} . Each normal determines one hypersurface, and since there are $n - 1$ linearly independent vectors perpendicular to \mathbf{v} , there must be $n - 1$ different hypersurfaces that solve (32.3). Let us write these hypersurfaces as

$$F^j(x^1, \dots, x^n) = c^j, \quad j = 1, 2, \dots, n - 1, \quad (32.4)$$

and note that

$$\Delta F^j \approx \sum_{i=1}^n \frac{\partial F^j}{\partial x^i} \Delta x^i = 0, \quad j = 1, 2, \dots, n - 1.$$

A solution to this equation is suggested by (32.3):

$$\Delta x^i = \alpha X^i \Rightarrow \frac{\Delta x^i}{X^i} = \alpha.$$

For $\Delta x^i \rightarrow dx^i$, we obtain the following set of ODEs, called the **characteristic system** of the original PDE,

characteristic system of a
PDE

$$\frac{dx^1}{X^1(x)} = \frac{dx^2}{X^2(x)} = \cdots = \frac{dx^n}{X^n(x)}, \quad (32.5)$$

whose solutions determine $\{F^j(x)\}_{j=1}^{n-1}$. To find these solutions,

Box 32.1.8 Take the equalities of (32.5) one at a time, solve the first order DE, write the solution in the form of (32.4), and read off the functions.

The reader may check that any function of the F^j 's is also a solution of the PDE. In fact, it can be shown that *any solution* of the PDE is a function of these F^j 's (see [Olve 86, pp. 86–90]).

Example 32.1.9 Once again, let us consider $SO(2)$, whose infinitesimal generator is $-y\partial_x + x\partial_y$. The characteristic “system” of equations is

$$\frac{dx}{-y} = \frac{dy}{x} \Rightarrow x dx + y dy = 0 \Rightarrow x^2 + y^2 = c.$$

Thus, $F(x, y) = x^2 + y^2$, or any function thereof, is an invariant of the rotation group in two dimensions.

As a less trivial example, consider the vector field

$$\mathbf{v} = -y \frac{\partial}{\partial x} + x \frac{\partial}{\partial y} + \sqrt{a^2 - z^2} \frac{\partial}{\partial z}$$

where a is a constant. The characteristic system of ODEs is

$$\frac{dx}{-y} = \frac{dy}{x} = \frac{dz}{\sqrt{a^2 - z^2}}.$$

The first equation was solved above, giving the invariant $F_1(x, y, z) = \sqrt{x^2 + y^2} = r$. To find the other invariant, solve for x and substitute in the second equation to obtain

$$\frac{dy}{\sqrt{r^2 - y^2}} = \frac{dz}{\sqrt{a^2 - z^2}}.$$

The solution to this DE is

$$\underbrace{\arcsin \frac{y}{r}}_{\alpha} = \arcsin \frac{z}{a} + C \Rightarrow \arcsin \frac{y}{r} - \arcsin \frac{z}{a} = C.$$

Hence, $F_2(x, y, z) = \arcsin(y/r) - \arcsin(z/a)$ is a second invariant. By taking the sine of F_2 , we can come up with an invariant that is algebraic (rather than trigonometric) in form:

$$\begin{aligned} s &= \sin F_2 = \sin(\alpha - \beta) = \sin \alpha \cos \beta - \cos \alpha \sin \beta \\ &= \frac{y}{r} \sqrt{1 - \frac{z^2}{a^2}} - \sqrt{1 - \frac{y^2}{r^2}} \frac{z}{a} = \frac{y\sqrt{a^2 - z^2} - xz}{ra}. \end{aligned}$$

Any function of r and s is also an invariant.

When the dimension of the Lie group is larger than one, the computation of the invariants can be very complicated. If $\{\mathbf{v}_k\}_{k=1}^r$ form a basis for the infinitesimal generators, then the invariants are the joint solutions of the system of first order PDEs

$$\mathbf{v}_k(F) = \sum_{j=1}^n X_k^j(x) \frac{\partial F}{\partial x^j}, \quad k = 1, \dots, r.$$

To find such a solution, one solves the first equation and finds all its invariants. Since any function of these invariants is also an invariant, it is natural to express F as a function of the invariants of \mathbf{v}_1 . One then writes the remaining equations in terms of these new variables and proceeds inductively.

Example 32.1.10 Consider the vector fields

$$\mathbf{u} = -y \partial_x + x \partial_y,$$

$$\mathbf{v} = \left(\frac{x^3z + xy^2z + a^3x}{\sqrt{x^2 + y^2}} \right) \partial_x + \left(\frac{x^2yz + y^3z + a^3y}{\sqrt{x^2 + y^2}} \right) \partial_y - (\sqrt{x^2 + y^2}z^2 + b^3) \partial_z$$

where a and b are constants. The invariants of \mathbf{u} are functions of $r = \sqrt{x^2 + y^2}$ and z . If we are to have a nontrivial solution, the invariant of \mathbf{v} as well as its PDE should be expressible in terms of $r = \sqrt{x^2 + y^2}$ and z . The reader may verify that

$$\mathbf{v}(F) = (r^2z + a^3) \frac{\partial F}{\partial r} - (rz^2 + b^3) \frac{\partial F}{\partial z} = 0$$

with the characteristic equation

$$\frac{dr}{r^2z + a^3} = -\frac{dz}{rz^2 + b^3}.$$

This is an exact first-order DE whose solutions are given by

$$\frac{1}{2}r^2z^2 + a^3z + b^3r = c$$

with c an arbitrary constant. Therefore, $F = \frac{1}{2}r^2z^2 + a^3z + b^3r$, or

$$F(x, y, z) = \frac{1}{2}(x^2 + y^2)z^2 + a^3z + b^3\sqrt{x^2 + y^2},$$

or a function thereof, is the single invariant of this group.

32.2 Symmetry Groups of Differential Equations

Let \mathcal{S} be a system of partial differential equations involving p independent variables $x = (x^1, \dots, x^p)$, and q dependent variables $u = (u^1, \dots, u^q)$. The solutions of the system are of the form $u = f(x)$, or, in component form, $u^\alpha = f^\alpha(x^1, \dots, x^p)$, $\alpha = 1, \dots, q$. Let $X = \mathbb{R}^p$ and $U = \mathbb{R}^q$ be the spaces of independent and dependent variables with coordinates $\{x^i\}$ and $\{u^\alpha\}$, respectively. Roughly speaking, a symmetry group of the system \mathcal{S} will be a local group of transformations that map solutions of \mathcal{S} into solutions of \mathcal{S} .

Historical Notes

Marius Sophus Lie (1842–1899) was the youngest son of a Lutheran pastor in Norway. He studied mathematics and science at Christiania (which became Kristiania, then Oslo in 1925) University where he attended Sylow's lectures on group theory. There followed a few years when he could not decide what career to follow. He tutored privately after his graduation and even dabbled a bit in astronomy and mechanics.

A turning point came in 1868 when he read papers on geometry by Poncelet and Plücker from which originated the inspiration in the topic of creating geometries by using elements other than points in space, and provided the seed for the rest of Lie's career, prompting him to call himself a student of Plücker, even though the two had never met.

Lie's first publication won him a scholarship to work in Berlin, where he met Klein, who had also been influenced by Plücker's papers. The two had quite different styles—Lie always pursuing the broadest generalization, while Klein could become absorbed in a charming special case—but collaborated effectively for many years. However, in 1892 the lifelong friendship between Lie and Klein broke down, and the following year Lie publicly attacked Klein, saying, "I am no pupil of Klein, nor is the opposite the case, although this might be closer to the truth." Lie and Klein spent a summer in Paris, then parted for some time before resuming their collaboration in Germany. While in Paris, Lie discovered the *contact transformation*, which, for instance, maps lines into spheres. During the Franco-Prussian War, Lie decided to hike to Italy. On the way, however, he was arrested as a German spy and his mathematics notes were assumed to be coded messages. Only after the intervention of Darboux was Lie released, and he decided to return to Christiania. In 1871 Lie became an assistant at Christiania and obtained his doctorate.

After a short stay in Germany, he again returned to Christiania University, where a chair of mathematics was created for him. Several years later Lie succeeded Klein at Leipzig, where he was stricken with a condition, then called neurasthenia, resulting in fatigue and memory loss and once thought to result from exhaustion of the nervous system. Although treatment in a mental hospital nominally restored his health, the once robust and happy Lie became ill-tempered and suspicious, despite the recognition he received for his work. To lure him back to Norway, his friends at Christiania created another special chair for him, and Lie returned in the fall of 1898. He died of anemia a few months later. Lie had started examining partial differential equations, hoping that he could find a theory that was analogous to Galois's theory of equations. He examined his contact transformations considering how they affected a process due to Jacobi of generating further solutions from a given one. This led to combining the transformations in a way that Lie called a group, but is today called a *Lie algebra*. At this point he left his original intention of examining partial differential equations and examined Lie algebras. Killing was to examine Lie algebras quite independently of Lie, and Cartan was to publish the classification of semisimple Lie algebras in 1900. Much of the work on transformation groups for which Lie is best known was collected with the aid of a postdoctoral student sent to Christiania by Klein in 1884. The student, F. Engel, remained nine months with Lie and was instrumental in the production of the three volume work *Theorie der Transformationsgruppen*, which appeared between 1888 and 1893. A similar effort to collect Lie's work in contact transformations and partial differential equations was sidetracked as Lie's coworker, F. Hausdorff, pursued other topics.

The transformation groups now known as **Lie groups** provided a very fertile area for research for decades to come, although perhaps not at first. When Killing tried to classify the simple Lie groups, Lie considered his efforts so poor that he admonished one of his departing students with these words: "Farewell, and if ever you meet that s.o.b., kill him." Lie's work was continued (somewhat in isolation) by Cartan, but it was the papers of Weyl in the early 1920s that sparked the renewal of strong interest in Lie groups. Much of the foundation of the quantum theory of fundamental processes is built on Lie groups. In 1939, Wigner showed that application of Lie algebras to the Lorentz transformation required that all particles have the intrinsic properties of mass and spin.

To make precise the above statement, we have to clarify the meaning of the action of G on a function $u = f(x)$. We start with identifying the function f (i.e., a map) with its graph (see Chap. 1),

$$\Gamma_f \equiv \{(x, f(x)) \mid x \in \Omega\} \subset X \times U,$$

where $\Omega \subset X$ is the domain of definition of f . If the action of $g \in G$ on Γ_f is defined, then the transform of Γ_f by g is

$$g \cdot \Gamma_f = \{(\tilde{x}, \tilde{u}) = g \cdot (x, u) \mid (x, u) \in \Gamma_f\}.$$

In general, $g \cdot \Gamma_f$ may not represent the graph of a function—in fact, it may not be even a function at all. However, by choosing g close to the identity



Marius Sophus Lie
1842–1899

transform the *graph* of a function to find the function's transform!

transform of a function by a group element

of G and shrinking the size of Ω , we can ensure that $g \cdot \Gamma_f = \Gamma_{\tilde{f}}$, i.e., that $g \cdot \Gamma_f$ is indeed the graph of a function $\tilde{u} = \tilde{f}(\tilde{x})$. We write $\tilde{f} = g \cdot f$ and call \tilde{f} the **transform** of f by g .

Example 32.2.1 Let $X = \mathbb{R} = U$, so that we are dealing with an ODE. Let $G = SO(2)$ be the rotation group acting on $X \times U = \mathbb{R}^2$. The action is given by

$$(\tilde{x}, \tilde{u}) = \theta \cdot (x, u) = (x \cos \theta - u \sin \theta, x \sin \theta + u \cos \theta). \quad (32.6)$$

If $u = f(x)$ is a function, the group $SO(2)$ acts on its graph Γ_f by rotating it. This process can lead to a rotated graph $\theta \cdot \Gamma_f$, which may not be the graph of a single-valued function. However, if we restrict the interval of definition of f , and make θ small enough, then $\theta \cdot \Gamma_f$ will be the graph of a well-defined function $\tilde{u} = \tilde{f}(\tilde{x})$ with $\Gamma_{\tilde{f}} = \theta \cdot \Gamma_f$. If we substitute $f(x)$ for u , we obtain

$$(\tilde{x}, \tilde{u}) = \theta \cdot (x, f(x)) = (x \cos \theta - f(x) \sin \theta, x \sin \theta + f(x) \cos \theta),$$

or

$$\begin{aligned} \tilde{x} &= x \cos \theta - f(x) \sin \theta, \\ \tilde{u} &= x \sin \theta + f(x) \cos \theta. \end{aligned} \quad (32.7)$$

Eliminating x from these two equations yields \tilde{u} in terms of \tilde{x} , from which the function \tilde{f} can be deduced.

As a specific example, consider $f(x) = kx^2$. Then, the first equation of (32.7) gives

$$(k \sin \theta)x^2 - \cos \theta x + \tilde{x} = 0 \quad \Rightarrow \quad x = \frac{\cos \theta - \sqrt{\cos^2 \theta - 4k\tilde{x} \sin \theta}}{2k \sin \theta},$$

where we kept the root of the quadratic equation that gives a finite answer in the limit $\theta \rightarrow 0$. Inserting this in the second equation of (32.7) and simplifying yields

$$\tilde{u} = \tilde{f}(\tilde{x}) = \frac{\cos \theta - \sqrt{\cos^2 \theta - 4k\tilde{x} \sin \theta}}{2k \sin^2 \theta} - \tilde{x} \cot \theta.$$

We write this as

$$\tilde{f}(x) \equiv (\theta \cdot f)(x) = \frac{\cos \theta - \sqrt{\cos^2 \theta - 4kx \sin \theta}}{2k \sin^2 \theta} - x \cot \theta.$$

This equation defines the function $\tilde{f} = \theta \cdot f$.

The foregoing example illustrates the general procedure for finding the transformed function $\tilde{f} = g \cdot f$:

Box 32.2.2 *If the rule of transformation of $g \in G$ is given by*

$$(\tilde{x}, \tilde{u}) = g \cdot (x, u) = (\Psi_g(x, u), \Phi_g(x, u)),$$

then the graph $\Gamma_{\tilde{f}} = g \cdot \Gamma_f$ of $g \cdot f$ is given parametrically by

$$\tilde{x} = \Psi_g(x, f(x)), \quad \tilde{u} = \Phi_g(x, f(x)). \quad (32.8)$$

In principle, we can solve the first equation for x in terms of \tilde{x} and substitute in the second equation to find \tilde{u} in terms \tilde{x} , and consequently \tilde{f} .

For some special but important cases, the transformed functions can be obtained explicitly. If G is **projectable**, i.e., if the action of G on x does not depend on u , then Eq. (32.8) takes the special form $\tilde{x} = \Psi_g(x)$ and $\tilde{u} = \Phi_g(x, f(x))$ in which Ψ_g is a diffeomorphism of X with inverse $\Psi_{g^{-1}}$. If Γ_f is the graph of a function f , then its transform $g \cdot \Gamma$ is *always* the graph of some function. In fact,

$$\tilde{u} = \tilde{f}(\tilde{x}) = \Phi_g(x, f(x)) = \Phi_g(\Psi_{g^{-1}}(\tilde{x}), f(\Psi_{g^{-1}}(\tilde{x}))). \quad (32.9)$$

In particular, if G transforms *only the independent variables*, then

$$\tilde{u} = \tilde{f}(\tilde{x}) = f(x) = f(\Psi_{g^{-1}}(\tilde{x})) \Rightarrow \tilde{f} = f \circ \Psi_{g^{-1}}. \quad (32.10)$$

For example, if G is the group of translations $x \mapsto x + a$, then the transform of f will be defined by $\tilde{f}(x) = f(x - a)$.

Definition 32.2.3 A **symmetry group** of a system of DEs \mathcal{S} is a local group of transformations G acting on an open subset M of $X \times U$ with the property that whenever $u = f(x)$ is a solution of \mathcal{S} and $\tilde{f} \equiv g \cdot f$ is defined for $g \in G$, then $u = \tilde{f}(x)$ is also a solution of \mathcal{S} .

The importance of knowing the symmetry group of a system of DEs lies in the property that from one solution we may be able to obtain a family of other solutions by applying the group elements to the given solution. To find such symmetry groups, we have to be able to “prolong” the action of a group to derivatives of the dependent variables as well. This is obvious because to test a symmetry, we have to substitute not only the transformed function $u = \tilde{f}(x)$, but also its derivatives in the DE to verify that it satisfies the DE.

32.2.1 Prolongation of Functions

Given a function $f : \mathbb{R}^p \supset X \rightarrow \mathbb{R}$, there are

$$p_k \equiv \binom{p+k-1}{k}$$

different derivatives of order k of f . We use the multi-index notation

$$\partial_{J^{(k)}} f(x) \equiv \frac{\partial^k f(x)}{\partial x^{j_1} \partial x^{j_2} \dots \partial x^{j_k}}$$

for these derivatives, where $J^{(k)} \equiv (j_1, \dots, j_k) \in \mathbb{N}^k$ is an *unordered* k -tuple of nonnegative integers with $1 \leq j_k \leq p$ (see also Sect. 21.1).¹ The *order* of the multi-index $J^{(k)}$, denoted by $|J^{(k)}|$, is the sum of its components and indicates the order of differentiation. So, in the derivative above, $|J^{(k)}| = j_1 + \dots + j_k = k$. For a smooth map $f : X \rightarrow U$, we have $f(x) = (f^1(x), \dots, f^q(x))$, so that we need $q \cdot p_k$ numbers to represent all k -th order derivatives $\partial_{J^{(k)}} f^\alpha(x)$ of all components of f . We include the case of $k = 0$, in which case $\partial_{J^{(0)}} f^\alpha(x) = f^\alpha(x)$.

To geometrize the treatment of DEs (and thus facilitate the study of their invariance), we need to construct a space in which derivatives of all orders up to a certain number n participate. Since derivatives need functions to act on, we arrive at the space of functions whose derivatives share certain common properties. To be specific, we make the following definition.

Definition 32.2.4 Let f and h be functions defined on a neighborhood of a point $a \in X$ with values in U . We say that f and h are **n -equivalent** at a if $\partial_{J^{(k)}} f^\alpha(a) = \partial_{J^{(k)}} h^\alpha(a)$ for all α and $k = 0, 1, \dots, n$. The collection of all U -valued functions defined on a neighborhood of a will be denoted by $\Gamma_a(X \times U)$, and all functions n -equivalent to f at a by $J_a^n f$.

A convenient representative of such equivalent functions is the Taylor polynomial of order n (the terms in the Taylor series up to n th order) about a . Now collect all $J_a^n f$ for all a and f , and denote the result by $J^n(X \times U)$, so that

$$J^n(X \times U) \equiv \{J_a^n f \mid \forall a \in X \text{ and } \forall f \in \Gamma_a(X \times U)\}. \tag{32.11}$$

$J^n(X \times U)$ is called the **n th prolongation** of U , or the **n th jet space** of U . It turns out that $J^n(X \times U)$ is a manifold (see [Saun 89, pp. 98 and 199]).

Theorem 32.2.5 $J^n(X \times U)$ is a manifold with **natural coordinate functions** $(x^i, \{u_{J^{(k)}}^\alpha\}_{k=1}^n) \equiv (x^i, u_j^\alpha)$ defined by

$$x^i(J_a^n f) = a^i, \quad u_{J^{(k)}}^\alpha(J_a^n f) = \partial_{J^{(k)}} f^\alpha(a), \quad k = 0, 1, \dots, n.$$

Note that the “points” of $J^n(X \times U)$ are U -valued functions!

The natural coordinate functions allow us to identify the space of the derivatives with various powers of \mathbb{R} . Let $U_k \equiv \mathbb{R}^{qp_k}$ denote the set of coordinates $u_{J^{(k)}}^\alpha$, and let $U^{(n)} \equiv U \times U_1 \times \dots \times U_n$ be the Cartesian product space² whose coordinates represent all the derivatives $u_{J^{(k)}}^\alpha$ of all orders

¹We shall usually omit the superscript (k) in $J^{(k)}$ when it is understood that all orders of $J^{(k)}$ up to a certain given number are involved.

²Note that U , identified with the space of zeroth derivative, is a factor in $U^{(n)}$.

from 0 to n . The dimension of $U^{(n)}$ is

$$q + qp_1 + \dots + qp_n = q \binom{p+n}{n} \equiv qp^{(n)}.$$

A typical point in $U^{(n)}$ is denoted by $u^{(n)}$, which has $qp^{(n)}$ different components $\{u_{j^{(k)}}^\alpha\}_{\alpha=1}^q$, where $J^{(k)}$ runs over all unordered multi-indices $J^{(k)} = (j_1, \dots, j_k)$ with $1 \leq j_k \leq p$ and $0 \leq k \leq n$. The n th jet space $J^n(X \times U)$ can now be identified with $X \times U^{(n)}$. From now on, we shall use $X \times U^{(n)}$ in place of $J^n(X \times U)$.

Example 32.2.6 Let $p = 3$ and $u = 1$, i.e., $X = \mathbb{R}^3$ and $U = \mathbb{R}$. The coordinates of X are (x, y, z) and that of U is u . The coordinates of U_1 are (u_x, u_y, u_z) , where the subscript denotes the variable of differentiation. Similarly, the coordinates of U_2 are

$$(u_{xx}, u_{xy}, u_{xz}, u_{yy}, u_{yz}, u_{zz})$$

and those of $U^{(2)} \equiv U \times U_1 \times U_2$ are

$$(u; u_x, u_y, u_z; u_{xx}, u_{xy}, u_{xz}, u_{yy}, u_{yz}, u_{zz}),$$

which shows that $U^{(2)}$ is 10-dimensional.

Definition 32.2.7 Given a smooth map $f : X \supset \Omega \rightarrow U$, we define a map $\text{pr}^{(n)} f : \Omega \rightarrow U^{(n)}$ whose components $(\text{pr}^{(n)} f)_j^\alpha$ are given by

$$(\text{pr}^{(n)} f)_j^\alpha(x) \equiv \partial_j f^\alpha(x) \equiv \left(\{\partial_{J^{(k)}} f^\alpha(x)\}_{k=0}^n \right)_j.$$

prolongation of a function

This map is called the n th **prolongation** of f .

Thus, for each $x \in X$, $\text{pr}^{(n)} f(x)$ is a vector in $\mathbb{R}^{qp^{(n)}}$ whose components are the values of f and all its derivatives up to order n at the point x . For example, in the case of $p = 3, q = 1$ discussed above, $\text{pr}^{(2)} f(x, y, z)$ has components

$$\left(f; \frac{\partial f}{\partial x}, \frac{\partial f}{\partial y}, \frac{\partial f}{\partial z}; \frac{\partial^2 f}{\partial x^2}, \frac{\partial^2 f}{\partial x \partial y}, \frac{\partial^2 f}{\partial x \partial z}, \frac{\partial^2 f}{\partial y^2}, \frac{\partial^2 f}{\partial y \partial z}, \frac{\partial^2 f}{\partial z^2} \right).$$

When the underlying space is an open subset M of $X \times U$, its corresponding jet space is

$$M^{(n)} \equiv M \times U_1 \times \dots \times U_n,$$

which is a subspace of $X \times U^{(n)} \cong J^n(X \times U)$. If the graph of $f : X \rightarrow U$ lies in M , the graph of $\text{pr}^{(n)} f$ lies in $M^{(n)}$.

Prolongation allows us to turn a system of DEs into a system of algebraic equations: Given a system of l DEs

$$\Delta_\nu(\{x^i\}, \{u^\alpha\}, \{\partial_i u^\alpha\}, \{\partial_i \partial_j u^\alpha\}, \dots, \{\partial_{i_1} \dots \partial_{i_n} u^\alpha\}) = 0, \quad \nu = 1, \dots, l,$$

one can define a map $\Delta : M^{(n)} \rightarrow \mathbb{R}^l$ and identify the system of DEs with

$$\mathcal{S}_\Delta \equiv \{(x, u^{(n)}) \in M^{(n)} \mid \Delta(x, u^{(n)}) = 0\}.$$

By identifying the system of DEs with the subset \mathcal{S}_Δ of the jet space, we have translated the abstract relations among the derivatives of u into a geometrical object \mathcal{S}_Δ , which is more amenable to symmetry operations.

Definition 32.2.8 Let Ω be a subset of X and $f : \Omega \rightarrow U$ a smooth map. Then f is called a **solution** of the system of DEs \mathcal{S}_Δ if

$$\Delta(x, \text{pr}^{(n)} f(x)) = 0 \quad \forall x \in \Omega.$$

Just as we identified a function with its graph, we can identify the solution of a system of DEs with the graph of its prolongation $\text{pr}^{(n)} f$. This graph, which is denoted by $\Gamma_f^{(n)}$, will clearly be a subset of \mathcal{S}_Δ :

$$\Gamma_f^{(n)} \equiv \{(x, \text{pr}^{(n)} f(x))\} \subset \mathcal{S}_\Delta.$$

Box 32.2.9 An n th order system of differential equations is taken to be a subset \mathcal{S}_Δ of the jet space $J^n(X \times U)$, and a solution to be a smooth map $f : \Omega \rightarrow J^n(X \times U)$ the graph of whose n th prolongation $\text{pr}^{(n)} f$ is contained in \mathcal{S}_Δ .

Example 32.2.10 Consider Laplace's equation

$$\nabla^2 u = u_{xx} + u_{yy} + u_{zz} = 0$$

with $p = 3$, $q = 1$, and $n = 2$. The total jet space is the 13-dimensional Euclidean space $X \times U^{(2)}$, whose coordinates are taken to be

$$(x, y, z; u; u_x, u_y, u_z; u_{xx}, u_{xy}, u_{xz}, u_{yy}, u_{yz}, u_{zz}).$$

In this 13-dimensional Euclidean space, Laplace's equation defines a 12-dimensional subspace \mathcal{S}_Δ consisting of all points in the jet space whose eighth, eleventh, and thirteenth coordinates add up to zero. A solution $f : \mathbb{R}^3 \supset \Omega \rightarrow U \subset \mathbb{R}$ must satisfy

$$\frac{\partial^2 f}{\partial x^2} + \frac{\partial^2 f}{\partial y^2} + \frac{\partial^2 f}{\partial z^2} = 0 \quad \forall (x, y, z) \in \Omega.$$

This is the same as requiring the graph $\Gamma_f^{(2)}$ to lie in \mathcal{S}_Δ . For example, if

$$f(\mathbf{r}) \equiv f(x, y, z) = x^3 yz - y^3 xz + y^3 - 3yz^2,$$

then, collecting each section of $\text{pr}^{(2)} f$ with fixed α (see Definition 32.2.7) separately, we have

$$(\text{pr}^{(2)} f)^1(\mathbf{r}) = x^3 yz - y^3 xz + y^3 - 3yz^2,$$

$$\begin{aligned}
(\text{pr}^{(2)} f)^2(\mathbf{r}) &= (3x^2yz - y^3z, x^3z - 3y^2xz + 3y^2 - 3z^2, x^3y - y^3x - 6yz), \\
(\text{pr}^{(2)} f)^3(\mathbf{r}) &= (6xyz, 3x^2z - 3y^2z, 3x^2y - y^3, \\
&\quad - 6xyz + 6y, x^3 - 3xy^2 - 6z, -6y)
\end{aligned}$$

which lies in \mathfrak{S}_Δ because the sum of the eighth, the eleventh, and the thirteenth coordinates of $(x, y, z; \text{pr}^{(2)} f(x, y, z))$ is $6xyz - 6xyz + 6y - 6y = 0$.

32.2.2 Prolongation of Groups

Suppose G is a group of transformations acting on $M \subset X \times U$. It is possible to prolong this action to the n -jet space $M^{(n)}$. The resulting group that acts on $M^{(n)}$ is called the n th **prolongation** of G and denoted by $\text{pr}^{(n)}G$ with group elements $\text{pr}^{(n)}g$, for $g \in G$. This prolongation is defined naturally: The derivatives of a function f with respect to x are transformed into derivatives of $\tilde{f} = g \cdot f$ with respect to \tilde{x} . More precisely,

$$\boxed{\text{pr}^{(n)}g \cdot (j_x^n f) \equiv (\tilde{x}, \text{pr}^{(n)}\tilde{f}(\tilde{x})) \equiv (\tilde{x}, \text{pr}^{(n)}(g \cdot f)(\tilde{x}))}. \quad (32.12)$$

For $n = 0$, Eq. (32.12) reduces to the action of G on M as given by Eq. (32.8). That the outcome of the action of the prolongation of G in the defining equation (32.12) is independent of the representative function f follows from the chain rule and the fact that only derivatives up to the n th order are involved. The following example illustrates this.

Example 32.2.11 Let X , U , and G be as in Example 32.2.1. In this case, we have

$$\text{pr}^{(1)}\theta \cdot (j_x^1 f) \equiv \text{pr}^{(1)}\theta \cdot (x, u, u_1) \equiv (\tilde{x}, \tilde{u}, \tilde{u}_1).$$

We calculated \tilde{x} and \tilde{u} in that example. They are

$$\begin{aligned}
\tilde{x} &= x \cos \theta - u \sin \theta, \\
\tilde{u} &= x \sin \theta + u \cos \theta.
\end{aligned} \quad (32.13)$$

To find \tilde{u}_1 , we need to differentiate the second equation with respect to \tilde{x} and express the result in terms of the original variables. Thus

$$\tilde{u}_1 \equiv \frac{d\tilde{u}}{d\tilde{x}} = \frac{d\tilde{u}}{dx} \frac{dx}{d\tilde{x}} = \left(\sin \theta + \frac{du}{dx} \cos \theta \right) \frac{dx}{d\tilde{x}} = (\sin \theta + u_1 \cos \theta) \frac{dx}{d\tilde{x}};$$

$dx/d\tilde{x}$ is obtained by differentiating the first equation of (32.13):

$$1 = \frac{dx}{d\tilde{x}} \cos \theta - \frac{du}{d\tilde{x}} \sin \theta = \frac{dx}{d\tilde{x}} \cos \theta - \frac{du}{dx} \frac{dx}{d\tilde{x}} \sin \theta = (\cos \theta - u_1 \sin \theta) \frac{dx}{d\tilde{x}},$$

or

$$\frac{dx}{d\tilde{x}} = \frac{1}{\cos \theta - u_1 \sin \theta}.$$

It therefore follows that

$$\tilde{u}_1 = \frac{\sin \theta + u_1 \cos \theta}{\cos \theta - u_1 \sin \theta}$$

and

$$\text{pr}^{(1)}\theta \cdot (x, u, u_1) = \left(x \cos \theta - u \sin \theta, x \sin \theta + u \cos \theta, \frac{\sin \theta + u_1 \cos \theta}{\cos \theta - u_1 \sin \theta} \right).$$

We note that the RHS involves derivatives up to order one. Therefore, the transformation is independent of the representative function. So, if we had chosen $j_x^1 h$ where h is 1-equivalent to f , we would have obtained the same result. This holds for derivatives of all orders. Therefore, the prolongation of the action of the group G is well-defined.

In many cases, it is convenient to choose the n th-order Taylor polynomial as the representative of the class of n -equivalent functions, and, if possible, write the transformed function \tilde{f} explicitly in terms of \tilde{x} , and differentiate it to obtain the transformed derivatives (see Problem 32.3).

Example 32.2.11 illustrates an important property of the prolongation of G . We note that the first prolongation $\text{pr}^{(1)}G$ acts on the original coordinates (x, u) in exactly the same way that G does. This holds in general:

Box 32.2.12 *The effect of the n th prolongation $\text{pr}^{(n)}G$ to derivatives up to order $m \leq n$ is exactly the same as the effect of $\text{pr}^{(m)}G$. If we already know the action of the m th-order prolonged group $\text{pr}^{(m)}G$, then to compute $\text{pr}^{(n)}G$ we need only find how the derivatives u_j^α of order higher than m transform, because the lower-order action is already determined.*

32.2.3 Prolongation of Vector Fields

The geometrization of a system of DEs makes it possible to use the machinery of differentiable manifolds, Lie groups, and Lie algebras to unravel the symmetries of the system. At the heart of this machinery are the infinitesimal transformations, which are directly connected to vector fields. Therefore, it is necessary to find out how a vector field defined in $M \subset X \times U$ is prolonged. The most natural way to prolong a vector field is to prolong its integral curve—which is a one-parameter group of transformations of M —to a curve in $M^{(n)}$ and then calculate the tangent to the latter curve.

n th prolongation of a vector field **Definition 32.2.13** Let M be an open subset of $X \times U$ and $\mathbf{X} \in \mathcal{X}(M)$. The n th prolongation of \mathbf{X} , denoted by $\text{pr}^{(n)}\mathbf{X}$, is a vector field on the n th jet

space $M^{(n)}$ defined by

$$\text{pr}^{(n)}\mathbf{X}|_{(x,u^{(n)})} = \frac{d}{dt}\text{pr}^{(n)}[\exp(t\mathbf{X})] \cdot (x, u^{(n)})|_{t=0}$$

for any $(x, u^{(n)}) \in M^{(n)}$.

Since $(x, u^{(n)}) \in M^{(n)}$ form a coordinate system on $M^{(n)}$, any vector field in $M^{(n)}$ can be written as a linear combination of $\partial/\partial x^i$ and $\partial/\partial u_j^\alpha$ with coefficients being, in general, functions of *all* coordinates x^i and u_j^α . For a prolonged vector, however, we have

$$\text{pr}^{(n)}\mathbf{X} = \sum_{i=1}^p X^i \frac{\partial}{\partial x^i} + \sum_{\alpha=1}^q \sum_J X_J^\alpha \frac{\partial}{\partial u_J^\alpha}, \quad (32.14)$$

where X^i and X_0^α are functions only of x^k and u . This is due to the remark made in Box 32.2.12. For the same reason, the coefficients $X_{J(m)}^\alpha$ corresponding to derivatives of order m will be independent of coordinates $u_{J(k)}^\alpha$ for $k > m$. Thus, it is possible to construct various prolongations of a given vector field recursively.

Example 32.2.14 Let us consider our recurrent example of $X \cong U \cong \mathbb{R}$, $G = SO(2)$. Given the infinitesimal generator $\mathbf{v} = -u\partial_x + x\partial_u$, one can solve the DE of its integral curve to obtain³

$$\exp(t\mathbf{v})(x, u) = (x \cos t - u \sin t, x \sin t + u \cos t).$$

Example 32.2.11 calculated the first prolongation of $SO(2)$. So

$$\begin{aligned} &\text{pr}^{(1)} \exp(t\mathbf{v}) \cdot (x, u, u_1) \\ &= \left(x \cos t - u \sin t, x \sin t + u \cos t, \frac{\sin t + u_1 \cos t}{\cos t - u_1 \sin t} \right). \end{aligned}$$

Differentiating the components with respect to t at $t = 0$ gives

$$\begin{aligned} \left. \frac{\partial}{\partial t} (x \cos t - u \sin t) \right|_{t=0} &= -u, \\ \left. \frac{\partial}{\partial t} (x \sin t + u \cos t) \right|_{t=0} &= x, \\ \left. \frac{\partial}{\partial t} \left(\frac{\sin t + u_1 \cos t}{\cos t - u_1 \sin t} \right) \right|_{t=0} &= 1 + u_1^2. \end{aligned}$$

Therefore,

$$\text{pr}^{(1)}\mathbf{v} = -u \frac{\partial}{\partial x} + x \frac{\partial}{\partial u} + (1 + u_1^2) \frac{\partial}{\partial u_1}.$$

Note that the first two terms in $\text{pr}^{(1)}\mathbf{v}$ are the same as those in \mathbf{v} itself, in agreement with Box 32.2.12.

³One can, of course, also write the finite group element directly.

32.3 The Central Theorems

We are now in a position to state the first central theorem of the application of Lie groups to the solution of DEs. This theorem is the exact replica of Theorem 32.1.6 in the language of prolongations:

Theorem 32.3.1 *Let $\{\Delta_v(x, u^{(n)}) = 0\}_{v=1}^l$ be a system of DEs defined on $M \subset X \times U$ whose Jacobian matrix*

$$J_\Delta(x, u^{(n)}) \equiv \left(\frac{\partial \Delta_v}{\partial x^i}, \frac{\partial \Delta_v}{\partial u^\alpha} \right)$$

has rank l for all $(x, u^{(n)}) \in \mathcal{S}_\Delta$. If G is a local Lie group of transformations acting on M , and

$$\text{pr}^{(n)} \xi_M|_{(x, u^{(n)})} \Delta_v = 0, \quad v = 1, \dots, l, \text{ whenever } \Delta(x, u^{(n)}) = 0$$

for every infinitesimal generator ξ of G , then G is the symmetry group of the system.

Example 32.3.2 Consider the first order (so, $n = 1$) ordinary DE

$$\Delta(x, u, u_1) = (u - x^3 - u^2x)u_1 + x + x^2u + u^3 = 0,$$

so that $X \cong \mathbb{R}$ and $U \cong \mathbb{R}$. We first note that

$$\begin{aligned} J_\Delta &= \left(\frac{\partial \Delta}{\partial x}, \frac{\partial \Delta}{\partial u}, \frac{\partial \Delta}{\partial u_1} \right) \\ &= ((-3x^2 - u^2)u_1 + 1 + 2xu, (1 - 2ux)u_1 + x^2 + 3u^2, u - x^3 - u^2x), \end{aligned}$$

which is of rank 1 everywhere. Now let us apply the first prolongation of the generator of $SO(2)$ —calculated in Example 32.2.14—to Δ . We have

$$\begin{aligned} \text{pr}^{(1)} \mathbf{v}(\Delta) &= -u \frac{\partial \Delta}{\partial x} + x \frac{\partial \Delta}{\partial u} + (1 + u_1^2) \frac{\partial \Delta}{\partial u_1} \\ &= -u[(-3x^2 - u^2)u_1 + 1 + 2xu] + x[(1 - 2ux)u_1 + x^2 + 3u^2] \\ &\quad + (1 + u_1^2)(u - x^3 - u^2x) \\ &= u_1[(u - x^3 - u^2x)u_1 + x + x^2u + u^3] = u_1 \Delta. \end{aligned}$$

It follows that $\text{pr}^{(1)} \mathbf{v}(\Delta) = 0$ whenever $\Delta = 0$, and that $SO(2)$ is a symmetry group of the DE. Thus, rotations will change solutions of the DE into other solutions. In fact, the reader may verify that in polar coordinates, the DE can be written in the incredibly simple form

$$\frac{dr}{d\theta} = r^3,$$

and the symmetry of the DE conveys the fact that adding a constant to θ does not change the polar form of the DE.

Theorem 32.3.1 reduces the invariance of a system of DEs to a criterion involving the prolongation of the infinitesimal generators of the symmetry group. The urgent task in front of us is therefore to construct an explicit formula for the prolongation of a vector field. In order to gain insight into this construction, we first look at the simpler case of $U \cong \mathbb{R}$ and a group G that transforms only the independent variables. Furthermore, we restrict ourselves to the first prolongation. An infinitesimal generator of such a group will be of the form

$$\mathbf{v} = \sum_{i=1}^p X^i(x) \frac{\partial}{\partial x^i},$$

which is assumed to act on the space $M \subset X \times U$. The integral curve of this vector field is $\exp(t\mathbf{v})$ which acts on points of M as follows:

$$(\tilde{x}, \tilde{u}) = \exp(t\mathbf{v}) \cdot (x, u) \equiv (\Psi_t(x), u) \equiv (\Psi_t^i(x), u).$$

By the construction of the integral curves in general, we have

$$\left. \frac{d\Psi_t^i(x)}{dt} \right|_{t=0} = X^i(x). \quad (32.15)$$

Denote the coordinates of the first jet space $M^{(1)}$ by (x^i, u, u_k) , where $u_k(j_x^1 f) \equiv \partial f / \partial x^k$. By the definition of the action of the prolonged group,

$$\text{pr}^{(1)} \exp(t\mathbf{v}) \cdot (j_x^1 f) = (\Psi_t(x), u, \tilde{u}_j), \quad (32.16)$$

where $u = f(x)$ and $\tilde{u}_j = \partial \tilde{f} / \partial \tilde{x}^j$. Once we find \tilde{u}_j , we can differentiate Eq. (32.16) with respect to t at $t = 0$ to obtain the prolonged vector field. Using Eq. (32.10) and commas to indicate differentiation,⁴ we obtain

$$\begin{aligned} \tilde{u}_j &= \tilde{f}_{,j}(\tilde{x}) = (f \circ \Psi_{-t})_{,j}(\tilde{x}) = \sum_{i=1}^p f_{,i}(\underbrace{\Psi_{-t}(\tilde{x})}_{=x}) \Psi_{-t,j}^i(\tilde{x}) \\ &= \sum_{i=1}^p u_i \Psi_{-t,j}^i(\tilde{x}). \end{aligned}$$

⁴We have found it exceedingly convenient to use commas to indicate differentiation with respect to the x 's. The alternative, i.e., the use of partials, makes it almost impossible to find one's way in the maze of derivatives involving x^i , \tilde{x}^j , and t , with \tilde{x}^j depending on t . The reader will recall that the index after the comma is to be thought of as a "position holder", and the argument as a substitution. Thus, for example,

$$\tilde{f}_{,j}(\tilde{x}) \equiv \left. \frac{\partial \tilde{f}(r_1, \dots, r_p)}{\partial r_j} \right|_{r=\tilde{x}} \equiv \left. \frac{\partial \tilde{f}(s_1, \dots, s_p)}{\partial s_j} \right|_{s=\tilde{x}} \equiv \left. \frac{\partial \tilde{f}(\heartsuit_1, \dots, \heartsuit_p)}{\partial \heartsuit_j} \right|_{\heartsuit=\tilde{x}}.$$

Since \mathbf{v} does not have any component along $\partial/\partial u$, its prolongation will not have such components either. The components U_j along $\partial/\partial u_j$ are obtained by differentiating \tilde{u}_j with respect to t :

$$\begin{aligned} U_j(x, u, u_j) &= \sum_{i=1}^p u_i \frac{d}{dt} \Psi_{-t,j}^i(\tilde{x}) \Big|_{t=0} \\ &= \sum_{i=1}^p u_i \frac{\partial \Psi_{-t,j}^i(\tilde{x})}{\partial t} \Big|_{t=0} + \sum_{i=1}^p u_i \sum_{k=1}^p \left(\Psi_{-t,jk}^i(\tilde{x}) \frac{\partial \tilde{x}^k}{\partial t} \right) \Big|_{t=0}. \end{aligned} \quad (32.17)$$

The derivative of the first term in the sum can be evaluated as follows:

$$\begin{aligned} \frac{\partial \Psi_{-t,j}^i(\tilde{x}(t))}{\partial t} \Big|_{t=0} &= - \frac{\partial \Psi_{s,j}^i(\tilde{x}(-s))}{\partial s} \Big|_{s=0} \equiv - \frac{\partial \Psi_{s,j}^i(s, \tilde{x}(-s))}{\partial s} \Big|_{s=0} \\ &= - \frac{\partial \Psi_{s,j}^i(s, \tilde{x}(0))}{\partial s} \Big|_{s=0} = - \frac{\partial \Psi_{s,j}^i(s, x)}{\partial s} \Big|_{s=0} \\ &= - \frac{\partial \Psi_{s,j}^i(x)}{\partial s} \Big|_{s=0} = - \left(\frac{\partial \Psi_s^i}{\partial s} \Big|_{s=0} \right)_{,j} (x) = -X_{,j}^i(x), \end{aligned}$$

where we have emphasized the dependence of \tilde{x} on t (or s), treated s as the first independent variable, and in the second line substituted $s = 0$ in all \tilde{x} 's before differentiation. This is possible because we are taking the *partial* derivative with respect to the first variable holding all others constant. The derivative of the second term in Eq. (32.17) can be calculated similarly:

$$\Psi_{-t,jk}^i(\tilde{x}(t)) \Big|_{t=0} = \Psi_{0,jk}^i(\tilde{x}(0)) = \frac{\partial^2 x^i}{\partial x^j \partial x^k} = 0$$

because $\Psi_0^i = x^i$. We therefore have

$$U_j(x, u, u_k) = - \sum_{i=1}^p \frac{\partial X^i}{\partial x^j} u_i \quad (32.18)$$

and

$$\text{pr}^{(1)} \mathbf{v} = \sum_{i=1}^p \left(X^i \frac{\partial}{\partial x^i} + U_i \frac{\partial}{\partial u_i} \right) = \mathbf{v} - \sum_{i,k=1}^p \frac{\partial X^k}{\partial x^i} u_k \frac{\partial}{\partial u_i}. \quad (32.19)$$

It is also instructive to consider the case in which U is still \mathbb{R} , but G acts only on the dependent variable. Then $\mathbf{v} = U(x, u)\partial_u$, and

$$(\tilde{x}, \tilde{u}) = (x, \Phi_t(x, u)), \quad \text{with} \quad U(x, u) = \frac{d\Phi_t(x, u)}{dt} \Big|_{t=0}.$$

The reader may check that in this case, the prolongation of \mathbf{v} is given by

$$\text{pr}^{(1)}\mathbf{v} = \mathbf{v} + \sum_{j=1}^p U_j(x, u^{(1)}) \frac{\partial}{\partial u_j}, \quad U_j(x, u^{(1)}) = \frac{\partial U}{\partial x^j} + u_j \frac{\partial U}{\partial u}. \tag{32.20}$$

The second equation in (32.20) can also be written as

$$U_j(x, \text{pr}^{(1)} f(x)) = \frac{\partial U}{\partial x^j} + \frac{\partial U}{\partial u} \frac{\partial f}{\partial x^j} = \frac{\partial}{\partial x^j} [U(x, f(x))].$$

In other words, $U_j(x, u^{(1)})$ is obtained from $U(x, u)$ by differentiation with respect to x^j , while treating u as a function of x . This leads us to the definition of the total derivative.

Definition 32.3.3 Let $S : M^{(n)} \rightarrow \mathbb{R}$ be a smooth function of x, u , and all derivatives of u up to n th order. The **total derivative** of S with respect to x^i , denoted by $D_i S$, is a smooth function $D_i S : M^{(n+1)} \rightarrow \mathbb{R}$ defined by total derivative

$$D_i S(j_x^{n+1} f) = \frac{\partial}{\partial x^i} [S(x, \text{pr}^{(n)} f(x))];$$

i.e., $D_i S$ is obtained from S by differentiating S with respect to x^i , treating u and all the u^α 's as functions of x .

The following proposition, whose proof is a straightforward application of the chain rule, gives the explicit formula for calculating the total derivative:

Proposition 32.3.4 The i th total derivative of $S : M^{(n)} \rightarrow \mathbb{R}$ is of the form

$$D_i S = \frac{\partial S}{\partial x^i} + \sum_{\alpha=1}^q \sum_J u_{J,i}^\alpha \frac{\partial S}{\partial u_J^\alpha}$$

where, for $J = (j_1, \dots, j_k)$,

$$u_{J,i}^\alpha \equiv \frac{\partial u_J^\alpha}{\partial x^i} = \frac{\partial^{k+1} u^\alpha}{\partial x^i \partial x^{j_1} \dots \partial x^{j_k}}$$

and the sum over J includes derivatives of all orders from 0 to n .

An immediate consequence of this proposition is

$$D_i u_J^\alpha = u_{J,i}^\alpha = \frac{\partial u_J^\alpha}{\partial x^i} \quad \forall J, \alpha, \tag{32.21}$$

$$D_i(ST) = T D_i S + S D_i T.$$

Higher-order total derivatives are defined in analogy with partial derivatives: If I is a multi-index of the form $I = (i_1, \dots, i_k)$, then the I th total derivative is

$$D_I S = D_{i_1} D_{i_2} \dots D_{i_k} S. \tag{32.22}$$

As in the case of partial derivatives, the order of differentiation is immaterial.

We are now ready to state the second central theorem of the application of Lie groups to the solution of DEs (for a proof, see [Olve 86, pp. 113–115]).

Theorem 32.3.5 *Let*

$$\mathbf{v} = \sum_{i=1}^p X^i(x, u) \frac{\partial}{\partial x^i} + \sum_{\alpha=1}^q U^\alpha(x, u) \frac{\partial}{\partial u^\alpha}$$

be a vector field on an open subset $M \subset X \times U$. The n th prolongation of \mathbf{v} , i.e., $\text{pr}^{(n)}\mathbf{v} \in \mathcal{X}(M^{(n)})$, is

$$\text{pr}^{(n)}\mathbf{v} = \mathbf{v} + \sum_{\alpha=1}^q \sum_J U_J^\alpha(x, u^{(n)}) \frac{\partial}{\partial u_J^\alpha},$$

where for $J = (j_1, \dots, j_k)$, the inner sum extends over $1 \leq |J| \leq n$ and the coefficients U_J^α are given by

$$U_J^\alpha(x, u^{(n)}) = D_J \left(U^\alpha - \sum_{i=1}^p X^i \frac{\partial u^\alpha}{\partial x^i} \right) + \sum_{i=1}^p X^i \frac{\partial u_J^\alpha}{\partial x^i}$$

and the higher-order derivative D_J is as given in Eq. (32.22).

Example 32.3.6 Let $p = 2$, $q = 1$, and consider the case in which G acts only on the independent variables (x, y) . The general vector field for this situation is

$$\mathbf{v} = \xi(x, y) \frac{\partial}{\partial x} + \eta(x, y) \frac{\partial}{\partial y}.$$

We are interested in the first prolongation of this vector field. Thus, $n = 1$, $X^1 = \xi$, $X^2 = \eta$, and J has only one component, which we denote by j (also written as x or y). Theorem 32.3.5 gives

$$U_j^\alpha \equiv U_j = -D_j \sum_{i=1}^2 X^i \frac{\partial u^\alpha}{\partial x^i} + \sum_{i=1}^2 X^i \frac{\partial u_j^\alpha}{\partial x^i} = - \sum_{i=1}^2 \frac{\partial X^i}{\partial x^j} \frac{\partial u^\alpha}{\partial x^i},$$

and using the notation $u_x = \partial u / \partial x$ and $u_y = \partial u / \partial y$, we obtain

$$\text{pr}^{(1)}\mathbf{v} = \mathbf{v} + U_x \frac{\partial}{\partial u_x} + U_y \frac{\partial}{\partial u_y}, \quad (32.23)$$

where

$$U_x = -u_x \frac{\partial \xi}{\partial x} - u_y \frac{\partial \eta}{\partial x} \quad \text{and} \quad U_y = -u_x \frac{\partial \xi}{\partial y} - u_y \frac{\partial \eta}{\partial y}.$$

In particular, if $G = SO(2)$, so that $\mathbf{v} = -y\partial_x + x\partial_y$, then $U_x = -u_y$ and $U_y = u_x$. It then follows that

$$\text{pr}^{(1)}\mathbf{v} = -y \frac{\partial}{\partial x} + x \frac{\partial}{\partial y} - u_y \frac{\partial}{\partial u_x} + u_x \frac{\partial}{\partial u_y}.$$

Example 32.3.7 Let $p = 1$, $q = 1$, and $G = SO(2)$. The general vector field for this situation is

$$\mathbf{v} = -u \frac{\partial}{\partial x} + x \frac{\partial}{\partial u}.$$

For the first prolongation of this vector field $n = 1$, $X^1 = -u$, and J has only one component, which we denote by x . Theorem 32.3.5 gives

$$U_J^\alpha \equiv U_x = D_x(x - X^1 u_x) + X^1 u_{xx} = 1 - \frac{\partial X^1}{\partial x} u_x = 1 + u_x^2.$$

It follows that

$$\text{pr}^{(1)}\mathbf{v} = -u \frac{\partial}{\partial x} + x \frac{\partial}{\partial u} + (1 + u_x^2) \frac{\partial}{\partial u_x},$$

which is the result obtained in Example 32.2.14.

The second prolongation can be obtained as well. Once again we use Theorem 32.3.5 with obvious change of notation:

$$\begin{aligned} U_{xx} &= D_x D_x(x - X^1 u_x) + X^1 u_{xxx} = D_x(1 + u_x^2 + uu_{xx}) - uu_{xxx} \\ &= 3u_x u_{xx}. \end{aligned}$$

Then

$$\text{pr}^{(2)}\mathbf{v} = -u \frac{\partial}{\partial x} + x \frac{\partial}{\partial u} + (1 + u_x^2) \frac{\partial}{\partial u_x} + 3u_x u_{xx} \frac{\partial}{\partial u_{xx}}.$$

Using Theorem 32.3.1, we note that the DE $u_{xx} = 0$ has $SO(2)$ as a symmetry group, because with $\Delta(x, u, u_x, u_{xx}) \equiv u_{xx}$,

$$\text{pr}^{(2)}\mathbf{v}(\Delta) = -u \frac{\partial \Delta}{\partial x} + x \frac{\partial \Delta}{\partial u} + (1 + u_x^2) \frac{\partial \Delta}{\partial u_x} + 3u_x u_{xx} \frac{\partial \Delta}{\partial u_{xx}} = 3u_x u_{xx},$$

which vanishes whenever $\Delta(x, u, u_x, u_{xx})$ vanishes. This is the statement that rotations take straight lines to straight lines.

32.4 Application to Some Known PDEs

We have all the tools at our disposal to compute (in principle) the most general symmetry group of almost any system of PDEs. The coefficients U_J^α of the prolonged vector field $\text{pr}^{(n)}\mathbf{v}$ will be functions of the partial derivatives of the coefficients X^i and U^α of \mathbf{v} with respect to both x and u . The infinitesimal criterion of invariance as given in Theorem 32.3.1 will involve x , u , and the derivatives of u with respect to x , as well as X^i and U^α and their partial derivatives with respect to x and u . Using the system of PDEs, we can obtain some of the derivatives of the u 's in terms of the others. Substituting these relations in the equation of infinitesimal criterion, we get an equation involving u 's and powers of its derivatives that are to be treated as independent. We then equate the coefficients of these powers of partial derivatives of u to zero. This will result in a large number of elementary PDEs for the

defining equations for the symmetry group of a system of PDEs

coefficient functions X^i and U^α of \mathbf{v} , called the **defining equations** for the symmetry group of the given system of PDEs. In most applications, these defining equations can be solved, and the general solution will determine the most general infinitesimal symmetry of the system. The symmetry group itself can then be calculated by exponentiation of the vector fields, i.e., by finding their integral curves. In the remaining part of this section, we construct the symmetry groups of the heat and the wave equations.

32.4.1 The Heat Equation

The one-dimensional heat equation $u_t = u_{xx}$ corresponds to $p = 2, q = 1$, and $n = 2$. So it is determined by the vanishing of $\Delta(x, t, u^{(2)}) = u_t - u_{xx}$. The most general infinitesimal generator of symmetry appropriate for this equation can be written as

$$\mathbf{v} = \xi(x, t, u) \frac{\partial}{\partial x} + \tau(x, t, u) \frac{\partial}{\partial t} + \phi(x, t, u) \frac{\partial}{\partial u}, \tag{32.24}$$

which, as the reader may check (see Problem 32.11), has a second prolongation of the form

$$\text{pr}^{(2)}\mathbf{v} = \mathbf{v} + \phi^x \frac{\partial}{\partial u_x} + \phi^t \frac{\partial}{\partial u_t} + \phi^{xx} \frac{\partial}{\partial u_{xx}} + \phi^{xt} \frac{\partial}{\partial u_{xt}} + \phi^{tt} \frac{\partial}{\partial u_{tt}},$$

where, for example,

$$\begin{aligned} \phi^t &= \phi_t - \xi_t u_x + (\phi_u - \tau_t) u_t - \xi_u u_x u_t - \tau_u u_t^2 \\ \phi^{xx} &= \phi_{xx} + (2\phi_{xu} - \xi_{xx}) u_x - \tau_{xx} u_t + (\phi_{uu} - 2\xi_{xu}) u_x^2 \\ &\quad - 2\tau_{xu} u_x u_t - \xi_{uu} u_x^3 - \tau_{uu} u_x^2 u_t + (\phi_u - 2\xi_x) u_{xx} \\ &\quad - 2\tau_x u_{xt} - 3\xi_u u_x u_{xx} - \tau_u u_t u_{xx} - 2\tau_u u_x u_{xt}, \end{aligned} \tag{32.25}$$

and subscripts indicate partial derivatives. Theorem 32.3.1 now gives

$$\text{pr}^{(2)}\mathbf{v}(\Delta) = \phi^t - \phi^{xx} = 0 \quad \text{whenever } u_t = u_{xx} \tag{32.26}$$

as the infinitesimal criterion. Substituting (32.25) in (32.26), replacing u_t with u_{xx} in the resulting equation, and equating to zero the coefficients of the monomials in derivatives of u , we obtain a number of equations involving ξ, τ , and ϕ . These equations as well as the monomials of which they are coefficients are given in Table 32.1. Complicated as the defining equations may look, they are fairly easy to solve. From (d) and (f) we conclude that τ is a function of t only. Then (c) shows that ξ is independent of u , and (e) gives $2\xi_x = \tau_t$, or $\xi(x, t) = \frac{1}{2}\tau_t x + \eta(t)$, for some arbitrary function η . From (h) and the fact that ξ is independent of u we get $\phi_{uu} = 0$, or

$$\phi(x, t, u) = \alpha(x, t)u + \beta(x, t)$$

Table 32.1 The defining equations of the heat equation and the monomials that give rise to them

| Monomial | Coefficient equation | |
|----------------|-------------------------------------|-----|
| u_{xx}^2 | $0 = 0$ | (a) |
| $u_x^2 u_{xx}$ | $\tau_{uu} = 0$ | (b) |
| $u_x u_{xx}$ | $2\xi_u + 2\tau_{xu} = 0$ | (c) |
| $u_x u_{xt}$ | $2\tau_u = 0$ | (d) |
| u_{xx} | $2\xi_x + \tau_{xx} - \tau_t = 0$ | (e) |
| u_{xt} | $2\tau_x = 0$ | (f) |
| u_x^3 | $\xi_{uu} = 0$ | (g) |
| u_x^2 | $2\xi_{xu} - \phi_{uu} = 0$ | (h) |
| u_x | $\xi_{xx} - 2\phi_{xu} - \xi_t = 0$ | (i) |
| 1 | $\phi_t - \phi_{xx} = 0$ | (j) |

for some as yet undetermined functions α and β . Since ξ is linear in x , $\xi_{xx} = 0$, and (i) yields $\xi_t = -2\phi_{xu} = -2\alpha_x$, or

$$\frac{\partial \alpha}{\partial x} = -\frac{1}{2}\xi_t = -\frac{1}{4}\tau_{tt}x - \frac{1}{2}\eta_t \Rightarrow \alpha(x, t) = -\frac{1}{8}\tau_{tt}x^2 - \frac{1}{2}\eta_t x + \rho(t).$$

Finally, with $\phi_t = \alpha_t u + \beta_t$ and $\phi_{xx} = \alpha_{xx}u + \beta_{xx}$ (recall that when taking partial derivatives, u is considered independent of x and t), the last defining equation (j) gives $\alpha_t = \alpha_{xx}$ and $\beta_t = \beta_{xx}$, i.e., that α and β are to satisfy the heat equation. Substituting α in the heat equation, we obtain

$$-\frac{1}{8}\tau_{tt}x^2 - \frac{1}{2}\eta_{tt}x + \rho_t = -\frac{1}{4}\tau_{tt},$$

which must hold for all x and t . Therefore,

$$\tau_{ttt} = 0, \quad \eta_{tt} = 0, \quad \rho_t = -\frac{1}{4}\tau_{tt}.$$

These equations have the solution

$$\tau = c_1 t^2 + c_2 t + c_3, \quad \rho = -\frac{1}{2}c_1 t + c_4, \quad \eta = c_5 t + c_6.$$

It follows that $\alpha(x, t) = -\frac{1}{4}c_1 x^2 - \frac{1}{2}c_5 x - \frac{1}{2}c_1 t + c_4$ and

$$\xi(x, t) = \frac{1}{2}(2c_1 t + c_2)x + c_5 t + c_6,$$

$$\tau(t) = c_1 t^2 + c_2 t + c_3,$$

$$\phi(x, t, u) = \left(-\frac{1}{4}c_1 x^2 - \frac{1}{2}c_5 x - \frac{1}{2}c_1 t + c_4 \right) u + \beta(x, t).$$

Inserting in Eq. (32.24) yields

$$\begin{aligned}
\mathbf{v} &= \left[\frac{1}{2}(2c_1t + c_2)x + c_5t + c_6 \right] \frac{\partial}{\partial x} + (c_1t^2 + c_2t + c_3) \frac{\partial}{\partial t} \\
&\quad + \left[\left(-\frac{1}{4}c_1x^2 - \frac{1}{2}c_5x - \frac{1}{2}c_1t + c_4 \right) u + \beta(x, t) \right] \frac{\partial}{\partial u} \\
&= c_1 \left[xt \frac{\partial}{\partial x} + t^2 \frac{\partial}{\partial t} - \frac{1}{4}(2t + x^2)u \frac{\partial}{\partial u} \right] + c_2 \left(\frac{1}{2}x \frac{\partial}{\partial x} + t \frac{\partial}{\partial t} \right) \\
&\quad + c_3 \frac{\partial}{\partial t} + c_4 u \frac{\partial}{\partial u} + c_5 \left(t \frac{\partial}{\partial x} - \frac{1}{2}xu \frac{\partial}{\partial u} \right) + c_6 \frac{\partial}{\partial x} + \beta(x, t) \frac{\partial}{\partial u}.
\end{aligned}$$

Thus the Lie algebra of the infinitesimal symmetries of the heat equation is spanned by the six vector fields

$$\begin{aligned}
\mathbf{v}_1 &= \partial_x, & \mathbf{v}_2 &= \partial_t, & \mathbf{v}_3 &= u\partial_u, & \mathbf{v}_4 &= x\partial_x + 2t\partial_t, \\
\mathbf{v}_5 &= 2t\partial_x - xu\partial_u, & \mathbf{v}_6 &= 4tx\partial_x + 4t^2\partial_t - (x^2 + 2t)u\partial_u
\end{aligned} \tag{32.27}$$

and the infinite-dimensional subalgebra

$$\mathbf{v}_\beta = \beta(x, t)\partial_u,$$

where β is an arbitrary solution of the heat equation.

The one-parameter groups G_i generated by the \mathbf{v}_i can be found by solving the appropriate DEs for the integral curves. We show a sample calculation and leave the rest of the computation to the reader. Consider \mathbf{v}_5 , whose integral curve is given by the set of DEs

$$\frac{dx}{ds} = 2t, \quad \frac{dt}{ds} = 0, \quad \frac{du}{ds} = -xu.$$

The second equation shows that t is not affected by the group. So, $t = t_0$, where t_0 is the initial value of t . The first equation now gives

$$\frac{dx}{ds} = 2t_0 \Rightarrow x = 2t_0s + x_0,$$

and the last equation yields

$$\frac{du}{ds} = -(2t_0s + x_0)u \Rightarrow \frac{du}{u} = -(2t_0s + x_0)ds \Rightarrow u = u_0 e^{-t_0s^2 - x_0s}.$$

Changing the transformed coordinates to \tilde{x}^i and removing the subscript from the initial coordinates, we can write

$$\exp(\mathbf{v}_5s) \cdot (x, t, u) = (\tilde{x}, \tilde{t}, \tilde{u}) = (x + 2ts, t, ue^{-sx - s^2t}).$$

Table 32.2 gives the result of the action of $\exp(\mathbf{v}_i s)$ to (x, t, u) .

The symmetry groups G_1 and G_2 reflect the invariance of the heat equation under space and time translations. G_3 and G_β demonstrate the linearity of the heat equation: We can multiply solutions by constants and add solutions to get new solutions. The scaling symmetry is contained in G_4 , which shows that if you scale time by the square of the scaling of x , you obtain

Table 32.2 The transformations caused by the symmetry group of the heat equation

| Group element | Transformed coordinates $(\tilde{x}, \tilde{t}, \tilde{u})$ |
|--------------------------------------|---|
| $G_1 = \exp(\mathbf{v}_1 s)$ | $(x + s, t, u)$ |
| $G_2 = \exp(\mathbf{v}_2 s)$ | $(x, t + s, u)$ |
| $G_3 = \exp(\mathbf{v}_3 s)$ | $(x, t, e^s u)$ |
| $G_4 = \exp(\mathbf{v}_4 s)$ | $(e^s x, e^{2s} t, u)$ |
| $G_5 = \exp(\mathbf{v}_5 s)$ | $(x + 2ts, t, u e^{-sx - s^2 t})$ |
| $G_6 = \exp(\mathbf{v}_6 s)$ | $(\frac{x}{1-4st}, \frac{t}{1-4st}, u\sqrt{1-4st} \exp[\frac{-sx^2}{1-4st}])$ |
| $G_\beta = \exp(\mathbf{v}_\beta s)$ | $(x, t, u + s\beta(x, t))$ |

a new solution. G_5 is a Galilean boost to a moving frame. Finally, G_6 is a transformation that cannot be obtained from any physical principle. Since each group G_i is a one-parameter group of symmetries, if f is a solution of the heat equation, so are the functions $f_i \equiv G_i \cdot f$ for all i . These functions can be obtained from Eq. (32.8). As an illustration, we find f_6 . First note that for $u = f(x, t)$, we have

$$\tilde{x} = \frac{x}{1-4st}, \quad \tilde{t} = \frac{t}{1-4st},$$

$$\tilde{u} \equiv \tilde{f}(\tilde{x}, \tilde{t}) = f(x, t) \sqrt{1-4st} \exp\left[\frac{-sx^2}{1-4st}\right].$$

Next solve the first two equations above for x and t in terms of \tilde{x} and \tilde{t} :

$$x = \frac{\tilde{x}}{1+4s\tilde{t}}, \quad t = \frac{\tilde{t}}{1+4s\tilde{t}}.$$

Finally, substitute in the last equation to get

$$\tilde{f}(\tilde{x}, \tilde{t}) = f\left(\frac{\tilde{x}}{1+4s\tilde{t}}, \frac{\tilde{t}}{1+4s\tilde{t}}\right) \sqrt{\frac{1}{1+4s\tilde{t}}} \exp\left[\frac{-s\tilde{x}^2}{1+4s\tilde{t}}\right],$$

or, changing \tilde{x} to x and \tilde{t} to t ,

$$f_6(x, t) = \frac{1}{\sqrt{1+4st}} \exp\left[\frac{-sx^2}{1+4st}\right] f\left(\frac{x}{1+4st}, \frac{t}{1+4st}\right).$$

The other transformed functions can be obtained similarly. We simply list these functions:

$$\begin{aligned} f_1(x, t) &= f(x - s, t), & f_2(x, t) &= f(x, t - s), \\ f_3(x, t) &= e^s f(x, t), & f_4(x, t) &= f(e^{-s}x, e^{-2s}t), \\ f_5(x, t) &= e^{-sx + s^2 t} f(x - 2st, t), & f_\beta(x, t) &= f(x, t) + s\beta(x, t), \\ f_6(x, t) &= \frac{1}{\sqrt{1+4st}} \exp\left[\frac{-sx^2}{1+4st}\right] f\left(\frac{x}{1+4st}, \frac{t}{1+4st}\right). \end{aligned} \tag{32.28}$$

We can find the *fundamental solution* to the heat equation very simply as follows. Let $f(x, t)$ be the trivial constant solution c . Then

$$u = f_6(x, t) = \frac{c}{\sqrt{1 + 4st}} e^{-sx^2/(1+4st)}$$

is also a solution. Now choose $c = \sqrt{s/\pi}$ and translate t to $t - 1/4s$ (an allowed operation due to the invariance of the heat equation under time translation G_2). The result is

$$u = \frac{1}{\sqrt{4\pi t}} e^{-x^2/4t},$$

which is the fundamental solution of the heat equation [see (22.45)].

32.4.2 The Wave Equation

As the next example of the application of Lie groups to differential equations, we consider the wave equation in two dimensions. This equation is written as

$$u_{tt} - u_{xx} - u_{yy} = 0, \quad \text{or} \quad \eta^{ij} u_{ij} = 0 \quad \text{and} \quad \Delta = \eta^{ij} u_{ij}, \quad (32.29)$$

where $\eta = \text{diag}(1, -1, -1)$, and subscripts indicate derivatives with respect to coordinate functions $x^1 = t$, $x^2 = x$, and $x^3 = y$. With $p = 3$ and $q = 1$, a typical generator of symmetry will be of the form

$$\mathbf{v} = \sum_{i=1}^3 X^{(i)} \frac{\partial}{\partial x^i} + U \frac{\partial}{\partial u}, \quad (32.30)$$

where $\{X^{(i)}\}_{i=1}^3$ and U are functions of t, x, y , and u to be determined. The second prolongation of such a vector field is

$$\text{pr}^{(2)} \mathbf{v} = \mathbf{v} + \sum_{i=1}^3 U^{(i)}(x, u^{(2)}) \frac{\partial}{\partial u_i} + \sum_{i,j=1}^3 U^{(ij)}(x, u^{(2)}) \frac{\partial}{\partial u_{ij}},$$

where by Theorem 32.3.5,

$$\begin{aligned} U^{(i)} &= D_i \left(U - \sum_{k=1}^3 X^{(k)} u_k \right) + \sum_{k=1}^3 X^{(k)} u_{ik} = D_i U - \sum_{k=1}^3 (D_i X^{(k)}) u_k, \\ U^{(ij)} &= D_i D_j \left(U - \sum_{k=1}^3 X^{(k)} u_k \right) + \sum_{k=1}^3 X^{(k)} u_{ijk} \\ &= D_i D_j U - \sum_{k=1}^3 [(D_i D_j X^{(k)}) u_k + u_{ik} (D_j X^{(k)}) + u_{jk} (D_i X^{(k)})], \end{aligned}$$

and we have used Eq. (32.21). Using (32.21) further, the reader may show that

$$\begin{aligned}
 U^{(ij)} &= U_{ij} + u_k(\delta_{jk}U_{iu} + \delta_{ik}U_{ju} - X_{ij}^{(k)}) \\
 &\quad + u_l u_k(\delta_{il}\delta_{jk}U_{uu} - X_{iu}^{(k)}\delta_{jl} - X_{ju}^{(k)}\delta_{il}) \\
 &\quad + u_{kl}(\delta_{il}\delta_{jk}U_u - X_i^{(k)}\delta_{jl} - X_j^{(k)}\delta_{il}) \\
 &\quad - u_k u_{lm}(X_u^{(k)}\delta_{il}\delta_{jm} + X_u^{(m)}\delta_{il}\delta_{jk} + X_u^{(m)}\delta_{ik}\delta_{jl}) - u_i u_j u_k X_{uu}^{(k)},
 \end{aligned}
 \tag{32.31}$$

where a sum over repeated indices is understood.

Applying $\text{pr}^{(2)}\mathbf{v}$ to Δ , we obtain the infinitesimal criterion

$$U^{(tt)} = U^{(xx)} + U^{(yy)} \quad \text{or} \quad \eta^{ij}U^{(ij)} = 0.$$

Multiplying Eq. (32.31) by η^{ij} and setting the result equal to zero yields

$$\begin{aligned}
 0 &= \eta^{ij}U^{(ij)} \\
 &= \eta^{ij}U_{ij} + u_k(2\eta^{ik}U_{iu} - \eta^{ij}X_{ij}^{(k)}) + u_l u_k(\eta^{kl}U_{uu} - 2X_{iu}^{(k)}\eta^{il}) \\
 &\quad - 2u_{kl}X_i^{(k)}\eta^{il} - 2u_k u_{lm}X_u^{(m)}\eta^{kl} - u_i u_j u_k X_{uu}^{(k)}\eta^{ij},
 \end{aligned}
 \tag{32.32}$$

where we have used the wave equation, $\eta^{kl}u_{kl} = 0$. Equation (32.32) must hold for all derivatives of u and powers thereof (treated as independent) modulo the wave equation. Therefore, the coefficients of such “monomials” must vanish. For example, since all the terms involving $u_k u_{lm}$ are independent (even after substituting $u_{xx} + u_{yy}$ for u_{tt}), we have to conclude that $X_u^{(m)} = 0$ for all m , i.e., that $X^{(i)}$ are independent of u . Setting the coefficient of $u_k u_l$ equal to zero and noting that $X_{iu}^{(k)} = \partial X_u^{(k)} / \partial x^i = 0$ yields

$$U_{uu} = 0 \quad \Rightarrow \quad U(x, y, t, u) = \alpha(x, y, t)u + \beta(x, y, t). \tag{32.33}$$

Let us concentrate on the functions $X^{(i)}$. These are related via the term linear in u_{kl} . After inserting the wave equation in this term, we get

$$\begin{aligned}
 u_{kl}X_i^{(k)}\eta^{il} &= u_{12}(X_1^{(2)} - X_2^{(1)}) + u_{13}(X_1^{(3)} - X_3^{(1)}) - u_{23}(X_2^{(3)} + X_3^{(2)}) \\
 &\quad + u_{22}(X_1^{(1)} - X_2^{(2)}) + u_{33}(X_1^{(1)} - X_3^{(3)}).
 \end{aligned}$$

The u_{ij} in this equation are all independent; so, we can set their coefficients equal to zero:

$$\begin{aligned}
 X_1^{(2)} &= X_2^{(1)}, & X_1^{(3)} &= X_3^{(1)}, & X_2^{(3)} + X_3^{(2)} &= 0, \\
 X_1^{(1)} &= X_2^{(2)} = X_3^{(3)}.
 \end{aligned}
 \tag{32.34}$$

The reader may verify that these relations imply that $X_{jkl}^{(i)} = 0$ for any i, j, k , and l . For example,

Table 32.3 The generators of the conformal group for \mathbb{R}^3 , part of the symmetry group of the wave equation in two dimensions

| Infinitesimal generator | Transformation |
|--|----------------|
| $\mathbf{v}_1 = \partial_t, \mathbf{v}_2 = \partial_x, \mathbf{v}_3 = \partial_y$ | Translation |
| $\mathbf{v}_4 = x\partial_t + t\partial_x, \mathbf{v}_6 = -y\partial_x + x\partial_y, \mathbf{v}_7 = y\partial_t + t\partial_y$ | Rotation/Boost |
| $\mathbf{v}_5 = t\partial_t + x\partial_x + y\partial_y$ | Dilatation |
| $\mathbf{v}_8 = (t^2 + x^2 + y^2)\partial_t + 2xt\partial_x + 2yt\partial_y - tu\partial_u,$ $\mathbf{v}_9 = 2xt\partial_t + (t^2 + x^2 - y^2)\partial_x + 2xy\partial_y - xu\partial_u,$ $\mathbf{v}_{10} = 2yt\partial_t + 2xy\partial_x + (t^2 - x^2 + y^2)\partial_y - yu\partial_u$ | Inversions |

$$\begin{aligned}
 X_{222}^{(2)} &= X_{122}^{(1)} = \underbrace{X_{322}^{(3)}}_{\equiv X_{223}^{(3)}} = -\underbrace{X_{323}^{(2)}}_{\equiv X_{233}^{(2)}} = -\underbrace{X_{133}^{(1)}}_{\equiv X_{313}^{(1)}} = -\underbrace{X_{113}^{(3)}}_{\equiv X_{311}^{(3)}} \\
 &= -\underbrace{X_{211}^{(2)}}_{\equiv X_{121}^{(2)}} = -\underbrace{X_{221}^{(1)}}_{\equiv X_{122}^{(1)}} = -X_{222}^{(2)}.
 \end{aligned}
 \tag{32.35}$$

So, the first link of this chain is equal to its negative. Therefore, all the third derivatives in the chain of Eq. (32.35) vanish. It follows that all $X^{(i)}$'s are mixed polynomials of at most degree two. Writing the most general such polynomials for the three functions $X^{(1)}$, $X^{(2)}$, and $X^{(3)}$ and having them satisfy Eq. (32.34) yields

$$\begin{aligned}
 X^{(1)} &= a_1 + a_4x + a_7y + a_5t + a_8(x^2 + y^2 + t^2) + 2a_9xt + 2a_{10}yt, \\
 X^{(2)} &= a_2 + a_5x - a_6y + a_4t + a_9(x^2 - y^2 + t^2) + 2a_{10}xy + 2a_8xt, \\
 X^{(3)} &= a_3 + a_6x + a_5y + a_7t + a_{10}(-x^2 + y^2 + t^2) + 2a_9xy + 2a_8yt.
 \end{aligned}
 \tag{32.36}$$

Setting the coefficient of u_k and $\eta^{ij}U_{ij}$ equal to zero and using Eq. (32.33) gives

$$\begin{aligned}
 2\alpha_x &= X_{xx}^{(2)} + X_{yy}^{(2)} - X_{tt}^{(2)}, & 2\alpha_y &= X_{xx}^{(3)} + X_{yy}^{(3)} - X_{tt}^{(2)}, \\
 2\alpha_t &= X_{tt}^{(1)} - X_{xx}^{(1)} - X_{yy}^{(1)}, & \beta_{tt} - \beta_{xx} - \beta_{yy} &= 0.
 \end{aligned}$$

It follows that β is any solution of the wave equation, and

$$\alpha(x, y, t) = a_{11} - a_8t - a_9x - a_{10}y.$$

By inserting the expressions found for $X^{(i)}$ and U in (32.30) and writing the result in the form $\sum_i a_i \mathbf{v}_i$, we discover that the generators of the symmetry group consist of the ten vector fields given in Table 32.3 as well as the vector fields

$$u\partial_u, \quad \mathbf{v}_\beta = \beta(x, y, t)\partial_u$$

for β an arbitrary solution of the wave equation. The ten vector fields of Table 32.3 comprise the generators of the conformal group in three dimensions whose generalization to m dimensions will be studied in Sect. 37.2.

32.5 Application to ODEs

The theory of Lie groups finds one of its most rewarding applications in the integration of ODEs. Lie's fundamental observation was that if one could come up with a sufficiently large group of symmetries of a system of ODEs, then one could integrate the system. In this section we outline the general technique of solving ODEs once we know their symmetries. The following proposition will be useful (see [Warn 83, p. 40]):

Proposition 32.5.1 *Let M be an n -dimensional manifold and $\mathbf{v} \in \mathfrak{X}(M)$. Assume that $\mathbf{v}|_P \neq 0$ for some $P \in M$. Then there exists a local chart, i.e., local set of coordinate functions, (w^1, \dots, w^n) at P such that $\mathbf{v} = \partial/\partial w^1$.*

32.5.1 First-Order ODEs

The most general first-order ODE can be written as

$$\frac{du}{dx} = F(x, u) \quad \Rightarrow \quad \Delta(x, u, u_x) \equiv u_x - F(x, u) = 0. \quad (32.37)$$

A typical infinitesimal generator of the symmetry group of this equation is⁵ $\mathbf{v} = X\partial_x + U\partial_u$, whose prolongation is

$$\begin{aligned} \text{pr}^{(1)}\mathbf{v} &= \mathbf{v} + U^{(x)} \frac{\partial}{\partial u_x}, \quad \text{where} \\ U^{(x)} &\equiv U_x + (U_u - X_x)u_x - X_u u_x^2, \end{aligned} \quad (32.38)$$

as the reader may verify. The infinitesimal criterion for the one-parameter group of transformations G to be a symmetry group of Eq. (32.37) is $\text{pr}^{(1)}\mathbf{v}(\Delta) = 0$, or

$$\frac{\partial U}{\partial x} + \left(\frac{\partial U}{\partial u} - \frac{\partial X}{\partial x} \right) F - \frac{\partial X}{\partial u} F^2 = X \frac{\partial F}{\partial x} + U \frac{\partial F}{\partial u}. \quad (32.39)$$

Any solution (X, U) of this equation generates a 1-parameter group of transformations. The problem is that a *systematic* procedure for solving (32.39) is *more difficult* than solving the original equation. However, in most cases, one can *guess* a symmetry transformation (based on physical, or other, grounds), and that makes Lie's method worthwhile.

Suppose we have found a symmetry group G with infinitesimal generator \mathbf{v} that does not vanish at $P \in M \subset X \times U$. Based on Proposition 32.5.1, we can introduce new coordinates

$$w = \xi(x, u), \quad y = \eta(x, u) \quad (32.40)$$

⁵The reader is warned against the unfortunate coincidence of notation: X and U represent *both* the components of the infinitesimal generator and the spaces of independent and dependent variables!

in a neighborhood of P such that $\mathbf{v} = \partial/\partial w$, whose prolongation is also $\partial/\partial w$ [see (32.38)]. This transforms the DE of (32.37) into⁶ $\tilde{\Delta}(y, w, w_y) = 0$, and the infinitesimal criterion into

$$\text{pr}^{(1)}\mathbf{v}(\tilde{\Delta}) = \frac{\partial \tilde{\Delta}}{\partial w} = 0.$$

It follows that $\tilde{\Delta}$ is independent of w . The transformed DE is therefore $\tilde{\Delta}(y, w_y) = 0$, whose normal form, obtained by implicitly solving for dw/dy , is

$$\frac{dw}{dy} = H(y) \Rightarrow w = \int_a^y H(t) dt - w(a)$$

for some function H of y alone and some convenient point $y = a$. Substituting this expression of w as a function of y in Eq. (32.40) and eliminating y between the two equations yields u as a function of x .

Thus our task is to find the change of variables (32.40). For this, we use $\mathbf{v}(w) = 1$ and $\mathbf{v}(y) = 0$, and express them in terms of x and u :

$$\begin{aligned} \mathbf{v}(w) = \mathbf{v}(\xi) &= X \frac{\partial \xi}{\partial x} + U \frac{\partial \xi}{\partial u} = 1, \\ \mathbf{v}(y) = \mathbf{v}(\eta) &= X \frac{\partial \eta}{\partial x} + U \frac{\partial \eta}{\partial u} = 0. \end{aligned} \tag{32.41}$$

The second equation says that η is an invariant of the group generated by \mathbf{v} . We therefore use the associated characteristic ODE [see (32.3) and (32.5)] to find y (or η):

$$\frac{dx}{X(x, u)} = \frac{du}{U(x, u)}. \tag{32.42}$$

To find w (or ξ), we introduce $\chi(x, u, v) = v - \xi(x, u)$ and note that an equivalent relation containing the same information as the first equation in (32.41) is

$$X \frac{\partial \chi}{\partial x} + U \frac{\partial \chi}{\partial u} + \frac{\partial \chi}{\partial v} = 0,$$

which has the characteristic ODE

$$\frac{dx}{X(x, u)} = \frac{du}{U(x, u)} = \frac{dv}{1}, \tag{32.43}$$

for which we seek a solution of the form $v - \xi(x, u) = c$ to read off $\xi(x, u)$.

The reader may wonder whether it is sane to go through so much trouble only to replace the original single ODE with *two* ODEs such as (32.42) and (32.43)! The answer is that *in practice*, the latter two DEs are much easier to solve than the original ODE.

⁶Here we are choosing w to be the dependent variable. This choice is a freedom that is always available to us.

Example 32.5.2 The homogeneous FODE $du/dx = F(u/x)$ is invariant under the scaling transformation $(x, u) \mapsto (sx, su)$ whose infinitesimal generator is $\mathbf{v} = x\partial_x + u\partial_u$. The first prolongation of this vector is the same as the vector itself (reader, verify!).

To find the new coordinates w and y , first use Eq. (32.42) with $X(x, u) = x$ and $U(x, u) = u$:

$$\frac{dx}{x} = \frac{du}{u} \Rightarrow \frac{u}{x} = c_1 \Rightarrow y = \frac{u}{x} \quad (\text{see Box 32.1.8}).$$

Next, we note that (32.43) yields

$$\frac{dx}{x} = \frac{du}{u} = dv \Rightarrow \ln u = v + \ln c_2 \Rightarrow v = \ln(u/c_2).$$

Substituting from the previous equation, we obtain

$$v = \ln(c_1x/c_2) = \ln x + \underbrace{\ln(c_1/c_2)}_{\equiv c} \Rightarrow v - \ln x = c \Rightarrow w = \ln x.$$

The chain rule gives $du/dx = (1 + yw_y)/w_y$, so that the DE becomes

$$\frac{1 + yw_y}{w_y} = F(y) \Rightarrow \frac{dw}{dy} = \frac{1}{F(y) - y},$$

which can be integrated to give $w = H(y)$ or $\ln x = H(y) = H(u/x)$, which defines u as an implicit function of x .

32.5.2 Higher-Order ODEs

The same argument used in the first order ODEs can be used for higher-order ODEs to reduce their orders.

Proposition 32.5.3 *Let*

$$\Delta(x, u^{(n)}) = \Delta(x, u, u_1, \dots, u_n) = 0, \quad u_k \equiv \frac{d^k u}{dx^k},$$

be an n th order ODE. If this ODE has a one-parameter symmetry group, then there exist variables $w = \xi(x, u)$ and $y = \eta(x, u)$ such that

$$\Delta(x, u^{(n)}) = \tilde{\Delta}\left(y, \frac{dw}{dy}, \dots, \frac{d^n w}{dy^n}\right) = 0,$$

i.e., in terms of w and y , the ODE becomes of $(n - 1)$ st order in w_y .

Proof The proof is exactly the same as in the first-order case. The only difference is that one has to consider $\text{pr}^{(n)}\mathbf{v}$, where $\mathbf{v} = \partial/\partial w$. But Problem 32.7 shows that $\text{pr}^{(n)}\mathbf{v} = \mathbf{v}$, as in the first-order case. \square

Example 32.5.4 Consider a second-order DE $\Delta(u, u_x, u_{xx}) = 0$, which does not depend on x explicitly. The fact that $\partial\Delta/\partial x = 0$ suggests $w = x$. So, we switch the dependent and independent variables and write $w = x$, and $y = u$. Then, using the chain rule, we get

$$\frac{du}{dx} = \frac{1}{w_y}, \quad \frac{d^2u}{dx^2} = -\frac{w_{yy}}{w_y^3}.$$

Substituting in the original DE, we obtain

$$\tilde{\Delta}(y, w_y, w_{yy}) \equiv \Delta\left(y, \frac{1}{w_y}, -\frac{w_{yy}}{w_y^3}\right) = 0,$$

which is of first order in w_y .

Example 32.5.5 The order of the SOLDE $u_{xx} + p(x)u_x + q(x)u = 0$ can be reduced by noting that the DE is invariant under the scaling transformation $(x, u) \mapsto (x, su)$, whose infinitesimal generator is $\mathbf{v} = u\partial_u$. With this vector field, Eqs. (32.42) and (32.43) give

$$\frac{dx}{0} = \frac{du}{u}, \quad \frac{dx}{0} = \frac{du}{u} = dv.$$

For the first equation to make sense, we have to have

$$dx = 0 \Rightarrow x = c_1 \Rightarrow y = x \quad (\text{by Box 32.1.8}).$$

The second equation in u gives

$$v = \ln u + c \Rightarrow v - \ln u = c \Rightarrow w = \ln u \Rightarrow u = e^w.$$

Using the chain rule, we obtain

$$u_x = \frac{dw}{dx}e^w = \frac{dw}{dy}e^w \quad \text{and} \quad u_{xx} = (w_{yy} + w_y^2)e^w.$$

Riccati equation By inserting this in the original DE and writing $z = w_y$, we obtain

$$\frac{dz}{dy} = -z^2 - p(y)z - q(y),$$

which is the well-known first-order **Riccati equation**.

32.5.3 DEs with Multiparameter Symmetries

We have seen that 1-parameter symmetries reduce the order of an ODE by 1. It is natural to suspect that an r -parameter symmetry will reduce the order by r . Although this suspicion is correct, it turns out that in general, one cannot reconstruct the solution of the original equation from those of the

reduced $(n - r)$ th-order equation. (See [Olve 86, pp. 148–158] for a thorough discussion of this problem.) However, the special, but important, case of second-order DEs is an exception. The deep reason behind this is the exceptional structure of 2-dimensional Lie algebras given in Box 29.2.5. We cannot afford to go into details of the reasoning, but simply quote the following important theorem.

Theorem 32.5.6 *Let $\Delta(x, u^{(n)}) = 0$ be an n th-order ODE invariant under a 2-parameter group. Then there is an $(n - 2)$ nd-order ODE $\tilde{\Delta}(y, w^{(n-2)}) = 0$ with the property that the general solution to Δ can be found by integrating the general solution to $\tilde{\Delta}$. In particular, a second-order ODE having a 2-parameter group of symmetries can be solved by integration.*

Let us analyze the case of a second-order ODE in some detail. By Box 29.2.5, the infinitesimal generators \mathbf{v}_1 and \mathbf{v}_2 satisfy the Lie bracket relation

$$[\mathbf{v}_1, \mathbf{v}_2] = c\mathbf{v}_1, \quad c = 0 \quad \text{or} \quad 1.$$

We shall treat the abelian case ($c = 0$) and leave the nonabelian case for the reader. To begin with, we use s and t for the transformed variables, and at the end replace them with y and w .

By Proposition 32.5.1, we can let $\mathbf{v}_1 = \partial/\partial s$. Then \mathbf{v}_2 can be expressed as the linear combination

$$\mathbf{v}_2 = \alpha(s, t) \frac{\partial}{\partial s} + \beta(s, t) \frac{\partial}{\partial t}.$$

The commutation relation $[\mathbf{v}_1, \mathbf{v}_2] = 0$ gives

$$0 = [\partial_s, \alpha \partial_s + \beta \partial_t] = \frac{\partial \alpha}{\partial s} \partial_t + \frac{\partial \beta}{\partial s} \partial_s,$$

showing that α and β are independent of s . We want to simplify \mathbf{v}_2 as much as possible without changing \mathbf{v}_1 . A transformation that accomplishes this is $S = s + h(t)$ and $T = T(t)$. Then, by Eq. (28.8) we obtain

$$\begin{aligned} \mathbf{v}_1 &= \mathbf{v}_1(S) \frac{\partial}{\partial S} + \mathbf{v}_1(T) \frac{\partial}{\partial T} = \frac{\partial S}{\partial s} \frac{\partial}{\partial S} + \frac{\partial T}{\partial s} \frac{\partial}{\partial T} = \frac{\partial}{\partial S}, \\ \mathbf{v}_2 &= \mathbf{v}_2(S) \frac{\partial}{\partial S} + \mathbf{v}_2(T) \frac{\partial}{\partial T} = \left(\alpha \frac{\partial S}{\partial s} + \beta \frac{\partial S}{\partial t} \right) \frac{\partial}{\partial S} + \left(\alpha \frac{\partial T}{\partial s} + \beta \frac{\partial T}{\partial t} \right) \frac{\partial}{\partial T} \\ &= (\alpha + \beta h') \frac{\partial}{\partial S} + \beta T' \frac{\partial}{\partial T}. \end{aligned}$$

If $\beta \neq 0$, we choose $T' = 1/\beta$ and $h' = -\alpha/\beta$ to obtain

$$\mathbf{v}_1 = \frac{\partial}{\partial S}, \quad \mathbf{v}_2 = \frac{\partial}{\partial T}, \quad (32.44)$$

where we have substituted s for S and t for T . If $\beta = 0$, we choose $\alpha = T$, and change the notation from S to s and T to t to obtain

$$\mathbf{v}_1 = \frac{\partial}{\partial s}, \quad \mathbf{v}_2 = t \frac{\partial}{\partial s}. \quad (32.45)$$

The next step is to decide which coordinate is the independent variable, prolong the vector fields, and apply it to the DE to find the infinitesimal criterion. For $\beta \neq 0$, the choice is immaterial. So, let $w = s$ and $y = t$. Then the prolongation of \mathbf{v}_1 and \mathbf{v}_2 will be the same as the vectors themselves, and with $\Delta(y, w, w_y, w_{yy}) \equiv w_{yy} - F(y, w, w_y)$, the infinitesimal criteria for invariance will be

$$\begin{aligned} 0 &= \text{pr}^{(2)}\mathbf{v}_1(\Delta) = \mathbf{v}_1(\Delta) = \frac{\partial \Delta}{\partial w} = -\frac{\partial F}{\partial w}, \\ 0 &= \text{pr}^{(2)}\mathbf{v}_2(\Delta) = \mathbf{v}_2(\Delta) = \frac{\partial \Delta}{\partial y} = -\frac{\partial F}{\partial y}. \end{aligned}$$

It follows that in the (y, w) system, F will be a function of w_y alone and the DE will be of the form

$$w_{yy} = F(w_y) \Rightarrow \frac{dw_y}{dy} = F(w_y) \Rightarrow \underbrace{\int^{w_y} \frac{dz}{F(z)}}_{\equiv H(w_y)}.$$

The last equation can be solved for w_y in terms of y and the result integrated.

For $\beta = 0$, choose $w = t$ and $y = s$. Then \mathbf{v}_1 will not prolongate, and as the reader may verify,

$$\text{pr}^{(2)}\mathbf{v}_2 = \mathbf{v}_2 - w_y^2 \frac{\partial}{\partial w_y} - 3w_y w_{yy} \frac{\partial}{\partial w_{yy}} = w \frac{\partial}{\partial y} - w_y^2 \frac{\partial}{\partial w_y} - 3w_y w_{yy} \frac{\partial}{\partial w_{yy}},$$

and the infinitesimal criteria for invariance will be

$$\begin{aligned} 0 &= \text{pr}^{(2)}\mathbf{v}_1(\Delta) = \mathbf{v}_1(\Delta) = \frac{\partial \Delta}{\partial y} = -\frac{\partial F}{\partial y}, \\ 0 &= \text{pr}^{(2)}\mathbf{v}_2(\Delta) = -w \underbrace{\frac{\partial F}{\partial y}}_{=0} + w_y^2 \frac{\partial F}{\partial w_y} + 3w_y \underbrace{w_{yy}}_{=F}. \end{aligned}$$

It follows that in the (y, w) system, F will be a function of w and w_y and satisfy the DE

$$w_y \frac{\partial F}{\partial w_y} = 3F,$$

whose solution is of the form $F(w, w_y) = w_y^3 \tilde{F}(w)$. The original DE now becomes

$$w_{yy} = w_y^3 \tilde{F}(w),$$

for which we use the chain rule $w_{yy} = w_y \partial w_y / \partial w$ to obtain

$$\frac{dw_y}{dw} = w_y^2 \tilde{F}(w) \Rightarrow -\frac{1}{w_y} = \underbrace{\int^w \tilde{F}(z) dz}_{\equiv H(w)} \Rightarrow \frac{dw}{dy} = -\frac{1}{H(w)},$$

which can be integrated. Had we chosen $w = s$ and $y = t$, F would have been a function of y and the DE would have reduced to $w_{yy} = F(y)$, which could be solved by two consecutive integrations. The nonabelian 2-dimensional Lie algebra can be analyzed similarly. The reader may verify that if $\beta = 0$, the vector fields can be chosen to be

$$\mathbf{v}_1 = \frac{\partial}{\partial s}, \quad \mathbf{v}_2 = s \frac{\partial}{\partial s}, \quad (32.46)$$

leading to the ODE $w_{yy} = w_y \tilde{F}(y)$, and if $\beta \neq 0$, the vector fields can be chosen to be

$$\mathbf{v}_1 = \frac{\partial}{\partial s}, \quad \mathbf{v}_2 = s \frac{\partial}{\partial s} + t \frac{\partial}{\partial t}, \quad (32.47)$$

leading to the ODE $w_{yy} = \tilde{F}(w_y)/y$. Both of these ODEs are integrable as in the abelian case.

32.6 Problems

32.1 Suppose that $\{F_i\}_{i=1}^n$ are invariants of the PDE (32.3). Show that any function $f(F_1, F_2, \dots, F_n)$ is also an invariant of the PDE.

32.2 Find the function $\tilde{f} = \theta \cdot f$ when $f(x) = ax + b$ and θ is the angle of rotation of $SO(2)$.

32.3 Use the result of Problem 32.2 to find \tilde{u}_1 . Hint: Note that $a = u_1$.

32.4 Transform the DE of Example 32.3.2 from Cartesian to polar coordinates to obtain $dr/d\theta = r^3$.

32.5 Using the definition of total derivative, verify Eq. (32.21).

32.6 Show that $SO(2)$ is a symmetry group of the first-order DE

$$\Delta(x, u, u_1) = (u - x)u_1 + x + u = 0$$

and write the same DE in polar coordinates.

32.7 Show that the n th prolongation of the generator of the i th translation, ∂_i , is the same as the original vector.

32.8 Find the first prolongation of the generator of scaling: $x\partial_x + u\partial_u$.

32.9 Show that when the group acts only on the single dependent variable u , the prolongation of $\mathbf{v} = U\partial_u$ is given by

$$\text{pr}^{(1)}\mathbf{v} = \mathbf{v} + \sum_{j=1}^p U_j \frac{\partial}{\partial u_j}, \quad \text{where} \quad U_j = \frac{\partial U}{\partial x^j} + u_j \frac{\partial U}{\partial u}.$$

32.10 Show that the n th prolongation of $\mathbf{v} = X(x, u)\partial_x + U(x, u)\partial_u$ for an ordinary DE of n th order is

$$\text{pr}^{(n)}\mathbf{v} = \mathbf{v} + \sum_{k=1}^n U^{[k]} \frac{\partial}{\partial u^{(k)}},$$

where

$$u^{(k)} \equiv \frac{\partial^k u}{\partial x^k} \quad \text{and} \quad U^{[k]} = D_x^k(U - Xu_x) + Xu^{(k+1)}.$$

32.11 Compute the second prolongation of the infinitesimal generators of the symmetry group of the heat equation.

32.12 Derive Eqs. (32.31) and (32.32).

32.13 Using Eq. (32.34) show that $X_{jkl}^{(i)} = 0$ for any i, j, k , and l .

32.14 The **Korteweg-de Vries equation** is $u_t + u_{xxx} + uu_x = 0$. Using the technique employed in computing the symmetries of the heat and wave equations, show that the infinitesimal generators of symmetries of the Korteweg-de Vries equation are

$$\begin{aligned} \mathbf{v}_1 &= \partial_x, & \mathbf{v}_2 &= \partial_t, & \text{translation} \\ \mathbf{v}_3 &= t\partial_x + \partial_u, & & & \text{Galilean boost} \\ \mathbf{v}_4 &= x\partial_x + 3t\partial_t - 2u\partial_u. & & & \text{scaling} \end{aligned}$$

32.15 Suppose $M(x, u)dx + N(x, u)du = 0$ has a 1-parameter symmetry group with generator $\mathbf{v} = X\partial_x + U\partial_u$. Show that the function $q(x, u) = 1/(XM + UN)$ is an integrating factor.

32.16 Show that the second prolongation of $\mathbf{v} = w\partial_y$ (with y treated as independent variable) is

$$\text{pr}^{(2)}\mathbf{v} = \mathbf{v} - w_y^2 \frac{\partial}{\partial w_y} - 3w_y w_{yy} \frac{\partial}{\partial w_{yy}}.$$

32.17 Go through the case of $\beta = 0$ in the solution of the second order ODE and, choosing $w = s$ and $y = t$, show that F will be a function of y alone and the original DE will reduce to $w_{yy} = F(y)$.

32.18 Show that in the case of the nonabelian 2-dimensional Lie algebra,

- (a) the vector fields can be chosen to be

$$\mathbf{v}_1 = \frac{\partial}{\partial s}, \quad \mathbf{v}_2 = s \frac{\partial}{\partial s}$$

if $\beta = 0$.

- (b) Show that these vector fields lead to the ODE $w_{yy} = w_y \tilde{F}(y)$.
(c) If $\beta \neq 0$, show that the vector fields can be chosen to be

$$\mathbf{v}_1 = \frac{\partial}{\partial s}, \quad \mathbf{v}_2 = s \frac{\partial}{\partial s} + t \frac{\partial}{\partial t}$$

- (d) Finally, show that the latter vector fields lead to the ODE $w_{yy} = \tilde{F}(w_y)/y$.

In this chapter we shall start with one of the oldest and most useful branches of mathematical physics, the calculus of variations. After giving the fundamentals and some examples, we shall investigate the consequences of symmetries associated with variational problems. The chapter then ends with Noether's theorem, which connects such symmetries with their associated conservation laws. All vector spaces of relevance in this chapter will be assumed to be real.

33.1 The Calculus of Variations

One of the main themes of calculus is the extremal problem: Given a function $f : \mathbb{R} \supset D \rightarrow \mathbb{R}$, find the points in the domain D of f at which f attains a maximum or minimum. To locate such points, we find the zeros of the derivative of f . For multivariable functions, $f : \mathbb{R}^p \supset \Omega \rightarrow \mathbb{R}$, the notion of *gradient* generalizes that of the derivative. To find the j th component of the gradient ∇f , we calculate the difference Δf between the value of f at $(x^1, \dots, x^j + \varepsilon, \dots, x^p)$ and its value at $(x^1, \dots, x^j, \dots, x^p)$, divide this difference by ε , and take the limit $\varepsilon \rightarrow 0$. This is simply partial differentiation, and the j th component of the gradient is just the j th partial derivative of f .

33.1.1 Derivative for Hilbert Spaces

To make contact with the subject of this chapter, let us reinterpret the notion of differentiation. The most useful interpretation is geometric. In fact, our first encounter with the derivative is geometrical: We are introduced to the concept through lines tangent to curves. In this language, the derivative of a function $f : \mathbb{R} \supset \Omega \rightarrow \mathbb{R}$ at x_0 is a line (or function) $\psi : \Omega \supset \Omega_0 \rightarrow \mathbb{R}$ passing through $(x_0, f(x_0))$ whose slope is defined to be the derivative of f at x_0 (see Fig. 33.1):

$$\psi(x) = f(x_0) + f'(x_0)(x - x_0).$$

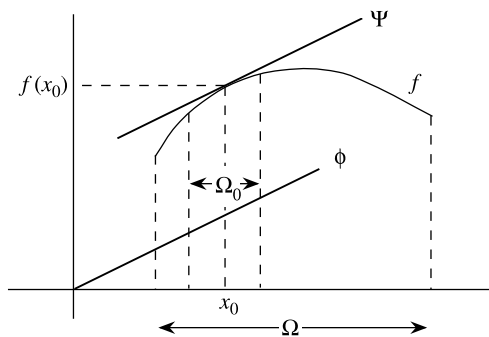

Fig. 33.1 The derivative at $(x_0, f(x_0))$ as a *linear function* passing through the origin with a slope $f'(x_0)$. The function f is assumed to be defined on a subset Ω of the real line. Ω_0 restricts the x 's to be close to x_0 to prevent the function from misbehaving (blowing up), and to make sure that the limit in the definition of derivative makes sense

The function $\psi(x)$ describes a line, but it is not a *linear function* (in the vector-space sense of the word). The requirement of linearity is due to our desire for generalization of differentiation to Hilbert spaces, on which linear maps are the most natural objects. Therefore, we consider the line parallel to $\psi(x)$ that passes through the origin. Call this $\phi(x)$. Then

$$\phi(x) = f'(x_0)x, \quad (33.1)$$

which is indeed a linear function. We identify $\phi(x)$ as the derivative of f at x_0 . This identification may appear strange at first but, as we shall see shortly, is the most convenient and useful. Of course, any identification requires a one-to-one correspondence between objects identified. It is clear that indeed there is a one-to-one correspondence between derivatives at points and linear functions with appropriate slopes.

Equation (33.1) can be used to geometrize the definition of derivative. First consider

$$f'(x_0) = \frac{\phi(x) - \phi(x_0)}{x - x_0}, \quad \text{and} \quad f'(x_0) = \lim_{x \rightarrow x_0} \frac{f(x) - f(x_0)}{x - x_0}.$$

Next note that, contrary to f which is usually defined only for a subset of the real line, ϕ is defined for all real numbers \mathbb{R} , and that $\phi(x - x_0) = \phi(x) - \phi(x_0)$ due to the linearity of ϕ . Thus, we have

$$\lim_{x \rightarrow x_0} \frac{f(x) - f(x_0)}{x - x_0} = \frac{\phi(x) - \phi(x_0)}{x - x_0} = \lim_{x \rightarrow x_0} \frac{\phi(x - x_0)}{x - x_0},$$

or

$$\lim_{x \rightarrow x_0} \frac{|f(x) - f(x_0) - \phi(x - x_0)|}{|x - x_0|} = 0 \quad (33.2)$$

where we have introduced absolute values in anticipation of its analogue—norm. Equation (33.2) is readily generalized to any complete normed vector space (Banach space), and in particular to any Hilbert space:

Definition 33.1.1 Let \mathcal{H}_1 and \mathcal{H}_2 be Hilbert spaces with norms $\|\cdot\|_1$ and $\|\cdot\|_2$, respectively. Let $f : \mathcal{H}_1 \supset \Omega \rightarrow \mathcal{H}_2$ be any map and $|x_0\rangle \in \Omega$. Suppose there is a linear map $\mathbf{T} \in \mathcal{L}(\mathcal{H}_1, \mathcal{H}_2)$ with the property that

$$\lim_{\|x-x_0\|_1 \rightarrow 0} \frac{\|f(|x\rangle) - f(|x_0\rangle) - \mathbf{T}(|x\rangle - |x_0\rangle)\|_2}{\|x-x_0\|_1} = 0 \quad \text{for } |x\rangle \in \Omega.$$

Then, we say that f is **differentiable at $|x_0\rangle$** , and we define the **derivative of f at $|x_0\rangle$** to be $\mathbf{D}f(x_0) \equiv \mathbf{T}$. If f is differentiable at each $|x\rangle \in \Omega$, the map

differentiability of a function on a Hilbert space at a point

$$\mathbf{D}f : \Omega \rightarrow \mathcal{L}(\mathcal{H}_1, \mathcal{H}_2) \quad \text{given by} \quad \mathbf{D}f(|x\rangle) = \mathbf{D}f(x)$$

is called the **derivative** of f .

The reader may verify that if the derivative exists, it is unique.

Example 33.1.2 Let $\mathcal{H}_1 = \mathbb{R}^n$ and $\mathcal{H}_2 = \mathbb{R}^m$ and $f : \mathbb{R}^n \supset \Omega \rightarrow \mathbb{R}^m$. Then for $|x\rangle \in \Omega$, $\mathbf{D}f(x)$ is a linear map, which can be represented by a matrix in the standard bases of \mathbb{R}^n and \mathbb{R}^m . To find this matrix, we need to let $\mathbf{D}f(x)$ act on the j th standard basis of \mathbb{R}^n , i.e., we need to evaluate $\mathbf{D}f(x)|e_j\rangle$. This suggests taking $|y\rangle = |x\rangle + h|e_j\rangle$ (with $h \rightarrow 0$) as the vector appearing in the definition of derivative at $|x\rangle$. Then

$$\begin{aligned} & \frac{\|f(|y\rangle) - f(|x\rangle) - \mathbf{D}f(x)(|y\rangle - |x\rangle)\|_2}{\|y-x\|_1} \\ &= \frac{\|f(x^1, \dots, x^j + h, \dots, x^n) - f(x^1, \dots, x^j, \dots, x^n) - h\mathbf{D}f(x)|e_j\rangle\|_2}{|h|} \end{aligned}$$

approaches zero as $h \rightarrow 0$, so that the i th component of the ratio also goes to zero. But the i th component of $\mathbf{D}f(x)|e_j\rangle$ is simply a_j^i , the ij th component of the matrix of $\mathbf{D}f(x)$. Therefore,

$$\lim_{h \rightarrow 0} \frac{|f^i(x^1, \dots, x^j + h, \dots, x^n) - f^i(x^1, \dots, x^j, \dots, x^n) - ha_j^i|}{|h|} = 0,$$

which means that $a_j^i = \partial f^i / \partial x^j$.

The result of the example above can be stated as follows:

Box 33.1.3 For $f : \mathbb{R}^n \supset \Omega \rightarrow \mathbb{R}^m$, the matrix of $\mathbf{D}f(x)$ in the standard basis of \mathbb{R}^n and \mathbb{R}^m is the **Jacobian matrix** of f .

The case of $\mathcal{H}_2 = \mathbb{R}$ deserves special attention. Let \mathcal{H} be a Hilbert space. Then $\mathbf{D}f(x) \in \mathcal{L}(\mathcal{H}, \mathbb{R}) = \mathcal{H}^*$ is denoted by $\mathbf{d}f(x)$ and renamed the **differential** of f at $|x\rangle$. Furthermore, through the inner product, one can identify $\mathbf{d}f : \Omega \rightarrow \mathcal{H}^*$ with another map defined as follows:

differential and gradient of f at $|x\rangle$

Definition 33.1.4 Let \mathcal{H} be a Hilbert space and $f : \mathcal{H} \supset \Omega \rightarrow \mathbb{R}$. The **gradient** ∇f of f is the map $\nabla f : \Omega \rightarrow \mathcal{H}$ defined by

$$\langle \nabla f(x) | a \rangle \equiv \langle \mathbf{d}f(x), a \rangle \quad \forall |x\rangle \in \Omega, |a\rangle \in \mathcal{H}$$

where $\langle \cdot, \cdot \rangle$ is the pairing $\langle \cdot, \cdot \rangle : \mathcal{H}^* \times \mathcal{H} \rightarrow \mathbb{R}$ of \mathcal{H} and its dual.

Note that although f is not an element of \mathcal{H}^* , $\mathbf{d}f(x)$ is, for all points $|x\rangle \in \Omega$ at which the differential is defined.

Example 33.1.5 Consider the function $f : \mathcal{H} \rightarrow \mathbb{R}$ given by $f(|x\rangle) = \|x\|^2$. Since

$$\|y - x\|^2 = \|y\|^2 - \|x\|^2 - 2\langle x | y - x \rangle$$

and since the derivative is unique, the reader may check that $\mathbf{d}f(x)|a\rangle = 2\langle x | a \rangle$, or $\nabla f(|x\rangle) = 2|x\rangle$.

Derivatives could be defined in terms of directions as well:

Definition 33.1.6 Let \mathcal{H}_1 and \mathcal{H}_2 be Hilbert spaces. Let $f : \mathcal{H}_1 \supset \Omega \rightarrow \mathcal{H}_2$ be any map and $|x\rangle \in \Omega$. We say that f has a derivative in the direction $|a\rangle \in \mathcal{H}_1$ at $|x\rangle$ if

$$\left. \frac{d}{dt} f(|x\rangle + t|a\rangle) \right|_{t=0}$$

exists. We call this element of \mathcal{H}_2 the **directional derivative of f in the direction $|a\rangle \in \mathcal{H}_1$ at $|x\rangle$** .

The reader may verify that if f is differentiable at $|x\rangle$ (in the context of Definition 33.1.1), then the directional derivative of f in any direction $|a\rangle$ exists at $|x\rangle$ and is given by

$$\left. \frac{d}{dt} f(|x\rangle + t|a\rangle) \right|_{t=0} = \mathbf{D}f(x)|a\rangle. \tag{33.3}$$

33.1.2 Functional Derivative

We now specialize to the Hilbert space of square-integrable functions $\mathcal{L}^2(\Omega)$ for some open subset Ω of some \mathbb{R}^m . We need to change our notation somewhat. Let us agree to denote the elements of $\mathcal{L}^2(\Omega)$ by f, u , etc. Real-valued functions on $\mathcal{L}^2(\Omega)$ will be denoted by \mathbf{L}, \mathbf{H} , etc. The m -tuples will be denoted by boldface lowercase letters. To summarize,

$$\begin{aligned} \mathbf{x}, \mathbf{y} \in \mathbb{R}^m, \quad f, u \in \mathcal{L}^2(\Omega) &\Rightarrow f, u : \mathbb{R}^m \supset \Omega \rightarrow \mathbb{R}, \\ \langle f | u \rangle = \int_{\Omega} f(\mathbf{x})u(\mathbf{x}) d^m x, \quad \mathbf{L}, \mathbf{H} : \mathcal{L}^2(\Omega) &\rightarrow \mathbb{R}. \end{aligned}$$

Furthermore, the evaluation of \mathbf{L} at u is denoted by $\mathbf{L}[u]$.

When dealing with the space of functions, the gradient of Definition 33.1.4 is called a **functional derivative** or **variational derivative** and denoted by $\delta\mathbf{L}/\delta u$. So

functional derivative or variational derivative

$$\left\langle \frac{\delta\mathbf{L}}{\delta u} | f \right\rangle \equiv \int_{\Omega} \frac{\delta\mathbf{L}}{\delta u}(\mathbf{x}) f(\mathbf{x}) d^m x = \left. \frac{d}{dt} \mathbf{L}[u + tf] \right|_{t=0}, \quad (33.4)$$

where we have used Eq. (33.3). Note that by definition, $\delta\mathbf{L}/\delta u$ is an element of the Hilbert space $\mathcal{L}^2(\Omega)$; so, the integral of (33.4) makes sense. Equation (33.4) is frequently used to compute functional derivatives.

An immediate consequence of Eq. (33.4) is the following important result.

Proposition 33.1.7 *Let $\mathbf{L} : \mathcal{L}^2(\Omega) \rightarrow \mathbb{R}$ for some $\Omega \subset \mathbb{R}^m$. If \mathbf{L} has an extremum at u , then*

$$\frac{\delta\mathbf{L}}{\delta u} = 0.$$

Proof If \mathbf{L} has an extremum at u , then the RHS of (33.4) vanishes for any function f , in particular, for any orthonormal basis vector $|e_i\rangle$. Completeness of a basis now implies that the directional derivative must vanish (see Proposition 7.1.9). \square

Just as in the case of partial derivatives, where some simple relations such as derivative of powers and products can be used to differentiate more complicated expressions, there are some primitive formulas involving functional derivatives that are useful in computing other more complicated expressions. Consider the **evaluation function**

evaluation function

$$\mathbf{E}_y : \mathcal{L}^2(\Omega) \rightarrow \mathbb{R} \quad \text{given by} \quad \mathbf{E}_y[f] = f(\mathbf{y}).$$

Using Eq. (33.4), we can easily compute the functional derivative of \mathbf{E}_y :

$$\begin{aligned} \int_{\Omega} \frac{\delta\mathbf{E}_y[u]}{\delta u}(\mathbf{x}) f(\mathbf{x}) d^m x &= \left. \frac{d}{dt} \mathbf{E}_y[u + tf] \right|_{t=0} = \left. \frac{d}{dt} \{u(\mathbf{y}) + tf(\mathbf{y})\} \right|_{t=0} \\ &= f(\mathbf{y}) \quad \Rightarrow \quad \frac{\delta\mathbf{E}_y[u]}{\delta u}(\mathbf{x}) = \delta(\mathbf{x} - \mathbf{y}). \end{aligned} \quad (33.5)$$

It is instructive to compare (33.5) with the similar formula in multivariable calculus, where real-valued functions f take a vector \mathbf{x} and give a real number. The analogue of the evaluation function is E_i , which takes a vector \mathbf{x} and gives the real number x^i , the i th component of \mathbf{x} . Using the definition of partial derivative, one readily shows that $\partial E_i / \partial x^j = \delta_{ij}$, which is (somewhat less precisely) written as $\partial x^i / \partial x^j = \delta_{ij}$. The same sort of imprecision is used to rewrite Eq. (33.5) as

$$\frac{\delta u(\mathbf{y})}{\delta u(\mathbf{x})} \equiv \frac{\delta u_y}{\delta u_x} = \delta(\mathbf{x} - \mathbf{y}), \quad (33.6)$$

where we have turned the arguments into indices to make the analogy with the discrete case even stronger.

Another useful formula concerns *derivatives* of square-integrable functions. Let $\mathbf{E}_{\mathbf{y},i}$ denote the evaluation of the derivative of functions with respect to the i th coordinate:

$$\mathbf{E}_{\mathbf{y},i} : \mathcal{L}^2(\Omega) \rightarrow \mathbb{R} \quad \text{given by} \quad \mathbf{E}_{\mathbf{y},i}(f) = \partial_i f(\mathbf{y}).$$

Then a similar argument as above will show that

$$\frac{\delta \mathbf{E}_{\mathbf{y},i}}{\delta u}(\mathbf{x}) = -\partial_i \delta(\mathbf{x} - \mathbf{y}), \quad \text{or} \quad \frac{\delta \partial_i u(\mathbf{y})}{\delta u(\mathbf{x})} = -\partial_i \delta(\mathbf{x} - \mathbf{y}),$$

and in general,

$$\frac{\delta \partial_{i_1 \dots i_k} u(\mathbf{y})}{\delta u(\mathbf{x})} = (-1)^k \partial_{i_1 \dots i_k} \delta(\mathbf{x} - \mathbf{y}). \quad (33.7)$$

Equation (33.7) holds only if the function f , the so-called *test function*, vanishes on $\partial\Omega$, the boundary of the region of integration. If it does not, then there will be a “surface term” that will complicate matters considerably. Fortunately, in most applications this surface term is *required* to vanish. So, let us adhere to the convention that

Box 33.1.8 All test functions $f(\mathbf{x})$ appearing in the integral of Eq. (33.4) are assumed to vanish at the boundary of Ω .

For applications, we need to generalize the concept of functions on Hilbert spaces. First, it is necessary to consider maps from a Hilbert space to \mathbb{R}^n . For simplicity, we confine ourselves to the Hilbert space $\mathcal{L}^2(\Omega)$. Such a map $\mathbf{H} : \mathcal{L}^2(\Omega) \rightarrow D \subset \mathbb{R}^n$, for some subset D of \mathbb{R}^n , can be written in components

$$\mathbf{H} = (\mathbf{H}_1, \mathbf{H}_2, \dots, \mathbf{H}_n), \quad \text{where} \quad \mathbf{H}_i : \mathcal{L}^2(\Omega) \rightarrow \mathbb{R}, \quad i = 1, \dots, n.$$

Next, we consider an ordinary multivariable function $L : \mathbb{R}^n \supset D \rightarrow \mathbb{R}$, and use it to construct a new function on $\mathcal{L}^2(\Omega)$, the composite of L and \mathbf{H} :

$$L \circ \mathbf{H} : \mathcal{L}^2(\Omega) \rightarrow \mathbb{R}, \quad L \circ \mathbf{H}[u] = L(\mathbf{H}_1[u], \dots, \mathbf{H}_n[u]).$$

Then the functional derivative of $L \circ \mathbf{H}$ can be obtained using the chain rule and noting that the derivative of L is the common partial derivative. It follows that

$$\frac{\delta L \circ \mathbf{H}[u]}{\delta u}(\mathbf{x}) = \left\{ \frac{\delta}{\delta u} L(\mathbf{H}_1[u], \dots, \mathbf{H}_n[u]) \right\}(\mathbf{x}) = \sum_{i=1}^n \partial_i L \frac{\delta \mathbf{H}_i}{\delta u}(\mathbf{x}), \quad (33.8)$$

where $\partial_i L$ is the partial derivative of L with respect to its i th argument.

Example 33.1.9 Let $L : (a, b) \times \mathbb{R} \times \mathbb{R} \rightarrow \mathbb{R}$, be a function of three variables the first one of which is defined for the real interval (a, b) . Let $\mathbf{H}_i : \mathcal{L}^2(a, b) \rightarrow \mathbb{R}$, $i = 1, 2, 3$, be defined by

$$\mathbf{H}_1[u] \equiv x, \quad \mathbf{H}_2[u] = \mathbf{E}_x[u] = u(x), \quad \mathbf{H}_3[u] = \mathbf{E}'_x[u] \equiv u'(x),$$

where \mathbf{E}_x is the evaluation function and \mathbf{E}'_x evaluates the derivative. It follows that $L \circ \mathbf{H}[u] = L(x, u(x), u'(x))$. Then, noting that $\mathbf{H}_1[u]$ is independent of u , we have

$$\begin{aligned} \frac{\delta L \circ \mathbf{H}[u]}{\delta u}(y) &= \partial_1 L \frac{\delta \mathbf{H}_1[u]}{\delta u}(y) + \partial_2 L \frac{\delta \mathbf{E}_x[u]}{\delta u}(y) + \partial_3 L \frac{\delta \mathbf{E}'_x[u]}{\delta u}(y) \\ &= 0 + \partial_2 L \delta(y - x) - \partial_3 L \delta'(y - x) = \partial_2 L \delta(x - y) \\ &\quad + \partial_3 L \delta'(x - y). \end{aligned}$$

This is normally written as

$$\frac{\delta L(x, u(x), u'(x))}{\delta u}(y) = \frac{\partial L}{\partial u} \delta(x - y) + \frac{\partial L}{\partial u'} \delta'(x - y), \quad (33.9)$$

which is the unintegrated version of the classical Euler-Lagrange equation for a single particle, to which we shall return shortly.

A generalization of the example above turns L into a function on $\Omega \times \mathbb{R} \times \mathbb{R}^m$ with $\Omega \subset \mathbb{R}^m$, so that

$$L(x^1, \dots, x^m, u(\mathbf{x}), \partial_1 u(\mathbf{x}), \dots, \partial_m u(\mathbf{x})) \in \mathbb{R}, \quad \text{with } \mathbf{x} \in \mathbb{R}^m.$$

The functions $\{\mathbf{H}_i\}_{i=1}^{2m+1}$ are defined as

$$\begin{aligned} \mathbf{H}_i[u] &\equiv x^i && \text{for } i = 1, 2, \dots, m, \\ \mathbf{H}_i[u] &\equiv \mathbf{E}_x[u] = u(\mathbf{x}) && \text{for } i = m + 1, \\ \mathbf{H}_i[u] &\equiv \mathbf{E}_{x,i}[u] = \partial_i u(\mathbf{x}) && \text{for } i = m + 2, \dots, 2m + 1, \end{aligned}$$

and lead to the equation

$$\frac{\delta L \circ \mathbf{H}[u]}{\delta u}(\mathbf{y}) = \partial_{m+1} L \delta(\mathbf{x} - \mathbf{y}) + \sum_{i=m+2}^{2m+1} \partial_i L \partial_i \delta(\mathbf{x} - \mathbf{y}), \quad (33.10)$$

which is the unintegrated version of the classical Euler-Lagrange equation for a field in m dimensions.

33.1.3 Variational Problems

The fundamental theme of the calculus of variations is to find functions that extremize an integral and are fixed on the boundary of the integration region. A prime example is the determination of the equation of the curve

of minimum length in the xy -plane passing through two points (a_1, b_1) and (a_2, b_2) . Such a curve, written as $y = u(x)$, would minimize the integral

$$\mathbf{int}[u] \equiv \int_{a_1}^{a_2} \sqrt{1 + [u'(x)]^2} dx, \quad u(a_1) = b_1, \quad u(a_2) = b_2. \quad (33.11)$$

Note that **int** takes a function and gives a real number, i.e.—if we restrict our functions to square-integrable ones—**int** belongs to $\mathcal{L}^2(a_1, a_2)$. This is how contact is established between the calculus of variations and what we have studied so far in this chapter.

To be as general as possible, we allow the integral to contain derivatives up to the n th order. Then, using the notation of the previous chapter, we consider functions L on $M^{(n)} \subset \Omega \times U^{(n)}$, where we have replaced X with Ω , so that $M = \mathbb{R}^p \supset \Omega \times U \subset \mathbb{R}^q$.

n th-order variational
problem; Lagrangian;
functional

Definition 33.1.10 By an n th-order variational problem we mean finding the extremum of the real-valued function $\mathbf{L} : \mathcal{L}^2(\Omega) \rightarrow \mathbb{R}$ given by

$$\mathbf{L}[u] \equiv \int_{\Omega} L(x, u^{(n)}) d^p x, \quad (33.12)$$

where Ω is a subset of \mathbb{R}^p , L is a real-valued function on $\Omega \times U^{(n)}$, and $p^{(n)} = (p + n)/(n!p!)$. In this context the function L is called the **Lagrangian** of the problem, and \mathbf{L} is called a **functional**.¹

The solution to the variational problem is given by Proposition 33.1.7, moving the functional derivative inside the integral, and a straightforward (but tedious!) generalization of Eq. (33.10) to include derivatives of order higher than one. Due to the presence of the integral, the Dirac delta function and all its derivatives will be integrated out. Before stating the solution of the variational problem, let us introduce a convenient operator, using the total derivative operator introduced in Definition 32.3.3.

Euler operator **Definition 33.1.11** For $1 \leq \alpha \leq q$, the α th Euler operator is

$$\mathbb{E}_{\alpha} \equiv \sum_J (-D)_J \frac{\partial}{\partial u_J^{\alpha}}, \quad (33.13)$$

where for $J = (j_1, \dots, j_k)$,

$$(-D)_J \equiv (-1)^k D_J = (-D_{j_1})(-D_{j_2}) \cdots (-D_{j_k}),$$

and the sum extends over all multi-indices $J = (j_1, \dots, j_k)$, including $J = 0$.

The negative signs are introduced because of the integration by parts involved in the evaluation of the derivatives of the delta function. Although the sum in Eq. (33.13) extends over all multi-indices, only a finite number of

¹Do not confuse this functional with the linear functional of Chap. 2.

terms in the sum will be nonzero, because any function on which the Euler operator acts depends on a finite number of derivatives.

Theorem 33.1.12 *If u is an extremal of the variational problem (33.12), then it must be a solution of the **Euler-Lagrange equations***

Euler-Lagrange equations

$$\mathbb{E}_\alpha(L) \equiv \sum_J (-D)^J \frac{\partial L}{\partial u^\alpha_J} = 0, \quad \alpha = 1, \dots, q.$$

For the special case of $p = q = 1$, the Euler operator becomes

$$\mathbb{E} = \frac{\partial}{\partial u} + \sum_{j=1}^{\infty} (-D_x)^j \frac{\partial}{\partial u_j} = \frac{\partial}{\partial u} - D_x \frac{\partial}{\partial u_x} + D_x^2 \frac{\partial}{\partial u_{xx}} - \dots,$$

where D_x is the *total* derivative with respect to x , and u_j is the j th derivative of u with respect to x ; and the Euler-Lagrange equation for the variational problem

$$\mathbf{L}[u] \equiv \int_a^b L(x, u^{(n)}) dx$$

becomes

$$\mathbb{E}(L) = \frac{\partial L}{\partial u} + \sum_{j=1}^n (-1)^j D_x^j \frac{\partial L}{\partial u_j} = 0. \tag{33.14}$$

Since L carries derivatives up to the n -th order and each D_x carries one derivative, we conclude that Eq. (33.14) is a $2n$ -th order ODE.

Example 33.1.13 The variational problem of Eq. (33.11) has a Lagrangian

$$L(u, u^{(n)}) = L(u, u^{(1)}) = \sqrt{1 + u_x^2},$$

which is a function of the first derivative only. So, the Euler-Lagrange equation takes the form

$$0 = -D_x \frac{\partial L}{\partial u_x} = -D_x \left(\frac{u_x}{\sqrt{1 + u_x^2}} \right) = -\frac{d}{dx} \left(\frac{u_x}{\sqrt{1 + u_x^2}} \right) = -\frac{u_{xx}}{(1 + u_x^2)^{3/2}},$$

or $u_{xx} = 0$, so that $u = f(x) = c_1x + c_2$. The solution to the variational problem is a straight line passing through the two points (a_1, b_1) and (a_2, b_2) .

Historical Notes

Leonhard Euler (1707–1783) was Switzerland’s foremost scientist and one of the three greatest mathematicians of modern times (Gauss and Riemann being the other two). He was perhaps the most prolific author of all time in any field. From 1727 to 1783 his writings poured out in a seemingly endless flood, constantly adding knowledge to every known branch of pure and applied mathematics, and also to many that were not known until he created them. He averaged about 800 printed pages a year throughout his long life, and yet he almost always had something worthwhile to say. The publication of his complete works was started in 1911, and the end is not in sight. This edition was planned



Leonhard Euler
1707–1783

to include 887 titles in 72 volumes, but since that time extensive new deposits of previously unknown manuscripts have been unearthed, and it is now estimated that more than 100 large volumes will be required for completion of the project. Euler evidently wrote mathematics with the ease and fluency of a skilled speaker discoursing on subjects with which he is intimately familiar. His writings are models of relaxed clarity. He never condensed, and he reveled in the rich abundance of his ideas and the vast scope of his interests. The French physicist Arago, in speaking of Euler's incomparable mathematical facility, remarked that "He calculated without apparent effort, as men breathe, or as eagles sustain themselves in the wind." He suffered total blindness during the last 17 years of his life, but with the aid of his powerful memory and fertile imagination, and with assistants to write his books and scientific papers from dictation, he actually increased his already prodigious output of work.

Euler was a native of Basel and a student of Johann Bernoulli at the University, but he soon outstripped his teacher. He was also a man of broad culture, well versed in the classical languages and literatures (he knew the Aeneid by heart), many modern languages, physiology, medicine, botany, geography, and the entire body of physical science as it was known in his time. His personal life was as placid and uneventful as is possible for a man with 13 children.

Though he was not himself a teacher, Euler has had a deeper influence on the teaching of mathematics than any other person. This came about chiefly through his three great treatises: *Introductio in Analysin Infinitorum* (1748); *Institutiones Calculi Differentialis* (1755); and *Institutiones Calculi Integralis* (1768–1794). There is considerable truth in the old saying that all elementary and advanced calculus textbooks since 1748 are essentially copies of Euler or copies of copies of Euler. These works summed up and codified the discoveries of his predecessors, and are full of Euler's own ideas. He extended and perfected plane and solid analytic geometry, introduced the analytic approach to trigonometry, and was responsible for the modern treatment of the functions $\ln x$ and e^x . He created a consistent theory of logarithms of negative and imaginary numbers, and discovered that $\ln x$ has an infinite number of values. It was through his work that the symbols e , π , and $i = \sqrt{-1}$ became common currency for all mathematicians, and it was he who linked them together in the astonishing relation $e^{i\pi} = -1$. Among his other contributions to standard mathematical notation were $\sin x$, $\cos x$, the use of $f(x)$ for an unspecified function, and the use of \sum for summation.

His work in all departments of analysis strongly influenced the further development of this subject through the next two centuries. He contributed many important ideas to differential equations, including substantial parts of the theory of second-order linear equations and the method of solution by power series. He gave the first systematic discussion of the calculus of variations, which he founded on his basic differential equation for a minimizing curve. He discovered the integral defining the gamma function and developed many of its applications and special properties. He also worked with Fourier series, encountered the Bessel functions in his study of the vibrations of a stretched circular membrane, and applied Laplace transforms to solve differential equations—all before Fourier, Bessel, and Laplace were born.

E.T. Bell, the well-known historian of mathematics, observed that "One of the most remarkable features of Euler's universal genius was its equal strength in both of the main currents of mathematics, the continuous and the discrete." In the realm of the discrete, he was one of the originators of number theory and made many far-reaching contributions to this subject throughout his life. In addition, the origins of topology—one of the dominant forces in modern mathematics—lie in his solution of the Königsberg bridge problem and his formula $V - E + F = 2$ connecting the numbers of vertices, edges, and faces of a simple polyhedron.

The distinction between pure and applied mathematics did not exist in Euler's day, and for him the entire physical universe was a convenient object whose diverse phenomena offered scope for his methods of analysis. The foundations of classical mechanics had been laid down by Newton, but Euler was the principal architect. In his treatise of 1736 he was the first to explicitly introduce the concept of a mass-point, or particle, and he was also the first to study the acceleration of a particle moving along any curve and to use the notion of a vector in connection with velocity and acceleration. His continued successes in mathematical physics were so numerous, and his influence was so pervasive, that most of his discoveries are not credited to him at all and are taken for granted in the physics

community as part of the natural order of things. However, we do have Euler's angles for the rotation of a rigid body, and the all-important *Euler-Lagrange equation* of variational dynamics.

Euler was the Shakespeare of mathematics—universal, richly detailed, and inexhaustible.

The variational problem is a problem involving only the first functional derivative, or the **first variation**. We know from calculus that the first derivative by itself cannot determine the nature of the extremum. To test whether the point in question is maximum or minimum, we need all the second derivatives (see Example 6.6.9). One uses these derivatives to expand the functional in a Taylor series up to the second order. The sign of the second order contribution determines whether the functional is maximum or minimum at the extremal point. In analogy with Example 6.6.9, we expand $\mathbf{L}[u]$ about f up to the second-order derivative:

$$\begin{aligned} \mathbf{L}[u] = \mathbf{L}[f] &+ \int_{\Omega} d^p y \left. \frac{\delta \mathbf{L}}{\delta u(\mathbf{y})} \right|_{u=f} (u(\mathbf{y}) - f(\mathbf{y})) \\ &+ \frac{1}{2} \int_{\Omega} d^p y \int_{\Omega} d^p y' \left. \frac{\delta^2 \mathbf{L}}{\delta u(\mathbf{y}) \delta u(\mathbf{y}')} \right|_{u=f} (u(\mathbf{y}) - f(\mathbf{y})) (u(\mathbf{y}') - f(\mathbf{y}')). \end{aligned}$$

The integrals have replaced the sums of the discrete case of Taylor expansion of the multivariable functions. Since we are interested in comparing u with the f that extremizes the functional, the second term vanishes and we get

$$\begin{aligned} \mathbf{L}[u] = \mathbf{L}[f] &+ \frac{1}{2} \int_{\Omega} d^p y \int_{\Omega} d^p y' \left. \frac{\delta^2 \mathbf{L}}{\delta u(\mathbf{y}) \delta u(\mathbf{y}')} \right|_{u=f} \\ &\cdot [(u(\mathbf{y}) - f(\mathbf{y})) (u(\mathbf{y}') - f(\mathbf{y}'))]. \end{aligned} \quad (33.15)$$

Historical Notes

Joseph Louis Lagrange (1736–1813) was born Giuseppe Luigi Lagrangia but adopted the French version of his name. He was the eldest of eleven children, most of whom did not reach adulthood. His father destined him for the law—a profession that one of his brothers later pursued—and Lagrange offered no objections. But having begun the study of physics and geometry, he quickly became aware of his talents and henceforth devoted himself to the exact sciences. Attracted first by geometry, at the age of seventeen he turned to analysis, then a rapidly developing field.

In 1755, in a letter to the geometer Giulio da Fagnano, Lagrange speaks of one of Euler's papers published at Lausanne and Geneva in 1744. The same letter shows that as early as the end of 1754 Lagrange had found interesting results in this area, which was to become the *calculus of variations* (a term coined by Euler in 1766). In the same year, Lagrange sent Euler a summary, written in Latin, of the purely analytical method that he used for this type of problem. Euler replied to Lagrange that he was very interested in the technique. Lagrange's merit was likewise recognized in Turin; and he was named, by a royal decree, professor at the Royal Artillery School with an annual salary of 250 crowns—a sum never increased in all the years he remained in his native country. Many years later, in a letter to d'Alembert, Lagrange confirmed that this method of maxima and minima was the first fruit of his studies—he was only nineteen when he devised it—and that he regarded it as his best work in mathematics. In 1756, in a letter to Euler that has been lost, Lagrange, applying the calculus of variations to mechanics, generalized Euler's earlier work on the trajectory described by a material point subject to the influence of central forces to an arbitrary system of bodies, and derived from it a procedure for solving all the problems of dynamics.

The first variation is not sufficient for a full knowledge of the nature of the extremum!



Joseph Louis Lagrange
1736–1813

In 1757 some young Turin scientists, among them Lagrange, founded a scientific society that was the origin of the Royal Academy of Sciences of Turin. One of the main goals of this society was the publication of a miscellany in French and Latin, *Miscellanea Taurinensia ou Mélanges de Turin*, to which Lagrange contributed fundamentally. These contributions included works on the calculus of variations, probability, vibrating strings, and the principle of least action.

To enter a competition for a prize, in 1763 Lagrange sent to the Paris Academy of Sciences a memoir in which he provided a satisfactory explanation of the translational motion of the moon. In the meantime, the Marquis Caraccioli, ambassador from the kingdom of Naples to the court of Turin, was transferred by his government to London. He took along the young Lagrange, who until then seems never to have left the immediate vicinity of Turin. Lagrange was warmly received in Paris, where he had been preceded by his memoir on lunar libration. He may perhaps have been treated too well in the Paris scientific community, where austerity was not a leading virtue. Being of a delicate constitution, Lagrange fell ill and had to interrupt his trip. In the spring of 1765 Lagrange returned to Turin by way of Geneva.

In the autumn of 1765 d'Alembert, who was on excellent terms with Frederick II of Prussia, and familiar with Lagrange's work through *Mélanges de Turin*, suggested to Lagrange that he accept the vacant position in Berlin created by Euler's departure for St. Petersburg. It seems quite likely that Lagrange would gladly have remained in Turin had the court of Turin been willing to improve his material and scientific situation. On 26 April, d'Alembert transmitted to Lagrange the very precise and advantageous propositions of the king of Prussia. Lagrange accepted the proposals of the Prussian king and, not without difficulties, obtained his leave through the intercession of Frederick II with the king of Sardinia. Eleven months after his arrival in Berlin, Lagrange married his cousin Vittoria Conti who died in 1783 after a long illness. With the death of Frederick II in August 1786 he also lost his strongest support in Berlin. Advised of the situation, the princes of Italy zealously competed in attracting him to their courts. In the meantime the French government decided to bring Lagrange to Paris through an advantageous offer. Of all the candidates, Paris was victorious.

Lagrange left Berlin on 18 May 1787 to become *pensionnaire vétérane* of the Paris Academy of Sciences, of which he had been a foreign associate member since 1772. Warmly welcomed in Paris, he experienced a certain lassitude and did not immediately resume his research. Yet he astonished those around him by his extensive knowledge of metaphysics, history, religion, linguistics, medicine, and botany.

In 1792 Lagrange married the daughter of his colleague at the Academy, the astronomer Pierre Charles Le Monnier. This was a troubled period, about a year after the flight of the king and his arrest at Varennes. Nevertheless, on 3 June the royal family signed the marriage contract "as a sign of its agreement to the union." Lagrange had no children from this second marriage, which, like the first, was a happy one.

When the academy was suppressed in 1793, many noted scientists, including Lavoisier, Laplace, and Coulomb were purged from its membership; but Lagrange remained as its chairman. For the next ten years, Lagrange survived the turmoil of the aftermath of the French Revolution, but by March of 1813, he became seriously ill. He died on the morning of 11 April 1813, and three days later his body was carried to the Panthéon. The funeral oration was given by Laplace in the name of the Senate.

A straight line segment is indeed the *shortest* distance between two points.

Example 33.1.14 Let us apply Eq. (33.15) to the extremal function of Example 33.1.13 to see if the line is truly the *shortest* distance between two points. The first functional derivative, obtained using Eq. (33.9), is simply $\mathbb{E}(L)$:

$$\frac{\delta \mathbf{L}}{\delta u(y)} = \mathbb{E}(L) = -\frac{u_{yy}}{(1 + u_y^2)^{3/2}}.$$

To find the second variational derivative, we use the basic relations (33.6), (33.7), and the chain rule (33.10):

$$\begin{aligned} & \left. \frac{\delta^2 \mathbf{L}}{\delta u(y') \delta u(y)} \right|_{u=f} \\ &= - \frac{\delta}{\delta u(y')} \left[\frac{u_{yy}}{(1 + u_y^2)^{3/2}} \right] \Big|_{u=f} \\ &= - \left\{ (1 + u_y^2)^{-3/2} \frac{\delta u_{yy}}{\delta u(y')} - u_{yy} \frac{3}{2} (1 + u_y^2)^{-5/2} 2u_y \frac{\delta u_y}{\delta u(y')} \right\} \Big|_{u=f} \\ &= - \frac{\delta''(y - y')}{(1 + u_y^2)^{3/2}} \Big|_{u=f} = - \frac{\delta''(y - y')}{(1 + c_1^2)^{3/2}}, \end{aligned}$$

because $u_{yy} = 0$ and $u_y = c_1$ when $u = f$. Inserting this in Eq. (33.15), we obtain

$$\begin{aligned} \mathbf{L}[u] &= \mathbf{L}[f] - \frac{1}{2(1 + c_1^2)^{3/2}} \\ &\quad \times \int_{a_1}^{a_2} dy \int_{a_1}^{a_2} dy' \delta''(y - y')(u(y) - f(y))(u(y') - f(y')) \\ &= \mathbf{L}[f] - \frac{1}{2(1 + c_1^2)^{3/2}} \int_{a_1}^{a_2} dy (u(y) - f(y)) \frac{d^2}{dy^2} (u(y) - f(y)). \end{aligned}$$

The last integral can be integrated by parts, with the result

$$\underbrace{(u(y) - f(y)) \frac{d}{dy} (u(y) - f(y)) \Big|_{a_1}^{a_2}}_{=0 \text{ because } u(a_i) = f(a_i), i = 1, 2} - \int_{a_1}^{a_2} dy \left[\frac{d}{dy} (u(y) - f(y)) \right]^2.$$

Therefore,

$$\mathbf{L}[u] = \mathbf{L}[f] + \underbrace{\frac{1}{2(1 + c_1^2)^{3/2}} \int_{a_1}^{a_2} dy \left[\frac{d}{dy} (u(y) - f(y)) \right]^2}_{\text{always positive}}.$$

It follows that $\mathbf{L}[f] < \mathbf{L}[u]$, i.e., that f indeed gives the shortest distance.

Example 33.1.15 In the special theory of relativity, the element of the invariant “length”, or proper time, is given by $\sqrt{dt^2 - dx^2}$. Thus, the total proper time between two events (t_1, a_1) and (t_2, a_2) is given by

$$\mathbf{L}[x] = \int_{t_1}^{t_2} \sqrt{1 - x_t^2} dt, \quad x_t \equiv \frac{dx}{dt}.$$

The extremum of this variational problem is exactly the same as in the previous example, the only difference being a sign. In fact, the reader may verify that

$$\frac{\delta \mathbf{L}[x]}{\delta x(s)} = \mathbb{E}(L) = \frac{x_{ss}}{(1 - x_s^2)^{3/2}},$$

connection between
variational problem and
the twin paradox

and therefore, $x = f(t) = c_1t + c_2$ extremizes the functional. The second variational derivative can be obtained as before. It is left for the reader to show that in the case at hand, $\mathbf{L}[f] > \mathbf{L}[x]$, i.e., that f gives the *longest* proper time. Since the function $f(t) = c_1t + c_2$ corresponds to an inertial (unaccelerated) observer, we conclude that

Box 33.1.16 *Accelerated observers measure a shorter proper time between any two events than inertial observers.*

This is the content of the famous **twin paradox**, in which the twin who goes to a distant galaxy and comes back (therefore being accelerated) will return younger than her (unaccelerated) twin.

33.1.4 Divergence and Null Lagrangians

The variational problem integrates a Lagrangian over a region Ω of \mathbb{R}^p . If the Lagrangian happens to be the divergence of a function that vanishes at the boundary of Ω , the variational problem becomes trivial, because all functions will extremize the functional. We now study such Lagrangians in more detail.

Definition 33.1.17 Let $\{F_i : M^{(n)} \rightarrow \mathbb{R}\}_{i=1}^p$ be functions on $M^{(n)}$, and $\mathbf{F} = (F_1, \dots, F_p)$. The **total divergence** of \mathbf{F} is defined to be²

$$\mathbf{D} \cdot \mathbf{F} \equiv \sum_{j=1}^p D_j F_j,$$

where D_j is the total derivative with respect to x^j .

Now suppose that the Lagrangian $L(x, u^{(n)})$ can be written as the divergence of some p -tuple \mathbf{F} . Then by the divergence theorem,

$$\mathbf{L}[u] = \int_{\Omega} L(x, u^{(n)}) d^p x = \int_{\Omega} \mathbf{D} \cdot \mathbf{F} d^p x = \int_{\partial\Omega} \mathbf{F} \cdot d\mathbf{a}$$

for any $u = f(x)$ and any domain Ω . It follows that $\mathbf{L}[f]$ depends on the behavior of f only at the boundary. Since in a typical problem no variation takes place at the boundary, all functions that satisfy the boundary conditions will be solutions of the variational problem, i.e., they satisfy the Euler-Lagrange equation. Lagrangians that satisfy the Euler-Lagrange equation for all u and x are called **null Lagrangians**. It turns out that null Lagrangians are the *only* such solutions of the Euler-Lagrange equation (for a proof, see [Olve 86, pp. 252–253]).

null Lagrangians

²The reader need not be concerned about lack of consistency in the location of indices (upper vs. lower), because we are dealing with indexed objects, such as F_i , which are *not* tensors!

Theorem 33.1.18 *A function $L(x, u^{(n)})$ satisfies $\mathbb{E}(L) \equiv 0$ for all x and u if and only if $L = \mathbf{D} \cdot \mathbf{F}$ for some p -tuple of functions $\mathbf{F} = (F_1, \dots, F_p)$ of x, u , and the derivatives of u .*

In preparation for the investigation of symmetries of the variational problems, we look into the effect of a change of variables on the variational problem and the Euler operator. This is important, because the variational problem should be independent of the variables chosen. Let

$$\tilde{x} = \Psi(x, u), \quad \tilde{u} = \Phi(x, u) \tag{33.16}$$

be any change of variables. Then by prolongation, we also have $\tilde{u}^{(n)} = \Phi^{(n)}(x, u^{(n)})$ for the derivatives. Substituting $u = f(x)$ and all its prolongations in terms of the new variables, the functional

$$\mathbf{L}[f] = \int_{\Omega} L(x, \text{pr}^{(n)} f(x)) d^p x$$

will be transformed into

$$\tilde{\mathbf{L}}[\tilde{f}] = \int_{\tilde{\Omega}} \tilde{L}(\tilde{x}, \text{pr}^{(n)} \tilde{f}(\tilde{x})) d^p \tilde{x},$$

where the transformed domain, defined by

$$\tilde{\Omega} = \{ \tilde{x} = \Psi(x, f(x)) \mid x \in \Omega \},$$

will depend not only on the original domain Ω , but also on the function f . The new Lagrangian is then related to the old one by the change of variables formula for multiple integrals:

$$L(x, \text{pr}^{(n)} f(x)) = \tilde{L}(\tilde{x}, \text{pr}^{(n)} \tilde{f}(\tilde{x})) \det \mathbf{J}(x, \text{pr}^{(1)} f(x)), \tag{33.17}$$

where \mathbf{J} is the Jacobian matrix of the change of variables induced by the function f .

Starting with Eqs. (33.16) and (33.17), one can obtain the transformation formula for the Euler operator stated below. The details can be found in [Olve 86, pp. 254–255].

Theorem 33.1.19 *Let $L(x, u^{(n)})$ and $\tilde{L}(\tilde{x}, \tilde{u}^{(n)})$ be two Lagrangians related by the change of variable formulas (33.16) and (33.17). Then*

$$\mathbb{E}_{\alpha}(L) = \sum_{\beta=1}^q F_{\alpha\beta}(x, u^{(1)}) \tilde{\mathbb{E}}_{\beta}(\tilde{L}), \quad \alpha = 1, \dots, q$$

where $\tilde{\mathbb{E}}_{\beta}$ is the Euler operator associated with the new variables, and

$$F_{\alpha\beta} \equiv \det \begin{pmatrix} D_1 \Psi^1 & \dots & D_p \Psi^1 & \partial \Psi^1 / \partial u^{\alpha} \\ \vdots & & \vdots & \vdots \\ D_1 \Psi^p & \dots & D_p \Psi^p & \partial \Psi^p / \partial u^{\alpha} \\ D_1 \Phi^{\beta} & \dots & D_p \Phi^{\beta} & \partial \Phi^{\beta} / \partial u^{\alpha} \end{pmatrix}.$$

33.2 Symmetry Groups of Variational Problems

In the theory of fields, as well as in mechanics, condensed matter theory, and statistical mechanics, the starting point is usually a Lagrangian. The variational problem of this Lagrangian gives the classical equations of motion, and its symmetries lead to the important conservation laws.

Definition 33.2.1 A local group of transformations G acting on $M \subset \Omega_0 \times U$ is a **variational symmetry group** of the functional

$$\mathbf{L}[u] = \int_{\Omega_0} L(x, u^{(n)}) d^p x \quad (33.18)$$

if whenever (the closure of) Ω lies in Ω_0 , f is a function over Ω whose graph is in M , and $g \in G$ is such that $\tilde{f} = g \cdot f$ is a single-valued function defined over $\tilde{\Omega}$, then

$$\int_{\tilde{\Omega}} L(\tilde{x}, \text{pr}^{(n)} \tilde{f}(\tilde{x})) d^p \tilde{x} = \int_{\Omega} L(x, \text{pr}^{(n)} f(x)) d^p x. \quad (33.19)$$

“Symmetry of the Lagrangian” is really the symmetry group of the variational problem!

In the physics community, the symmetry group of the variational problem is (somewhat erroneously) called the **symmetry of the Lagrangian**. Note that if we had used \tilde{L} in the LHS of Eq. (33.19), we would have obtained an identity valid for *all* Lagrangians because of Eq. (33.17) and the formula for the change in the volume element of integration. Only *symmetric Lagrangians* will satisfy Eq. (33.19).

As we have experienced so far, the action of a group can be very complicated and very nonlinear. On the other hand, the *infinitesimal* action simplifies the problem considerably. Fortunately, we have (see [Olve 86, pp. 257–258] for a proof).

Theorem 33.2.2 A local group of transformations G acting on $M \subset \Omega_0 \times U$ is a variational symmetry group of the functional (33.18) if and only if

$$\text{pr}^{(n)} \mathbf{v}(L) + L\mathbf{D} \cdot \mathbf{X} = 0 \quad (33.20)$$

for all $(x, u^{(n)}) \in M^{(n)}$ and every infinitesimal generator

$$\mathbf{v} = \sum_{i=1}^p X^i(x, u) \frac{\partial}{\partial x^i} + \sum_{\alpha=1}^q U^\alpha(x, u) \frac{\partial}{\partial u^\alpha}$$

of G , where $\mathbf{X} \equiv (X^1, \dots, X^p)$.

Example 33.2.3 Consider the case of $p = 1 = q$, and assume that the Lagrangian is independent of x but depends on $u \in \mathcal{L}^2(a, b)$ and its first derivative. Then the variational problem takes the form

$$\mathbf{L}[u] = \int_a^b L(u^{(1)}) dx \equiv \int_a^b L(u, u_x) dx.$$

Since derivatives are independent of translations, we expect translations to be part of the symmetry group of this variational problem. Let us verify this. The infinitesimal generator of translation is ∂_x , which is its own prolongation. Therefore, with $X = 1$ and $U = 0$, it follows that

$$\text{pr}^{(1)}\mathbf{v}(L) + L\mathbf{D} \cdot \mathbf{X} = \partial_x L + LD_x X = 0 + 0 = 0.$$

Example 33.2.4 As a less trivial case, consider the proper time of Example 33.1.15. Lorentz transformations generated by³ $\mathbf{v} = u\partial_x + x\partial_u$ are symmetries of that variational problem. We can verify this by noting that the first prolongation of \mathbf{v} is, as the reader is urged to verify,

$$\text{pr}^{(1)}\mathbf{v} = \mathbf{v} + (1 - u_x^2) \frac{\partial}{\partial u_x}.$$

Therefore,

$$\text{pr}^{(1)}\mathbf{v}(L) = 0 + 0 + \left((1 - u_x^2) \frac{1}{2} (-2u_x) \right) \frac{1}{\sqrt{1 - u_x^2}} = -u_x \sqrt{1 - u_x^2}.$$

On the other hand, since $X = u$ and $U = x$,

$$LD_x(X) = \sqrt{1 - u_x^2} D_x(u) = \sqrt{1 - u_x^2} u_x,$$

so that Eq. (33.20) is satisfied.

In the last chapter, we studied the symmetries of the DEs in some detail. This chapter introduces us to a particular DE that arises from a variational problem, namely, the Euler-Lagrange equation. The natural question to ask now is: How does the variational symmetry manifest itself in the Euler-Lagrange equation? Barring some technical difficulties, we note that for any change of variables, if $u = f(x)$ is an extremal of the variational problem $\mathbf{L}[u]$, then $\tilde{u} = \tilde{f}(\tilde{x})$ is an extremal of the variational problem $\tilde{\mathbf{L}}[\tilde{u}]$. In particular, if the change is achieved by the action of the variational symmetry group, $(\tilde{x}, \tilde{u}) = g \cdot (x, u)$ for some $g \in G$, then $\tilde{\mathbf{L}}[\tilde{u}] = \mathbf{L}[\tilde{u}]$, and $g \cdot f$ is also an extremal of \mathbf{L} . We thus have

Theorem 33.2.5 *If G is the variational symmetry group of a functional, then G is also the symmetry group of the associated Euler-Lagrange equations.*

The converse is *not* true! There are symmetry groups of the Euler-Lagrange equations that are not the symmetry group of the variational problem. Problem 33.8 illustrates this for $p = 3$, $q = 1$, and the functional

$$\mathbf{L}[u] = \frac{1}{2} \iiint (u_t^2 - u_x^2 - u_y^2) dx dy dt, \quad (33.21)$$

³In order to avoid confusion in applying formula (33.20), we use x (instead of t) as the independent variable and u (instead of x) as the dependent variable.

Symmetries of the Euler-Lagrange equations are not necessarily the symmetries of the corresponding variational problem!

whose Euler-Lagrange equation is the wave equation. The reader is asked to show that while the rotations and Lorentz boosts of Table 32.3 are variational symmetries, the dilatations and inversions (special conformal transformations) are not.

We now treat the case of $p = 1 = q$, whose Euler-Lagrange equation is an ODE. Recall that the knowledge of a symmetry group of an ODE led to a reduction in the order of that ODE. Let us see what happens in the present case. Suppose $\mathbf{v} = X\partial_x + U\partial_u$ is the infinitesimal generator of a 1-parameter group of variational symmetries of \mathbf{L} . By an appropriate coordinate transformation from (x, u) to (y, w) , as in Sect. 32.5, \mathbf{v} will reduce to $\partial/\partial w$, whose prolongation is also $\partial/\partial w$. In terms of the new coordinates, Eq. (33.20) will reduce to $\partial\tilde{L}/\partial w = 0$; i.e., the new Lagrangian is independent of w , and the Euler-Lagrange equation (33.14) becomes

$$0 = \mathbb{E}(L) = \sum_{j=1}^n (-1)^j D_y^j \frac{\partial \tilde{L}}{\partial w_j} = (-D_y) \left[\sum_{j=0}^{n-1} (-D_y)^j \frac{\partial \tilde{L}}{\partial w_{j+1}} \right]. \quad (33.22)$$

Therefore, the expression in the brackets is some constant λ (because D_y is a total derivative). Furthermore, if we introduce $v = w_y$, the expression in the brackets becomes the Euler-Lagrange equation of the variational problem

$$\hat{\mathbf{L}}[v] = \int \hat{L}(y, v^{(n-1)}) dy, \quad \text{where} \quad \hat{L}(y, v^{(n-1)}) = \tilde{L}(y, w_y, \dots, w_n),$$

and every solution $w = f(y)$ of the original $(2n)$ th-order Euler-Lagrange equation corresponds to the $(2n - 2)$ nd-order equation

$$\hat{\mathbb{E}}(\hat{L}) = \frac{\partial \hat{L}}{\partial y} + \sum_{j=1}^{n-1} (-D_y)^j \frac{\partial \hat{L}}{\partial v_j} = \lambda. \quad (33.23)$$

Moreover, this equation can be written as the Euler-Lagrange equation for

$$\hat{\mathbf{L}}_\lambda[v] = \int [\hat{L}(y, v^{(n-1)}) - \lambda v] dy,$$

Lagrange multiplier

and λ can be thought of as a **Lagrange multiplier**, so that in analogy with the multivariable extremal problem,⁴ the extremization of $\hat{\mathbf{L}}_\lambda[v]$ becomes equivalent to that of $\hat{\mathbf{L}}[v]$ subject to the constraint $\int v dy = 0$. We summarize the foregoing discussion in the following theorem.

Theorem 33.2.6 *Let $p = 1 = q$, and $\mathbf{L}[u]$ an n th-order variational problem with a 1-parameter group of variational symmetries G . Then there exists a one-parameter family of variational problems $\hat{\mathbf{L}}_\lambda[v]$ of order $n - 1$ such that every solution of the Euler-Lagrange equation for $\mathbf{L}[u]$ can be found by integrating the solutions to the Euler-Lagrange equation for $\hat{\mathbf{L}}_\lambda[v]$.*

⁴See [Math 70, pp. 331–341] for a discussion of Lagrange multipliers and their use in variational techniques, especially those used in approximating solutions of the Schrödinger equation.

Thus, we have the following important result:

Box 33.2.7 A 1-parameter variational symmetry of a functional reduces the order of the corresponding Euler-Lagrange equation by two.

This conclusion is to be contrasted with the symmetry of ODEs, where each 1-parameter group of symmetries reduces the order of the ODE by 1. It follows from Box 33.2.7 that the ODEs of order $2n$ derived from a variational problem—the Euler-Lagrange equation—are special.

Example 33.2.8 A first-order variational problem with a 1-parameter group of symmetries can be integrated out. By transforming to a new coordinate system, we can always assume that the Lagrangian is independent of the *dependent variable* (see Proposition 32.5.1). The Euler-Lagrange equation in this case becomes

$$0 = \mathbb{E}(L) = \underbrace{\frac{\partial L}{\partial u}}_{=0} - D_x \frac{\partial L}{\partial u_x} \Rightarrow \frac{\partial L}{\partial u_x}(x, u_x) = \lambda.$$

Solving this implicit relation, we get $u_x = F(x, \lambda)$, which can be integrated to give u as a function of x (and λ).

The procedure can be generalized to r -parameter symmetry groups, but the order cannot be expected to be reduced by 2 unless the group is abelian. We shall not pursue this matter here, but ask the reader to refer to Problem 33.9.

33.3 Conservation Laws and Noether's Theorem

A conserved physical quantity is generally defined as a quantity whose flux through any arbitrary closed surface is equal to (the negative of) the rate of depletion of the quantity in the volume enclosed. This statement, through the use of the divergence theorem, translates into a relation connecting the time rate of change of the density and the divergence of the current corresponding to the physical quantity. Treating time and space coordinates as independent variables and extending to p independent variables, we have the following:

Definition 33.3.1 A **conservation law** for a system of differential equations $\Delta(x, u^{(n)}) = 0$ is a divergence expression $\mathbf{D} \cdot \mathbf{J} = 0$ valid for all solutions $u = f(x)$ of the system. Here, current density and
conservation law

$$\mathbf{J} \equiv (J_1(x, u^{(n)}), J_2(x, u^{(n)}), \dots, J_p(x, u^{(n)}))$$

is called **current density**.

For $p = 1 = q$, i.e., for a system of ODEs, a conservation law takes the form $D_x J(x, u^{(n)}) = 0$ for all solutions $u = f(x)$ of the system. This requires $J(x, u^{(n)})$ to be a constant, i.e., that $J(x, u^{(n)})$ be a **constant of the motion**, or, as it is sometimes called, the *first integral* of the system.

In order to understand conservation laws, we need to get a handle on those conservation laws that are trivially satisfied.

Definition 33.3.2 If the current density \mathbf{J} itself vanishes for all solutions $u = f(x)$ of the system $\Delta(x, u^{(n)}) = 0$, then $\mathbf{D} \cdot \mathbf{J} = 0$ is called a **trivial conservation law of the first kind**.

To eliminate this kind of triviality, one solves the system and its prolongations $\Delta^{(k)}(x, u^{(n)}) = 0$ for some of the variables u_j^α in terms of the remaining variables and substitutes the latter whenever they occur. For example, one can differentiate the evolution equation $u_t = F(x, u^{(n)})$ —in which $u^{(n)}$ have derivatives with respect to x only—with respect to t and x sufficient number of times (this is what is meant by “prolongation” of the system of equations) and solve for all derivatives of u involving time. Then, in the conservation law, substitute for any such derivatives to obtain a conservation law involving only x derivatives of u .

Example 33.3.3 The current density $\mathbf{J}_1 = (\frac{1}{2}u_t^2 + \frac{1}{2}u_x^2, -u_t u_x)$ is easily seen to be conserved for the system of first-order DEs

$$u_t = v_x, \quad u_x = v_t.$$

By eliminating all the time derivatives in \mathbf{J}_1 , we obtain $\mathbf{J}_2 = (\frac{1}{2}u_x^2 + \frac{1}{2}v_x^2, -u_x v_x)$, which is also conserved. However, the difference between these two currents,

$$\mathbf{J} = \mathbf{J}_1 - \mathbf{J}_2 = \left(\frac{1}{2}u_t^2 - \frac{1}{2}v_x^2, u_x v_x - u_t u_x \right),$$

satisfies a trivial conservation law of the first kind, because the components of \mathbf{J} vanish on the solutions of the system.

Definition 33.3.4 If the current density \mathbf{J} satisfies $\mathbf{D} \cdot \mathbf{J} = 0$ for all functions $u = f(x)$, even if they are not solutions of the system of DEs, the divergence identity is called a **trivial conservation law of the second kind**. In this case \mathbf{J} is called a **null divergence**.

If we treat J_i as the components of a $(p - 1)$ -form ω , so that the exterior derivative $d\omega$ is the divergence of \mathbf{J} (times a volume element), then the triviality of the conservation law for \mathbf{J} is equivalent to the fact that ω is closed. By the converse of the Poincaré lemma, there must be a $(p - 2)$ -form η such that $\omega = d\eta$. In the context of this chapter, we have the following theorem.

Theorem 33.3.5 Suppose $\mathbf{J} = (J_1(x, u^{(n)}), \dots, J_p(x, u^{(n)}))$ is a p -tuple of functions on $X \times U^{(n)}$. Then \mathbf{J} is a null divergence if and only if there exist smooth functions $A_{kj}(x, u^{(n)})$, $j, k = 1, \dots, p$, antisymmetric in their indices, such that

$$J_k = \sum_{j=1}^p D_j A_{kj}, \quad j = 1, \dots, p. \tag{33.24}$$

Definition 33.3.6 We say that $\mathbf{D} \cdot \mathbf{J} = 0$ is a **trivial conservation law** if there exist antisymmetric smooth functions $A_{kj}(x, u^{(n)})$ satisfying Eq. (33.24) for all solutions of the system of DEs $\Delta(x, u^{(n)}) = 0$. Two conservation laws are **equivalent** if they differ by a trivial conservation law.

We shall not distinguish between conservation laws that are equivalent. It turns out that to within this equivalence, some systems of DEs Δ_v have current densities \mathbf{J} such that

$$\mathbf{D} \cdot \mathbf{J} = \sum_{v=1}^l Q_v \Delta_v \quad \text{for some } l\text{-tuple } \mathbf{Q} = (Q_1, \dots, Q_l), \tag{33.25}$$

where $\{Q_v\}$ are smooth functions of x, u , and all derivatives of u .

Definition 33.3.7 Equation (33.25) is called the **characteristic form** of the conservation law for the current density \mathbf{J} , and the l -tuple \mathbf{Q} , the **characteristic** of the conservation law.

We are now in a position to prove the celebrated Noether's theorem. However, we first need a lemma.

Lemma 33.3.8 Let $\mathbf{v} = \sum_{i=1}^p X^i \partial/\partial x^i + \sum_{\alpha=1}^q U^\alpha \partial/\partial u^\alpha$ where X^i and U^α are functions of x and u . Let

$$Q^\alpha(x, u^{(1)}) \equiv U^\alpha(x, u) - \sum_{i=1}^p X^i(x, u) u_i^\alpha, \quad \alpha = 1, \dots, q.$$

Then

$$\text{pr}^{(n)} \mathbf{v} = \text{pr}^{(n)} \mathbf{v}_Q + \sum_{i=1}^p X^i D_i, \tag{33.26}$$

where

$$\mathbf{v}_Q \equiv \sum_{\alpha=1}^q Q^\alpha(x, u^{(1)}) \frac{\partial}{\partial u^\alpha}, \quad \text{pr}^{(n)} \mathbf{v}_Q \equiv \sum_{\alpha=1}^q \sum_J D_J Q^\alpha \frac{\partial}{\partial u_J^\alpha}.$$

The sum over J extends over all multi-indices with $0 \leq |J| \leq n$, with the $|J| = 0$ term being simply \mathbf{v}_Q .

Proof Substitute Q^α in the definition of U_J^α as given in Theorem 32.3.5 to obtain

$$U_J^\alpha = D_J Q^\alpha + \sum_{i=1}^p X^i u_{J,i}^\alpha,$$

where $U_0^\alpha = Q^\alpha + \sum_{i=1}^p X^i u_i^\alpha = U^\alpha$. It follows that (with $J = 0$ included in the sum)

$$\begin{aligned} \text{pr}^{(n)} \mathbf{v} &= \sum_{i=1}^p X^i \frac{\partial}{\partial x^i} + \sum_J \left[\sum_{\alpha=1}^q D_J Q^\alpha + \sum_{i=1}^p X^i u_{J,i}^\alpha \right] \frac{\partial}{\partial u_J^\alpha} \\ &= \sum_{\alpha=1}^q \sum_J D_J Q^\alpha \frac{\partial}{\partial u_J^\alpha} + \sum_{i=1}^p X^i \underbrace{\left[\frac{\partial}{\partial x^i} + \sum_{\alpha=1}^q \sum_J u_{J,i}^\alpha \frac{\partial}{\partial u_J^\alpha} \right]}_{=D_i \text{ by Proposition 32.3.4}}, \end{aligned}$$

and the lemma is proved. □

The celebrated Noether's theorem connecting symmetries to conservation laws

Theorem 33.3.9 (Noether's theorem) *Let*

$$\mathbf{v} = \sum_{i=1}^p X^i \partial / \partial x^i + \sum_{\alpha=1}^q U^\alpha \partial / \partial u^\alpha$$

be the infinitesimal generator of a local 1-parameter group of symmetries G of the variational problem $\mathbf{L}[u] = \int L(x, u^{(n)}) d^p x$. Let

$$Q^\alpha(x, u^{(1)}) \equiv U^\alpha(x, u) - \sum_{i=1}^p X^i(x, u) u_i^\alpha, \quad u_i^\alpha = \frac{\partial u^\alpha}{\partial x^i}.$$

Then there exists a p -tuple $\mathbf{J} = (J_1, \dots, J_p)$ such that

$$\mathbf{D} \cdot \mathbf{J} = \sum_{\alpha=1}^q Q^\alpha \mathbb{E}_\alpha(L) \tag{33.27}$$

is a conservation law in characteristic form for the Euler-Lagrange equation $\mathbb{E}_\alpha(L) = 0$.

Proof We use Lemma 33.3.8 in the infinitesimal criterion of the variational symmetry (33.20) to obtain

$$\begin{aligned} 0 &= \text{pr}^{(n)} \mathbf{v}(L) + L \mathbf{D} \cdot \mathbf{X} \\ &= \text{pr}^{(n)} \mathbf{v}_Q(L) + \sum_{i=1}^p X^i D_i L + L \sum_{i=1}^p D_i X^i \\ &= \text{pr}^{(n)} \mathbf{v}_Q(L) + \sum_{i=1}^p D_i(L X^i) = \text{pr}^{(n)} \mathbf{v}_Q(L) + \mathbf{D} \cdot (L \mathbf{X}). \end{aligned} \tag{33.28}$$

Using the definition of $\text{pr}^{(n)}\mathbf{v}_Q$ and the identity

$$(D_j S)T = D_j(ST) - SD_j T,$$

we can commute $D_J = D_{j_1} \cdots D_{j_k}$ past Q^α one factor at a time, each time introducing a divergence. Therefore,

$$\begin{aligned} \text{pr}^{(n)}\mathbf{v}_Q(L) &= \sum_{\alpha, J} D_J Q^\alpha \frac{\partial L}{\partial u_J^\alpha} = \sum_{\alpha, J} Q^\alpha (-D)_J \frac{\partial L}{\partial u_J^\alpha} + \mathbf{D} \cdot \mathbf{A} \\ &= \sum_{\alpha=1}^q Q^\alpha \mathbb{E}_\alpha(L) + \mathbf{D} \cdot \mathbf{A}, \end{aligned}$$

where $\mathbf{A} = (A_1, \dots, A_p)$ is some p -tuple of functions depending on L , the Q^α 's, and their derivatives, whose precise form is not needed here. Combining this with Eq. (33.28), we obtain

$$0 = \sum_{\alpha=1}^q Q^\alpha \mathbb{E}_\alpha(L) + \mathbf{D} \cdot (\mathbf{A} + L\mathbf{X}).$$

Selecting $\mathbf{J} = -(\mathbf{A} + L\mathbf{X})$ proves the theorem. \square

33.4 Application to Classical Field Theory

It is clear from the proof of Noether's theorem that if we are interested in the conserved current, we need to find \mathbf{A} . In general, the expression for \mathbf{A} is very complicated. However, if the variational problem is of first order (which in most cases of physical interest it is), then we can easily find the explicit form of \mathbf{A} , and, consequently the conserved current \mathbf{J} . We leave it for the reader to prove the following:

Corollary 33.4.1 *Let $\mathbf{v} = \sum_{i=1}^p X^i \partial / \partial x^i + \sum_{\alpha=1}^q U^\alpha \partial / \partial u^\alpha$ be the infinitesimal generator of a local 1-parameter group of symmetries G of the first-order variational problem $\mathbf{L}[u] = \int L(x, u^{(1)}) d^p x$. Then⁵*

$$J_i = \sum_{\alpha=1}^q \sum_{j=1}^p X^j u_j^\alpha \frac{\partial L}{\partial u_i^\alpha} - \sum_{\alpha=1}^q U^\alpha \frac{\partial L}{\partial u_i^\alpha} - X^i L, \quad i = 1, \dots, p$$

form the components of a conserved current for the Euler-Lagrange equation $\mathbb{E}_\alpha(L) = 0$.

Historical Notes

Amalie Emmy Noether (1882–1935), generally considered the greatest of all female mathematicians up to her time, was the eldest child of Max Noether, research mathematician and professor at the University of Erlangen, and Ida Amalia Kaufmann. Two of

⁵We have multiplied J_i by a negative sign to conform to physicists' convention.



Amalie Emmy Noether
1882–1935

Emmy's three brothers were also scientists. Alfred, her junior by a year, earned a doctorate in chemistry at Erlangen. Fritz, two and a half years younger, became a distinguished physicist; and his son, Gottfried, became a mathematician.

At first Emmy Noether had planned to be a teacher of English and French. From 1900 to 1902 she studied mathematics and foreign languages at Erlangen. Then in 1903 she started her specialization in mathematics at the University of Göttingen. At both universities she was a nonmatriculated auditor at lectures, since at the turn of the century women could not be admitted as regular students. In 1904 she was permitted to matriculate at the University of Erlangen, which granted her the Ph.D., *summa cum laude*, in 1907. Her sponsor, the algebraist Gordan, strongly influenced her doctoral dissertation on algebraic invariants. Her divergence from Gordan's viewpoint and her progress in the direction of the "new" algebra first began when she was exposed to the ideas of Ernst Fischer, who came to Erlangen in 1911.

In 1915 Hilbert invited Emmy Noether to Göttingen. There she lectured at courses that were given under his name and applied her profound invariant-theoretic knowledge to the resolution of problems that he and Felix Klein were considering. Inspired by Hilbert and Klein's investigation into Einstein's general theory of relativity, Noether wrote her remarkable 1918 paper in which both the concept of *variational symmetry* and its connection with *conservation laws* were set down in complete generality.

Hilbert repeatedly tried to obtain her an appointment as Privatdozent, but the strong prejudice against women prevented her habilitation until 1919. In 1922 she was named a *nichtbeamteter ausserordentlicher Professor* ("unofficial associate professor"), a purely honorary position. Subsequently, a modest salary was provided through a *Lehrauftrag* ("teaching appointment") in algebra. Thus she taught at Göttingen (1922–1933), interrupted only by visiting professorships at Moscow (1928–1929) and at Frankfurt (summer of 1930).

In April 1933 she and other Jewish professors at Göttingen were summarily dismissed. In 1934 Nazi political pressures caused her brother Fritz to resign from his position at Breslau and to take up duties at the research institute in Tomsk, Siberia. Through the efforts of Hermann Weyl, Emmy Noether was offered a visiting professorship at Bryn Mawr College; she departed for the United States in October 1933. Thereafter she lectured and did research at Bryn Mawr and at the Institute for Advanced Studies, Princeton, but those activities were cut short by her sudden death from complications following surgery. Emmy Noether's most important contributions to mathematics were in the area of abstract algebra. One of the traditional postulates of algebra, namely the commutative law of multiplication, was relinquished in the earliest example of a generalized algebraic structure, e.g., in Hamilton's quaternion algebra and also in many of the 1844 Grassmann algebras. From 1927 to 1929 Emmy Noether contributed notably to the theory of representations, the object of which is to provide realizations of noncommutative algebras by means of matrices, or linear transformations. From 1932 to 1934 she was able to probe profoundly into the structure of noncommutative algebras by means of her concept of the *verschränktes* ("cross") product.

Emmy Noether wrote some forty-five research papers and was an inspiration to many future mathematicians. The so-called Noether school included such algebraists as Hasse and W. Schmeidler, with whom she exchanged ideas and whom she converted to her own special point of view. She was particularly influential in the work of B. L. van der Waerden, who continued to promote her ideas after her death and to indicate the many concepts for which he was indebted to her.

Corollary 33.4.1 can be applied to most DEs in physics derivable from a Lagrangian. We are interested in partial DEs studied in classical field theories. The case of ODEs, studied in point mechanics, is relegated to Problem (33.11).

First consider spacetime translation $\mathbf{v}^i = \eta^{ij} \partial_j$, where we have introduced the Lorentz metric η^{ij} to include non-Euclidean cases. In order for \mathbf{v}^i to be an infinitesimal variational symmetry, it has to satisfy Eq. (33.20), which in the case at hand, reduces to $\mathbf{v}^i(L) = 0$, or $\partial_i L = 0$.

Box 33.4.2 *In order for a variational problem to be invariant under spacetime translations, its Lagrangian must not depend explicitly on the coordinates.*

If spacetime translation happens to be a symmetry, then $X^i \rightarrow \eta^{ij}$, and the (double-indexed) conserved current, derived from Corollary 33.4.1, takes the form

$$T^{ij} = \sum_{\alpha=1}^q \frac{\partial u^\alpha}{\partial x_j} \frac{\partial L}{\partial u_i^\alpha} - \eta^{ij} L.$$

Using Greek indices to describe space-time coordinates, and Latin indices to label the components of \mathbb{R}^q , we write energy momentum current density

$$T^{\mu\nu} = \sum_{j=1}^q \frac{\partial \phi^j}{\partial x_\mu} \frac{\partial L}{\partial \phi_\nu^j} - \eta^{\mu\nu} L \equiv \sum_{j=1}^q \eta^{\mu\sigma} \frac{\partial \phi^j}{\partial x^\sigma} \frac{\partial L}{\partial \phi_\nu^j} - \eta^{\mu\nu} L, \quad (33.29)$$

where we changed the dependent variable u to ϕ to adhere to the notation used in the physics literature. Recall that $\phi_\nu^j \equiv \partial \phi^j / \partial x^\nu$. $T^{\mu\nu}$ is called the **energy momentum current density**.

The quantity $T^{\mu\nu}$, having a vanishing divergence, is really a density, just as the continuity equation (vanishing of the divergence) for the electric charge involves the electric charge and current densities. In the electric case, we find the charge by integrating the charge density, the zeroth component of the electric 4-current density. Similarly, we find the “charge” associated with $T^{\mu\nu}$ by integrating its zeroth component. This yields the energy momentum 4 vector:

$$P^\nu = \int_V T^{0\nu} d^3x.$$

We note that

$$\begin{aligned} \frac{dP^\nu}{dt} &= \frac{d}{dt} \int_V T^{0\nu} d^3x = \int_V \frac{\partial T^{0\nu}}{\partial t} d^3x \\ &= - \int_V \sum_{i=1}^3 \frac{\partial T^{i\nu}}{\partial x^i} d^3x = - \int_S \sum_{i=1}^3 T^{i\nu} da_i, \end{aligned}$$

where we have used the three-dimensional divergence theorem. By taking S to be infinite, and assuming that $T^{i\nu} \rightarrow 0$ at infinity (faster than the element of area da_i diverges), we obtain $dP^\nu/dt = 0$, the conservation of the 4-momentum.

Example 33.4.3 A relativistic scalar field of mass m is a 1-component field satisfying the Klein–Gordon equation, which is, as the reader may check, the Euler-Lagrange equation of

$$\mathbf{L}[\phi] = \int L(\phi, \phi_\mu) d^4x \equiv \int \frac{1}{2} [\eta^{\mu\nu} \partial_\mu \phi \partial_\nu \phi - m^2 \phi^2] d^4x.$$

The energy momentum current for the scalar field is found to be

$$T^{\mu\nu} = \partial^\mu \phi \partial^\nu \phi - \eta^{\mu\nu} L, \quad \partial^\mu \phi \equiv \eta^{\mu\nu} \frac{\partial \phi}{\partial x^\nu}.$$

Note that $T^{\mu\nu}$ is symmetric under interchange of its indices. This is a desired feature of the energy momentum current that holds for the scalar field but is not satisfied in general, as Eq. (33.29) indicates. The reader is urged to show directly that $\partial_\mu T^{\mu\nu} = 0 = \partial_\nu T^{\mu\nu}$, i.e., that energy momentum is conserved.

To go beyond translation, we consider classical (nonquantized) fields⁶ $\{\phi^j\}_{j=1}^{n_\alpha}$, which, as is the case in most physical situations, transform among themselves as the rows of the α th irreducible representation of a Lie group G that acts on the independent variables. Under these circumstances, the generators of the symmetry are given by Eq. (30.11):

$$\mathfrak{D}_{ij}(\boldsymbol{\xi}) = \mathfrak{T}_{ij}^{(\alpha)}(\boldsymbol{\xi}) \phi^k(\mathbf{x}) \frac{\partial}{\partial \phi^k} + \delta_{ij} X^\nu(\mathbf{x}; \boldsymbol{\xi}) \frac{\partial}{\partial x^\nu}, \quad (33.30)$$

where ν labels the independent variables. Corollary 33.4.1 now gives the conserved current as

$$J_{ij}^\mu = \left\{ X^\mu(\mathbf{x}; \boldsymbol{\xi}) \phi_\nu^k(\mathbf{x}) \frac{\partial L}{\partial \phi_\nu^k} - X^\mu(\mathbf{x}; \boldsymbol{\xi}) L \right\} \delta_{ij} - \phi^k(\mathbf{x}) \frac{\partial L}{\partial \phi_\mu^k} \mathfrak{T}_{ij}^{(\alpha)}(\boldsymbol{\xi}),$$

where summation over repeated indices is understood with $1 \leq k \leq n_\alpha$ and $1 \leq \nu \leq p$. We can rewrite this equation in the form

$$\mathbf{J}^\mu = \left\{ X^\mu(\mathbf{x}; \boldsymbol{\xi}) \phi_\nu^k(\mathbf{x}) \frac{\partial L}{\partial \phi_\nu^k} - X^\mu(\mathbf{x}; \boldsymbol{\xi}) L \right\} \mathbf{1} - \phi^k(\mathbf{x}) \frac{\partial L}{\partial \phi_\mu^k} \boldsymbol{\mathfrak{T}}^{(\alpha)}(\boldsymbol{\xi}), \quad (33.31)$$

where \mathbf{J}^μ and $\boldsymbol{\mathfrak{T}}^{(\alpha)}(\boldsymbol{\xi})$ are $n_\alpha \times n_\alpha$ matrices whose elements are J_{ij}^μ and $\mathfrak{T}_{ij}^{(\alpha)}(\boldsymbol{\xi})$, respectively, and $\mathbf{1}$ is the unit matrix of the same dimension.

We note that the conserved current has a coordinate part (the term that includes X^μ and multiplies the unit matrix), and an ‘‘intrinsic’’ part (the term with no X^μ) represented by the term involving $\boldsymbol{\mathfrak{T}}^{(\alpha)}(\boldsymbol{\xi})$. If the field has only one component (a scalar field), then $\boldsymbol{\mathfrak{T}}^{(\alpha)}(\boldsymbol{\xi}) = 0$, and only the coordinate part contributes to the current.

The current \mathbf{J}^μ acquires an extra index when a *component* of $\boldsymbol{\xi}$ is chosen. As a concrete example, consider the case where G is the rotation group in \mathbb{R}^p . Then a typical component of $\boldsymbol{\xi}$ will be $\xi^{\rho\sigma}$, corresponding to a rotation in the $\rho\sigma$ -plane, and the current will be written as $\mathbf{J}^{\mu;\rho\sigma}$. These extra indices are also reflected in X^μ , as that too is a function of $\boldsymbol{\xi}$:

$$X^\mu(\mathbf{x}; \xi^{\rho\sigma}) \frac{\partial}{\partial x^\mu} = x^\rho \partial_\sigma - x^\sigma \partial_\rho \quad \Rightarrow \quad X^\mu(\mathbf{x}; \xi^{\rho\sigma}) = x^\rho \delta^{\mu\sigma} - x^\sigma \delta^{\mu\rho}.$$

⁶The reader notes that the superscript α , which labeled components of the independent variable u , is now the label of the irreducible representation. The components of the dependent variable (now denoted by ϕ) are labeled by j .

The volume integral of $\mathbf{J}^{0;\rho\sigma}$ will give the components of angular momentum. When integrated, the term multiplying $\mathbf{1}$ becomes the **orbital angular momentum**, and the remaining term gives the **intrinsic spin**. The conservation of $\mathbf{J}^{\mu;\rho\sigma}$ is the statement of the conservation of *total* angular momentum. The label α denotes various representations of the rotation group. If $p = 3$, then α is simply the value of the spin. For example, the spin- $\frac{1}{2}$ representation corresponds to $\alpha = \frac{1}{2}$, and

orbital angular momentum and intrinsic spin

$$\mathfrak{T}^{(1/2)}(\xi) = \frac{1}{2}(\sigma^1, \sigma^2, \sigma^3), \quad \text{or} \quad \mathfrak{T}^{(1/2)}(\xi^a) = \frac{1}{2}\sigma^a, \quad a = 1, 2, 3,$$

with a labeling the three different “directions” of rotation.⁷ If the field is a scalar, $\mathfrak{T}^{(\alpha)}(\xi) = 0$, and the field has only an orbital angular momentum.

33.5 Problems

33.1 Show that the derivative of a linear map from one Hilbert space to another is the map itself.

33.2 Show that a complex function $f : \mathbb{C} \supset \Omega \rightarrow \mathbb{C}$ considered as a map $f : \mathbb{R}^2 \supset \Omega \rightarrow \mathbb{R}^2$ is differentiable iff it satisfies the Cauchy-Riemann conditions. Hint: Consider the Jacobian matrix of f , and note that a linear complex map $\mathbf{T} : \mathbb{C} \rightarrow \mathbb{C}$ is necessarily of the form $\mathbf{T}(z) = \lambda z$ for some constant $\lambda \in \mathbb{C}$.

33.3 Show that

$$\frac{\delta \mathbf{E}_{\mathbf{y},i}[u]}{\delta u}(\mathbf{x}) = -\partial_i \delta(\mathbf{x} - \mathbf{y}).$$

33.4 Show that the first functional derivative of $\mathbf{L}[u] \equiv \int_{x_1}^{x_2} \sqrt{1 + u_x^2} dx$, obtained using Eq. (33.9), is $\mathbb{E}(L)$.

33.5 Show that for the proper time of special relativity

$$\frac{\delta \mathbf{L}[x]}{\delta x(s)} = \frac{x_{ss}}{(1 - x_s^2)^{3/2}}.$$

Use this to show that the contribution of the second variational derivative to the Taylor expansion of the functional is always negative.

33.6 Show that the first prolongation of the Lorentz generator $\mathbf{v} = u\partial_x + x\partial_u$ is

$$\text{pr}^{(1)}\mathbf{v} = \mathbf{v} + (1 - u_x^2)\frac{\partial}{\partial u_x}.$$

⁷Only in three dimensions can one label rotations with a single index. This is because each coordinate plane has a unique direction (by the use of the right-hand rule) perpendicular to it that can be identified as the direction of rotation.

33.7 Verify that rotation in the xu -plane is a symmetry of the arc-length variational problem (see Example 33.1.13).

33.8 Show that \mathbf{v}_4 , \mathbf{v}_6 , and \mathbf{v}_7 of Table 32.3 are variational symmetries of Eq. (33.21), but \mathbf{v}_5 , \mathbf{v}_8 , \mathbf{v}_9 , and \mathbf{v}_{10} are not. Find the constant c (if it exists) such that $\mathbf{v}_5 + cu\partial_u$ is a variational symmetry. Show that no linear combination of inversions produces a symmetry.

Kepler problem **33.9** The two-dimensional **Kepler problem** (for a unit point mass) starts with the functional

$$\mathbf{L} = \int \left[\frac{1}{2}(x_t^2 + y_t^2) - V(r) \right] dt, \quad r = \sqrt{x^2 + y^2}.$$

- Show that \mathbf{L} is invariant under t translation and rotation in the xy -plane.
- Find the generators of t translation and rotation in polar coordinates and conclude that r is the best choice for the *independent* variable.
- Rewrite \mathbf{L} in polar coordinates and show that it is independent of t and θ .
- Write the Euler-Lagrange equations and integrate them to get θ as an integral over r .

33.10 Prove Corollary 33.4.1.

33.11 Consider a system of N particles whose total kinetic energy K and potential energy U are given by

$$K(\dot{\mathbf{x}}) = \frac{1}{2} \sum_{\alpha=1}^N m_{\alpha} |\dot{\mathbf{x}}^{\alpha}|^2, \quad U(t, \mathbf{x}) = \sum_{\alpha \neq \beta} k_{\alpha\beta} |\mathbf{x}^{\alpha} - \mathbf{x}^{\beta}|^{-1},$$

where $\mathbf{x}^{\alpha} = (x^{\alpha}, y^{\alpha}, z^{\alpha})$ is the position of the α th particle. The variational problem is of the form

$$\mathbf{L}[\mathbf{x}] = \int_{-\infty}^{\infty} L(t, \mathbf{x}, \dot{\mathbf{x}}) dt = \int_{-\infty}^{\infty} [K(\dot{\mathbf{x}}) - U(t, \mathbf{x})] dt.$$

- Show that the Euler-Lagrange equations are identical to Newton's second law of motion.
- Write the infinitesimal criterion for the vector field

$$\mathbf{v} = \tau(t, \mathbf{x}) \frac{\partial}{\partial t} + \sum_{\alpha} \left[\xi^{\alpha}(t, \mathbf{x}) \frac{\partial}{\partial x^{\alpha}} + \eta^{\alpha}(t, \mathbf{x}) \frac{\partial}{\partial y^{\alpha}} + \zeta^{\alpha}(t, \mathbf{x}) \frac{\partial}{\partial z^{\alpha}} \right]$$

to be the generator of a 1-parameter group of variational symmetries of \mathbf{L} .

- (c) Show that the conserved “current” derived from Corollary 33.4.1 is

$$T = \sum_{\alpha=1}^N m_{\alpha} (\xi^{\alpha} \dot{x}^{\alpha} + \eta^{\alpha} \dot{y}^{\alpha} + \zeta^{\alpha} \dot{z}^{\alpha}) - \tau E,$$

where $E = K + U$ is the total energy of the system.

- (d) Find the conditions on U such that (i) time translation, (ii) space translations, and (iii) rotations become symmetries of \mathbf{L} . In each case, compute the corresponding conserved quantity.

33.12 Show that the Euler-Lagrange equation of

$$\mathbf{L}[\phi] = \int L(\phi, \phi_{\mu}) d^4x \equiv \int \frac{1}{2} [\eta^{\mu\nu} \partial_{\mu} \phi \partial_{\nu} \phi - m^2 \phi^2] d^4x$$

is the Klein–Gordon equation. Verify that $T^{\mu\nu} = \partial^{\mu} \phi \partial^{\nu} \phi - \eta^{\mu\nu} L$ are the currents associated with the invariance under translations. Show directly that $T^{\mu\nu}$ is conserved.

Part X
Fiber Bundles

The elegance of the geometrical expression of physical ideas has attracted much attention ever since Einstein proposed his geometrical theory of gravity in 1916. Such an expression was, however, confined to the general theory of relativity until the 1970s when the language of geometry was found to be most suitable, not only for gravity, but also for the other three fundamental forces of nature. Geometry, in the form of gauge field theories of electroweak and strong interactions, has been successful not only in creating a model—the so-called **standard model**—that explains all experimental results to remarkable accuracy, but also in providing a common language for describing all fundamental forces of nature, and with that a hope for unifying these forces into a single all-embracing force. This hope is encouraged by the successful unification of electromagnetism with the weak nuclear force through the medium of geometry and gauge field theory.

The word “geometry” is normally used in the mathematics literature for a manifold on which a “machine” is defined with the property that it gives a number when two vectors are fed into it. Symplectic geometry’s machine was a nondegenerate 2-form. Riemannian (or pseudo-Riemannian or semi-Riemannian) geometry has a symmetric bilinear form (metric, inner product). Both of these geometries are important: Symplectic geometry is the natural setting for Hamiltonian dynamics, and (pseudo- or semi-) Riemannian geometry is the basis of the general theory of relativity.

The most elegant way of studying geometry, which very naturally encompasses the (pseudo-)Riemannian geometry of general relativity and the gauge theory of the fundamental interactions of physics, is the language of the fiber bundles, which we set out to do in this chapter.

34.1 Principal Fiber Bundles

In Sect. 28.4, we defined the tangent bundle $T(M)$ as the union of the tangent spaces at all points of a manifold M . It can be shown that $T(M)$ is a manifold, and that there is a differentiable surjective map $\pi : T(M) \rightarrow M$, sending the tangent space $T_x(M)$ at $x \in M$ to x .¹ The inverse of this map at

¹For ease of notation, we have changed $\mathcal{T}_P(M)$ of Definition 28.4.1 to $T_x(M)$.

$x, \pi^{-1}(x)$, is the collection of all vectors at x . The notion of tangent *bundle* and the corresponding map π can be generalized to the extremely fruitful notion of principal fiber bundle.

principal fiber bundle **Definition 34.1.1** A **principal fiber bundle** (PFB) over a manifold M with Lie group G is a manifold P , called the **total space** or the **bundle space**, and an action of G on P satisfying the following conditions:

- (1) G acts freely on P on the right: $R_g(p) \equiv p \cdot g \equiv pg \in P$.
- (2) M is the space P/G of the orbits of G in P and the canonical map $\pi : P \rightarrow P/G$ is differentiable.
- local trivialization (3) P is **locally trivial**, i.e., for every point $x \in M$, there is a neighborhood U containing x and a diffeomorphism $T_u : \pi^{-1}(U) \rightarrow U \times G$ of the form $T_u(p) = (\pi(p), s_u(p))$ where $s_u : \pi^{-1}(U) \rightarrow G$ has the property $s_u(pg) = s_u(p)g$ for all $g \in G$ and $p \in \pi^{-1}(U)$. The map T_u is called a **local trivialization** (*LT*).

base space; structure group; projection; fiber A principal fiber bundle will be denoted by $P(M, G, \pi)$, or $P(M, G)$, or even just P . M is called the **base space**, G the **structure group**, and π the **projection** of the PFB. For each $x \in M$, $\pi^{-1}(x)$ is a submanifold of P , called the **fiber** over x . If $x = \pi(p)$, then $\pi^{-1}(x)$ is just the orbit of G at p . By Theorem 29.1.7, every fiber is diffeomorphic to G . There is no natural group structure on $\pi^{-1}(x)$. So, although fibers can be thought of as copies of G , they are so *only as manifolds*.

Remark 34.1.1 Just as a fiber sprouts from a single point of the earth (a spherical 2-manifold), so does a fiber $\pi^{-1}(x)$ sprout out of a single point x of the manifold M . And just as you can collect a bunch of fibers and make a *bundle* out of them, so can you collect a bunch of $\pi^{-1}(x)$'s and make $P = \bigcup_x \pi^{-1}(x)$. Furthermore, fibers sprout vertically from the ground. Similarly, in a sense to be elaborated in our discussion of connections, $\pi^{-1}(x)$ are "vertical" manifolds, while M is "horizontal."

trivial bundle **Example 34.1.2** Let M be any manifold and G any Lie group. Let $P = M \times G$ and let G act on P on the right by the rule: $(x, g)g' = (x, gg')$. We note that the action is free because

$$\begin{aligned} (x, g)g' = (x, g) &\iff (x, gg') = (x, g) &\iff gg' = g \\ &&\iff g' = e. \end{aligned}$$

Two points (x, g) and (x', g') belong to the same orbit iff there is $h \in G$ such that $(x, g)h = (x', g')$. This happens iff $x' = x$ and $gh = g'$. It follows that for any g , (x, g) belongs to the orbit at (x, e) . Therefore, $[(x, g)] = [(x, e)]$. This gives a natural identification of P/G with M . For trivialization, let the neighborhood U of any point be M and let $s_u(x, g) = g$. This choice makes P *globally* trivial, thus the name **trivial** for such a bundle.

Definition 34.1.3 A **homomorphism** of a principal fiber bundle $P'(M', G')$ into another $P(M, G)$ is a pair (f, f_G) of maps $f : P' \rightarrow P$ and $f_G : G' \rightarrow G$ with f_G a group homomorphism such that $f(p'g') = f(p')f_G(g')$ for all $p' \in P'$ and $g' \in G'$. Every bundle homomorphism induces a map $f_M : M' \rightarrow M$. If f is bijective and f_G a group isomorphism, then f_M is a diffeomorphism and (f, f_G) is called an **isomorphism** of $P'(M', G')$ onto $P(M, G)$. An isomorphism of $P(M, G)$ onto itself in which $f_G = \text{id}_G$ is called an **automorphism** of P .

homomorphism,
isomorphism, and
automorphism of PFBs

Requirement (3) in Definition 34.1.1 situates $x \in M$ in the (sub)bundle $\pi^{-1}(U)$ which, through the diffeomorphism T_u , can be identified as the trivial bundle $U \times G$. The natural right action of G on the trivial bundle $U \times G$ should therefore be identified with its action on $\pi^{-1}(U)$. On the one hand,

$$T_u(p) = (\pi(p), s_u(p)), \quad T_u(pg) = (\pi(pg), s_u(pg)) = (\pi(p), s_u(pg)),$$

where the last equality follows because p and pg both belong to the orbit at p . On the other hand,

$$(\pi(p), s_u(p))g = (\pi(p), s_u(p)g) \quad \text{for the trivial bundle } U \times G.$$

So if the action of G on $U \times G$ is to be identified with its action on $\pi^{-1}(U)$, we must have $s_u(pg) = s_u(p)g$. That is why this equality was demanded in Definition 34.1.1. We summarize this by saying that T_u respects the action of G .

A local trivialization
respects the action of
structure group.

Now let $T_u : \pi^{-1}(U) \rightarrow U \times G$ and $T_v : \pi^{-1}(V) \rightarrow V \times G$ be two LTs. If $x \in U \cap V$ and $\pi(p) = x$, then $T_u(p) = (\pi(p), s_u(p))$, and $T_v(p) = (\pi(p), s_v(p))$. Since $s_u(p), s_v(p) \in G$, there must exist $g \in G$ such that $gs_v(p) = s_u(p)$. In fact, $g = s_u(p)(s_v(p))^{-1}$. What is interesting about g is that it can be defined on M .

transition functions for a
PFB

Definition 34.1.4 Let $T_u : \pi^{-1}(U) \rightarrow U \times G$ and $T_v : \pi^{-1}(V) \rightarrow V \times G$ be two LTs of a PFB $P(M, G, \pi)$. The **transition function** from T_u to T_v is the map $g_{uv} : U \cap V \rightarrow G$, given by $g_{uv}(x) = s_u(p)(s_v(p))^{-1}$.

For this definition to make sense, $g_{uv}(x)$ must be independent of $p \in \pi^{-1}(x)$. Indeed, we have

Proposition 34.1.5 The transition function g_{uv} from the local trivialization T_u to the local trivialization T_v is independent of the choice of $p \in \pi^{-1}(x)$. Furthermore,

- (1) $g_{uu}(x) = e \quad \forall x \in U$;
- (2) $g_{uv}(x) = g_{vu}(x)^{-1} \quad \forall x \in U \cap V$;
- (3) $g_{uv}(x) = g_{uw}(x)g_{wv}(x) \quad \forall x \in U \cap V \cap W$.

Proof Let $p' \in \pi^{-1}(x)$ be a different point from p . Since p' is in the same orbit as p , we must have $p' = pg$ for some $g \in G$. Then

$$\begin{aligned} s_u(p')(s_u(p'))^{-1} &= s_u(pg)(s_u(pg))^{-1} = s_u(p)g(s_u(p)g)^{-1} \\ &= s_u(p)gg^{-1}(s_u(p))^{-1} = s_u(p)(s_u(p))^{-1} \end{aligned}$$

Thus g_{uv} is well defined. The other parts of the proposition are trivial. \square

Consider a manifold M . Let $\{U_\alpha\}$ be an open cover of M , i.e., open sets such that $M = \bigcup_\alpha U_\alpha$. Let G be a Lie group. Construct the set of trivial PFBs $P_\alpha = U_\alpha \times G$. Connect all pairs P_α and P_β by transition functions $g_{\alpha\beta} : U_\alpha \cap U_\beta \rightarrow G$ satisfying (1)–(3) of Proposition 34.1.5. This process constructs a PFB with transition functions $g_{\alpha\beta}$. Therefore, a PFB is *defined* by its transition functions. In fact, it is only the transition functions that determine the bundle. Any PFB can be broken down into a collection $\{U_\alpha \times G\}$ of trivial bundles. It is *how* these trivial bundles are “glued together” via the transition functions that distinguishes between different PFBs.

Given a PFB $P(M, G)$ and a subgroup G' of G , it may be possible to find some covering $\{U_\alpha\}$ of M and transition functions $g_{\alpha\beta}$ which take values in G' . The new covering and transition functions define a new PFB $P'(M, G')$. Then we say that the PFB $P(M, G)$ is **reducible** to $P'(M, G')$. We also say that the structure group G of $P(M, G)$ is reducible to G' if $P(M, G)$ is reducible to $P'(M, G')$.

Example 34.1.6 Let’s reconsider the trivial bundle $M \times G$. What is the most general *local* trivialization of this bundle? Let $x \in U_\alpha$ if $p = (x, g)$, then $T_\alpha(p) = (x, g')$ for some $g' \in G$, and $s_\alpha(p) = s_\alpha(x, g) = g'$. This means that s_α affects only g , and therefore, can be reduced to a function $f_\alpha : G \rightarrow G$ having the property that $f_\alpha(gg') = f_\alpha(g)g'$. With $g = e$, this gives $f_\alpha(g') = f_\alpha(e)g'$. Thus, f_α is simply left multiplication by $h_\alpha \equiv f_\alpha(e)$, where h_α may depend on U_α . Hence, the most general LT for the trivial bundle $M \times G$ is

$$T_\alpha(p) = (x, h_\alpha g) \equiv (x, s_\alpha(p)) \quad \text{or} \quad s_\alpha((x, g)) = h_\alpha g$$

So, the transition functions are of the form $g_{\alpha\beta}(x) = h_\alpha h_\beta^{-1}$, and can easily be shown to satisfy the three conditions of Proposition 34.1.5.

Can the trivial bundle be reduced? Are there a covering $\{U_\alpha\}$ and transition functions $g_{\alpha\beta}$ which take values in a subgroup of G ? In fact, G can be drastically reduced! In the above discussion let $h_\alpha = h$ for all α . Then, $g_{\alpha\beta}(x) = e$ for all $x \in U_\alpha \cap U_\beta$ (and therefore for all $x \in M$).

The converse of the last statement of the example above is also true:

Proposition 34.1.7 Any PFB whose structure group can be reduced to the identity of the group is isomorphic to the trivial PFB.

Definition 34.1.8 A **local section** (or *local cross section*) of a principal fiber bundle $P(M, G, \pi)$ on an open set $U \subset M$ is a map $\sigma_u : U \rightarrow P$ such that $\pi \circ \sigma_u = \text{id}_U$. If $U = M$, then $\sigma_u \equiv \sigma$ is called a **global section** or simply a **section** on M .

local section and section

Proposition 34.1.9 *There is a natural 1-1 correspondence between the set of local trivializations and the set of local sections. In particular, if $P(M, G, \pi)$ has a (global) section, then $P(M, G, \pi) = M \times G$, the trivial bundle.*

Proof For each local trivialization T_u let $\sigma_u = T_u^{-1}|_{U \times \{e\}} : U \cong U \times \{e\} \rightarrow P$. Conversely, for each σ_u , define $S_u : U \times G \rightarrow \pi^{-1}(U)$ by $S_u(x, g) = \sigma_u(x)g$. Then it can be shown that S_u is a bijection and $T_u = S_u^{-1}$ is a local trivialization. \square

Let σ_u be a local section on U and σ_v on V . If $x \in U \cap V$, then $\sigma_u(x)$ and $\sigma_v(x)$ both belong to $\pi^{-1}(x)$. Hence, there must be a $g \in G$ such that $\sigma_v(x) = \sigma_u(x)g$. We want to find this g . From the definition of T_u , we have $T_u^{-1}(x, e) = p_0$ for some $p_0 \in P$. Thus, $T_u(p_0) = (x, s_u(p_0)) = (x, e)$ implies that $s_u(p_0) = e$. But $T_u^{-1}(x, e) = \sigma_u(x)$. Therefore, we have $\sigma_u(x) = p_0$ with $s_u(p_0) = e$. Similarly, $\sigma_v(x) = p_1$ with $s_v(p_1) = e$. Let $p_1 = p_0g$. Then $e = s_v(p_1) = s_v(p_0g) = s_v(p_0)g$, or $g = s_v(p_0)^{-1}$. We thus get $\sigma_v(x) = p_0s_v(p_0)^{-1}$ or $\sigma_v(x)s_v(p_0) = p_0$. Multiplying both sides by an arbitrary g , we get

$$\begin{aligned} \sigma_v(x)s_v(p_0)g &= p_0g \quad \text{or} \quad \sigma_v(x)s_v(p_0g) = p_0g \quad \text{or} \\ \sigma_v(x)s_v(p) &= p \quad \forall p \in P. \end{aligned}$$

An identical reasoning gives $\sigma_u(x)s_u(p) = p$. Therefore, $\sigma_v(x)s_v(p) = \sigma_u(x)s_u(p)$, or $\sigma_v(x) = \sigma_u(x)s_u(p)s_v(p)^{-1}$. Thus,

$$\sigma_v(x) = \sigma_u(x)g_{uv}(x) \tag{34.1}$$

where g_{uv} is the transition function from T_u to T_v .

Example 34.1.10 (The bundle $G(G/H, H)$) Let G be a Lie group and H one of its Lie subgroups. Let H act on G on the right by right multiplication. Let G/H be the factor group of this action and $\pi : G \rightarrow G/H$, the natural projection. It is shown in Lie group theory that such a construction has local trivializations. Then with G as the total space, $M = G/H$ as the base space, and $\pi : G \rightarrow G/H$ as the projection, $G(G/H, H, \pi)$ becomes a principal fiber bundle.

Example 34.1.11 (Bundle of linear frames) Let M be an n -manifold. A **linear frame** p at $x \in M$ is an ordered basis $(\mathbf{X}_1, \mathbf{X}_2, \dots, \mathbf{X}_n)$ of the tangent space $T_x(M)$. Let $L_x(M)$ be the set of all linear frames at x and $L(M)$ the

bundle of linear frames

set of all $L_x(M)$ for all $x \in M$. Let $\pi : L(M) \rightarrow M$ be the map that sends $L_x(M)$ to x . If $A \in GL(n, \mathbb{R})$ is a matrix with components a_j^i , then the action of $GL(n, \mathbb{R})$ on $L(M)$ on the right is written in matrix form as

$$(\mathbf{X}_1 \ \mathbf{X}_2 \ \dots \ \mathbf{X}_n) \begin{pmatrix} a_1^1 & a_2^1 & \dots & a_n^1 \\ a_1^2 & a_2^2 & \dots & a_n^2 \\ \vdots & \vdots & & \vdots \\ a_1^n & a_2^n & \dots & a_n^n \end{pmatrix} \equiv (\mathbf{Y}_1 \ \mathbf{Y}_2 \ \dots \ \mathbf{Y}_n).$$

In “component” form, this can be written as $\mathbf{Y}_i = a_i^j \mathbf{X}_j$ (with summation convention in place). Since A is invertible, $(\mathbf{Y}_1, \mathbf{Y}_2, \dots, \mathbf{Y}_n) \in L(M)$. So, indeed $GL(n, \mathbb{R})$ acts on $L(M)$ on the right. It is easy to show that the action is free (Problem 34.4). Furthermore, if $p, q \in \pi^{-1}(x) \equiv L_x(M)$, i.e., if p and q are two (ordered) bases of $T_x(M)$, then there must exist an invertible matrix A such that $q = pA$. Therefore, $\pi^{-1}(x)$ is indeed the orbit of $GL(n, \mathbb{R})$ at p . This shows (1) and (2) of Definition 34.1.1. Foregoing the rather technical details of (3), we find that $L(M)(M, GL(n, \mathbb{R}))$ is indeed a principal fiber bundle.

Definition 34.1.12 The PFB described in Example 34.1.11 is called the **bundle of linear frames** and denoted by $L(M)(M, GL(n, \mathbb{R}))$, or simply $L(M)$.

34.1.1 Associated Bundles

associated bundle and its standard fiber and structure group

Let $P(M, G)$ be a PFB and F a manifold on which G acts on the left: $G \times F \ni (g, \xi) \mapsto g\xi \in F$. On the product manifold $P \times F$ let G act on the right by the rule $R_g(p, \xi) \equiv (p, \xi)g \equiv (pg, g^{-1}\xi)$. Denote the quotient space of this action by $P \times_G F$, and let $E \equiv P \times_G F$. For $[[p, \xi]] \in E$ let $\pi_E([[p, \xi]]) = \pi(p) = x \in M$. Then π_E is a projection of E onto M . Define $\phi_u : \pi_E^{-1}(U) \rightarrow U \times F$ by $\phi_u([[p, \xi]]) = (\pi(p), s_u(p)\xi)$, where $s_u : P \rightarrow G$ is as defined in the local trivialization of $P(M, G)$. One can show that ϕ_u is a diffeomorphism (Problem 34.5) and that E is a fiber bundle.

Definition 34.1.13 The fiber bundle constructed above is called the fiber bundle over the base M with **standard fiber** F and **structure group** G which is **associated** with the principal fiber bundle $P(M, G)$. E is more elaborately denoted by $E(M, F, G, P)$. The **fiber over** x in E , $\pi_E^{-1}(x)$ is denoted by F_x .

The diffeomorphism ϕ_u , when restricted to the fiber over x , is denoted by ϕ_x . It is a diffeomorphism: $\phi_x : \pi_E^{-1}(x) \rightarrow \{x\} \times F \cong F$ by $\phi_x([[p, \xi]]) = s_u(p)\xi$. Note that this map is determined entirely by p . The inverse of this

mapping, also determined entirely by p , can be thought of as a map $p : F \rightarrow F_x$, given by $p(\xi) \equiv p\xi = \llbracket p, \xi \rrbracket$. It can easily be shown that this map satisfies

$$(pg)\xi = p(g\xi) \quad \text{for } p \in P, \quad g \in G, \quad \xi \in F. \quad (34.2)$$

Theorem 34.1.14 *Let $P(M, G)$ be a principal fiber bundle with the associated bundle $E(M, F, G, P)$. Then each $p \in P$ can be considered as a diffeomorphic map $p : F \rightarrow F_x$ satisfying (34.2).*

Consider two fibers F_x and F_y . They are diffeomorphic, because each is diffeomorphic to F . In fact if $p : E \rightarrow F_x$ and $q : E \rightarrow F_y$, then $q \circ p^{-1} : F_x \rightarrow F_y$ is called an **isomorphism** of F_y and F_x . For $x = y$, $q \circ p^{-1}$ becomes an **automorphism** of F_x . Moreover, since $\pi(q) = x = \pi(p)$, we must have $q = pg$ for some $g \in G$. Therefore, any automorphism of F_x is of the form $p \circ g \circ p^{-1}$.

Proposition 34.1.15 *The group of automorphisms of F_x is isomorphic with the structure group G .*

Example 34.1.16 The bundle of linear frames consists of fibers which include all ordered bases of $T_x(M)$ and a right action by $GL(n, \mathbb{R})$, which is the group of invertible linear transformation of \mathbb{R}^n . For every ordered basis $p = (\mathbf{X}_1, \mathbf{X}_2, \dots, \mathbf{X}_n) \in L(M)$, let $p(\hat{\mathbf{e}}_i) = \mathbf{X}_i$, where $\{\hat{\mathbf{e}}_i\}_{i=1}^n$ is the standard basis of \mathbb{R}^n . This then defines a map $p : \mathbb{R}^n \rightarrow T_x(M)$. All this, in conjunction with Theorem 34.1.14, leads to the conclusion that $E(M, \mathbb{R}^n, GL(n, \mathbb{R}), L(M))$ is the bundle associated with the bundle of linear frames with standard fiber \mathbb{R}^n , and that $\pi_E^{-1}(x) = T_x(M)$. But Definition 28.4.1, and the discussion at the very beginning of this chapter, indicate that $T_x(M)$ is the fiber over x of the tangent bundle $T(M)$. We also note that the right action $p \mapsto pA$ of $GL(n, \mathbb{R})$ on $L(M)$ can be interpreted as the composite map $p \circ A$:

$$\mathbb{R}^n \xrightarrow{A} \mathbb{R}^n \xrightarrow{p} T_x(M).$$

All this discussion is summarized in

Box 34.1.17 *The tangent bundle $T(M)$ is associated with the bundle of linear frames $L(M)$ with standard fiber \mathbb{R}^n . The right action $p \mapsto pA$ of $GL(n, \mathbb{R})$ on $L(M)$ can be interpreted as $\mathbb{R}^n \xrightarrow{A} \mathbb{R}^n \xrightarrow{p} T_x(M)$, the composite map $p \circ A$.*

Example 34.1.18 Let $\mathcal{T}_s^r(\mathbb{R}^n)$ be the set of tensors of type (r, s) over the vector space \mathbb{R}^n . The action of $GL(n, \mathbb{R})$ on \mathbb{R}^n can be extended to an action on $\mathcal{T}_s^r(\mathbb{R}^n)$ by acting on each of the r vectors and s dual vectors separately.

Tensor fields as sections of bundles associated to $L(M)$

With $\mathcal{J}_s^r(\mathbb{R}^n)$ as the standard fiber, we obtain the tensor bundle $T_s^r(M)$ of type (r, s) over M which is associated with $L(M)$. A tensor field of type (r, s) is a section of this bundle: $\mathbf{T}_s^r : M \rightarrow T_s^r(M)$.

34.2 Connections in a PFB

A principal fiber bundle can be thought of (locally, at least) as a continuous collection of fibers, each fiber located at $x \in U \subset M$. The points of each fiber are naturally connected through the action of G . In fact, given a point of the fiber, we can construct the entire fiber by applying all $g \in G$ to that point. This is by construction and the fact that G acts freely on each fiber. Because each fiber is an orbit of G , and because G acts freely on the fiber, each fiber is diffeomorphic to G . However, there is no natural diffeomorphism connecting one fiber to its neighbor. Such a connection requires an extra structure on the principal fiber bundle, not surprisingly called connection.

fundamental vector field

Given a principal fiber bundle $P(M, G)$, the action of G on P induces a vector field on P for each $A \in \mathfrak{g}$ (see Definition 29.1.30). In fiber bundle theory, it is common to denote this vector field by A^* and call it the **fundamental vector field** corresponding to A . With $\gamma_A(t) \equiv \exp(At)$ the integral curve of A , the fundamental vector field at any point $p \in P$ is defined as

$$A_p^* = \left. \frac{d}{dt}(p\gamma_A(t)) \right|_{t=0} = \left. \frac{d}{dt}(p \exp(At)) \right|_{t=0}. \tag{34.3}$$

Note that $\gamma_A(0) = e$, i.e., the curve passes through the identity of the Lie group G . This is required because only $\mathcal{T}_e(G)$ is identified as the Lie algebra of G . Thus, any G -curve that passes through the identity induces a fundamental vector field in P . Since the action on P is right multiplication, Proposition 29.1.34 gives $(Ad_g A)^* = R_{g^*}^{-1} A^* \equiv R_{g^{-1}*} A^*$ or equivalently, $R_{g*} A^* = (Ad_{g^{-1}} A)^* \equiv (Ad_g^{-1} A)^*$.

The diffeomorphism of each fiber $\pi^{-1}(x)$ with G leads to the isomorphism of the Lie algebra \mathfrak{g} of G with the tangent space $T_p(\pi^{-1}(x))$ at each point p of the fiber; and since the action of G is confined to a fiber, the fundamental field A^* must also be confined to the tangent spaces of the fibers. To “connect” one fiber to its neighbor, we use the fundamental vector fields defined on them. This is a natural thing to do since each A^* originates from the same $A \in \mathfrak{g}$.

Is there anyway that we can make an association of A^* with its origin A in \mathfrak{g} ? Is there a “machine” that spits out A when A^* is fed into it? The most obvious answer is a \mathfrak{g} -valued one form! So define a \mathfrak{g} -valued 1-form ω by $\omega(A^*) = A$. How would ω change on $T_p(\pi^{-1}(x))$? The right action of G on $T_p(\pi^{-1}(x))$ induces a right transformation $R_g^* \omega$. What would this give when acting on A^* ?

$$R_g^* \omega(A^*) \equiv \omega(R_{g*} A^*) = \omega((Ad_g^{-1} A)^*) = Ad_g^{-1} A = Ad_g^{-1} \omega(A^*).$$

Therefore, if a 1-form is to associate A^* with A , it must satisfy $R_g^* \omega = Ad_g^{-1} \omega$. When extended to the entire P (not just $\pi^{-1}(x)$), ω defines a connection on P .

Definition 34.2.1 A connection Γ is a \mathfrak{g} -valued 1-form ω on P such that for any vector field $\mathbf{X} \in T(P)$, $\omega(\mathbf{X})$ is the unique $A \in \mathfrak{g}$ related to A^* that passes through that point. We demand that ω satisfy the following conditions:

connection 1-form

- (a) $\omega(A^*) = A$.
- (b) $R_g^* \omega = Ad_g^{-1} \omega$ on P , i.e., for any vector field $\mathbf{X} \in T(P)$,

$$\omega(R_{g*} \mathbf{X}) = Ad_g^{-1} \omega(\mathbf{X}).$$

We call ω a **connection 1-form**.

Any vector field \mathbf{Y} in $T(P)$ can be written as $\mathbf{Y} = \mathbf{Y}_h + A^*$ with A^* in the tangent space of a fiber. Then, since $\omega(\mathbf{Y}) = \omega(A^*)$, we get $\omega(\mathbf{Y}_h) = 0$. A vector field \mathbf{X} in P satisfying $\omega(\mathbf{X}) = 0$ is called a **horizontal** vector field. A vector \mathbf{Z} in a tangent space of a fiber has the property that $\pi_*(\mathbf{Z}) = 0$, because π is the constant map on any fiber: $\pi : \pi^{-1}(x) \rightarrow x$ (see Box 28.3.3). Any vector field \mathbf{Y} in P satisfying $\pi_*(\mathbf{Z}) = 0$ is called a **vertical** vector field.² If we define the horizontal and vertical subspaces as

horizontal and vertical vector fields

$$H = \{\mathbf{X} \in T(P) \mid \omega(\mathbf{X}) = 0\}, \quad V = \{\mathbf{Z} \in T(P) \mid \pi_*(\mathbf{Z}) = 0\},$$

then $T(P) = H \oplus V$. Furthermore, because of (b) in the definition above, $H_{pg} = R_{g*} H_p$. Thus, at every point of P , $T(P)$ can be written as the direct sum of a horizontal and a vertical subspace and these subspaces are smoothly connected to each other. From local trivialization, we conclude that $\dim P = \dim M + \dim G$, and since $\dim V = \dim G$, we obtain $\dim H = \dim M$. Hence, $\pi_* : H_p \rightarrow T_x(M)$ is a linear isomorphism.

π_* is a linear isomorphism of H_p and $T_x M$.

34.2.1 Local Expression for a Connection

The local trivialization of a bundle with its corresponding sections could be used to define a \mathfrak{g} -valued 1-form on the base manifold M . The pull-back of ω by a local section σ_u is indeed a \mathfrak{g} -valued 1-form on $U \subset M$: For $\mathbf{Y} \in T(U)$, we have (by definition) $\sigma_u^* \omega(\mathbf{Y}) = \omega(\sigma_{u*} \mathbf{Y})$. Since local sections depend on the subsets chosen, and since they are connected via transition functions as in Eq. (34.1), we have to know how $\omega_u \equiv \sigma_u^* \omega$ is related to $\omega_v \equiv \sigma_v^* \omega$. To take full advantage of formalism, let us write Eq. (34.1) as a composite map

$$\sigma_v : U \cap V \xrightarrow{\alpha} P \times G \xrightarrow{\Phi} P,$$

²See the remark after Definition 34.1.1.

where $\alpha(x) = (\sigma_u(x), g_{uv}(x))$ and $\Phi(\sigma_u(x), g_{uv}(x)) = \sigma_u(x)g_{uv}(x)$. Then $\sigma_{v*} = \Phi_* \circ \alpha_*$, and using Proposition 28.3.7, we obtain

$$\sigma_{v*}(\mathbf{Y}) = \Phi_*(\alpha_*\mathbf{Y}) = \Phi_{\sigma_u(x)*}(g_{uv*}(\mathbf{Y})) + \Phi_{g_{uv}(x)*}(\sigma_{u*}(\mathbf{Y})). \tag{34.4}$$

In the second term on the right, $\Phi_{g_{uv}(x)*} = R_{g_{uv}(x)*}$, the right multiplication. For the first term, we note that

$$\Phi_{\sigma_u(x)*}(g_{uv*}(\mathbf{Y})) = \left. \frac{d}{dt}(\sigma_u(x)g_{uv}(\gamma_Y(t))) \right|_{t=0}.$$

Now, we note that $\sigma_u(x)$ is a point in P and $g_{uv}(\gamma_Y(t))$ is a curve in G . Therefore, $\sigma_u(x)g_{uv}(\gamma_Y(t))$ is a curve in P . It is not the curve of a fundamental vector field, because $g_{uv}(\gamma_Y(0)) = g_{uv}(x) \neq e$. However, if we rewrite it as

$$\begin{aligned} \sigma_u(x)g_{uv}(x)g_{uv}(x)^{-1}g_{uv}(\gamma_Y(t)) &= \sigma_v(x) \underbrace{g_{uv}(x)^{-1}g_{uv}(\gamma_Y(t))}_{\equiv \gamma_{A^Y}(t)} \\ &\equiv \sigma_v(x)\gamma_{A^Y}(t), \end{aligned}$$

then $\gamma_{A^Y}(0) = e$ and the vector field associated with $\gamma_{A^Y}(t)$ is indeed a fundamental vector field. It is clear that $A^Y = L_{g_{uv}(x)^{-1}*}g_{uv*}(\mathbf{Y}) = L_{g_{uv}(x)*}^{-1}g_{uv*}(\mathbf{Y})$. We therefore, write Eq. (34.4) as

$$\sigma_{v*}(\mathbf{Y}) = A_{\sigma_v(x)}^{Y*} + R_{g_{uv}(x)*}(\sigma_{u*}(\mathbf{Y})). \tag{34.5}$$

Applying ω on both sides, we get

$$\omega(\sigma_{v*}(\mathbf{Y})) \equiv \omega_v(\mathbf{Y}) = \omega(A_{\sigma_v(x)}^{Y*}) + \omega(R_{g_{uv}(x)*}(\sigma_{u*}(\mathbf{Y}))),$$

or
local connection forms
defined on M

$$\omega_v(\mathbf{Y}) = L_{g_{uv}(x)*}^{-1}g_{uv*}(\mathbf{Y}) + Ad_{g_{uv}(x)}^{-1}\omega_u(\mathbf{Y}), \tag{34.6}$$

where for the first term on the right-hand side, we used (a) and for the second term we used (b) of Definition 34.2.1.

Let θ be the left-invariant canonical 1-form of Definition 29.1.29. For each $U \cap V$ define a \mathfrak{g} -valued 1-form by $\theta_{uv} = g_{uv}^*\theta$. Then it can be shown that Eq. (34.6) can be written succinctly as

$$\omega_v = \theta_{uv} + Ad_{g_{uv}}^{-1}\omega_u. \tag{34.7}$$

We defined the connection Γ on a principal fiber bundle as a \mathfrak{g} -valued 1-form having properties (a) and (b) of Definition 34.2.1. Then we showed two important consequences of the definition: that the 1-form splits $T(P)$ into horizontal and vertical subspaces at each point of the bundle; and that it defines a \mathfrak{g} -valued 1-form on each domain of the local trivializations and these 1-forms are connected by (34.6). It turns out that the two consequences are actually equivalent to the definition, i.e., that if $T_p(P) = H_p \oplus V_p$ at each $p \in P$ such that $H_{pg} = R_{g*}H_p$, then there exists a 1-form satisfying (a) and (b) of Definition 34.2.1. Similarly, the existence of a \mathfrak{g} -valued 1-form ω_u

on the domain U of each trivialization T_u leads to the \mathfrak{g} -valued 1-form of Definition 34.2.1.

Example 34.2.2 Suppose that G is a matrix group, i.e., a subgroup of $GL(n, \mathbb{R})$. Then g_{uv} is a matrix-valued function or 0-form. Hence, $g_{uv*} = dg_{uv}$ (see the discussion on page 874), and $L_{g_{uv}(x)*}^{-1}$ is just left multiplication by $g_{uv}^{-1}(x)$. Thus the first term on the right-hand side of Eq. (34.6) is $g_{uv}^{-1}(x)dg_{uv}(\mathbf{Y})$. For the second term, we note that for matrices A and B , we have

$$Ad_{AB} = \frac{d}{dt} Ad_A(\gamma_B(t)) \Big|_{t=0} = \frac{d}{dt} (A\gamma_B(t)A^{-1}) \Big|_{t=0} = ABA^{-1}.$$

Therefore, $Ad_{g_{uv}(x)}^{-1}\omega_u(\mathbf{Y}) = g_{uv}(x)^{-1}\omega_u(\mathbf{Y})g_{uv}(x)$. Consequently, the transformation rule (34.6) can be expressed as

$$\omega_v = g_{uv}^{-1}dg_{uv} + g_{uv}^{-1}\omega_u g_{uv}, \tag{34.8}$$

local connection forms
when G is a matrix
group

where it is understood that the vector field will be evaluated by dg_{uv} and ω_u on the right-hand side.

34.2.2 Parallelism

The diffeomorphism of $\pi^{-1}(U)$ with $U \times G$ given by a local trivialization gives rise to an isomorphism of $T_p(P)$ and $T_x(U) \times T_g(G)$. A connection splits $T_p(P)$ into a horizontal subspace and a vertical subspace, of which the vertical subspace is isomorphic to $T_g(G)$. Therefore, the horizontal subspace must be isomorphic to $T_x(U) = T_x(M)$. In fact since $\pi_*(V_p) = 0$, π_* maps the horizontal subspace isomorphically to $T_x(M)$, $\pi_* : H_p \xrightarrow{\cong} T_x(M)$.

Definition 34.2.3 The **horizontal lift** (or simply the **lift**) of a vector field \mathbf{X} on M is the unique vector field \mathbf{X}^* on P , which is horizontal and $\pi_*(\mathbf{X}_p^*) = \mathbf{X}_{\pi(p)}$ for every $p \in P$.

horizontal lift of vector
fields

From the lift of a vector field, we can move on to the lift of a curve in M . Given a curve $\gamma(t) \equiv x_t$ in M , we can lift each point of it into P and get a curve $\gamma^*(t) \equiv p_t$ in P in such a way that the tangent vector to γ^* is horizontal and maps to the tangent vector to γ at its corresponding point. More precisely,

Definition 34.2.4 Let $\gamma(t) \equiv x_t$ be a curve in M . A **horizontal lift** (or simply the **lift**) of γ is a horizontal curve $\gamma^*(t) \equiv p_t$ in P such that $\pi(\dot{\gamma}^*(t)) = \dot{\gamma}(t)$. By a horizontal curve is meant one whose tangent vectors are horizontal.

horizontal lift of curves

By local triviality, a curve $\gamma(t)$ in $U \subset M$ maps to a curve $\alpha(t)$ in P , which may not be horizontal. If there is a horizontal curve $\gamma^*(t)$, each of its points can be obtained from $\alpha(t)$ by right multiplication by an element of G , because $\alpha(t)$ and $\gamma^*(t)$ both belong to the same fiber for each given t . So, we have $\gamma^*(t) = \alpha(t)g(t)$. The question is if this construction actually works. The answer is yes, and we have the following proposition, whose proof can be found in [Koba 63, pp. 69–70]:

Proposition 34.2.5 *Let $\gamma(t)$, $0 \leq t \leq 1$, be a curve in M . For an arbitrary point p_0 of P with $\pi(p_0) = \gamma(0)$, there exists a unique horizontal lift γ^* of γ starting at p_0 (i.e., with $\gamma^*(0) = p_0$). Furthermore, the unique lift that starts at $p = p_0g$ is $\gamma^*(t)g$.*

Let $\gamma = x_t$, $0 \leq t \leq 1$ be a curve in M . Let p_0 be an arbitrary point in P with $\pi(p_0) = \gamma(0) = x_0$. The unique lift γ^* of γ through p_0 has the end point $p_1 = \gamma^*(1)$ such that $\pi(p_1) = \gamma(1) = x_1$. By varying p_0 in the fiber $\pi^{-1}(x_0)$, we obtain a bijection for the two fibers $\pi^{-1}(x_0)$ and $\pi^{-1}(x_1)$. Denote this mapping by the same letter γ and call it the **parallel displacement** along the curve γ .

parallel displacement of fibers

The notion of parallelism can be extended to the associated bundles as well. For this, we need to split the tangent spaces of E into horizontal and vertical at all points $w \in E$. If $\pi_E(w) = x \in M$, then the tangent space to $\pi_E^{-1}(x)$ at w , denoted by V_w , is by definition the *vertical* subspace. Let $\pi_G : P \times F \rightarrow E$ be the natural projection, so that $\pi_G(p, \xi) = \llbracket p, \xi \rrbracket \equiv w$. Choose a pair $(p, \xi) \in \pi_G^{-1}(w)$. If you fix p and let ξ vary over the entire F , by Theorem 34.1.14, you get a diffeomorphic image of F , namely $\pi_E^{-1}(x)$ if $\pi_E(w) = x$. More precisely, the diffeomorphism $p : F \rightarrow \pi_E^{-1}(x)$ has the differential map $p_* : T(F) \rightarrow T(\pi_E^{-1}(x))$ and $V_w = p_*(T(F))$.

horizontal and vertical subspaces of the associated bundle

The procedure described above for obtaining the vertical subspace gives us a hint for defining the horizontal subspace H_w as follows. Instead of fixing p , now fix ξ and let p vary. More precisely, define the map $f_\xi : P \rightarrow E$ by $f_\xi(p) = p\xi$ with differential $f_{\xi*} : T_p(P) \rightarrow T_w(E)$. Define the horizontal subspace of $T_w(E)$ to be the image of the horizontal subspace H_p of $T_p(P)$. So, $H_w \equiv f_{\xi*}(H_p)$. For this assignment to be meaningful (well-defined), it must be independent of the choice (p, ξ) .

Proposition 34.2.6 *If $\pi_G(p_1, \xi_1) = w = \pi_G(p_2, \xi_2)$, then $f_{\xi_1*}(H_{p_1}) = f_{\xi_2*}(H_{p_2})$.*

Proof First note that $f_{g\xi} = f_\xi \circ R_g$. Next note that if $\pi_G(p_1, \xi_1) = \pi_G(p_2, \xi_2)$, then there must exist a $g \in G$ such that $p_2 = p_1g^{-1}$ and $\xi_2 = g\xi_1$. Now use these two facts plus the invariance of the horizontal space H_p under right translation to prove the statement. \square

From the diffeomorphism of $\pi_E^{-1}(U)$ and $U \times F$, and the fact that U is an open submanifold of M , we conclude that

$$\dim T_w(E) = \dim T_x(M) + \dim T_\xi(F) = \dim T_x(M) + \dim V_w.$$

From the diffeomorphism of $\pi^{-1}(U)$ and $U \times G$, and the split of $T_p(P)$ into horizontal and vertical subspaces, we conclude that

$$\begin{aligned} \dim H_p + \dim V_p &= \dim T_p(P) = \dim T_x(M) + \dim T_g(G) \\ &= \dim T_x(M) + \dim V_p \end{aligned}$$

so that $\dim H_p = \dim T_x(M)$. Furthermore, one can show that f_ξ is an injection. Hence, $\dim H_w = \dim H_p$, and therefore, $\dim H_w = \dim T_x(M)$. This, plus the first equation above yields $T_w(E) = H_w \oplus V_w$.

Definition 34.2.7 A vector field \mathbf{Z} in E is **horizontal** if $\mathbf{Z} = f_{\xi*}(\mathbf{X}^*)$ for some horizontal vector field \mathbf{X}^* in P . A curve in E is horizontal if its tangent vector is horizontal at each point of the curve. Given a curve γ in M , a **(horizontal) lift** is a horizontal curve γ_E^* in E such that $\pi_E(\gamma^*) = \gamma$.

horizontal lift in the associated bundle

Just as there was a unique horizontal lift for every curve γ in M starting at a given point of the principal fiber bundle P , so is there a unique horizontal lift of every curve γ in M starting at a given point of the associated bundle E . In fact, let $\gamma(t) = x_t$ be a curve in M . Let $w_0 \in E$ be such that $\pi_E(w_0) = x_0$. Then there is a $p_0 \in P$ such that $p_0\xi = w_0$. Let $\gamma^*(t) = p_t$ be the lift of x_t starting at p_0 . Let $w_t = p_t\xi$. Then w_t is a horizontal curve starting at w_0 . The fact that it is unique follows from the uniqueness of the solution of differential equations with give initial conditions. We thus have

Theorem 34.2.8 Given a curve $\gamma(t) = x_t, 0 \leq t \leq 1$ in M and a point $w_0 \in E$ such that $\pi_E(w_0) = x_0$, there is a unique lift $\gamma_E^*(t) = w_t$ starting at w_0 . In fact, if $w_0 = \llbracket p_0, \xi \rrbracket$, then $w_t = p_t\xi$, where p_t is the lift of x_t in P starting at p_0 .

Recall that a (cross) section σ of E is a map $\sigma : U \rightarrow E$ such that $\pi_E\sigma(x) = x$. Let $x_t, 0 \leq t \leq 1$ be a curve in U . Let $w_0 = \sigma(x_0)$. Then, clearly $\sigma(x_t)$ is a curve in E starting at w_0 . Let w_t be the horizontal lift of x_t starting at w_0 . In general, of course, $w_t \neq \sigma(x_t)$.

parallel section

Definition 34.2.9 We say the section σ of E is **parallel** if $\sigma(x_t), 0 \leq t \leq 1$ is the horizontal lift of x_t .

34.3 Curvature Form

A connection is a 1-form on P which allows a parallel displacement of sections of its associated bundles. Infinitesimal displacements carry the notion of differentiation which is important in differential geometry. As a 1-form, the connection accepts another kind of differentiation, namely exterior derivative. But this differentiation ought to be generalized so that it is compatible with the action of the structure group.

pseudotensorial and tensorial forms

Definition 34.3.1 Let $P(M, G)$ be a principal fiber bundle and $\rho : G \rightarrow GL(\mathcal{V})$ a representation of the structure group on a vector space \mathcal{V} . A **pseudotensorial form** of degree r on P of type (ρ, \mathcal{V}) is a \mathcal{V} -valued r -form ϕ on P such that

$$R_g^* \phi = \rho(g^{-1}) \cdot \phi.$$

ϕ is called a **tensorial form** if $\phi(\mathbf{X}_1, \mathbf{X}_2, \dots, \mathbf{X}_r) = 0$ when any of the $\mathbf{X}_i \in T(P)$ is vertical. In this case we say that ϕ is horizontal.

Example 34.3.2 (a) Let ρ be the adjoint representation $Ad : g \rightarrow GL(\mathfrak{g})$ given in Definition 29.1.26. Then (b) of Definition 34.2.1 shows that the connection form ω is a pseudotensorial form of degree 1 of type (Ad, \mathfrak{g}) .

(b) Let ρ_0 be the trivial representation, sending all elements of G to the identity of $GL(\mathcal{V})$. Then a tensorial form of degree r of type (ρ_0, \mathcal{V}) is simply an r -form on P which can be written as $\phi = \pi^* \phi_M$ where ϕ_M is a \mathcal{V} -valued r -form on the base manifold M . In particular, if $\mathcal{V} = \mathbb{R}$, then ϕ is the pull-back by π of an ordinary r -form on M .

Remark 34.3.1 Let $E(M, \mathcal{V}, G, P)$ be the bundle associated with the principal fiber bundle P with standard fiber \mathcal{V} on which G acts through a representation ρ . A tensorial form ϕ of degree r of type (ρ, \mathcal{V}) can be considered as an assignment to each x a multilinear skewsymmetric mapping $\tilde{\phi}_x$ of $T_x(M) \times T_x(M) \times \dots \times T_x(M)$ (r times) into the vector space $\pi_E^{-1}(x)$ which is the fiber of E over x . Here is how:

$$\tilde{\phi}_x(\mathbf{X}_1, \mathbf{X}_2, \dots, \mathbf{X}_r) \equiv p(\phi(\mathbf{X}_1^*, \mathbf{X}_2^*, \dots, \mathbf{X}_r^*)), \quad \mathbf{X}_i \in T_x(M). \quad (34.9)$$

On the right-hand side, \mathbf{X}_i^* is any vector field at p such that $\pi_*(\mathbf{X}_i^*) = \mathbf{X}_i$, and p is any point of P with $\pi(p) = x$. Since ϕ is \mathcal{V} -valued, $\phi(\mathbf{X}_1^*, \mathbf{X}_2^*, \dots, \mathbf{X}_r^*)$ is in \mathcal{V} , the standard fiber of E , on which p acts according to Theorem 34.1.14 to give a vector in $\pi_E^{-1}(x)$. As Problem 34.12 shows, the left-hand side of Eq. (34.9) is independent of the choice of p and \mathbf{X}_i^* on the right-hand side. Conversely, given a skewsymmetric multilinear mapping $\tilde{\phi}_x$ of $T_x(M) \times T_x(M) \times \dots \times T_x(M)$ to $\pi_E^{-1}(x)$ for each $x \in M$, $p^{-1} \circ \tilde{\phi}_x \circ \pi_*$ is a tensorial r -form of type (ρ, \mathcal{V}) , with p chosen such that $\pi(p) = x$. In particular, a cross section $\tilde{f} : M \rightarrow E$ can be identified with $f = p^{-1} \circ \tilde{f} \circ \pi$, which is a \mathcal{V} -valued function on P satisfying $f(pg) = \rho(g^{-1})f(p)$.

In the special case where ρ is the identity representation and $\mathcal{V} = \mathbb{R}$, $\tilde{\phi}$ is just an ordinary r -form, i.e., $\tilde{\phi} \in \Lambda^r(M)$.

Let $P(M, G)$ be a principal fiber bundle with a connection, giving rise to the split $T_p(P) = H_p \oplus V_p$ into horizontal and vertical subspaces at each point $p \in P$. Define $h : T_p(P) \rightarrow H_p$ to be the projection onto the horizontal subspace. For a pseudotensorial r -form ϕ on P , define ϕh by

$$(\phi h)(\mathbf{X}_1, \mathbf{X}_2, \dots, \mathbf{X}_r) = \phi(h\mathbf{X}_1, h\mathbf{X}_2, \dots, h\mathbf{X}_r), \quad \mathbf{X}_i \in T_p(P). \quad (34.10)$$

Definition 34.3.3 Let $P(M, G)$ be a principal fiber bundle with a connection 1-form ω that induces the split $T_p(P) = H_p \oplus V_p$. Let $h : T_p(P) \rightarrow H_p$ be the projection onto the horizontal subspace. The **exterior covariant derivative** (associated with ω) of a (pseudo)tensorial r -form ϕ is defined as $D^\omega \phi = (d\phi)h$ and D^ω is called the **exterior covariant differentiation**.

The proof of the following proposition is straightforward:

Proposition 34.3.4 Let ϕ be a pseudotensorial r -form on P of type (ρ, \mathcal{V}) . Then

- (a) the form ϕh is a tensorial r -form of type (ρ, \mathcal{V}) ;
- (b) $d\phi$ is a pseudotensorial $(r + 1)$ -form of type (ρ, \mathcal{V}) ;
- (c) $D^\omega \phi$ is a tensorial $(r + 1)$ -form of type (ρ, \mathcal{V}) .

Definition 34.3.5 The tensorial 2-form $\Omega^\omega \equiv D^\omega \omega$ of type (Ad, \mathfrak{g}) is called the **curvature form** of ω .

The proof of the following **structure equation** can be found in [Koba 63, pp. 77–78]

Theorem 34.3.6 The curvature form Ω^ω of the connection form ω satisfies the following equation:

$$\Omega^\omega(\mathbf{X}, \mathbf{Y}) = d\omega(\mathbf{X}, \mathbf{Y}) + \frac{1}{2}[\omega(\mathbf{X}), \omega(\mathbf{Y})], \quad \mathbf{X}, \mathbf{Y} \in T_p(P).$$

The equation of this theorem is abbreviated as **structure equation**

$$\Omega^\omega = d\omega + \frac{1}{2}[\omega, \omega]. \tag{34.11}$$

The commutator in (34.11) is a Lie algebra commutator (in particular, it is not zero). In fact, Eq. (34.13) below captures the meaning of (34.11).

If \mathbf{X} and \mathbf{Y} are both horizontal vector fields on P , then Theorem 28.5.11 yields

$$\Omega^\omega(\mathbf{X}, \mathbf{Y}) = -\omega([\mathbf{X}, \mathbf{Y}]). \tag{34.12}$$

Note that the right-hand side is not zero, because the Lie bracket of two horizontal vector fields is not necessarily horizontal.

It is convenient to have an expression for the structure equation in terms of real-valued forms. So, let $\{\mathbf{E}_i\}_{i=1}^m$ be a basis for the Lie algebra \mathfrak{g} with structure constants c_{jk}^i , so that

$$[\mathbf{E}_j, \mathbf{E}_k] = c_{jk}^i \mathbf{E}_i, \quad j, k = 1, 2, \dots, m.$$

As \mathfrak{g} -valued forms, ω and Ω^ω can be expressed as $\omega = \omega^i \mathbf{E}_i$ and $\Omega^\omega = \Omega^i \mathbf{E}_i$, where ω^i and Ω^i are ordinary real-valued forms. It is straightforward to show that the structure equation can be expressed as

$$\Omega^i = d\omega^i + \frac{1}{2}c^i_{jk}\omega^j \wedge \omega^k, \quad i = 1, 2, \dots, m. \tag{34.13}$$

Taking the exterior derivative of both sides of this equation, one can show that

$$d\Omega^i = c^i_{jk}d\omega^j \wedge \omega^k, \quad \text{or} \quad d\Omega^\omega = [\Omega^\omega, \omega]. \tag{34.14}$$

The proof of the following theorem, which follows easily from the last two equations, is left as an exercise for the reader (see Problem 34.16):

Bianchi's identity

Theorem 34.3.7 (Bianchi's identity) $D^\omega \Omega^\omega = 0$.

In Sect. 34.2.1, we expressed a connection Γ in terms of its 1-form defined on the base manifold M . It is instructive to obtain similar expressions for the curvature form as well. In fact, since the local connection form was simply the pull-back by the local sections, and since the exterior derivative and exterior product both commute with the pullback, we define $\Omega_u^\omega \equiv \sigma_u^* \Omega^\omega$ and easily prove

Theorem 34.3.8 $\Omega_u^\omega = d\omega_u + \frac{1}{2}[\omega_u, \omega_u]$.

We found how different pieces of the connection 1-form, defined on different subsets of M , were related to each other (see (34.6)). We can do the same with the curvature 2-form. Using Eq. (34.5) and the definition of pull-back, we find

$$\begin{aligned} \Omega_v^\omega(\mathbf{X}, \mathbf{Y}) &\equiv \sigma^{v*} \Omega^\omega(\mathbf{X}, \mathbf{Y}) = \Omega^\omega(\sigma_{v*} \mathbf{X}, \sigma_{v*} \mathbf{Y}) \\ &= \Omega^\omega(A_{\sigma_v(x)}^{X*} + R_{g_{uv}(x)*}(\sigma_{u*} \mathbf{X}), A_{\sigma_v(x)}^{Y*} + R_{g_{uv}(x)*}(\sigma_{u*} \mathbf{Y})) \\ &= \Omega^\omega(R_{g_{uv}(x)*}(\sigma_{u*} \mathbf{X}), R_{g_{uv}(x)*}(\sigma_{u*} \mathbf{Y})), \end{aligned}$$

because Ω^ω is a *tensorial* form, and hence, gives zero for its vertical arguments. By Proposition 34.3.4, Ω^ω is of the same type as ω , i.e., of type (Ad, \mathfrak{g}) . Therefore, we have

$$\Omega_v^\omega(\mathbf{X}, \mathbf{Y}) = Ad_{g_{uv}^{-1}} \Omega^\omega(\sigma_{u*} \mathbf{X}, \sigma_{u*} \mathbf{Y}) = Ad_{g_{uv}^{-1}} \sigma^{u*} \Omega^\omega(\mathbf{X}, \mathbf{Y}),$$

or

$$\Omega_v^\omega = Ad_{g_{uv}^{-1}} \Omega_u^\omega \tag{34.15}$$

Using Eq. (34.14), a similar derivation leads to the local version of the Bianchi's identity:

$$d\Omega_u^\omega = [\Omega_u^\omega, \omega_u]. \tag{34.16}$$

All the foregoing discussion simplifies considerably if the structure group is abelian. In this case all the structure constants c^i_{jk} vanish and Equations (34.13) and (34.14) become $\Omega^i = d\omega^i$ and $d\Omega^i = 0$, respectively. Furthermore, it can be shown (Problem 34.17) that $Ad_g = \text{id}_{\mathfrak{g}}$, the identity of the Lie algebra of G . We summarize all this in

The abelian case

Proposition 34.3.9 *If the structure group is abelian, then*

$$\begin{aligned} \omega_v &= \theta_{uv} + \omega_u, & \Omega^\omega &= d\omega, & d\Omega^\omega &= 0, \\ \Omega_u^\omega &= d\omega_u, & \Omega_v^\omega &= \Omega_u^\omega \end{aligned}$$

where θ_{uv} is as in Eq. (34.7) and represents the first term on the right-hand side of Eq. (34.6).

34.3.1 Flat Connections

Let $P = M \times G$ be a trivial principal fiber bundle. Let $\pi_2 : M \times G \rightarrow G$ be the projection onto the second factor. The differential of this map, $\pi_{2*} : T(M) \times T(G) \rightarrow T(G)$, has the property that $\pi_{2*}(\mathbf{X}) = 0$ if $\mathbf{X} \in T(M)$ (see Box 28.3.3). With θ the canonical left-invariant 1-form on G , let $\omega = \pi_2^*\theta$. Then ω is a 1-form on P , and one can show that it satisfies the two conditions of Definition 34.2.1. Hence, ω is a connection on P . The horizontal space of this connection is clearly $T(M)$. The connection associated with this ω is called the **canonical flat connection** of P . The Maurer-Cartan equation (29.17) yields

canonical flat connection

$$\begin{aligned} d\omega &= d(\pi_2^*\theta) = \pi_2^*(d\theta) = \pi_2^*\left(-\frac{1}{2}[\theta, \theta]\right) \\ &= -\frac{1}{2}[\pi_2^*(\theta), \pi_2^*(\theta)] = -\frac{1}{2}[\omega, \omega]. \end{aligned}$$

Comparison with Eq. (34.11) implies that the curvature of the canonical flat connection is zero.

Definition 34.3.10 A connection Γ in any principal fiber bundle $P(M, G)$ is called **flat** if every $x \in M$ has a neighborhood U such that the connection in $\pi^{-1}(U)$ is isomorphic to the canonical flat connection in $U \times G$.

flat connection

The vanishing of the curvature is a necessary condition for a connection to be flat. It turns out that it is also sufficient (see [Koba 63, p. 92] for a proof):

Theorem 34.3.11 *A connection in a principal fiber bundle $P(M, G)$ is flat if and only if the curvature form vanishes identically.*

The existence of a flat connection in a principal fiber bundle determines the nature of the bundle:

Corollary 34.3.12 *If $P(M, G)$ has a connection whose curvature form vanishes identically, then $P(M, G)$ is (isomorphic to) the trivial bundle $M \times G$ and the connection is the canonical flat connection.*

34.3.2 Matrix Structure Group

The structure groups encountered in physics are almost exclusively matrix groups, or subgroups of $GL(n, \mathbb{R})$. For these groups, the equations derived above take a simpler form [see, for example, Eq. (34.8)]. Furthermore, it is a good idea to have these special formulas, so we can use them when need arises.

Proposition 34.3.13 *Let N be a manifold and G a matrix Lie group with Lie algebra \mathfrak{g} . For $\phi \in \Lambda^k(N, \mathfrak{g})$ and $\psi \in \Lambda^j(N, \mathfrak{g})$, we have*

$$[\phi, \psi] = \phi \wedge \psi - (-1)^{kj} \psi \wedge \phi$$

where ϕ and ψ are regarded as matrices of \mathbb{R} -valued forms and $\phi \wedge \psi$ is matrix multiplication with elements multiplied via wedge product.

Proof For matrix algebras, the commutator is just the difference in products of matrices. Therefore,

$$\begin{aligned} & [\phi, \psi](\mathbf{X}_1, \dots, \mathbf{X}_{k+j}) \\ & \equiv \frac{1}{k!j!} \sum_{\pi} \epsilon_{\pi} \underbrace{\phi(\mathbf{X}_{\pi(1)}, \dots, \mathbf{X}_{\pi(k)}) \psi(\mathbf{X}_{\pi(k+1)}, \dots, \mathbf{X}_{\pi(k+j)})}_{=(\phi \wedge \psi)(\mathbf{X}_1, \dots, \mathbf{X}_{k+j})} \\ & \quad - \frac{1}{k!j!} \sum_{\pi} \epsilon_{\pi} \psi(\mathbf{X}_{\pi(k+1)}, \dots, \mathbf{X}_{\pi(k+j)}) \phi(\mathbf{X}_{\pi(1)}, \dots, \mathbf{X}_{\pi(k)}) \\ & = (\phi \wedge \psi)(\mathbf{X}_1, \dots, \mathbf{X}_{k+j}) \\ & \quad - \frac{1}{k!j!} \sum_{\pi} \epsilon_{\pi} (-1)^{kj} \psi(\mathbf{X}_{\pi(1)}, \dots, \mathbf{X}_{\pi(j)}) \phi(\mathbf{X}_{\pi(j+1)}, \dots, \mathbf{X}_{\pi(j+k)}). \end{aligned}$$

Noting that the last sum is $(-1)^{kj} (\psi \wedge \phi)(\mathbf{X}_1, \dots, \mathbf{X}_{k+j})$, we obtain the result we are after. \square

Corollary 34.3.14 *If G is a matrix group, then*

$$\Omega^{\omega} = d\omega + \omega \wedge \omega \quad \text{and} \quad \Omega_u^{\omega} = d\omega_u + \omega_u \wedge \omega_u.$$

Proof The proof follows immediately from Eq. (34.11) and Proposition 34.3.13 with $k = j = 1$. \square

The following theorem can also be easily proved:

Theorem 34.3.15 Let T_u and T_v be two local trivializations with transition function $g_{uv} : U \cap V \rightarrow G$, where G is a matrix group. Then

- (a) $\Omega_v^\omega = g_{uv}^{-1} \Omega_u^\omega g_{uv}$;
 (b) $d\Omega_u^\omega = \Omega_u^\omega \wedge \omega_u - \omega_u \wedge \Omega_u^\omega$.

34.4 Problems

34.1 Show that

- (a) a fiber bundle homomorphism preserves the fibers, i.e., two points belonging to the same fiber of P' get mapped to the same fiber of P ;
 (b) if (f, f_G) of Definition 34.1.3 is an isomorphism, then the induced map $f_M : M' \rightarrow M$ is a bijection.

34.2 Finish the proof of Proposition 34.1.5.

34.3 Complete the proof of Proposition 34.1.9.

34.4 Using the linear independence of the vectors in a basis, show that the action of $GL(n, \mathbb{R})$ on $L(M)$ is free.

34.5 Show that $\phi_u : \pi^{-1}(U) \rightarrow U \times F$ defined by $\phi_u(\llbracket p, \xi \rrbracket) = (\pi(p), s_u(p)\xi)$ for the associated fiber bundle is well defined (i.e., if $\llbracket p', \xi' \rrbracket = \llbracket p, \xi \rrbracket$ then $\phi_u(\llbracket p', \xi' \rrbracket) = \phi_u(\llbracket p, \xi \rrbracket)$) and bijective.

34.6 Show that the map $p : E \rightarrow F_x$, given by $p(\xi) \equiv p\xi = \llbracket p, \xi \rrbracket$ satisfies

$$(pg)\xi = p(g\xi) \quad \text{for } p \in P, g \in G, \xi \in E.$$

34.7 Show that the map $S_u : U \times G \rightarrow \pi^{-1}(U)$, given by $S_u(x, g) = \sigma_u(x)g$ for a local cross section σ_u is a bijection, and that $T_u = S_u^{-1}$ is a local trivialization satisfying condition (3) of Definition 34.1.1.

34.8 Provide the details of the proof of Proposition 34.2.6.

34.9 Show that the map $f_\xi : P \rightarrow E$ defined by $f_\xi(p) = p\xi$ is injective. Hint: Show that $\llbracket p_1, \xi \rrbracket = \llbracket p_2, \xi \rrbracket$ implies $p_1 = p_2$.

34.10 Show that Eq. (34.7) follows from Eq. (34.6).

34.11 Show that the canonical flat connection on $P = M \times G$ given by $\omega = \pi_2^* \theta$, where θ is the canonical 1-form on G satisfies both conditions of Definition 34.2.1.

34.12 Show that Eq. (34.9) is independent of the choice of p and \mathbf{X}_i^* on the right-hand side.

34.13 Prove Proposition [34.3.4](#).

34.14 Derive Eq. [\(34.12\)](#).

34.15 Derive Eq. [\(34.13\)](#).

34.16 Taking the exterior derivative of both sides of Eq. [\(34.13\)](#), show that

$$d\Omega^i = c^i_{jk}\Omega^j \wedge \omega^k - \frac{1}{2}c^i_{jk}c^j_{lm}\omega^l \wedge \omega^m \wedge \omega^k.$$

Using Lie's third theorem [\(29.13\)](#), show that the second term on the right-hand side vanishes. Now prove Bianchi's identity of Theorem [34.3.7](#). Hint: $\omega(\mathbf{X}) = 0$ if \mathbf{X} is horizontal.

34.17 Let $\text{id}_M : M \rightarrow M$ be the identity map on M . Prove that id_{M*} is the identity map on $T(M)$. Let $I_g = R_{g^{-1}} \circ L_g$ be the inner automorphism of a Lie group G . Show that if G is abelian, then $I_g = \text{id}_G$ for all $g \in G$. Now show that $Ad_g = \text{id}_{\mathfrak{g}}$.

34.18 Prove Theorem [34.3.8](#).

34.19 Provide the details of Corollary [34.3.14](#).

34.20 Provide the details of Theorem [34.3.15](#).

The machinery developed in Chap. 34 has found a natural setting in gauge theories, which have been successfully used to describe the electromagnetic, weak nuclear, and strong nuclear interactions. In these physical applications, one considers a principal fiber bundle $P(M, G)$, where $M = \mathbb{R}^4$ with a metric η which is diagonal with $\eta_{11} = -1 = -\eta_{ii}$ for $i = 2, 3, 4$, and the structure group is a matrix group, typically $SU(n)$.

35.1 Gauge Potentials and Fields

The application of the theory of the principal fiber bundle to physics concentrates on the local quantities. In a typical situation, one picks a local section σ_u , which in the new setting is called a **choice of gauge**, and works with $\omega_u \equiv \sigma_u^* \omega$, now called a **gauge potential**. The curvature form, being the derivative of the gauge potential is now called **gauge field**. Theorem 34.3.11 and Corollary 34.3.12 imply that all principal fiber bundles used in physics are nontrivial, because otherwise the gauge field would be identically zero.

choice of gauge; gauge potential; gauge field

Example 35.1.1 Consider the simplest (unitary) matrix group $U(1)$. Any group member can be written as $e^{i\alpha}$ with $\alpha \in \mathbb{R}$. The Lie algebra consists of just the exponents: $\mathfrak{u} = \{i\alpha \mid \alpha \in \mathbb{R}\}$, implying that the basis is $i = \sqrt{-1}$. If $\sigma_u : U \rightarrow P$, $U \subset \mathbb{R}^4$ is a local section, then ω_u is a \mathfrak{u} -valued 1-form on U . Since the Lie algebra is one-dimensional, the discussion in Sect. 34.2.1 implies that $\omega_u = iA_u$. Here A_u is a real-valued 1-form on U . Pick a coordinate basis in U and write $A_u = A_{uk} dx^k$. Note that A_u has four components $\{A_{uk}\}_{k=1}^4$. That is why it is called a **vector potential**.

Another section σ_v yields $\omega_v = iA_v$. We want to see how ω_v is related to ω_u . Since the structure group is an abelian matrix group, Eq. (34.8) and Proposition 34.3.9 give

$$\omega_v = g_{uv}^{-1} dg_{uv} + \omega_u.$$

With $g_{uv}(x) = e^{i\alpha_{uv}(x)}$, we obtain

$$dg_{uv} = d(e^{i\alpha_{uv}(x)}) = e^{i\alpha_{uv}(x)} i \partial_k \alpha_{uv} dx^k.$$

Hence, the preceding equation yields

$$iA_{vk}dx^k = e^{-i\alpha_{uv}(x)}e^{i\alpha_{uv}(x)}i\partial_k\alpha_{uv}dx^k + iA_{uk}dx^k,$$

or

$$A_{vk} = A_{uk} + \partial_k\alpha_{uv}, \quad k = 1, \dots, 4. \quad (35.1)$$

The reader may recognize this as the gauge transformation of the vector potential of electrodynamics.

The curvature can be obtained using Proposition 34.3.9, which also shows that the curvature is independent of the local section (although the connection itself is not). Thus, ignoring the subscript u , with $\omega = iA = iA_kdx^k$, we obtain

$$\Omega = d\omega = d(iA_kdx^k) = i\partial_jA_kdx^j \wedge dx^k,$$

and writing $\Omega = iF$, where F is a real-valued 2-form, yields

$$F = \partial_jA_kdx^j \wedge dx^k = \frac{1}{2}(\partial_jA_k - \partial_kA_j)dx^j \wedge dx^k.$$

The (antisymmetric) components of F are therefore,

$$F_{jk} = \partial_jA_k - \partial_kA_j,$$

which is the familiar electromagnetic field strength, with

$$\begin{aligned} E_j &= F_{1j}, & B_1 &= \partial_2A_3 - \partial_3A_2, & B_2 &= \partial_3A_1 - \partial_1A_3, \\ B_3 &= \partial_1A_2 - \partial_2A_1. \end{aligned}$$

The Bianchi's identity, $d\Omega = 0$ or $dF = 0$, in terms of components, becomes

$$0 = dF = \partial_lF_{jk}dx^l \wedge dx^j \wedge dx^k,$$

which can be shown to lead to the two homogeneous Maxwell's equations:

$$\nabla \cdot \mathbf{B} = 0, \quad \nabla \times \mathbf{E} = -\frac{\partial \mathbf{B}}{\partial t}.$$

We summarize the discussion of the preceding example:

Box 35.1.2 *Electromagnetic interaction is a principal fiber bundle $P(M, G)$ with M a Minkowski space and $G = U(1)$.*

It appears as if the P in the principal fiber bundle had no role in our discussion above. That is not so! Remember that the structure of P as a bundle is determined entirely by the transition functions (see the discussion after Proposition 34.1.5). And we used the transition functions in determining how the connection 1-forms were glued together on the base manifold.

35.1.1 Particle Fields

Principal fiber bundles give us gauge potentials and gauge fields. A gauge field is responsible for interaction among matter particles, and an interaction is typically described by a Lagrangian written in terms of fields and their derivatives. Therefore, we have to know how to describe matter (or particle) fields and how to differentiate them.

The realistic treatment of particle fields requires the introduction of the so-called **Clifford** and **spinor bundles**. This is because all fundamental particles, i.e., quarks and leptons, are described by (complex) spinors, not vectors. Although we have discussed the *algebra* of spinors, and it is indeed the starting point of the discussion of Clifford and spinor bundles, the construction of a differential structure on these bundles and its pull-back to the base manifold $M = (\mathbb{R}^4, \eta)$ is beyond the scope of this book.

Clifford and spinor bundles

Therefore, we restrict our discussion to the (admittedly unphysical) case, where particles are described by vectors rather than spinors. This brief discussion is not entirely useless, because there are certain similarities between vector bundles and spinor bundles, and the discussion can pave the way to the understanding of the realistic case of Clifford and spinor bundles.

Definition 35.1.3 Let $P(M, G)$ be a principal fiber bundle and \mathcal{V} a vector space on which G acts (on the left) through a representation. Let $E(M, \mathcal{V}, G, P)$ be the associated bundle with standard fiber \mathcal{V} . A section of E , i.e., a map $\psi : M \rightarrow E$ is called a **particle field**.

particle field

Let $\bar{\Lambda}^k(P, \mathcal{V})$ be the set of *tensorial* forms of degree k of type (ρ, \mathcal{V}) . Let $\mathfrak{g} \rightarrow \mathfrak{gl}(\mathcal{V})$ be the Lie algebra homomorphism induced by the representation $G \rightarrow GL(\mathcal{V})$. If $\phi \in \Lambda^k(P, \mathcal{V})$ and $\mu \in \Lambda^j(P, \mathfrak{g})$, then we can define a wedge product $\hat{\wedge} : \Lambda^j(P, \mathfrak{g}) \times \Lambda^k(P, \mathcal{V}) \rightarrow \Lambda^{j+k}(P, \mathcal{V})$ as follows:

$$\begin{aligned}
 &(\mu \hat{\wedge} \phi)(\mathbf{X}_1, \dots, \mathbf{X}_{j+k}) \\
 &= \frac{1}{j!k!} \sum_{\pi} \epsilon_{\pi} \mu(\mathbf{X}_{\pi(1)}, \dots, \mathbf{X}_{\pi(j)}) \cdot \phi(\mathbf{X}_{\pi(j+1)}, \dots, \mathbf{X}_{\pi(j+k)}). \quad (35.2)
 \end{aligned}$$

Note that $\mu(\mathbf{X}_{\pi(1)}, \dots, \mathbf{X}_{\pi(j)}) \in \mathfrak{g}$ and $\phi(\mathbf{X}_{\pi(j+1)}, \dots, \mathbf{X}_{\pi(j+k)}) \in \mathcal{V}$, so the dot (symbolizing the action of the Lie algebra) between the two makes sense.

Theorem 35.1.4 Let D^{ω} be the exterior covariant differentiation of Definition 34.3.3. If $\phi \in \bar{\Lambda}^k(P, \mathcal{V})$, then

$$\begin{aligned}
 D^{\omega} \phi &= d\phi + \omega \hat{\wedge} \phi \\
 D^{\omega} D^{\omega} \phi &= \Omega \hat{\wedge} \phi.
 \end{aligned}$$

Proof The proof of the first equation involves establishing the equality for cases in which the vector fields in the argument of $D^{\omega} \phi$ (a) are all horizontal, (b) all but one are horizontal, and (c) have two or more vertical vectors. The details can be found in [Ble 81, pp. 44–45].

The second equation can be derived by taking the exterior derivative of the first and using the definition of D^ω . We have

$$D^\omega D^\omega \phi = d(d\phi + \omega \wedge \phi)h = (d\omega)h \wedge \phi h - (\omega h) \wedge (d\phi)h = D^\omega \omega \wedge \phi = \Omega \wedge \phi,$$

because $\omega h \equiv 0$ and $\phi h = \phi$. □

Corollary 35.1.5 *Let $\phi \in \bar{\Lambda}^k(P, \mathfrak{g})$ and assume that the action on \mathfrak{g} is via the adjoint representation. Then $D^\omega \phi = d\phi + [\omega, \phi]$.*

Note that there is no conflict with Eq. (34.11) because ω is a pseudotensorial form not a tensorial form.

35.1.2 Gauge Transformation

The gauge transformation of the electromagnetic vector potential (35.1) was obtained by starting with local sections glued together by a transition function and pulling back the connection 1-form using the local sections. So there is some kind of relation between gauge transformations and local sections that we want to explore now. We note that all terms of Eq. (35.1) are evaluated at the same $x \in M$. Therefore, that gauge transformation does not leave the fiber of the bundle. This is the condition that we want to impose on any gauge transformation:

gauge transformation defined

Definition 35.1.6 A gauge transformation of a principal fiber bundle $P(M, G)$ is an automorphism (f, id_G) of the bundle for which $f_M = \text{id}_M$, i.e., $\pi(p) = \pi(f(p))$. The set of all gauge transformations of $P(M, G)$ is denoted by $\text{Gau}(P)$.

Thus, a gauge transformation does not leave a fiber. We also know that the right action of the structure group is also confined to a fiber. So the natural question to ask is “Is the right action a gauge transformation?” Recall (see Definition 34.1.3) that an automorphism satisfies $f(pg) = f(p)g$. However, $R_h(pg) = pgh \neq R_h(p)g = phg$.

The set of sections of E can be identified as the set of gauge transformations.

As mentioned above, there is a close relationship between cross sections and gauge transformations. Let $\mathcal{S}(E, M, F)$ be the set of all sections of the associated bundle E with base manifold M and standard fiber F .¹ Consider $\mathcal{S}(E, M, G)$ in which G acts on itself via the adjoint transformation: $g \cdot h = ghg^{-1}$.

Theorem 35.1.7 *There is a natural bijection $\mathcal{S}(E, M, G) \cong \text{Gau}(P)$.*

¹Note that particle fields are members of $\mathcal{S}(E, M, \mathcal{V})$.

Proof For $\sigma \in \mathcal{S}(E, M, G)$ define $f : P \rightarrow P$ by $f(p) = p\pi_2 \circ \sigma \circ \pi(p)$, where π_2 projects onto the second factor of $E = P \times_G G$. The composite $\pi_2 \circ \sigma \circ \pi$ assigns to each p its partner in $\llbracket p, h \rrbracket$. If the partner of p is h , then the partner of $p' = pg$ is $h' = g^{-1}hg$.

Suppose that $f(p) = ph$, so that $\pi_2 \circ \sigma \circ \pi(p) = h$, then

$$f(pg) = pg\pi_2 \circ \sigma \circ \pi(pg) = pgh' = pgg^{-1}hg = phg = f(p)g.$$

Hence, $f \in \text{Gau}(P)$. Conversely, suppose that $f \in \text{Gau}(P)$, i.e., that $f(pg) = f(p)g$. Define σ by $f(p) = p\pi_2 \circ \sigma \circ \pi(p)$, and note that, on the one hand, $f(pg) = pg\pi_2 \circ \sigma \circ \pi(pg)$, and on the other hand $f(pg) = p\pi_2 \circ \sigma \circ \pi(p)g$. Therefore

$$g\pi_2 \circ \sigma \circ \pi(pg) = \pi_2 \circ \sigma \circ \pi(p)g \quad \text{or} \quad \pi_2 \circ \sigma \circ \pi(pg) = g^{-1}\pi_2 \circ \sigma \circ \pi(p)g,$$

which is a necessary condition for σ to be well defined: $\sigma(x)$ could be $\llbracket p, h \rrbracket$ or $\llbracket p', h' \rrbracket$ where $p' = pg$ and $h' = g^{-1}hg$ for some $g \in G$. The preceding equation restates this relation. \square

Remark 35.1.1 In the proof of Theorem 35.1.7, we introduced the composite map $\pi_2 \circ \sigma \circ \pi$, which mapped the first factor of $\sigma(x) = \llbracket p, h \rrbracket$ to its second factor. This is the same construction as the one discussed after Example 34.3.2, where π_2 is denoted by p^{-1} . Sometimes it is more convenient to work with this map rather than the section σ . So, if F is a manifold on which G acts on the left, we define a map $\pi_{12} : P \rightarrow F$ with the property $\pi_{12}(pg) = g^{-1} \cdot \pi_{12}(p)$. This property brings the set of sections in a bijective correspondence with the set $\Pi_{12}(P, F)$ of such maps: $\mathcal{S}(E, M, F) \cong \Pi_{12}(P, F)$. When $F = G$, we get the triple isomorphism

π_{12} and $\Pi_{12}(P, F)$ defined

$$\mathcal{S}(E, M, G) \cong \Pi_{12}(P, G) \cong \text{Gau}(P).$$

In particular, any $f \in \text{Gau}(P)$ can be written as $f(p) = p\pi_{12}(p)$ for some $\pi_{12} \in \Pi_{12}(P, G)$.

A gauge transformation transforms the connection 1-form as well. How does the connection 1-form change under a gauge transformation?

Theorem 35.1.8 *If $f \in \text{Gau}(P)$ and ω is a connection 1-form, then $f^*\omega$ is also a connection 1-form.*

Proof We show that $f^*\omega$ satisfies condition (a) of Definition 34.2.1 and leave the proof of condition (b) for the reader. Let $A \in \mathfrak{g}$ and let A^* be its fundamental vector field in P . Then,

$$\begin{aligned} (f^*\omega)A_p^* &= \omega(f_*A_p^*) = \omega\left(\left.\frac{d}{dt}f(p\gamma_A(t))\right|_{t=0}\right) \\ &= \omega\left(\left.\frac{d}{dt}f(p)\gamma_A(t)\right|_{t=0}\right) = \omega(f_*A_{f(p)}^*) = A, \end{aligned}$$

where to go to the second line, we used $f(pg) = f(p)g$. □

Gauge transformations not only map connections to connections, but they also map tensorial forms to tensorial forms.

Proposition 35.1.9 *If $\phi \in \bar{\Lambda}^k(P, \mathcal{V})$ and $f \in \text{Gau}(P)$, then $f^*\phi \in \bar{\Lambda}^k(P, \mathcal{V})$.*

Proof Using the fact that $f \circ R_g = R_g \circ f$, one can show easily that $R_g^*(f^*\phi) = \rho(g^{-1}) \cdot (f^*\phi)$. That ϕ is horizontal follows from the equality $f_*A^* = A^*$ derived in the proof of Theorem 35.1.8. □

Theorem 35.1.8 and Proposition 35.1.9 tell us that gauge transformations send connection 1-forms to connection 1-forms and tensorial forms to tensorial forms. With the help of Remark 35.1.1, we can find explicit formulas for the gauge-transformed forms. Both formulas can be derived once we know how gauge transformations transform vector fields on P .

gauge transformation of
vector fields

Lemma 35.1.10 *Let $f \in \text{Gau}(P)$ and $\pi_{12} \in \Pi_{12}(P, G)$ be related by $f(p) = p\pi_{12}(p)$. For $\mathbf{X} \in T_pP$, we have*

$$f_*(\mathbf{X}) = [L_{\pi_{12}(p)^*}^{-1}\pi_{12*}(\mathbf{X})]_{f(p)}^* + R_{\pi_{12}(p)*}(\mathbf{X}), \tag{35.3}$$

where $[B]_q^*$ denotes the fundamental vector field of $B \in \mathfrak{g}$ at $q \in P$.

Proof Let $\gamma_X(t)$ be the integral curve of \mathbf{X} passing through p (i.e., $\gamma_X(0) = p$). Then

$$\begin{aligned} f_*(\mathbf{X}) &= \left.\frac{d}{dt}f(\gamma_X(t))\right|_{t=0} = \left.\frac{d}{dt}[\gamma_X(t)\pi_{12}(\gamma_X(t))]\right|_{t=0} \\ &= \left.\frac{d}{dt}[p\pi_{12}(\gamma_X(t))]\right|_{t=0} + \left.\frac{d}{dt}[\underbrace{\gamma_X(t)\pi_{12}(p)}_{=R_{\pi_{12}(p)}\gamma_X(t)}]\right|_{t=0}. \end{aligned}$$

The rest of the proof follows from an identical argument leading to Eq. (34.5). We leave the details as an exercise for the reader. □

Using this lemma, we can instantly prove the following theorem:

Theorem 35.1.11 *If $f \in \text{Gau}(P)$ and $\pi_{12} \in \Pi_{12}(P, G)$ are related by $f(p) = p\pi_{12}(p)$, ω is a connection, and $\phi \in \bar{\Lambda}^k(P, \mathcal{V})$, then*

$$f^*(\omega)_p = L_{\pi_{12}(p)^*}^{-1}\pi_{12*}\omega_p + Ad_{\pi_{12}(p)^{-1}}\omega_p \quad \text{and} \quad (f^*\phi)_p = \pi_{12}^{-1} \cdot \phi.$$

Proof For the first equation, apply ω to both sides of the equation of Lemma 35.1.10. For the second equation, recall that $(f^*\phi)(\mathbf{X}_1, \dots, \mathbf{X}_k) = \phi(f_*\mathbf{X}_1, \dots, f_*\mathbf{X}_k)$. Now use the Lemma for each term in the argument, note that ϕ annihilates the first term on the right-hand side of Eq. (35.3), and use the defining property of a tensorial form as given in Definition 34.3.1. \square

35.2 Gauge-Invariant Lagrangians

We have already encountered Lagrangians defined on \mathbb{R}^n , and have seen consequences of their symmetry, i.e., conservation laws. In this section, we want to formulate them on manifolds and impose gauge symmetry on them.

Definition 35.2.1 A **Lagrangian** is a map $L : P \times \mathcal{V} \times T(P) \rightarrow \mathbb{R}$ satisfying

$$L(pg, g^{-1} \cdot v, g^{-1} \cdot \theta_p \circ R_{g^{-1}*}) = L(p, v, \theta_p),$$

for all $p \in P$, $v \in \mathcal{V}$, $\theta_p : T_p(P) \rightarrow \mathcal{V}$, and $g \in G$.

A Lagrangian whose codomain by definition is \mathbb{R} is usually the integral of a Lagrangian density, which is a function on M . In fact, the condition imposed on the Lagrangian in its definition was to ensure that the Lagrangian density is well-defined. The following proposition connects the two.

Proposition 35.2.2 *Given a Lagrangian L , there is a map $\mathcal{L}_0 : \Pi_{12}(P, \mathcal{V}) \rightarrow \mathcal{C}^\infty(M)$ defined by $\mathcal{L}_0(\psi)(x) = L(p, \psi(p), d\psi_p)$ for $x \in M$, $p \in P$ with $\pi(p) = x$, and $\psi \in \Pi_{12}(P, \mathcal{V})$.*

Proof Write $\psi(pg) = g^{-1} \cdot \psi(p)$ (the property that ψ has to obey by Remark 35.1.1) as $\psi \circ R_g = g^{-1} \cdot \psi$ with the differential $d\psi_{pg} \circ R_{g*} \equiv \psi_{pg*} \circ R_{g*} = g^{-1} \cdot d\psi_p$. Now show that $L(pg, \psi(pg), d\psi_{pg}) = L(p, \psi(p), d\psi_p)$, i.e., all points of the fiber $\pi^{-1}(x)$ give the same Lagrangian. \square

A gauge transformation f takes $p \in P$ to $f(p) \in P$ without leaving the fiber in which p is located. This means that there must exist a $g \in G$ such that $f(p) = pg$. Now, we are interested in Lagrangians which are invariant under such a transformation. That is, we want our Lagrangians to obey

$$\begin{aligned} L(f(p), v, \theta_{f(p)}) &= L(p, v, \theta_p) \quad \text{or} \\ L(pg, v, \theta_{pg}) &= L(p, v, \theta_p) \quad \text{for } g \in G. \end{aligned}$$

Using the defining property of L , we can rewrite the second equation as

$$L(pgg^{-1}, g \cdot v, g \cdot \theta_{pg} \circ R_{g*}) = L(p, v, \theta_p).$$

Noting that $\theta_{pg} = \theta_p \circ R_{g^{-1}*}$, we obtain

$$L(p, g \cdot v, g \cdot \theta_p) = L(p, v, \theta_p). \quad (35.4)$$

G-invariant Lagrangian We say a Lagrangian is **G-invariant** if it satisfies this equation. We do not use “gauge-invariant” because Eq. (35.4) does not use f directly. However, noting that $\Pi_{12}(P, \mathcal{V}) = \bar{\Lambda}^0(P, \mathcal{V})$ and the fact that f acts on $\bar{\Lambda}^k(P, \mathcal{V})$ via pull-back, we can investigate the *gauge*-invariance of the Lagrangian density, i.e., we want to see if \mathcal{L}_0 of Proposition 35.2.2 is gauge invariant, i.e., if $\mathcal{L}_0(\boldsymbol{\psi}) = \mathcal{L}_0(f^*\boldsymbol{\psi})$ or

$$\begin{aligned} L(p, \boldsymbol{\psi}(p), d\boldsymbol{\psi}_p) &\stackrel{?}{=} L(p, (f^*\boldsymbol{\psi})(p), (f^*d\boldsymbol{\psi})_p) \\ &= L(p, (f^*\boldsymbol{\psi})(p), d(f^*\boldsymbol{\psi})_p). \end{aligned}$$

If $f \in \text{Gau}(P)$ and $\pi_{12} \in \Pi_{12}(P, G)$ are related by $f(p) = p\pi_{12}(p)$, then by Theorem 35.1.11, we have $f^*\boldsymbol{\psi} = \pi_{12}^{-1} \cdot \boldsymbol{\psi}$ because $\Pi_{12}(P, \mathcal{V}) = \bar{\Lambda}^0(P, \mathcal{V})$. We now compute $d(\pi_{12}^{-1} \cdot \boldsymbol{\psi})$. Let $\gamma_X(t)$ be the flow of \mathbf{X} . Then

$$\begin{aligned} d(\pi_{12}^{-1} \cdot \boldsymbol{\psi})(\mathbf{X}) &= \left. \frac{d}{dt} \pi_{12}^{-1}(\gamma_X(t)) \cdot \boldsymbol{\psi}(\gamma_X(t)) \right|_{t=0} \\ &= \left. \frac{d}{dt} \pi_{12}^{-1}(p) \cdot \boldsymbol{\psi}(\gamma_X(t)) \right|_{t=0} + \left. \frac{d}{dt} \pi_{12}^{-1}(\gamma_X(t)) \cdot \boldsymbol{\psi}(p) \right|_{t=0} \\ &= \pi_{12}^{-1}(p) \cdot \boldsymbol{\psi}_{*p}(\mathbf{X}) + \pi_{12*}^{-1}(\mathbf{X}) \cdot \boldsymbol{\psi}(p). \end{aligned}$$

Therefore,

$$\begin{aligned} \mathcal{L}_0(f^*\boldsymbol{\psi})(x) &= L(p, (f^*\boldsymbol{\psi})(p), d(f^*\boldsymbol{\psi})_p) \\ &= L(p, \pi_{12}^{-1}(p) \cdot \boldsymbol{\psi}(p), \pi_{12}^{-1}(p) \cdot d\boldsymbol{\psi}_p + \pi_{12*}^{-1} \cdot \boldsymbol{\psi}(p)). \end{aligned}$$

Were it not for the extra term in the third argument of L , we would have gauge invariance. However, the presence of $\pi_{12*}^{-1} \cdot \boldsymbol{\psi}(p)$ makes the Lagrangian density, as defined in Proposition 35.2.2, not gauge-invariant.

The very notion of gauge transformation involves a connection 1-form. Yet nowhere in the definition of the Lagrangian or Lagrangian density did we make use of a connection. So, it should come as no surprise to see the failure of invariance of \mathcal{L}_0 under gauge transformations. Since it is the differential term $d\boldsymbol{\psi}$ of L that causes the violation of the invariance, and since we do have a differentiation which naturally incorporates the connection 1-form, it is natural to replace $d\boldsymbol{\psi}$ with $D^\omega\boldsymbol{\psi}$. So, now define a new density,

recipe for gauge invariant Lagrangians

$$\mathcal{L}(\boldsymbol{\psi}, \boldsymbol{\omega})(x) = L(p, \boldsymbol{\psi}(p), D^\omega\boldsymbol{\psi}_p), \tag{35.5}$$

for $x \in M$, $p \in P$ with $\pi(p) = x$, and $\boldsymbol{\psi} \in \Pi_{12}(P, \mathcal{V})$.

Theorem 35.2.3 *If L in Eq. (35.5) is G-invariant, then \mathcal{L} is well-defined and $\mathcal{L}(f^*\boldsymbol{\psi}, f^*\boldsymbol{\omega}) = \mathcal{L}(\boldsymbol{\psi}, \boldsymbol{\omega})$, i.e., \mathcal{L} is gauge-invariant.*

Proof From Proposition 34.3.4, we have $R_g^* D^\omega \psi_{pg} = g^{-1} \cdot D^\omega \psi_p$. This can be rewritten as

$$D^\omega \psi_{pg} \circ R_{g*} = g^{-1} \cdot D^\omega \psi_p \quad \text{or} \quad D^\omega \psi_{pg} = g^{-1} \cdot D^\omega \psi_p \circ R_{g^{-1}*}.$$

Then,

$$\begin{aligned} L(pg, \psi(pg), D^\omega \psi_{pg}) &= L(pg, g^{-1} \cdot \psi(p), g^{-1} \cdot D^\omega \psi_p \circ R_{g^{-1}*}) \\ &= L(p, \psi(p), D^\omega \psi_p), \end{aligned}$$

where in the second equality, we used the defining property of a Lagrangian in Definition 35.2.1. So, \mathcal{L} is well-defined. Now from Theorem 35.1.4 and Eq. (35.2) with $j = 1$ and $k = 0$, we have $D^\omega \psi = d\psi + \omega \cdot \psi$. Using this result, we obtain

$$\begin{aligned} \mathcal{L}(f^* \psi, f^* \omega)(x) &= L(p, (f^* \psi)(p), d(f^* \psi)_p + f^* \omega_p \cdot (f^* \psi)(p)) \\ &= L(p, (f^* \psi)(p), f^*(d\psi_p + \omega_p \cdot \psi(p))) \\ &= L(p, \pi_{12}(p)^{-1} \cdot \psi(p), f^*(D^\omega \psi_p)). \end{aligned}$$

Then the second equation of Theorem 35.1.11 and the fact that L is G -invariant yield

$$\begin{aligned} \mathcal{L}(f^* \psi, f^* \omega)(x) &= L(p, \pi_{12}(p)^{-1} \cdot \psi(p), \pi_{12}(p)^{-1} \cdot D^\omega \psi_p) \\ &= L(p, \psi(p), D^\omega \psi_p) = \mathcal{L}(\psi, \omega)(x), \end{aligned}$$

showing that \mathcal{L} is indeed gauge-invariant. \square

35.3 Construction of Gauge-Invariant Lagrangians

We have defined Lagrangians in terms of $\psi \in \bar{\Lambda}^0(P, \mathcal{V})$ and $D^\omega \psi \in \bar{\Lambda}^1(P, \mathcal{V})$. Since G acts on \mathcal{V} via a representation, $G \rightarrow GL(\mathcal{V})$, the most natural invariants would be in the form of inner products in \mathcal{V} and the restriction of $GL(\mathcal{V})$ to its unitary subgroup $U(\mathcal{V})$, i.e., we assume that the representation is $G \rightarrow U(\mathcal{V})$, in which case we say that the inner product is **G -orthogonal**. We are thus led to defining G -orthogonal inner products on $\psi \in \bar{\Lambda}^k(P, \mathcal{V})$.

G -orthogonal inner product

Let h be a metric in M . Let π^* be the pull-back of $\pi : P \rightarrow M$. Then π^*h is a bilinear form on P . However, it is not an inner product because $\pi^*h(\mathbf{X}, \mathbf{Y}) = h(\pi_*\mathbf{X}, \pi_*\mathbf{Y})$ vanishes for all \mathbf{Y} if \mathbf{X} is a nonzero vertical vector field. Nevertheless, π^*h does become an inner product if the vectors are confined to the horizontal subspace H_p . Since the forms in $\bar{\Lambda}^k(P, \mathcal{V})$ are horizontal, they could be thought of as forms in H_p . In particular, $\bar{\Lambda}^k(P, \mathbb{R})$ could be identified with the regular k -forms $\Lambda^k(M)$ as explained in Remark 34.3.1. This means that the inner product \tilde{h} defined on $\Lambda^k(M)$ as in Eq. (26.52) could be lifted up to a similar inner product on $\bar{\Lambda}^k(P, \mathbb{R})$,

which we denote by \bar{h} . The inner product on $\bar{\Lambda}^k(P, \mathcal{V})$ is then $\widetilde{h\hat{h}}$ as defined in Eq. 26.53. Specifically, if $\boldsymbol{\psi}, \boldsymbol{\phi} \in \bar{\Lambda}^k(P, \mathcal{V})$, $\{\mathbf{e}_i\}_{i=1}^m$ is a basis of \mathcal{V} , $\boldsymbol{\psi} = \sum_{i=1}^m \psi^i \mathbf{e}_i$, $\boldsymbol{\phi} = \sum_{j=1}^m \phi^j \mathbf{e}_j$, and $\hat{h}_{ij} = \hat{h}(\mathbf{e}_i, \mathbf{e}_j)$, then

$$\widetilde{h\hat{h}}(\boldsymbol{\psi}, \boldsymbol{\phi}) = \sum_{i,j=1}^m \hat{h}_{ij} \bar{h}(\psi^i, \phi^j), \tag{35.6}$$

where $\psi^i, \phi^j \in \bar{\Lambda}^k(P, \mathbb{R})$.

All the discussion above can be summarized as

Theorem 35.3.1 *The functions*

$$\widetilde{h\hat{h}} : \Lambda^k(M, \mathcal{V}) \times \Lambda^k(M, \mathcal{V}) \rightarrow \mathcal{C}^\infty(M)$$

$$\widetilde{h\hat{h}} : \bar{\Lambda}^k(P, \mathcal{V}) \times \bar{\Lambda}^k(P, \mathcal{V}) \rightarrow \mathcal{C}^\infty(M),$$

where the second one is given by Eq. (35.6) and the first by a similar expression, are well-defined. Furthermore, if $\boldsymbol{\psi}, \boldsymbol{\phi} \in \bar{\Lambda}^k(P, \mathcal{V})$ and $\sigma : U \rightarrow P$ is a local section, then

$$\widetilde{h\hat{h}}(\sigma^* \boldsymbol{\psi}, \sigma^* \boldsymbol{\phi}) = \widetilde{h\hat{h}}(\boldsymbol{\psi}, \boldsymbol{\phi}).$$

The last statement is a result of the fact that $\bar{h} \approx \pi^* \tilde{h}$ and $\pi_* \sigma_* = \text{id}$.

With an inner product placed on $\bar{\Lambda}^k(P, \mathcal{V})$, we can define the Hodge star operator and a codifferential.

Definition 35.3.2 The **covariant codifferential** $\delta^\omega : \bar{\Lambda}^k(P, \mathcal{V}) \rightarrow \bar{\Lambda}^{k-1}(P, \mathcal{V})$ of $\boldsymbol{\phi} \in \bar{\Lambda}^k(P, \mathcal{V})$ is defined by

$$\delta^\omega \boldsymbol{\phi} = (-1)^{\nu+1} (-1)^{n(k+1)} \bar{*} D^\omega(\bar{*} \boldsymbol{\phi}),$$

where ν is the index of h , $n = \dim M$, and $\bar{*} = \pi^*(*)$, with $*$ the star operator on M .

Theorem 28.6.6 has an exact analog:

$$\int_M \widetilde{h\hat{h}}(D^\omega \boldsymbol{\psi}, \boldsymbol{\phi}) \boldsymbol{\mu} = \int_M \widetilde{h\hat{h}}(\boldsymbol{\psi}, \delta^\omega \boldsymbol{\phi}) \boldsymbol{\mu}, \tag{35.7}$$

where $\boldsymbol{\psi} \in \bar{\Lambda}^k(P, \mathcal{V})$ and $\boldsymbol{\phi} \in \bar{\Lambda}^{k+1}(P, \mathcal{V})$.

Now that we have inner products for various elements of the Lagrangian, we can write a G -invariant Lagrangian as an inner product. The simplest $L(p, v, \boldsymbol{\theta})$ which is G -invariant is

$$L(p, v, \boldsymbol{\theta}) = \widetilde{h\hat{h}}(\boldsymbol{\theta}_h, \boldsymbol{\theta}_h) - m^2 \hat{h}(v, v)$$

where the subscript h means the horizontal component, and the constant m^2 is introduced to match the dimensions of the two terms. This leads to the gauge-invariant Lagrangian density

a simple Lagrangian density for particle fields

$$\mathcal{L}(\boldsymbol{\psi}, \boldsymbol{\omega}) = \widetilde{h\hat{h}}(D^\omega \boldsymbol{\psi}, D^\omega \boldsymbol{\psi}) - m^2 \hat{h}(\boldsymbol{\psi}, \boldsymbol{\psi}). \tag{35.8}$$

We have to add to this a Lagrangian density associated with the connection itself. So, we might try something similar to the preceding expression. However, while the first term is allowed, the second term, the mass term, cannot be present because ω is not a tensorial form. Furthermore, it does not have a horizontal component in the sense of (a) of Proposition 34.3.4. That is why

Box 35.3.3 *A gauge-invariant Lagrangian cannot contain a mass term for the gauge potential.*

If h_G is a metric on G , then the gauge Lagrangian density can be expressed as

gauge Lagrangian density

$$\mathcal{L}_G(\omega) = -\frac{1}{2}\widetilde{h}h_G(D^\omega\omega, D^\omega\omega) = -\frac{1}{2}\widetilde{h}h_G(\Omega^\omega, \Omega^\omega), \quad (35.9)$$

where the minus sign and the factor of $\frac{1}{2}$ make the equations of motion consistent with observation. The total Lagrangian is just the sum of (35.8) and (35.9):

$$\mathcal{L}_{\text{tot}}(\psi, \omega) = \widetilde{h}\hat{h}(D^\omega\psi, D^\omega\psi) - m^2\hat{h}(\psi, \psi) - \frac{1}{2}\widetilde{h}h_G(\Omega^\omega, \Omega^\omega). \quad (35.10)$$

From the Lagrangian density we can obtain the Lagrange's equation by variational method. We use Eq. (33.4) to find the variational derivative. The particle field and connection are stationary if at $t = 0$

$$\frac{d}{dt} \int_M \mathcal{L}(\psi + t\eta, \omega + t\xi)\mu + \frac{d}{dt} \int_M \mathcal{L}_G(\omega + t\xi)\mu = 0, \quad (35.11)$$

where $\eta \in \bar{\Lambda}^0(P, \mathcal{V})$ and $\xi \in \Lambda^1(P, \mathfrak{g})$. The first term gives

$$\frac{d}{dt} \int_M \mathcal{L}(\psi + t\eta, \omega)\mu + \frac{d}{dt} \int_M \mathcal{L}(\psi, \omega + t\xi)\mu, \quad (35.12)$$

whose first term can be written as

$$\begin{aligned} & \frac{d}{dt} \int_M L(p, \psi + t\eta, D^\omega(\psi + t\eta))\mu \\ &= \frac{d}{dt} \int_M L(p, \psi + t\eta, D^\omega(\psi))\mu \\ & \quad + \frac{d}{dt} \int_M L(p, \psi, D^\omega(\psi) + tD^\omega(\eta))\mu \\ &= \int_M \hat{h}(\partial_2 L(p, \psi, D^\omega(\psi)), \eta)\mu \\ & \quad + \int_M \widetilde{h}\hat{h}(\partial_3 L(p, \psi, D^\omega(\psi)), D^\omega(\eta))\mu. \end{aligned}$$

Denote $\partial_2 L(p, \boldsymbol{\psi}, D^\omega(\boldsymbol{\psi}))$ by $\partial L/\partial \boldsymbol{\psi}$ and $\partial_3 L(p, \boldsymbol{\psi}, D^\omega(\boldsymbol{\psi}))$ by $\partial L/\partial(D^\omega \boldsymbol{\psi})$ and use Eq. (35.7) in the second term to obtain

$$\begin{aligned} & \frac{d}{dt} \int_M L(p, \boldsymbol{\psi} + t\boldsymbol{\eta}, D^\omega(\boldsymbol{\psi} + t\boldsymbol{\eta})) \boldsymbol{\mu} \\ &= \int_M \hat{h} \left(\frac{\partial L}{\partial \boldsymbol{\psi}}, \boldsymbol{\eta} \right) \boldsymbol{\mu} + \int_M \hat{h} \left(\delta^\omega \frac{\partial L}{\partial(D^\omega \boldsymbol{\psi})}, \boldsymbol{\eta} \right) \boldsymbol{\mu}, \end{aligned}$$

or

$$\frac{d}{dt} \int_M L(p, \boldsymbol{\psi} + t\boldsymbol{\eta}, D^\omega(\boldsymbol{\psi} + t\boldsymbol{\eta})) \boldsymbol{\mu} = \int_M \hat{h} \left(\delta^\omega \frac{\partial L}{\partial(D^\omega \boldsymbol{\psi})} + \frac{\partial L}{\partial \boldsymbol{\psi}}, \boldsymbol{\eta} \right) \boldsymbol{\mu}. \tag{35.13}$$

Note that it can actually be shown that $\partial L/\partial \boldsymbol{\psi} \in \bar{\Lambda}^0(P, \mathcal{V})$ and $\partial L/\partial(D^\omega \boldsymbol{\psi}) \in \bar{\Lambda}^1(P, \mathcal{V})$. However, the variational calculations above paired these forms with forms of the correct degree. Note also that $\delta^\omega(\partial L/\partial(D^\omega \boldsymbol{\psi})) \in \bar{\Lambda}^0(P, \mathcal{V})$, and it pairs up in \hat{h} .

To calculate the second term of Eq. (35.12), we note from Theorem 35.1.4 that

$$D^{\omega+t\xi}(\boldsymbol{\psi}) = d\boldsymbol{\psi} + \boldsymbol{\omega} \cdot \boldsymbol{\psi} + t\xi \cdot \boldsymbol{\psi} = D^\omega(\boldsymbol{\psi}) + t\xi \cdot \boldsymbol{\psi}.$$

current (or current density) defined Therefore, (at $t = 0$), we have

$$\begin{aligned} \frac{d}{dt} \mathcal{L}(\boldsymbol{\psi}, \boldsymbol{\omega} + t\xi) &= \frac{d}{dt} L(p, \boldsymbol{\psi}(p), D^\omega(\boldsymbol{\psi}) + t\xi \cdot \boldsymbol{\psi}) \\ &= \widetilde{h\hat{h}}(\partial_3 L(p, \boldsymbol{\psi}(p), D^\omega \boldsymbol{\psi}_p), \xi \cdot \boldsymbol{\psi}) \\ &= \widetilde{h\hat{h}} \left(\frac{\partial L}{\partial(D^\omega \boldsymbol{\psi})}, \xi \cdot \boldsymbol{\psi} \right) \equiv \widetilde{h\hat{h}}_G(J^\omega, \xi), \end{aligned} \tag{35.14}$$

where the last line defines the **current density** $J^\omega \in \bar{\Lambda}^1(P, \mathfrak{g})$.

For the second term of Eq. (35.11), we assume a Lagrangian as given by Eq. (35.9) and write $\boldsymbol{\Omega}_t \equiv \boldsymbol{\Omega}^{\omega+t\xi}$. Then (at $t = 0$)

$$\frac{d}{dt} \boldsymbol{\Omega}_t = \frac{d}{dt} \left(d(\boldsymbol{\omega} + t\xi) + \frac{1}{2}[\boldsymbol{\omega} + t\xi, \boldsymbol{\omega} + t\xi] \right) = d\xi + [\boldsymbol{\omega}, \xi] = D^\omega \xi.$$

Hence, (at $t = 0$)

$$\begin{aligned} \frac{d}{dt} \mathcal{L}_G(\boldsymbol{\omega} + t\xi) &= -\frac{1}{2} \frac{d}{dt} \widetilde{h\hat{h}}_G(\boldsymbol{\Omega}_t, \boldsymbol{\Omega}_t) \\ &= -\frac{1}{2} \frac{d}{dt} \widetilde{h\hat{h}}_G(\boldsymbol{\Omega}^\omega, \boldsymbol{\Omega}_t) - \frac{1}{2} \frac{d}{dt} \widetilde{h\hat{h}}_G(\boldsymbol{\Omega}_t, \boldsymbol{\Omega}^\omega) \\ &= -\frac{1}{2} \widetilde{h\hat{h}}_G(\boldsymbol{\Omega}^\omega, D^\omega \xi) - \frac{1}{2} \widetilde{h\hat{h}}_G(D^\omega \xi, \boldsymbol{\Omega}^\omega) \\ &= -\widetilde{h\hat{h}}_G(\boldsymbol{\Omega}^\omega, D^\omega \xi). \end{aligned} \tag{35.15}$$

We now substitute (35.13), (35.14), and (35.15) in Eq. (35.11) to obtain

$$\int_M \hat{h} \left(\delta^\omega \frac{\partial L}{\partial(D^\omega \psi)} + \frac{\partial L}{\partial \psi}, \eta \right) \mu + \int_M \widetilde{h} h_G(J, \xi) \mu - \int_M \widetilde{h} h_G(\Omega^\omega, D^\omega \xi) \mu = 0.$$

Using Eq. (35.7) on the last term, we remove the covariant differentiation from ξ . Then noting that η and ξ are arbitrary and independent of each other, we obtain

Theorem 35.3.4 *The particle field ψ and the connection 1-form ω are stationary relative to the total Lagrangian iff they satisfy the following two Lagrange’s equations:*

$$\begin{aligned} \text{(a)} \quad & \delta^\omega \frac{\partial L}{\partial(D^\omega \psi)} + \frac{\partial L}{\partial \psi} = 0, \\ \text{(b)} \quad & \delta^\omega \Omega^\omega = J^\omega(\psi). \end{aligned}$$

Lagrange’s equations

Let us examine the current J^ω in some more detail. It is common to suppress the superscript ω , although the current depends on the connection. The fact that the current pairs up with $\xi \in \Lambda^1(P, \mathfrak{g})$ tells us that $J \in \Lambda^1(P, \mathfrak{g})$. Denoting $\partial L/\partial(D^\omega \psi)$ by ϕ and letting $\{e_\alpha\}$ and $\{e_i\}$ be bases for \mathfrak{g} and \mathcal{V} , respectively, the last line of Eq. (35.14) can be expressed as

$$\widetilde{h} \hat{h}(\phi^i e_i, \xi^\beta e_\beta \cdot \psi) = \widetilde{h} h_G(J^\alpha e_\alpha, \xi^\beta e_\beta),$$

where summation over repeated indices is understood and J^α , ϕ^i , and ξ^β are real-valued forms. From the definition of the composite inner product, we get

$$\bar{h}(\phi^i \hat{h}(e_i, e_\beta \cdot \psi), \xi^\beta) = \bar{h}(J^\alpha h_G(e_\alpha, e_\beta), \xi^\beta) \equiv h_{G\alpha\beta} \bar{h}(J^\alpha, \xi^\beta),$$

or

$$h_G^{\alpha\beta} \bar{h}(\phi^i \hat{h}(e_i, e_\beta \cdot \psi), \xi^\beta) = \bar{h}(J^\alpha, \xi^\beta).$$

Since this must hold for any ξ^β , we get

$$\begin{aligned} h_G^{\alpha\beta} \phi^i \hat{h}(e_i, e_\beta \cdot \psi) &= J^\alpha, \quad \text{or} \quad J^\alpha = h_G^{\alpha\beta} \hat{h}(\phi, e_\beta \cdot \psi) \quad \text{and} \\ J &= h_G^{\alpha\beta} \hat{h}(\phi, e_\beta \cdot \psi) e_\alpha, \end{aligned}$$

with $J = J^\alpha e_\alpha$. Substituting for ϕ , we finally obtain

formula for current density

$$J^\alpha = h_G^{\alpha\beta} \hat{h} \left(\frac{\partial L}{\partial(D^\omega \psi)}, e_\beta \cdot \psi \right) \quad \text{and} \quad J = h_G^{\alpha\beta} \hat{h} \left(\frac{\partial L}{\partial(D^\omega \psi)}, e_\beta \cdot \psi \right) e_\alpha. \tag{35.16}$$

For the Lagrangian of Eq. (35.10), this simplifies to

$$J^\alpha = 2h_G^{\alpha\beta} \hat{h}(D^\omega \psi, e_\beta \cdot \psi) \quad \text{and} \quad J = 2h_G^{\alpha\beta} \hat{h}(D^\omega \psi, e_\beta \cdot \psi) e_\alpha. \tag{35.17}$$

35.4 Local Equations

In physical applications, potentials and fields are defined on the Minkowski manifold $M = (\mathbb{R}^4, \boldsymbol{\eta})$. Therefore, for our formulas to be useful, we need to pull our equations down to the base manifold M . This is achieved by local sections. So, let $\sigma_u : U \rightarrow P$ be such a section, and use Theorem 35.3.1 to pullback functions and forms from P to M . Then inner products will be defined on M rather than P . In fact, using the equation of Theorem 35.3.1, we can write the Lagrangian of Eq. (35.10) as

$$\begin{aligned} \mathcal{L}_{\text{tot}}(\boldsymbol{\psi}, \boldsymbol{\omega}) &= \widetilde{h}\widehat{h}(\sigma_u^* D^\omega \boldsymbol{\psi}, \sigma_u^* D^\omega \boldsymbol{\psi}) - m^2 \widehat{h}(\sigma_u^* \boldsymbol{\psi}, \sigma_u^* \boldsymbol{\psi}) \\ &\quad - \frac{1}{2} \widetilde{h}\widehat{h}_G(\sigma_u^* \boldsymbol{\Omega}^\omega, \sigma_u^* \boldsymbol{\Omega}^\omega). \end{aligned}$$

As shown in Chap. 34, the result is to substitute local expressions for all quantities. For example, it can be shown easily that $\sigma_u^* D^\omega \boldsymbol{\psi} = D^{\omega u} \boldsymbol{\psi}_u$ where $\boldsymbol{\omega}_u$ is a \mathfrak{g} -valued 1-form and $\boldsymbol{\psi}_u$ a \mathcal{V} -valued function on M . Removing the subscript u , we write the Lagrangian of Eq. (35.10) as

$$\mathcal{L}_{\text{tot}}(\boldsymbol{\psi}, \boldsymbol{\omega}) = \widetilde{h}\widehat{h}(D^\omega \boldsymbol{\psi}, D^\omega \boldsymbol{\psi}) - m^2 \widehat{h}(\boldsymbol{\psi}, \boldsymbol{\psi}) - \frac{1}{2} \widetilde{h}\widehat{h}_G(\boldsymbol{\Omega}^\omega, \boldsymbol{\Omega}^\omega), \quad (35.18)$$

where all quantities are now defined on M . Let $\{\partial_\mu\}$ be a coordinate basis of M , $\{\mathbf{e}_r\}$ a basis of \mathcal{V} , and $\{\mathbf{e}_i\}$ a basis of \mathfrak{g} . Then the Lagrangian can be expressed in terms of components:

$$\begin{aligned} \mathcal{L}_{\text{tot}}(\boldsymbol{\psi}, \boldsymbol{\omega}) &= \widehat{h}_{rs} \widetilde{h}((D^\omega \psi)^r, (D^\omega \psi)^s) - m^2 \widehat{h}_{rs}(\psi^r, \psi^s) \\ &\quad - \frac{1}{2} h_{Gij} \widetilde{h}(\Omega^i, \Omega^j), \end{aligned} \quad (35.19)$$

where we have used Eq. (26.53) and the notation \widetilde{h} is as in Eq. (26.52). Finally, with $h_{\mu\nu} = h(\partial_\mu, \partial_\nu)$ and $h^{\mu\nu}$ the inverse matrix of $h_{\mu\nu}$, and using (26.52), we get

$$\begin{aligned} \mathcal{L}_{\text{tot}}(\boldsymbol{\psi}, \boldsymbol{\omega}) &= \widehat{h}_{rs} h^{\mu\nu} (D^\omega \psi)_\mu^r (D^\omega \psi)_\nu^s \\ &\quad - m^2 \widehat{h}_{rs} \psi^r \psi^s - \frac{1}{4} h_{Gij} h^{\mu\alpha} h^{\nu\beta} \Omega_{\mu\nu}^i \Omega_{\alpha\beta}^j. \end{aligned}$$

It is more common to use g for the metric of M . So, switch h to g and use h for the metric of the Lie group G . Then

$$\begin{aligned} \mathcal{L}_{\text{tot}}(\boldsymbol{\psi}, \boldsymbol{\omega}) &= \widehat{h}_{rs} g^{\mu\nu} ((D^\omega \psi)_\mu^r, (D^\omega \psi)_\nu^s) \\ &\quad - m^2 \widehat{h}_{rs}(\psi^r, \psi^s) - \frac{1}{4} h_{ij} g^{\mu\alpha} g^{\nu\beta} (\Omega_{\mu\nu}^i, \Omega_{\alpha\beta}^j), \end{aligned} \quad (35.20)$$

where (see Problem 35.5)

$$\begin{aligned} (D^\omega \psi)_\mu^r &= \partial_\mu \psi^r + (A_\mu)_s^r \psi^s, \\ \Omega_{\mu\nu}^i &= \partial_\mu A_\nu^i - \partial_\nu A_\mu^i + \frac{1}{2} c_{jk}^i (A_\mu^j A_\nu^k - A_\nu^j A_\mu^k). \end{aligned} \quad (35.21)$$

Note that $\omega = A_\mu dx^\mu$ with A_μ generally a matrix whose elements are functions of space and time. It can be written as $A_\mu = A_\mu^i e_i$ in terms of the basis vectors (matrices) of the Lie algebra.

Example 35.4.1 Let us now look at a specific example. Let $\mathcal{V} = \mathbb{R}^2$ with $h_{rs} = \delta_{rs}$ and G the group of two-dimensional rotations, so that G acts on \mathbb{R}^2 by matrix multiplication. G is an abelian group; so all structure constants are zero. Since G is a one-parameter group, it is one-dimensional, so is its Lie algebra. We have already discussed the Lie algebra of this group in Example 29.1.35, where, if we identify the tangent space of \mathbb{R}^2 as the space itself, we see that the generator of the group is

$$e = \begin{pmatrix} 0 & -1 \\ 1 & 0 \end{pmatrix}$$

which we could also have obtained by differentiating the matrix

$$g(\theta) = \begin{pmatrix} \cos \theta & -\sin \theta \\ \sin \theta & \cos \theta \end{pmatrix}$$

at the identity where $\theta = 0$.

We want to write the Lagrangian (35.20) for this bundle. First we note that

$$\omega = e A_\mu dx^\mu$$

where A_μ is just a function (not a matrix), and it has no i index. The second formula in Eq. (35.21) becomes

$$\Omega_{\mu\nu} = \partial_\mu A_\nu - \partial_\nu A_\mu$$

because the group is abelian. For the first equation of (35.21), we represent ψ as a column vector with two components (remember that r and s run through 1 and 2), and write

$$\begin{aligned} D_\mu^\omega \psi &= \partial_\mu \psi + A_\mu e \psi = \begin{pmatrix} \partial_\mu \psi_1 \\ \partial_\mu \psi_2 \end{pmatrix} + A_\mu \begin{pmatrix} 0 & -1 \\ 1 & 0 \end{pmatrix} \begin{pmatrix} \psi_1 \\ \psi_2 \end{pmatrix} \\ &= \begin{pmatrix} \partial_\mu \psi_1 - A_\mu \psi_2 \\ \partial_\mu \psi_2 + A_\mu \psi_1 \end{pmatrix}. \end{aligned}$$

Then the first term of the Lagrangian becomes

$$\begin{aligned}
& g^{\mu\nu} \left(\partial_\mu \psi_1 - A_\mu \psi_2 \quad \partial_\mu \psi_2 + A_\mu \psi_1 \right) \begin{pmatrix} \partial_\nu \psi_1 - A_\nu \psi_2 \\ \partial_\nu \psi_2 + A_\nu \psi_1 \end{pmatrix} \\
& \equiv g^{\mu\nu} \begin{pmatrix} D_{12\mu}^\psi & D_{21\mu}^\psi \end{pmatrix} \begin{pmatrix} D_{12\nu}^\psi \\ D_{21\nu}^\psi \end{pmatrix} \equiv D_{12\mu}^\psi D_{12}^{\psi\mu} + D_{21\mu}^\psi D_{21}^{\psi\mu} \quad (35.22)
\end{aligned}$$

Putting all the terms together, we obtain

$$\mathcal{L}_{\text{tot}}(\boldsymbol{\psi}, \boldsymbol{\omega}) = D_{12\mu}^\psi D_{12}^\mu + D_{21\mu}^\psi D_{21}^{\psi\mu} - m^2(\psi_1^2 + \psi_2^2) - \frac{1}{4} \Omega_{\mu\nu} \Omega^{\mu\nu} \quad (35.23)$$

with $D_{12\mu}^\psi$ and $D_{21\mu}^\psi$ as defined in (35.22).

It is instructive to find the current of this Lagrangian. Since there is only one component, we do not label it. Then, the first equation in (35.17) becomes

$$J_\mu = 2 \langle D_\mu^\omega \boldsymbol{\psi}, \mathbf{e} \cdot \boldsymbol{\psi} \rangle$$

where the angle brackets designate the inner product in \mathbb{R}^2 . With

$$D_\mu^\omega \boldsymbol{\psi} = \begin{pmatrix} D_{12\mu}^\psi \\ D_{21\mu}^\psi \end{pmatrix} \quad \text{and} \quad \mathbf{e} \cdot \boldsymbol{\psi} = \begin{pmatrix} 0 & -1 \\ 1 & 0 \end{pmatrix} \begin{pmatrix} \psi_1 \\ \psi_2 \end{pmatrix} = \begin{pmatrix} -\psi_2 \\ \psi_1 \end{pmatrix},$$

we get

$$\begin{aligned}
J_\mu &= 2(-\psi_2 D_{12\mu}^\psi + \psi_1 D_{21\mu}^\psi) \\
&= 2[-\psi_2(\partial_\mu \psi_1 - A_\mu \psi_2) + \psi_1(\partial_\mu \psi_2 + A_\mu \psi_1)] \\
&= 2\psi_1 \partial_\mu \psi_2 - 2\psi_2 \partial_\mu \psi_1 + 2A_\mu(\psi_1^2 + \psi_2^2).
\end{aligned}$$

In physics literature, the two components of $\boldsymbol{\psi}$ are considered as the real and imaginary parts of a complex function: $\boldsymbol{\psi} = \psi_1 + i\psi_2$. Then \mathbb{R}^2 is treated as the complex plane \mathbb{C} , and rotation becomes multiplication by the elements of $U(1)$, with which we started this chapter. The equivalence $\mathbf{e} \leftrightarrow i$ between the two methods becomes clear when we note that

$$\begin{pmatrix} 0 & -1 \\ 1 & 0 \end{pmatrix} \begin{pmatrix} 0 & -1 \\ 1 & 0 \end{pmatrix} = - \begin{pmatrix} 1 & 0 \\ 0 & 1 \end{pmatrix} \quad \text{and} \quad \begin{pmatrix} 0 & -1 \\ 1 & 0 \end{pmatrix}^t = - \begin{pmatrix} 0 & -1 \\ 1 & 0 \end{pmatrix},$$

with transposition being equivalent to complex conjugation. The reader is urged to go through the complex treatment as a useful exercise (see Problem 35.6).

At the beginning of the chapter, we identified the principal fiber bundle having $U(1)$ as the structure group with the electromagnetic interaction. In this example, we have included a matter field, a charged scalar field in the model. Therefore, our Lagrangian describes a charged scalar field interacting via electromagnetic force.

35.5 Problems

35.1 Prove condition (b) of Definition 34.2.1 for Theorem 35.1.8. Hint: First show that $f \circ R_g = R_g \circ f$.

35.2 Provide the details of the proof of Lemma 35.1.10.

35.3 Derive Eq. (35.17) from Eq. (35.16).

35.4 For σ_u a local section of M , show that $\sigma_u^* D^\omega \psi = D^{\omega_u} \psi_u$.

35.5 Convince yourself why a factor $\frac{1}{2}$ was necessary for the gauge Lagrangian in going from Eq. (35.19) to Eq. (35.20). Using Eqs. (26.23) and (34.13) show that the components of $\Omega_{\mu\nu}^i$ are as given in (35.21).

35.6 Let $\mathcal{V} = \mathbb{C}$, $G = U(1)$, and write the inner product on \mathbb{C} as

$$\langle z_1, z_2 \rangle = \frac{1}{2}(z_1 \bar{z}_2 + z_2 \bar{z}_1),$$

with bar indicating complex conjugation.

(a) Show that the Lagrangian (35.23) can be written as

$$\mathcal{L} = g^{\mu\nu} (\partial_\mu \psi + i A_\mu \psi) (\partial_\nu \bar{\psi} - i A_\nu \bar{\psi}) - m^2 \bar{\psi} \psi - \frac{1}{4} \Omega^{\mu\nu} \Omega_{\mu\nu}.$$

(b) Show that the current is given by

$$J_\mu = i \bar{\psi} (\partial_\mu \psi + i A_\mu \psi) - i \psi (\partial_\mu \bar{\psi} - i A_\mu \bar{\psi}).$$

(c) Substitute the real and imaginary parts of ψ and show that (a) and (b) reduce to the Lagrangian and current given in Example 35.4.1.

In the last two chapters, we introduced the notions of the principal fiber bundle and its associated bundle. The former made contact with physics by the introduction of a connection—identified as the gauge potential—and its curvature—identified as the gauge field. The latter, the associated bundle with a vector space as its standard fiber, was the convenient setting for particle fields. The concentration of Chap. 35 was on the objects, the particle fields ψ , that lived in the vector space and not on the vector space itself. The importance of the vector space comes from the fact that tangent spaces of the base manifold M are vector spaces, and their examination leads to the nature of the base manifold. And that is our aim in this chapter.

36.1 Connections in a Vector Bundle

Let $P(M, G)$ be a principal fiber bundle and $E(M, \mathbb{R}^m, G, P)$ its associated bundle, where G acts on \mathbb{R}^m by a representation of G into $GL(m, \mathbb{R})$. In such a situation, E is called a **vector bundle**. The set of sections $\mathcal{S}(E, M, \mathbb{R}^m)$ has a natural vector space structure with obvious addition of vectors and multiplication by scalars. Furthermore, if $\lambda \in \mathcal{C}^\infty(M)$, we have

$$(\lambda\varphi)(x) = \lambda(x) \cdot \varphi(x), \quad \varphi \in \mathcal{S}(E, M, \mathbb{R}^m), \quad x \in M.$$

If φ is a section in E , and if φ is to have any physical application, we have to know how to calculate its partial (or directional) derivatives. This means being able to define a differentiation process for φ given a vector field \mathbf{X} on M . For a vector field \mathbf{X} , let $\gamma_{\mathbf{X}}(t)$ be its integral curve in the neighborhood of $t = 0$. Denote this curve by x_t , so that $\mathbf{X} = \dot{x}_0$. Lift this curve up to w_t , and see how φ changes along this curve. The derivative of φ along w_t is what we are after.

Definition 36.1.1 Let φ be a section of E defined on the curve $\gamma = x_t$ in M . Let \dot{x}_t be the vector tangent to γ at x_t . The **covariant derivative** $\nabla_{\dot{x}_t}\varphi$ of φ in the direction of (or with respect to) \dot{x}_t is given by

$$\nabla_{\dot{x}_t}\varphi = \lim_{h \rightarrow 0} \frac{1}{h} [\gamma_i^{t+h}(\varphi(x_{t+h})) - \varphi(x_t)]$$

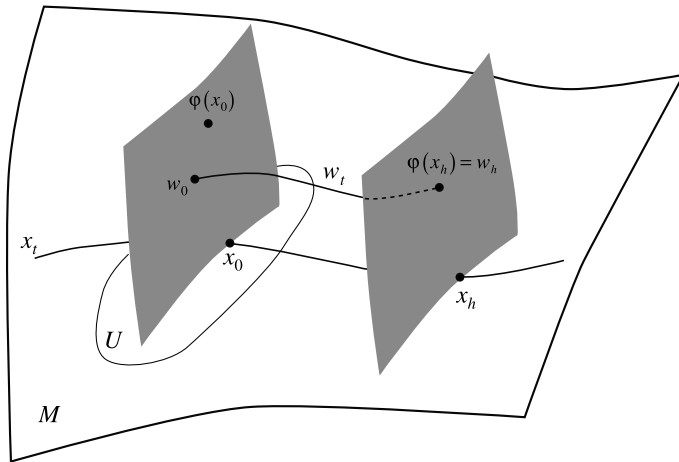

Fig. 36.1 The covariant derivative $\nabla_{\dot{x}_0} \varphi$. The grey sheets are $\pi_E^{-1}(x_0)$ and $\pi_E^{-1}(x_h)$, the fibers of E at x_0 and x_h . Find $\varphi(x_h)$. Construct the horizontal lift w_t of x_t starting at $\varphi(x_h)$. Go backwards to the fiber at x_0 . Record w_0 , and find the difference $\varphi(x_0) - w_0$ and divide by h . As h goes to zero, this ratio gives the covariant derivative of φ with respect to \dot{x}_0

where γ_t^{t+h} is the parallel displacement of the fiber $\pi_E^{-1}(x_{t+h})$ along γ to the fiber $\pi_E^{-1}(x_t)$.

Note that $\nabla_{\dot{x}_t} \varphi \in \pi_E^{-1}(x_t)$, and thus defines a section of E along γ .

Remark 36.1.1 Definition 36.1.1 has a number of interesting features which are worth exploring. First, the very notion of derivative involves a subtraction, an operation that does not exist on all mathematical objects such as, for example, manifold. Thus, the fact that fibers of this particular E have a vector-space structure is important. Second, although all fibers are isomorphic as vector spaces, there is no natural isomorphism connecting them. Parallelism gives an isomorphism, but parallelism depends on the notion of a horizontal lift of a curve in the base manifold. Horizontal lift, in turn, depends on the notion of a connection. One interpretation of the word “connection” is that it actually does connect fibers through an induced isomorphism.

Third, any derivative involves an infinitesimal change. Now that we have a curve in the base manifold, it can induce a section-dependent curve $\varphi(x_t)$ in E . A natural directional derivative of the section would be to move along x_t and see how $\varphi(x_t)$ changes. When t changes to $t + h$, the section changes from $\varphi(x_t)$ to $\varphi(x_{t+h})$. But we cannot compute the difference $\varphi(x_{t+h}) - \varphi(x_t)$, because $\varphi(x_{t+h}) \in \pi_E^{-1}(x_{t+h})$ while $\varphi(x_t) \in \pi_E^{-1}(x_t)$, and we don't know how to subtract two vectors from two different vector spaces. That is why we need to transfer $\varphi(x_{t+h})$ to $\pi_E^{-1}(x_t)$ via the parallelism γ_t^{t+h} (see Fig. 36.1). The word “parallelism” comes about because the horizontal lift of x_t is as parallel to x_t as one can get within the confines of a connection.

Definition 36.1.2 A section φ is **parallel** if $\varphi(x_t)$ is the horizontal lift of x_t . In particular, $\gamma_t^{t+h}(\varphi(x_{t+h})) = \varphi(x_t)$ for all t and h .

We thus have

Proposition 36.1.3 A section φ is parallel iff $\nabla_{\dot{x}_t}\varphi = 0$ for all t .

Furthermore, if we rewrite the defining equation of the covariant derivative as

$$\gamma_t^{t+h}(\varphi(x_{t+h})) = \varphi(x_t) + h\nabla_{\dot{x}_t}\varphi + O(h^2),$$

where $O(h^2)$ denotes terms of order h^2 and higher powers of h , then we see that two curves that have the same value and tangent vector at t give the same covariant derivative at t . This means that we can define the covariant derivative in terms of vectors.

Definition 36.1.4 Let $\mathbf{X} \in T_x M$ and φ a section of E defined on a neighborhood of $x \in M$. Let x_t be a curve such that $\mathbf{X} = \dot{x}_0$. Then the **covariant derivative of φ in the direction of \mathbf{X}** is $\nabla_{\mathbf{X}}\varphi = \nabla_{\dot{x}_0}\varphi$. A section φ is parallel on $U \subset M$ iff $\nabla_{\mathbf{X}}\varphi = 0$ for all $\mathbf{X} \in T_x U$, $x \in U$.

It is convenient to have an alternative definition of the covariant derivative of a section in the direction of the vector \mathbf{X} in terms of its horizontal lift in P .

Proposition 36.1.5 Let φ be defined on $U \subset M$. Associate with φ an \mathbb{R}^m -valued function f on $\pi^{-1}(U) \subset P$ by $f(p) = p^{-1}(\varphi(\pi(p)))$ for $p \in \pi^{-1}(U) \subset P$ as in Remark 34.3.1. Let $\mathbf{X}^* \in T_p P$ be the horizontal lift of $\mathbf{X} \in T_x M$. Then $\mathbf{X}^* f \in \mathbb{R}^m$ and $p(\mathbf{X}^* f) \in \pi^{-1}(x)$, and

$$\nabla_{\mathbf{X}}\varphi = p(\mathbf{X}^* f).$$

Proof Let x_t be the curve with $\dot{x}_0 = \mathbf{X}$. Let p_t be the horizontal lift of x_t such that $\mathbf{X}^* = \dot{p}_0$ and $p_0 = p$. Then we have

$$\mathbf{X}^* f = \lim_{h \rightarrow 0} \frac{1}{h} [f(p_h) - f(p)] = \lim_{h \rightarrow 0} \frac{1}{h} [p_h^{-1}(\varphi(x_h)) - p^{-1}(\varphi(x))]$$

and

$$p\mathbf{X}^* f = \lim_{h \rightarrow 0} \frac{1}{h} [pp_h^{-1}(\varphi(x_h)) - \varphi(x)].$$

Set $\xi = p_h^{-1}(\varphi(x_h))$, and consider $p_t\xi$, which is a horizontal curve in E . Note that $p_h\xi = \varphi(x_h)$ and $p_0\xi = p p_h^{-1}(\varphi(x_h))$. By the definition of γ_0^h , we have $\gamma_0^h(p_h\xi) = p_0\xi$. Hence, $\gamma_0^h\varphi(x_h) = p p_h^{-1}(\varphi(x_h))$. Substituting this in the above equation yields the result we are after. \square

Sometimes it is convenient to write the definition of the covariant derivative in terms of ordinary derivatives, as follows

$$\nabla_{\dot{x}_t}\varphi = \left. \frac{d}{ds}\gamma_t^{t+s}(\varphi(x_{t+s})) \right|_{s=0}. \quad (36.1)$$

The covariant derivative satisfies certain important properties which are sometimes used to define it. We collect these properties in the following

Proposition 36.1.6 *Let $\mathbf{X}, \mathbf{Y} \in T_x M$ and φ and ψ be sections of E defined in a neighborhood of x . Then*

- (a) $\nabla_X(\varphi + \psi) = \nabla_X\varphi + \nabla_X\psi$;
- (b) $\nabla_{\alpha X}\varphi = \alpha\nabla_X\varphi$, where $\alpha \in \mathbb{R}$;
- (c) $\nabla_{X+Y}\varphi = \nabla_X\varphi + \nabla_Y\varphi$;
- (d) $\nabla_X(f\varphi) = f(x) \cdot \nabla_X\varphi + (\mathbf{X}f) \cdot \varphi(x)$, where f is a real-valued function defined in a neighborhood of x .

Proof (a) follows from the fact that the isomorphism γ_t^{t+h} is linear. (b) follow from the fact that if $\gamma_X(t)$ is the curve whose tangent is \mathbf{X} , then $\gamma_X(\alpha t)$ is the curve whose tangent is $\alpha\mathbf{X}$. (c) follows from Proposition 36.1.5 and the fact that $\mathbf{X}^* + \mathbf{Y}^*$ is the lift of $\mathbf{X} + \mathbf{Y}$. For (d), let \mathbf{X} be tangent to x_t with $x_0 = x$ and $\mathbf{X} = \dot{x}_0$. Then use Eq. (36.1):

$$\begin{aligned} \nabla_X(f\varphi) &= \nabla_{\dot{x}_0}(f\varphi) = \left. \frac{d}{dt}\gamma_0^t(f(x_t)\varphi(x_t)) \right|_{t=0} = \left. \frac{d}{dt}f(x_t)\gamma_0^t(\varphi(x_t)) \right|_{t=0} \\ &= \left. \frac{d}{dt}f(x_t)\gamma_0^t(\varphi(x_t)) \right|_{t=0} + \left. \frac{d}{dt}f(x_t)\gamma_0^0(\varphi(x)) \right|_{t=0} \\ &= f(x) \cdot \nabla_X(\varphi) + (\mathbf{X}f) \cdot \varphi(x) \end{aligned}$$

where we used $\gamma_0^t(f(x_t)\varphi(x_t)) = f(x_t)\gamma_0^t(\varphi(x_t))$, which is a property of the linearity of γ_0^t and the fact that $f(x_t)$ is a real number. We also used $\gamma_0^0 = \text{id}$, which should be obvious. \square

Remark 36.1.2 Proposition 36.1.6 applies to vectors at a point of the manifold M . It can be generalized to vector fields by applying it pointwise. Therefore, the proposition holds for vector fields as well. The minor difference is that α in (b) of the proposition can also be a function on M .

36.2 Linear Connections

From the general vector bundles whose standard fiber was \mathbb{R}^m , we now specialize to the bundle of linear frames $L(M)$ examined in Example 34.1.11, among whose associated bundles are tangent bundle (Box 34.1.17) and tensor bundle (Example 34.1.18). We use P for $L(M)$ to avoid cluttering the notations.

Definition 36.2.1 A connection Γ in $L(M) \equiv P$ is called a **linear connection** of M . linear connection

Recall that for any principal fiber bundle and its associate bundle E , each $p \in P$ is an isomorphism of F , the standard fiber of E , with $\pi_E^{-1}(x)$. In fact, p^{-1} is an F -valued map on $\pi_E^{-1}(x)$. In the present case of $L(M)$, p^{-1} is an \mathbb{R}^n -valued map on $T_x M$. In addition, there is a natural map $T_p P \rightarrow T_x M$, namely π_* . If we combine the two maps, we get a 1-form on $L(M)$:

Definition 36.2.2 The **canonical form** θ of $L(M) \equiv P$ is the \mathbb{R}^n -valued 1-form on P defined by canonical form

$$\theta(\mathbf{X}) = p^{-1} \pi_*(\mathbf{X}) \quad \text{for } \mathbf{X} \in T_p P. \tag{36.2}$$

Proposition 36.2.3 *The canonical form is a tensorial 1-form of type $(\text{id}, \mathbb{R}^n)$, where id is the identity representation of $GL(n; \mathbb{R})$.*

Proof Let \mathbf{X} be any vector at $p \in P$ and $g \in GL(n; \mathbb{R})$. Then $R_{g*}\mathbf{X}$ is a vector at $pg \in P$. Therefore,

$$\begin{aligned} (R_g^* \theta)(\mathbf{X}) &= \theta(R_{g*}\mathbf{X}) = (pg)^{-1}(\pi_*(R_{g*}\mathbf{X})) \\ &= g^{-1} p^{-1}(\pi_*(\mathbf{X})) = g^{-1} \cdot \theta(\mathbf{X}), \end{aligned}$$

where we used $\pi_*(R_{g*}\mathbf{X}) = \pi_*(\mathbf{X})$ which is implied by $\pi(pg) = \pi(p)$. This shows that θ is pseudotensorial. But if \mathbf{X} is vertical, then π_* —and therefore θ —annihilates it. Hence, θ is tensorial. □

Definition 36.2.4 Let Γ be a linear connection of M . For each $\xi \in \mathbb{R}^n$ and $p \in P$ define the vector field $\mathbf{B}(\xi)$ in such a way that $(\mathbf{B}(\xi))_p$ is the unique horizontal lift of $p\xi \in T_{\pi(p)}M$. The vector field $\mathbf{B}(\xi)$ so defined is called the **standard horizontal vector field** of Γ corresponding to ξ . standard horizontal vector field of a connection

Proposition 36.2.5 *The standard horizontal vector fields have the following properties:*

- (a) *If θ is the canonical form of P , then $\theta \circ \mathbf{B} = \text{id}_{\mathbb{R}^n}$.*
- (b) *$R_{g*}(\mathbf{B}(\xi)) = \mathbf{B}(g^{-1}\xi)$ for $g \in GL(n; \mathbb{R})$ and $\xi \in \mathbb{R}^n$.*
- (c) *If $\xi \neq 0$, then $\mathbf{B}(\xi)$ never vanishes.*

Proof (a) follows directly from the definition of θ . In fact

$$\theta_p((\mathbf{B}(\xi))_p) = p^{-1}(\pi_*((\mathbf{B}(\xi))_p)) = p^{-1}(p\xi) = \xi.$$

(b) If $\mathbf{B}(\xi)$ is a standard horizontal vector field at p , then $R_{g*}(\mathbf{B}(\xi))$ is a standard horizontal vector field at pg . Let $R_{g*}(\mathbf{B}(\xi)) \equiv \mathbf{B}(\xi')$. Then $\pi_*((\mathbf{B}(\xi'))_{pg}) = pg\xi'$. We also have $\pi_*((\mathbf{B}(\xi))_p) = p\xi$. Since $\pi_*(R_{g*}\mathbf{X}) = \pi_*(\mathbf{X})$, we must have $pg\xi' = p\xi$ or $\xi' = g^{-1}\xi$.

(c) Assume that $(\mathbf{B}(\xi))_p = 0$ for some p . Then $p\xi = \pi_*((\mathbf{B}(\xi))_p) = 0$. Multiplying by p^{-1} , we get $\xi = 0$. □

Proposition 36.2.6 Let A^* be the fundamental vector field corresponding to $A \in \mathfrak{g}$ and $\mathbf{B}(\xi)$ the standard horizontal vector field corresponding to $\xi \in \mathbb{R}^n$. Then

$$[A^*, \mathbf{B}(\xi)] = \mathbf{B}(A\xi).$$

Proof Recall that the commutator of two vector fields is the Lie derivative of one with respect to the other. Hence, using Definition 28.4.12, noting that the action of G on P is a right action, and using (b) of Proposition 36.2.5, we have

$$\begin{aligned} [A^*, \mathbf{B}(\xi)] &= \lim_{t \rightarrow 0} \frac{1}{t} [R_{g_t^*}^{-1} \mathbf{B}(\xi) - \mathbf{B}(\xi)] \\ &= \lim_{t \rightarrow 0} \frac{1}{t} [\mathbf{B}(g_t \xi) - \mathbf{B}(\xi)] = \lim_{t \rightarrow 0} \frac{1}{t} [\mathbf{B}(e^{tA} \xi) - \mathbf{B}(\xi)] \\ &= \lim_{t \rightarrow 0} \frac{1}{t} [\mathbf{B}((1 + tA + \cdots)\xi) - \mathbf{B}(\xi)] = \mathbf{B}(A\xi), \end{aligned}$$

where we used $\exp(tA) = e^{tA}$ when the Lie algebra is $\mathfrak{gl}(n; \mathbb{R})$. \square

Definition 36.2.7 The **torsion form** of a linear connection ω is defined by

torsion form

$$\Theta = D^\omega \theta. \quad (36.3)$$

Proposition 36.2.3 implies that $\Theta \in \bar{A}^2(P, \mathbb{R}^n)$, i.e., that the torsion form is a tensorial 2-form.

Theorem 36.2.8 Let ω , Θ , and Ω be the connection form, the torsion form, and the curvature form of a linear connection Γ of $L(M)$. Then we have,

First structure equation: $\Theta = d\theta + \omega \wedge \theta$, or in detail,

$$\Theta(\mathbf{X}, \mathbf{Y}) = d\theta(\mathbf{X}, \mathbf{Y}) + \omega(\mathbf{X}) \cdot \theta(\mathbf{Y}) - \omega(\mathbf{Y}) \cdot \theta(\mathbf{X})$$

Second structure equation: $\Omega = d\omega + \frac{1}{2}[\omega, \omega]$, or

$$\Omega(\mathbf{X}, \mathbf{Y}) = d\omega(\mathbf{X}, \mathbf{Y}) + \frac{1}{2}[\omega(\mathbf{X}), \omega(\mathbf{Y})],$$

where $\mathbf{X}, \mathbf{Y} \in T_p(L(M))$.

Proof The second structure equation is the result of Theorem 34.3.6. The first structure equation is derived in [Koba 63, pp. 120–121]. \square

The equations above which do not act on vector fields are to be interpreted as products of matrices whose entries are forms and the multiplication is through wedge product. We can write the equations above in terms of components. Let $\{\hat{\mathbf{e}}_i\}_{i=1}^n$ be the standard basis of \mathbb{R}^n and $\{\mathbf{E}_i^j\}_{i,j=1}^n$ be a

basis of $\mathfrak{gl}(n, \mathbb{R})$. \mathbf{E}_i^j is an $n \times n$ matrix with a 1 at the i th column and j th row and zero everywhere else. In terms of these basis vectors, we can write

$$\begin{aligned}\theta &= \theta^i \hat{\mathbf{e}}_i, & \Theta &= \Theta^i \hat{\mathbf{e}}_i, \\ \omega &= \omega_j^i \mathbf{E}_i^j, & \Omega &= \Omega_j^i \mathbf{E}_i^j,\end{aligned}\tag{36.4}$$

with summation over repeated indices in place. Then the structure equations become

$$\begin{aligned}\Theta^i &= d\theta^i + \omega_j^i \wedge \theta^j, & i &= 1, 2, \dots, n, \\ \Omega_j^i &= d\omega_j^i + \omega_k^i \wedge \omega_j^k, & i, j &= 1, 2, \dots, n,\end{aligned}\tag{36.5}$$

as the reader can verify (see Problem 36.2). Multiplying both sides of the second equation above by \mathbf{E}_i^j , the left-hand side becomes a matrix with elements Ω_j^i . The first terms on the right-hand side becomes the exterior derivative of a matrix whose elements are ω_j^i and the second term on the right-hand side will be simply the matrix product of the latter matrix, where the elements are wedge-multiplied. We summarize this in the following box, which we shall use later:

Box 36.2.9 Let $\hat{\Omega}$ be the matrix with elements Ω_j^i and $\hat{\omega}$ the matrix with elements ω_j^i . Then $\hat{\Omega} = d\hat{\omega} + \hat{\omega} \wedge \hat{\omega}$, where d operates on the elements of $\hat{\omega}$ and $\hat{\omega} \wedge \hat{\omega}$ is the multiplication of two matrices in which ordinary product is replaced with wedge product.

Theorem 36.2.10 (Bianchi's identities) Let ω , Θ , and Ω be the connection form, the torsion form, and the curvature form of a linear connection Γ of $L(M)$. Then

$$\begin{aligned}\text{First Bianchi identity: } & D^\omega \Theta = \Omega \wedge \theta. \\ \text{Second Bianchi identity: } & D^\omega \Omega = 0.\end{aligned}$$

Proof The first identity is a special case of Theorem 35.1.4. The second identity was the content of Theorem 34.3.7. \square

36.2.1 Covariant Derivative of Tensor Fields

Up to this point, we have concentrated on the differentiation of forms, whose natural differential is D^ω . We also need to differentiate general tensors in the most “natural” way. As discussed earlier, this natural way is the directional derivative introduced in Proposition 36.1.6. However, instead of derivatives with respect to a vector at a point, we generalize to derivatives in the direction of a vector *field* as pointed out in Remark 36.1.2. When the standard fiber is \mathbb{R}^n , with $n = \dim M$, the associated bundle is the tangent

bundle $T(M)$ whose cross sections are vector fields. We thus restate Proposition 36.1.6 for $L(M)$ with the associated bundle $T(M)$ in the direction of vector fields:

Proposition 36.2.11 *Let \mathbf{X} , \mathbf{Y} , and \mathbf{Z} be vector fields on M . Then*

- (a) $\nabla_X(\mathbf{Y} + \mathbf{Z}) = \nabla_X\mathbf{Y} + \nabla_X\mathbf{Z}$;
- (b) $\nabla_{X+Y}\mathbf{Z} = \nabla_X\mathbf{Z} + \nabla_Y\mathbf{Z}$;
- (c) $\nabla_{fX}\mathbf{Y} = f \cdot \nabla_X\mathbf{Y}$, where $f \in \mathcal{C}^\infty(M)$;
- (d) $\nabla_X(f\mathbf{Y}) = f \cdot \nabla_X\mathbf{Y} + (\mathbf{X}f) \cdot \mathbf{Y}$, where $f \in \mathcal{C}^\infty(M)$.

Any derivative satisfying (a)–(d) of Proposition 36.2.11 is the covariant derivative with respect to a linear connection.

We defined the covariant derivative in terms of parallel displacements along a path in M and obtained the four equations of Proposition 36.2.11. It turns out that

Theorem 36.2.12 *Any derivative which satisfies the four conditions of Proposition 36.2.11 is the covariant derivative with respect to some linear connection.*

If instead of \mathbb{R}^n , we take $\mathcal{T}_s^r(\mathbb{R}^n)$ as the standard basis, the bundle associated with $L(M)$ becomes the tensor bundle $T_s^r(M)$ of type (r, s) over M . Being still a vector bundle, we can define a covariant derivative for it. Now, tensors are products of vector fields and 1-forms, and if we know how the directional derivative acts on vector fields and one forms, we know how it acts on all tensors. Since a 1-form pairs up with a vector field to produce a function, we can also state that if the action of the derivative is known for vector fields and functions, it is known for all tensors. The action of ∇_X on vector fields is given by Proposition 36.2.11. The proposition also includes its action on functions (see Problem 36.3).

Theorem 36.2.13 *Let $\mathcal{T}(M)$ be the algebra of tensor fields (the vector space of tensor fields together with tensor multiplication as the algebra multiplication) on M . Then the covariant differentiation has the following properties:*

- (a) $\nabla_X : \mathcal{T}(M) \rightarrow \mathcal{T}(M)$ is a type-preserving derivation;¹
- (b) ∇_X commutes with contraction;
- (c) $\nabla_X f = \mathbf{X}f$ for every function $f \in \mathcal{C}^\infty(M)$ on M ;
- (d) $\nabla_{X+Y} = \nabla_X + \nabla_Y$
- (e) $\nabla_{fX}\mathbf{T} = f \cdot \nabla_X\mathbf{T}$ for all $f \in \mathcal{C}^\infty(M)$ and $\mathbf{T} \in \mathcal{T}(M)$.

A tensor field \mathbf{T} of type (r, s) can be thought of as a multilinear mapping

$$\mathbf{T} : \underbrace{T(M) \times T(M) \times \cdots \times T(M)}_{s \text{ times Cartesian product}} \rightarrow \mathcal{T}_0^r(M).$$

The s vector fields from the domain of \mathbf{T} fill all the covariant slots, leaving all the r contravariant slots untouched. With this kind of interpretation, we have the following:

¹See Definition 3.4.1.

Definition 36.2.14 Given a tensor field \mathbf{T} of type (r, s) the **covariant differential** $\nabla\mathbf{T}$ of \mathbf{T} is a tensor of type $(r, s + 1)$ given by

$$(\nabla\mathbf{T})(\mathbf{X}_1, \dots, \mathbf{X}_s; \mathbf{X}) = (\nabla_X\mathbf{T})(\mathbf{X}_1, \dots, \mathbf{X}_s), \quad \mathbf{X}_i, \mathbf{X} \in T(M).$$

By a procedure similar to that which led to the Lie derivative (28.36) of a p -form, we can obtain the following formula:

$$\begin{aligned} &(\nabla\mathbf{T})(\mathbf{X}_1, \dots, \mathbf{X}_s; \mathbf{X}) \\ &= \nabla_X(\mathbf{T}(\mathbf{X}_1, \dots, \mathbf{X}_s)) - \sum_{i=1}^s \mathbf{T}(\mathbf{X}_1, \dots, \nabla_X\mathbf{X}_i, \dots, \mathbf{X}_s), \end{aligned} \quad (36.6)$$

where \mathbf{T} is a tensor field of type (r, s) and $\mathbf{X}_i, \mathbf{X} \in T(M)$.

A tensor field \mathbf{T} , as a section of a bundle associated with $L(M)$, is said to be parallel iff $\nabla_X\mathbf{T} = 0$ for all vector fields on M (see Proposition 36.1.3). This leads to

Proposition 36.2.15 *A tensor field \mathbf{T} on M is parallel iff $\nabla\mathbf{T} = 0$.*

36.2.2 From Forms on P to Tensor Fields on M

We have defined two kinds of covariant differentiation: D^ω , which acts on differential forms on P , and ∇ , which acts on the sections of the associated bundle E . In general, there is no natural relation between the two, because the standard fiber \mathbb{R}^m of E has no relation to the structure of P . However, when $P = L(M)$ and the standard fiber is \mathbb{R}^n , the fibers $\pi_E^{-1}(x)$ become T_xM , the tangent spaces of the base manifold of the bundle, which are reachable by π_* . Therefore, we expect some kind of a relationship between the two covariant derivatives. In particular, the two quantities defined in terms of D^ω , namely the torsion and curvature forms, should be related to quantities defined in terms of ∇ .

The torsion form, being an \mathbb{R}^n -valued 2-form on $P = L(M)$, takes two vector fields on P and produces a vector in \mathbb{R}^n , the standard fiber of E . Then, through the action of $p \in P$, this vector can be mapped to a vector in T_xM with $x = \pi(p)$ as in Theorem 34.1.14. This process, in conjunction with Remark 34.3.1 allows us to define a map $\mathbf{T} : T(M) \times T(M) \rightarrow T(M)$. This map is called **torsion tensor field** or just **torsion**, and is defined as follows:

$$\mathbf{T}(\mathbf{X}, \mathbf{Y}) \equiv p(\Theta(\mathbf{X}^*, \mathbf{Y}^*)) \quad \text{for } \mathbf{X}, \mathbf{Y} \in T_xM, \quad (36.7)$$

where p is any point of $L(M)$ such that $\pi(p) = x$, and \mathbf{X}^* and \mathbf{Y}^* are any two vectors of $L(M)$ such that $\pi_*(\mathbf{X}^*) = \mathbf{X}$ and $\pi_*(\mathbf{Y}^*) = \mathbf{Y}$. Remark 34.3.1 ensures that $\mathbf{T}(\mathbf{X}, \mathbf{Y})$ is independent of p , \mathbf{X}^* , and \mathbf{Y}^* . Furthermore, $\mathbf{T}(\mathbf{X}, \mathbf{Y}) = -\mathbf{T}(\mathbf{Y}, \mathbf{X})$, and since it maps $T(M) \times T(M)$ to $T(M)$, it is a skew-symmetric tensor field of type $(1, 2)$.

Similarly, The curvature form, being a $\mathfrak{gl}(n, \mathbb{R})$ -valued 2-form on $P = L(M)$, takes two vector fields on P and produces a matrix in $\mathfrak{gl}(n, \mathbb{R})$. This matrix can act on a vector in \mathbb{R}^n , which can be the inverse map of Theorem 34.1.14 (i.e., the image of a vector in $T_x M$ by p^{-1}), to produce another vector in \mathbb{R}^n . Then, through the action of $p \in P$, this vector can be mapped to a vector in $T_x M$ with $x = \pi(p)$ as in Theorem 34.1.14. This process, in conjunction with Remark 34.3.1 allows us to define a map $T(M) \times T(M) \times T(M) \rightarrow T(M)$. This map is called **curvature tensor field** or just **curvature**, and is defined as follows:

$$\mathbf{R}(\mathbf{X}, \mathbf{Y})\mathbf{Z} \equiv p(\boldsymbol{\Omega}(\mathbf{X}^*, \mathbf{Y}^*)(p^{-1}\mathbf{Z})) \quad \text{for } \mathbf{X}, \mathbf{Y}, \mathbf{Z} \in T_x M. \quad (36.8)$$

It follows that \mathbf{R} is a tensor field of type $(1, 3)$ with the property that $\mathbf{R}(\mathbf{X}, \mathbf{Y}) = -\mathbf{R}(\mathbf{Y}, \mathbf{X})$. Note that $\mathbf{R}(\mathbf{X}, \mathbf{Y})$ is an endomorphism of $T_x M$, and is called the **curvature transformation** of $T_x M$ determined by \mathbf{X} and \mathbf{Y} .

Theorem 36.2.16 *The torsion \mathbf{T} and curvature \mathbf{R} can be expressed in terms of covariant differentiation as follows:*

$$\begin{aligned} \mathbf{T}(\mathbf{X}, \mathbf{Y}) &= \nabla_X \mathbf{Y} - \nabla_Y \mathbf{X} - [\mathbf{X}, \mathbf{Y}] \\ \mathbf{R}(\mathbf{X}, \mathbf{Y})\mathbf{Z} &= [\nabla_X, \nabla_Y]\mathbf{Z} - \nabla_{[\mathbf{X}, \mathbf{Y}]} \mathbf{Z}, \end{aligned}$$

where \mathbf{X} , \mathbf{Y} , and \mathbf{Z} are vector fields on M .

Proof Specialize Proposition 36.1.5 to $L(M)$ and get $(\nabla_X \mathbf{Y})_x = p(\mathbf{X}_p^* f)$ where \mathbf{X}_p^* is the horizontal lift of \mathbf{X} at x . The function f is given by

$$f(p) = p^{-1}(\mathbf{Y}_x) = p^{-1}(\pi_*(\mathbf{Y}_p^*)) \equiv \boldsymbol{\theta}(\mathbf{Y}_p^*), \quad (36.9)$$

where \mathbf{Y}_p^* is the horizontal lift of \mathbf{Y} at x . Thus, we have the identity

$$(\nabla_X \mathbf{Y})_x = p(\mathbf{X}_p^*(\boldsymbol{\theta}(\mathbf{Y}_p^*))). \quad (36.10)$$

From (36.9), we get $p^{-1}(\nabla_X \mathbf{Y})_x = \boldsymbol{\theta}((\nabla_X \mathbf{Y})_p^*)$. From (36.10), we get $p^{-1}(\nabla_X \mathbf{Y})_x = \mathbf{X}_p^*(\boldsymbol{\theta}(\mathbf{Y}_p^*))$. Therefore, we have another useful identity:

$$\boldsymbol{\theta}((\nabla_X \mathbf{Y})_p^*) = \mathbf{X}_p^*(\boldsymbol{\theta}(\mathbf{Y}_p^*)). \quad (36.11)$$

Now use the first structure equation of Theorem 36.2.8 to get $\boldsymbol{\Theta}(\mathbf{X}^*, \mathbf{Y}^*) = d\boldsymbol{\theta}(\mathbf{X}^*, \mathbf{Y}^*)$ because $\boldsymbol{\omega}(\mathbf{X}^*) = 0 = \boldsymbol{\omega}(\mathbf{Y}^*)$ for horizontal \mathbf{X}^* and \mathbf{Y}^* . We therefore have

$$\begin{aligned} \mathbf{T}(\mathbf{X}_x, \mathbf{Y}_x) &= p(\boldsymbol{\Theta}(\mathbf{X}_p^*, \mathbf{Y}_p^*)) = p(d\boldsymbol{\theta}(\mathbf{X}_p^*, \mathbf{Y}_p^*)) \\ &= p(\mathbf{X}_p^*(\boldsymbol{\theta}(\mathbf{Y}_p^*)) - \mathbf{Y}_p^*(\boldsymbol{\theta}(\mathbf{X}_p^*)) - \boldsymbol{\theta}([\mathbf{X}_p^*, \mathbf{Y}_p^*]_p)) \\ &= (\nabla_X \mathbf{Y})_x - (\nabla_Y \mathbf{X})_x - [\mathbf{X}, \mathbf{Y}]_x, \end{aligned}$$

where we used Theorem 28.5.11 and the fact that $\pi_*([\mathbf{X}^*, \mathbf{Y}^*]) = [\mathbf{X}, \mathbf{Y}]$.

To prove the curvature tensor equation, let $p^{-1}\mathbf{Z} = f(p) = \theta(\mathbf{Z}_p^*)$ by (36.9). Then, we have

$$\begin{aligned} \mathbf{R}(\mathbf{X}_x, \mathbf{Y}_x)\mathbf{Z}_x &= p(\boldsymbol{\Omega}(\mathbf{X}_p^*, \mathbf{Y}_p^*)(f(p))) = p(-\boldsymbol{\omega}([\mathbf{X}^*, \mathbf{Y}^*]_p)(f(p))) \\ &= p(-\boldsymbol{\omega}(v[\mathbf{X}^*, \mathbf{Y}^*]_p)(f(p))) = p(-A(f(p))), \end{aligned} \quad (36.12)$$

where we used Eq. (34.12) and the fact that $\boldsymbol{\omega}$ annihilates the horizontal component of the bracket (v stands for the vertical component). In the last step, we used (a) of Definition 34.2.1 and denoted by A the element of the Lie algebra that gives rise to $A_p^* \equiv v[\mathbf{X}^*, \mathbf{Y}^*]_p$. Now we note that

$$\begin{aligned} -A(f(p)) &= \left. \frac{d}{dt} \exp(-At) f(p) \right|_{t=0} = \left. \frac{d}{dt} f(p \exp(At)) \right|_{t=0} = A_p^* f \\ &= v[\mathbf{X}^*, \mathbf{Y}^*]_p f = \mathbf{X}^*(\mathbf{Y}_p^* f) - \mathbf{Y}^*(\mathbf{X}_p^* f) - h[\mathbf{X}^*, \mathbf{Y}^*]_p f \\ &= \mathbf{X}^*(\mathbf{Y}_p^*(\theta(\mathbf{Z}^*))) - \mathbf{Y}^*(\mathbf{X}_p^*(\theta(\mathbf{Z}^*))) - h[\mathbf{X}^*, \mathbf{Y}^*]_p(\theta(\mathbf{Z}^*)). \end{aligned}$$

It now follows that

$$\begin{aligned} \mathbf{R}(\mathbf{X}_x, \mathbf{Y}_x)\mathbf{Z}_x &= p(\mathbf{X}^*(\mathbf{Y}_p^*(\theta(\mathbf{Z}^*))) - \mathbf{Y}^*(\mathbf{X}_p^*(\theta(\mathbf{Z}^*))) - h[\mathbf{X}^*, \mathbf{Y}^*]_p(\theta(\mathbf{Z}^*))) \\ &= p(\mathbf{X}_p^*(\theta((\nabla_Y \mathbf{Z})^*)) - \mathbf{Y}_p^*(\theta((\nabla_X \mathbf{Z})^*)) - h[\mathbf{X}^*, \mathbf{Y}^*]_p(\theta(\mathbf{Z}^*))) \\ &= \nabla_X \nabla_Y \mathbf{Z} - \nabla_Y \nabla_X \mathbf{Z} - \nabla_{[X, Y]} \mathbf{Z}, \end{aligned}$$

where we used (36.11) to go from the first line to the second. \square

We also want to express the Bianchi's identities in terms of tensor fields. We shall confine ourselves to the case where the torsion form is zero. In most physical applications this is indeed the case. So the first identity of Theorem 36.2.10 becomes $0 = \boldsymbol{\Omega} \wedge \theta$. Now let \mathbf{X}^* , \mathbf{Y}^* , and \mathbf{Z}^* be the lifts of \mathbf{X} , \mathbf{Y} , and \mathbf{Z} . Then, it is easily shown that

$$0 = (\boldsymbol{\Omega} \wedge \theta)(\mathbf{X}^*, \mathbf{Y}^*, \mathbf{Z}^*) = \text{Cyc}(\boldsymbol{\Omega}(\mathbf{X}^*, \mathbf{Y}^*)\theta(\mathbf{Z}^*)),$$

where Cyc means taking the sum of the cyclic permutations of the expression in parentheses. From Eq. (36.12) and the discussion before it, we also see that

$$\mathbf{R}(\mathbf{X}, \mathbf{Y})\mathbf{Z} = p(\boldsymbol{\Omega}(\mathbf{X}^*, \mathbf{Y}^*)(\theta(\mathbf{Z}^*))). \quad (36.13)$$

Putting the last two equations together, we obtain

$$\text{Cyc}(\mathbf{R}(\mathbf{X}, \mathbf{Y})\mathbf{Z}) \equiv \mathbf{R}(\mathbf{X}, \mathbf{Y})\mathbf{Z} + \mathbf{R}(\mathbf{Z}, \mathbf{X})\mathbf{Y} + \mathbf{R}(\mathbf{Y}, \mathbf{Z})\mathbf{X} = 0. \quad (36.14)$$

The proof of the second Bianchi's identity is outlined in Problem 36.5.

Theorem 36.2.17 *Let \mathbf{R} be the curvature of a linear connection of M whose torsion is zero. Then for \mathbf{X} , \mathbf{Y} and \mathbf{Z} in $T(M)$, we have*

Bianchi's 1st identity: $\text{Cyc}[\mathbf{R}(\mathbf{X}, \mathbf{Y})\mathbf{Z}] = 0;$
Bianchi's 2nd identity: $\text{Cyc}[\nabla_X \mathbf{R}(\mathbf{Y}, \mathbf{Z})] = 0.$

For the sake of completeness, we give the Bianchi's identities for the case where torsion is not zero and refer the reader to [Koba 63, pp. 135–136] for a proof.

Theorem 36.2.18 *Let \mathbf{R} and \mathbf{T} be, respectively, the curvature and torsion of a linear connection of M . Then for \mathbf{X}, \mathbf{Y} and \mathbf{Z} in $T(M)$, we have*

Bianchi's 1st identity: $\text{Cyc}[\mathbf{R}(\mathbf{X}, \mathbf{Y})\mathbf{Z}] = \text{Cyc}[\mathbf{T}(\mathbf{T}(\mathbf{X}, \mathbf{Y}), \mathbf{Z}) + (\nabla_X \mathbf{T})(\mathbf{Y}, \mathbf{Z})];$
Bianchi's 2nd identity: $\text{Cyc}[\nabla_X \mathbf{R}(\mathbf{Y}, \mathbf{Z}) + \mathbf{R}(\mathbf{T}(\mathbf{X}, \mathbf{Y}), \mathbf{Z})] = 0.$

36.2.3 Component Expressions

Any application of connections and curvatures requires expressing them in local coordinates. So, it is useful to have the components and identities in which they participate in terms of local coordinates. For a linear bundle, the isomorphism $\pi^{-1}(U) \cong U \times GL(n, \mathbb{R})$ suggests a local coordinate system of the form (x_i, X_k^j) , where (x_1, \dots, x_n) is a coordinate system for $U \subset M$ and X_k^j are the elements of a nonsingular $n \times n$ matrix.

Let's start with the canonical 1-form $\theta = \sum_{i=1}^n \theta^i \hat{\mathbf{e}}_i$, with $\hat{\mathbf{e}}_i$ the standard basis of \mathbb{R}^n . The most general coordinate expression for θ^i is

$$\theta^i = a_j^i dx^j + b_k^{ij} dX_j^k, \quad \text{therefore} \quad \theta = (a_j^i dx^j + b_k^{ij} dX_j^k) \hat{\mathbf{e}}_i.$$

By definition, $\theta = p^{-1} \circ \pi_*$, and the presence of π_* annihilates any vertical component of a vector field. This means that $b_k^{ij} = 0$. Now note that as a map $\mathbb{R}^n \rightarrow T_x M$, p , whose local coordinates are (x^i, X_k^j) , sends $\hat{\mathbf{e}}_k$ to $X_k^j \partial_j$, and p^{-1} sends ∂_k to $Y_k^i \hat{\mathbf{e}}_i$, where Y_k^i is the inverse of X_k^j . Hence, $\theta(\partial_k) = Y_k^i \hat{\mathbf{e}}_i$. So, we have

$$Y_k^i \hat{\mathbf{e}}_i = \theta(\partial_k) = (a_j^i dx^j) (\partial_k) = a_j^i dx^j (\partial_k) \hat{\mathbf{e}}_i = a_j^i \delta_k^j \hat{\mathbf{e}}_i = a_k^i \hat{\mathbf{e}}_i.$$

Thus, we have our first result:

$$\theta^i = Y_k^i dx^k, \quad Y_k^i = (X^{-1})_k^i. \quad (36.15)$$

Next, we consider the connection 1-form, $\omega = \omega_j^i \mathbf{E}_i^j$, where ω_j^i are real-valued 1-forms and $\{\mathbf{E}_i^j\}$ form a basis of $\mathfrak{gl}(n, \mathbb{R})$. Write

$$\omega_j^i = a_k^i dX_j^k + b_{jk}^i dx^k$$

and let it act on a fundamental vector field $A_p^* = \frac{d}{dt}(p \exp At)|_{t=0}$. If p is represented by X_β^α , then (with the notation $\partial_\alpha^\beta \equiv \partial/\partial X_\beta^\alpha$)

$$A_p^* = X_\beta^\alpha A_\gamma^\beta \frac{\partial}{\partial X_\gamma^\alpha} = X_\beta^\alpha A_\gamma^\beta \partial_\alpha^\gamma$$

and when ω_j^i acts on A_p^* , it should give A_j^i . So,

$$\begin{aligned} A_j^i &= \omega_j^i(A_p^*) = a_k^i dX_j^k (X_\beta^\alpha A_\gamma^\beta \partial_\alpha^\gamma) + b_{jk}^i dx^k (X_\beta^\alpha A_\gamma^\beta \partial_\alpha^\gamma) \\ &= a_k^i X_\beta^\alpha A_\gamma^\beta dX_j^k (\partial_\alpha^\gamma) = a_k^i X_\beta^\alpha A_\gamma^\beta \delta_\alpha^k \delta_j^\gamma = a_k^i X_\beta^k A_j^\beta. \end{aligned}$$

For the equality to hold for all A_j^i , we must have $a_k^i X_\beta^k = \delta_\beta^i$, i.e., that $a_k^i = Y_k^i$, where Y_k^i is the inverse of X_β^i . So, we write

$$\omega_j^i = Y_k^i dX_j^k + b_{jk}^i dx^k. \quad (36.16)$$

To get more insight into the composition of b_{jk}^i , let us try to find $\nabla_{\partial_j} \partial_i$ using (36.10). To this end, let \mathbf{X}_j^* be the horizontal lift of ∂_j . The general form of \mathbf{X}_j^* is

$$\mathbf{X}_j^* = \lambda_j^i \partial_i + \Lambda_{j\gamma}^\beta \partial_\beta^\gamma.$$

Since $\pi_*(\mathbf{X}_j^*) = \partial_j$ and $\pi_*(\partial_\beta^\gamma) = 0$, we get $\lambda_j^i = \delta_j^i$. Since $\omega(\mathbf{X}_j^*) = 0 = \omega_m^i(\mathbf{X}_j^*)$, we get

$$\begin{aligned} 0 &= \omega_m^i(\mathbf{X}_j^*) = Y_k^i dX_m^k (\Lambda_{j\gamma}^\beta \partial_\beta^\gamma) + b_{mk}^i dx^k (\partial_j) \\ &= Y_k^i \Lambda_{j\gamma}^\beta \delta_\beta^k \delta_m^\gamma + b_{mk}^i \delta_j^k = Y_k^i \Lambda_{jm}^k + b_{mj}^i. \end{aligned}$$

Multiply both sides by X_i^α (and sum over i , of course) to get

$$0 = X_i^\alpha Y_k^i \Lambda_{jm}^k + b_{mj}^i X_i^\alpha = \Lambda_{jm}^\alpha + b_{mj}^i X_i^\alpha \quad \text{or} \quad \Lambda_{jm}^\alpha = -b_{mj}^i X_i^\alpha$$

and

$$\mathbf{X}_j^* = \partial_j - b_{mj}^k X_k^\alpha \partial_\alpha^m. \quad (36.17)$$

With a similar expression for \mathbf{X}_i^* . To use (36.10), we need $\theta(\mathbf{X}_i^*)$, which we can obtain using Eq. (36.15), noting that θ acts only on the horizontal component of \mathbf{X}_i^* :

$$\theta(\mathbf{X}_i^*) = Y_k^\beta dx^k (\partial_i) \hat{\mathbf{e}}_\beta = Y_k^\beta \delta_i^k \hat{\mathbf{e}}_\beta = Y_i^\beta \hat{\mathbf{e}}_\beta.$$

As we apply (36.17) to this expression, we must keep in mind that Y_i^β , being the inverse of X_i^β , is independent of x^j . Therefore, only the second term of (36.17) acts on Y_i^β . Then

$$\begin{aligned} \mathbf{X}_j^*(\theta(\mathbf{X}_i^*)) &= -b_{mj}^k X_k^\alpha \partial_\alpha^m (Y_i^\beta \hat{\mathbf{e}}_\beta) = -b_{mj}^k X_k^\alpha (\partial_\alpha^m Y_i^\beta) \hat{\mathbf{e}}_\beta \\ &= b_{mj}^k X_k^\alpha (Y_i^m Y_\alpha^\beta) \hat{\mathbf{e}}_\beta = b_{mj}^k Y_i^m \hat{\mathbf{e}}_k. \end{aligned}$$

Finally, we apply p on this and use $p\hat{\mathbf{e}}_k = X_k^l \partial_l$ to obtain

$$\nabla_{\partial_j} \partial_i = b_{mj}^k Y_i^m X_k^l \partial_l \equiv \Gamma_{ji}^l \partial_l, \quad (36.18)$$

Riemann-Christoffel symbols where in the last step, we introduced the **Riemann-Christoffel symbols**.² These symbols make sense, because $\nabla_{\partial_j} \partial_i$ is a vector field, which could be expanded in terms of the basis $\{\partial_l\}$. The Riemann-Christoffel symbols are simply the coefficients of the expansion. In terms of these symbols, b_{jk}^i can be written as $b_{jk}^i = \Gamma_{km}^l Y_l^i X_j^m$ and Eq. (36.16) can be expressed as

$$\omega_j^i = Y_k^i (dX_j^k + \Gamma_{lm}^k X_j^m dx^l). \quad (36.19)$$

The Riemann-Christoffel symbols could also be obtained from the connection form. From the 1-form ω on P , we define a local $\mathfrak{gl}(n, \mathbb{R})$ -valued 1-form ω_U on M as follows. At each point x on M let σ be the section sending x to the linear frame $(\partial_1, \dots, \partial_n)$. A general section sends x to $(X_1^i \partial_1, \dots, X_n^i \partial_n)$ or equivalently, it sends x to the point in P with coordinates (x^i, X_k^j) . The particular section we are considering sends x to the point in P with coordinates (x^i, δ_k^j) . Moreover, we define $\omega_U = \sigma^* \omega$. Then ω_U is obtained from Eq. (36.19) by setting $X_j^m = \delta_j^m$, $Y_k^i = \delta_k^i$, and $dX_j^k = 0$. Therefore,

$$(\omega_U)_j^i = \Gamma_{lj}^i dx^l. \quad (36.20)$$

We often omit the subscript U when there is no risk of confusion.

Historical Notes

Elwin Bruno Christoffel (1829–1900) came from a family in the cloth trade. He attended an elementary school in Montjoie (which was renamed Monschau in 1918) but then spent a number of years being tutored at home in languages, mathematics, and classics. He attended secondary schools from 1844 until 1849. At first he studied at the Jesuit gymnasium in Cologne but moved to the Friedrich-Wilhelms Gymnasium in the same town for at least the three final years of his school education. He was awarded the final school certificate with a distinction in 1849. The next year he went to the University of Berlin and studied under a number of distinguished mathematicians, including Dirichlet.

After one year of military service in the Guards Artillery Brigade, he returned to Berlin to study for his doctorate, which was awarded in 1856 with a dissertation on the motion of electricity in homogeneous bodies. His examiners included mathematicians and physicists, Kummer being one of the mathematics examiners.

At this point Christoffel spent three years outside the academic world. He returned to Montjoie, where his mother was in poor health, but read widely from the works of Dirichlet, Riemann, and Cauchy. It has been suggested that this period of academic isolation had a major effect on his personality and on his independent approach towards mathematics. It was during this time that he published his first two papers on numerical integration, in 1858, in which he generalized Gauss's method of quadrature and expressed the polynomials that are involved as a determinant. This is now called Christoffel's theorem.

In 1859 Christoffel took the qualifying examination to become a university teacher and was appointed a lecturer at the University of Berlin. Four years later, he was appointed to a chair at the Polytechnicum in Zurich, filling the post left vacant when Dedekind went



Elwin Bruno Christoffel
1829–1900

²The reader is cautioned about the order of the lower indices, as it is different in different books.

to Brunswick. Christoffel was to have a huge influence on mathematics at the Polytechnicum, setting up an institute for mathematics and the natural sciences there.

In 1868 Christoffel was offered the chair of mathematics at the Gewerbsakademie in Berlin, which is now the University of Technology of Berlin. However, after three years at the Gewerbsakademie in Berlin, Christoffel moved to the University of Strasbourg as the chair of mathematics, a post he held until he was forced to retire due to ill health in 1892.

Some of Christoffel’s early work was on conformal mappings of a simply connected region bounded by polygons onto a circle. He also wrote important papers that contributed to the development of the tensor calculus of Gregorio Ricci-Curbastro and Tullio Levi-Civita. The Christoffel symbols that he introduced are fundamental in the study of tensor analysis. The Christoffel reduction theorem, so named by Klein, solves the local equivalence problem for two quadratic differential forms. The procedure Christoffel employed in his solution of the equivalence problem is what Ricci later called *covariant differentiation*; Christoffel also used the latter concept to define the basic Riemann–Christoffel *curvature tensor*. His approach allowed Ricci and Levi–Civita to develop a coordinate-free differential calculus which Einstein, with the help of Grossmann, turned into the tensor analysis, the mathematical foundation of general relativity.

The Riemann–Christoffel symbols are functions of local coordinates. A change of coordinates transforms the symbols according to a rule that can be easily worked out. In fact, if \bar{x}^α is the new coordinates and $\bar{\Gamma}^\alpha_{\beta\gamma}$ is the symbols in the new coordinate system, then $\nabla_{\bar{\partial}_\beta} \bar{\partial}_\gamma = \bar{\Gamma}^\alpha_{\beta\gamma} \bar{\partial}_\alpha$. To find $\bar{\Gamma}^\alpha_{\beta\gamma}$ in terms of the old symbols, substitute $(\bar{\partial}_\alpha x^i) \partial_i$ for $\bar{\partial}_\alpha$, etc.,

$$\nabla_{\frac{\partial x^i}{\partial \bar{x}^\beta} \partial_i} \left(\frac{\partial x^j}{\partial \bar{x}^\gamma} \partial_j \right) = \bar{\Gamma}^\alpha_{\beta\gamma} \frac{\partial x^k}{\partial \bar{x}^\alpha} \partial_k,$$

then use Proposition 36.2.11 to expand the left-hand side. After some simple manipulation, which we leave for the reader, we obtain

$$\bar{\Gamma}^\alpha_{\beta\gamma} = \Gamma^i_{jk} \frac{\partial x^j}{\partial \bar{x}^\beta} \frac{\partial x^k}{\partial \bar{x}^\gamma} \frac{\partial \bar{x}^\alpha}{\partial x^i} + \frac{\partial^2 x^i}{\partial \bar{x}^\beta \partial \bar{x}^\gamma} \frac{\partial \bar{x}^\alpha}{\partial x^i} \tag{36.21}$$

Because of the presence of the second term, Riemann–Christoffel symbols are *not* components of a tensor.

From the definition of the Riemann–Christoffel symbols, the components of a connection form, we deduced their transformation properties. It turns out that

Theorem 36.2.19 *A set of functions Γ^i_{jk} , which transform according to Eq. (36.21) under a change of coordinates, define a unique connection whose components with respect to the coordinates $\{x^i\}$ are Γ^i_{jk} . Furthermore, the connection form $\omega = \omega^i_j \mathbf{E}_i^j$ is given in terms of the local coordinate system by*

$$\omega^i_j = Y_k^i (dX_j^k + \Gamma_{lm}^k X_j^m dx^l)$$

Proof See [Koba 63, pp. 142–143]. □

Define the components of torsion and curvature tensors by

$$\mathbf{T}(\partial_i, \partial_j) = T_{ij}^k \partial_k, \quad \mathbf{R}(\partial_i, \partial_j) \partial_k = R_{kij}^l \partial_l. \tag{36.22}$$

Then, using Theorem 36.2.16 one can easily obtain the following

Box 36.2.20 *The components of torsion and curvature tensors are given in terms of the Christoffel symbols:*

$$\begin{aligned} T_{ij}^k &= \Gamma_{ij}^k - \Gamma_{ji}^k \\ R_{jkl}^i &= \partial_k \Gamma_{lj}^i - \partial_l \Gamma_{kj}^i + \Gamma_{lj}^m \Gamma_{km}^i - \Gamma_{kj}^m \Gamma_{lm}^i. \end{aligned} \quad (36.23)$$

In particular, $\Gamma_{ji}^k = \Gamma_{ij}^k$ if the torsion tensor vanishes.

Equation (36.20) pulls down the connection 1-form from P to M . One can pull down the curvature 2-form as well. Then Eq. (36.5) gives

$$(\Omega_U)^i_j = d(\omega_U)^i_j + (\omega_U)^i_k \wedge (\omega_U)^k_j. \quad (36.24)$$

As indicated above, we often omit the subscript U . Problem 36.11 shows that

$$\Omega_j^i = \frac{1}{2} R_{jkl}^i dx^k \wedge dx^l \quad (36.25)$$

where R_{jkl}^i is as given in Eq. (36.23).

36.2.4 General Basis

The coordinate expressions derived above express the components of forms and fields in a coordinate basis. We need not confine ourselves to coordinate bases. In fact, they are not always the most convenient bases to use. We can work in a basis $\{\mathbf{e}_i\}$ and its dual $\{\epsilon^j\}$. Then the Riemann-Christoffel symbols are defined as

$$\nabla_{\mathbf{e}_i} \mathbf{e}_j = \mathbf{e}_k \Gamma_{ij}^k. \quad (36.26)$$

It has to be emphasized that, even in the absence of torsion, in a general basis, $\Gamma_{ij}^k \neq \Gamma_{ji}^k$. Only in a coordinate basis does this symmetry hold.

Example 36.2.21 Consider two bases $\{\mathbf{e}_i\}$ and $\{\mathbf{e}_{i'}\}$. Write the primed basis in terms of the other: $\mathbf{e}_{i'} = R^j_{i'} \mathbf{e}_j$. Then

$$\begin{aligned} \mathbf{e}_{k'} \Gamma^{k'}_{i'j'} &\equiv \nabla_{\mathbf{e}_{i'}} \mathbf{e}_{j'} = \nabla_{R^l_{i'} \mathbf{e}_l} (R^j_{j'} \mathbf{e}_j) = R^l_{i'} \nabla_{\mathbf{e}_l} (R^j_{j'} \mathbf{e}_j) \\ &= R^l_{i'} \{ R^j_{j'} \nabla_{\mathbf{e}_l} (\mathbf{e}_j) + \nabla_{\mathbf{e}_l} (R^j_{j'}) \mathbf{e}_j \} \\ &= R^l_{i'} R^j_{j'} \mathbf{e}_m \Gamma^m_{lj} + R^l_{i'} \underbrace{\mathbf{e}_l (R^m_{j'})}_{\equiv R^m_{j',l}} \mathbf{e}_m. \end{aligned}$$

Connection coefficients are not tensors! Writing $\mathbf{e}_{k'} = R^m_{k'} \mathbf{e}_m$ on the LHS, equating the components on both sides, and multiplying both sides by the inverse of the transformation matrix R , we

obtain

$$\Gamma^{k'}_{i'j'} = \underbrace{R^{k'}_m R^l_{i'} R^j_{j'} \Gamma^m_{lj}}_{\text{how a (1,2)-tensor transforms}} + \underbrace{R^{k'}_m R^l_{i'} R^m_{j'l}}_{\text{nontensorial term}}, \tag{36.27}$$

where $R^{k'}_m \equiv (R^{-1})^{k'm}$. Equation (36.27) shows once again that the connection coefficients *are not tensors*. Equation (36.21) is a special case of (36.27).

Applying $\nabla_{\mathbf{e}_i}$ to both sides of $\delta^j_m = \langle \mathbf{e}_m, \boldsymbol{\epsilon}^j \rangle$, we obtain

$$\nabla_{\mathbf{e}_i} \boldsymbol{\epsilon}^j = -\Gamma^j_{ik} \boldsymbol{\epsilon}^k. \tag{36.28}$$

Since an arbitrary tensor of a given kind can be expressed as a linear combination of tensor product of vectors and 1-forms, Eqs. (36.26) and (36.28), plus the assumed derivation property of $\nabla_{\mathbf{u}}$, is sufficient to uniquely define the action of $\nabla_{\mathbf{u}}$ on any tensor and for any vector field \mathbf{u} .

Let \mathbf{T} be a tensor of type (r, s) . The covariant differential of Definition 36.2.14, $\nabla : T^r_s(M) \rightarrow T^r_{s+1}(M)$, which is sometimes called the generalized **gradient operator**, when acting on \mathbf{T} , adds an extra lower index. In what follows, we want to find the components of $\nabla \mathbf{T}$ in terms of the components of \mathbf{T} . If

gradient operator for tensors

$$\mathbf{T} = T^{i_1 \dots i_r}_{j_1 \dots j_s} \mathbf{e}_{i_1} \otimes \dots \otimes \mathbf{e}_{i_r} \otimes \boldsymbol{\epsilon}^{j_1} \otimes \dots \otimes \boldsymbol{\epsilon}^{j_s},$$

then, following the customary practice of putting the extra lower index after a semicolon, we write

significance of semicolon in components of the covariant derivative of a tensor

$$\nabla \mathbf{T} \equiv T^{i_1 \dots i_r}_{j_1 \dots j_s; k} \mathbf{e}_{i_1} \otimes \dots \otimes \mathbf{e}_{i_r} \otimes \boldsymbol{\epsilon}^{j_1} \otimes \dots \otimes \boldsymbol{\epsilon}^{j_s} \otimes \boldsymbol{\epsilon}^k, \tag{36.29}$$

and, with $\mathbf{u} = u^k \mathbf{e}_k$,

$$\nabla_{\mathbf{u}} \mathbf{T} = T^{i_1 \dots i_r}_{j_1 \dots j_s; k} u^k \mathbf{e}_{i_1} \otimes \dots \otimes \mathbf{e}_{i_r} \otimes \boldsymbol{\epsilon}^{j_1} \otimes \dots \otimes \boldsymbol{\epsilon}^{j_s}. \tag{36.30}$$

Using these relations, we can calculate the components of the covariant derivative of a general tensor. It is clear that if we use \mathbf{e}_k instead of \mathbf{u} , we obtain the k th component of the covariant derivative. So, on the one hand, we have

$$\nabla_{\mathbf{e}_k} \mathbf{T} = T^{i_1 \dots i_r}_{j_1 \dots j_s; k} \mathbf{e}_{i_1} \otimes \dots \otimes \mathbf{e}_{i_r} \otimes \boldsymbol{\epsilon}^{j_1} \otimes \dots \otimes \boldsymbol{\epsilon}^{j_s}, \tag{36.31}$$

and on the other hand,

$$\begin{aligned} \nabla_{\mathbf{e}_k} \mathbf{T} &= \nabla_{\mathbf{e}_k} (T^{i_1 \dots i_r}_{j_1 \dots j_s} \mathbf{e}_{i_1} \otimes \dots \otimes \mathbf{e}_{i_r} \otimes \boldsymbol{\epsilon}^{j_1} \otimes \dots \otimes \boldsymbol{\epsilon}^{j_s}) \\ &= T^{i_1 \dots i_r}_{j_1 \dots j_s, k} \mathbf{e}_{i_1} \otimes \dots \otimes \mathbf{e}_{i_r} \otimes \boldsymbol{\epsilon}^{j_1} \otimes \dots \otimes \boldsymbol{\epsilon}^{j_s} \\ &\quad + T^{i_1 \dots i_r}_{j_1 \dots j_s} \sum_{m=1}^r \mathbf{e}_{i_1} \otimes \dots \otimes \underbrace{\nabla_{\mathbf{e}_k} \mathbf{e}_{i_m}}_{\mathbf{e}_n \Gamma^n_{kim}} \otimes \dots \otimes \mathbf{e}_{i_r} \otimes \boldsymbol{\epsilon}^{j_1} \otimes \dots \otimes \boldsymbol{\epsilon}^{j_s} \end{aligned}$$

$$+ T_{j_1 \dots j_s}^{i_1 \dots i_r} \sum_{m=1}^s \mathbf{e}_{i_1} \otimes \dots \otimes \mathbf{e}_{i_r} \otimes \boldsymbol{\epsilon}^{j_1} \otimes \dots \otimes \underbrace{\nabla_{\mathbf{e}_k} \boldsymbol{\epsilon}^{j_m}}_{-\Gamma_{kn}^{j_m} \boldsymbol{\epsilon}^n} \dots \otimes \boldsymbol{\epsilon}^{j_s}, \quad (36.32)$$

where $T_{j_1 \dots j_s}^{i_1 \dots i_r} \equiv \mathbf{e}_k(T_{j_1 \dots j_s}^{i_1 \dots i_r})$. Equating the components of Eqs. (36.31) and (36.32) yields components of the covariant derivative of a tensor

$$T_{j_1 \dots j_s; k}^{i_1 \dots i_r} = T_{j_1 \dots j_s, k}^{i_1 \dots i_r} + \sum_{m=1}^r T_{j_1 \dots j_{m-1} j_{m+1} \dots j_s}^{i_1 \dots i_{m-1} i_{m+1} \dots i_r} \Gamma_{kn}^{i_m} - \sum_{m=1}^s T_{j_1 \dots j_{m-1} j_{m+1} \dots j_s}^{i_1 \dots i_{m-1} i_m i_{m+1} \dots i_r} \Gamma_{kjm}^n, \quad (36.33)$$

where only the sum over the subindex m has been explicitly displayed; the (hidden) sum over repeated indices is, as always, understood. Equation (36.33) is (36.6) written in terms of components.

If \mathbf{u} happens to be tangent to a curve $t \mapsto \gamma(t)$, Eq. (36.30) is written as

$$\nabla_{\mathbf{u}} \mathbf{T} = \frac{DT_{j_1 \dots j_s}^{i_1 \dots i_r}}{dt} \mathbf{e}_{i_1} \otimes \dots \otimes \mathbf{e}_{i_r} \otimes \boldsymbol{\epsilon}^{j_1} \otimes \dots \otimes \boldsymbol{\epsilon}^{j_s}, \quad (36.34)$$

where $DT_{j_1 \dots j_s}^{i_1 \dots i_r}/dt \equiv T_{j_1 \dots j_s; k}^{i_1 \dots i_r} u^k$. In a coordinate frame, with $u^i = \dot{x}^i = dx^i/dt$, Eqs. (36.30) and (36.33) give

$$\begin{aligned} \frac{DT_{j_1 \dots j_s}^{i_1 \dots i_r}}{dt} &= T_{j_1 \dots j_s; k}^{i_1 \dots i_r} \frac{dx^k}{dt} = \frac{dT_{j_1 \dots j_s}^{i_1 \dots i_r}}{dt} + \sum_{m=1}^r T_{j_1 \dots j_{m-1} j_{m+1} \dots j_s}^{i_1 \dots i_{m-1} i_{m+1} \dots i_r} \Gamma_{kn}^{i_m} \frac{dx^k}{dt} \\ &\quad - \sum_{m=1}^s T_{j_1 \dots j_{m-1} j_{m+1} \dots j_s}^{i_1 \dots i_{m-1} i_m i_{m+1} \dots i_r} \Gamma_{kjm}^n \frac{dx^k}{dt} \end{aligned} \quad (36.35)$$

For the case of a vector (36.35) becomes

$$\frac{Dv^k}{dt} = \frac{dv^k}{dt} + v^j \Gamma_{ij}^k \frac{dx^i}{dt}. \quad (36.36)$$

This is an important equation, to which we shall return shortly.

With the generalized gradient operator defined, we can construct the divergence of a tensor just as in vector analysis. Given a vector, the divergence operator $\nabla \cdot$ acts on it and gives a scalar, or, in the language of tensor analysis, it lowers the upper indices by 1. This takes place by differentiating components and contracting the upper index with the newly introduced index of differentiation. The divergence of an arbitrary tensor is defined in precisely the same way:

Definition 36.2.22 Given a tensor field \mathbf{T} , define its **divergence** $\nabla \cdot \mathbf{T}$ to be the tensor obtained from $\nabla \mathbf{T}$ by contracting the last upper index with the covariant derivative index. In components,

$$(\nabla \cdot \mathbf{T})_{j_1 \dots j_s}^{i_1 \dots i_{r-1}} = T_{j_1 \dots j_s; k}^{i_1 \dots i_{r-1} k}.$$

Example 36.2.23 There is a useful relation between the covariant and the Lie derivative that we derive now. First, let \mathbf{T} be of type $(2, 0)$ and write it in some frame as $\mathbf{T} = T^{ij} \mathbf{e}_i \otimes \mathbf{e}_j$. Apply the covariant derivative with respect to \mathbf{u} to both sides to obtain

$$\nabla_{\mathbf{u}} \mathbf{T} = \mathbf{u}(T^{ij}) \mathbf{e}_i \otimes \mathbf{e}_j + T^{ij} (\nabla_{\mathbf{u}} \mathbf{e}_i) \otimes \mathbf{e}_j + T^{ij} \mathbf{e}_i \otimes (\nabla_{\mathbf{u}} \mathbf{e}_j).$$

Similarly,

$$L_{\mathbf{u}} \mathbf{T} = \mathbf{u}(T^{ij}) \mathbf{e}_i \otimes \mathbf{e}_j + T^{ij} (L_{\mathbf{u}} \mathbf{e}_i) \otimes \mathbf{e}_j + T^{ij} \mathbf{e}_i \otimes (L_{\mathbf{u}} \mathbf{e}_j).$$

Now use $L_{\mathbf{u}} \mathbf{e}_j = [\mathbf{u}, \mathbf{e}_j] = \nabla_{\mathbf{u}} \mathbf{e}_j - \nabla_{\mathbf{e}_j} \mathbf{u}$ to get

$$L_{\mathbf{u}} \mathbf{T} = \nabla_{\mathbf{u}} \mathbf{T} - T^{ij} [(\nabla_{\mathbf{e}_i} \mathbf{u}) \otimes \mathbf{e}_j + \mathbf{e}_i \otimes (\nabla_{\mathbf{e}_j} \mathbf{u})]. \quad (36.37)$$

On the other hand, if we apply $\nabla_{\mathbf{u}}$ and $L_{\mathbf{u}}$ to both sides of $\delta_j^i = \langle \mathbf{e}^i, \mathbf{e}_j \rangle$ and use $[\mathbf{u}, \mathbf{e}_j] = \nabla_{\mathbf{u}} \mathbf{e}_j - \nabla_{\mathbf{e}_j} \mathbf{u}$, we obtain

$$\nabla_{\mathbf{u}} \mathbf{e}^i = L_{\mathbf{u}} \mathbf{e}^i - (\nabla_{\mathbf{e}_j} \mathbf{u})^i \mathbf{e}^j.$$

It follows that for $\mathbf{T} = T_{ij} \mathbf{e}^i \otimes \mathbf{e}^j$, we have

$$L_{\mathbf{u}} \mathbf{T} = \nabla_{\mathbf{u}} \mathbf{T} + T_{ij} [(\nabla_{\mathbf{e}_k} \mathbf{u})^i \mathbf{e}^k \otimes \mathbf{e}^j + (\nabla_{\mathbf{e}_k} \mathbf{u})^j \mathbf{e}^i \otimes \mathbf{e}^k]. \quad (36.38)$$

One can use Eqs. (36.37) and (36.38) to generalize to a tensor of type (r, s) .

Example 36.2.24 Let f be a function on M . Then ∇f is a one form. Call it ϕ . In a local coordinate system, it can be written as $\phi = \phi_i dx^i$, where

$$\phi_i = \phi(\partial_i) = \nabla f(\partial_i) = \nabla_{\partial_i} f = \partial_i f \equiv \frac{\partial f}{\partial x^i}.$$

Noting that $(\nabla f)_i \equiv f_{;i}$, $\nabla f = f_{;i} dx^i$, and $(\nabla^2 f)_{ij} = f_{;ij}$, let us first find the covariant derivative of ϕ . $\nabla \phi$ is a 2-form, whose components can be found as follows:

$$\begin{aligned} (\nabla \phi)_{ij} &= \nabla \phi(\partial_i, \partial_j) = \nabla_{\partial_j}(\phi(\partial_i)) - \phi(\nabla_{\partial_i} \partial_j) \\ &= \partial_j(\phi_i) - \phi(\Gamma^k_{ij} \partial_k) = \partial_j(\partial_i f) - \Gamma^k_{ij} \phi_k \\ &= \frac{\partial^2 f}{\partial x^j \partial x^i} - \Gamma^k_{ij} \partial_k f = \frac{\partial^2 f}{\partial x^j \partial x^i} - \Gamma^k_{ij} \frac{\partial f}{\partial x^k}, \end{aligned}$$

derivation of the relation between the Lie and the covariant derivatives

where we used Eq. (36.6). We rewrite this as

$$f_{;ij} = \frac{\partial^2 f}{\partial x^j \partial x^i} - \Gamma^k_{ij} \frac{\partial f}{\partial x^k}. \quad (36.39)$$

Reversing the order of indices, we get

$$f_{;ji} = \frac{\partial^2 f}{\partial x^i \partial x^j} - \Gamma^k_{ji} \frac{\partial f}{\partial x^k}. \quad (36.40)$$

Subtracting (36.39) from (36.40) and using (36.23), we obtain

$$f_{;ij} - f_{;ji} = (\Gamma^k_{ij} - \Gamma^k_{ji}) \frac{\partial f}{\partial x^k} = T^k_{ij} \partial_k f. \quad (36.41)$$

Thus, only if the torsion tensor vanishes are the mixed “partial” covariant derivatives equal.

Now we want to find the difference between the mixed second “partial” covariant derivatives of a vector field $\mathbf{Z} = \xi^k \partial_k$. It is more instructive to use general vectors and then specialize to coordinate vector fields. We are thus interested in $\nabla^2 \mathbf{Z}(\mathbf{Y}, \mathbf{X}) - \nabla^2 \mathbf{Z}(\mathbf{X}, \mathbf{Y})$. Let $\psi \equiv \nabla \mathbf{Z}$. From Eq. (36.6), we have

$$\begin{aligned} \nabla \psi(\mathbf{X}, \mathbf{Y}) &= \nabla_Y(\psi(\mathbf{X})) - \psi(\nabla_Y \mathbf{X}) \\ &= \nabla_Y(\nabla \mathbf{Z}(\mathbf{X})) - \nabla \mathbf{Z}(\nabla_Y \mathbf{X}) \\ &= \nabla_Y \nabla_X \mathbf{Z} - \nabla_{\nabla_Y \mathbf{X}} \mathbf{Z}. \end{aligned}$$

Switching \mathbf{X} and \mathbf{Y} and subtracting, we get

$$\begin{aligned} \nabla^2 \mathbf{Z}(\mathbf{Y}, \mathbf{X}) - \nabla^2 \mathbf{Z}(\mathbf{X}, \mathbf{Y}) &= \nabla_X \nabla_Y \mathbf{Z} - \nabla_Y \nabla_X \mathbf{Z} + \nabla_{\nabla_Y \mathbf{X}} \mathbf{Z} - \nabla_{\nabla_X \mathbf{Y}} \mathbf{Z} \\ &= [\nabla_X, \nabla_Y] \mathbf{Z} - \nabla_{\nabla_X \mathbf{Y} - \nabla_Y \mathbf{X}} \mathbf{Z} \\ &= [\nabla_X, \nabla_Y] \mathbf{Z} - \nabla_{\mathbf{T}(\mathbf{X}, \mathbf{Y}) + [\mathbf{X}, \mathbf{Y}]} \mathbf{Z}, \end{aligned}$$

where we used Theorem 36.2.16. We thus have

$$\nabla^2 \mathbf{Z}(\mathbf{Y}, \mathbf{X}) - \nabla^2 \mathbf{Z}(\mathbf{X}, \mathbf{Y}) = [\nabla_X, \nabla_Y] \mathbf{Z} - \nabla_{[\mathbf{X}, \mathbf{Y}]} \mathbf{Z} - \nabla_{\mathbf{T}(\mathbf{X}, \mathbf{Y})} \mathbf{Z},$$

or, using Theorem 36.2.16 again,

$$\nabla^2 \mathbf{Z}(\mathbf{Y}, \mathbf{X}) - \nabla^2 \mathbf{Z}(\mathbf{X}, \mathbf{Y}) = \mathbf{R}(\mathbf{X}, \mathbf{Y}) \mathbf{Z} + \nabla_{\mathbf{T}(\mathbf{Y}, \mathbf{X})} \mathbf{Z}. \quad (36.42)$$

Substituting ∂_i and ∂_j for \mathbf{Y} and \mathbf{X} in the equation above, we can get

$$\xi^i_{;lk} - \xi^i_{;kl} = R^i_{jkl} \xi^j + T^j_{lk} \xi^i_{;j}. \quad (36.43)$$

We leave this as an exercise for the reader.

36.3 Geodesics

Let γ be a curve in M . Denote $\gamma(t)$ by x_t , so that $\gamma(0) = x_0 \in M$. Let γ_s^t be the parallel displacement along the curve γ in M from $T_{x_t}(M)$ to $T_{x_s}(M)$. In particular, consider γ_0^t , the parallel displacement from $T_{x_t}(M)$ to $T_{x_0}(M)$ along γ . It is natural to associate the zero vector in $T_{x_t}(M)$ with x_t .³ As t varies, the zero vector also varies, and by the parallel displacement γ_0^t , one can monitor how the image of x_t “develops” in $T_{x_0}(M)$.

Definition 36.3.1 The **development** of the curve γ in M into $T_{x_0}(M)$ is the development of a curve $C_t = \gamma_0^t(x_t)$ in $T_{x_0}(M)$.

The following theorem, whose proof can be found in [Koba 63, pp 131–132], relates the tangent to the development of a curve and the parallel displacement of its tangent.

Theorem 36.3.2 Let γ be a curve in M and $\mathbf{Y}_t = \gamma_0^t(\dot{x}_t)$. Let $C_t = \gamma_0^t(x_t)$ be the development of γ in M into $T_{x_0}(M)$. Then

$$\frac{dC}{dt} = \mathbf{Y}_t.$$

This theorem states that the tangent to the development of a curve is the same as the parallel displacement of the tangent to the curve. In other words, γ_0^t “develops” not only the curve, but its tangent at every point of the curve.

An interesting consequence of this theorem is that if \dot{x}_t is parallel along γ , then \mathbf{Y}_t is independent of t , i.e., \mathbf{Y}_t is constant, say $\mathbf{Y}_t = \mathbf{a}$. Then, $C_t = \mathbf{a}t + \mathbf{b}$. Hence, we have

Corollary 36.3.3 The development of γ in M into $T_{x_0}(M)$ is a straight line iff \dot{x}_t is parallel along γ .

Curves in manifolds with a given linear connection bend for two reasons: one is because the curve itself goes back and forth in the manifold; the other is the inherent bending of the manifold itself. The straightest possible lines in a manifold are those which bend only because of the inherent bending of the manifold. Given any curve, we can gauge its bending by parallel displacement of vector fields along that curve. If the vector field has a vanishing covariant derivative, it is said to be parallel along the curve. However, that says nothing about how “curvy” the curve itself is.

To get further insight, let’s look at the familiar flat space. In the flat space of a large sheet of paper, construction of a straight line in a given direction starting at a given point P_0 is done by laying down the end of a vector (a straight edge) at P_0 pointing in the given direction, connecting P_0 to a

³This association becomes plausible if one specializes to two dimensions and notes that the plane $T_{x_t}(M)$ touches M at x_t , the natural origin of the plane.

neighboring point P_1 along the vector, moving the vector *parallel to itself* to P_1 , connecting P_1 to a neighboring point P_2 , and continuing the process. In the language of the machinery of the covariant derivative, we might say that a straight line is constructed by transporting the tangent vector parallel to itself.

Definition 36.3.4 Let M be a manifold and γ a curve in M . Then γ is called a **geodesic** of M if the tangent vector \dot{x}_t at every point of γ is parallel displaced along the curve: $\nabla_{\dot{x}_t} \dot{x}_t = 0$.

Since the definition is in terms of the parameter t , the parametrization of the curve becomes important. Such a parameter, if it exists is called an **affine parameter**. It follows from Eq. (36.36)—with $v^k = u^k = dx^k/dt$ —that a geodesic curve satisfies the following DE:

$$\frac{d^2 x^k}{dt^2} + \Gamma^k_{ij} \frac{dx^i}{dt} \frac{dx^j}{dt} = 0. \quad (36.44)$$

This second-order DE, called the **geodesic equation**, will have a unique solution if $x^i(0)$ and $\dot{x}^i(0)$, i.e., the initial point and the initial direction, are given. Thus,

Theorem 36.3.5 *Through a given point and in a given direction passes only one geodesic curve.*

If $s(t)$ is another parametrization of the geodesic curve, then a simple calculation shows that

$$0 = \frac{d^2 x^k}{dt^2} + \Gamma^k_{ij} \frac{dx^i}{dt} \frac{dx^j}{dt} = \underbrace{\left(\frac{d^2 x^k}{ds^2} + \Gamma^k_{ij} \frac{dx^i}{ds} \frac{dx^j}{ds} \right)}_{=0} (s'(t))^2 + \frac{dx^k}{ds} s''(t).$$

This requires $s''(t)$ to be zero, or $s = \alpha t + \beta$, with $\alpha, \beta \in \mathbb{R}$.

Corollary 36.3.3 leads immediately to the following:

Proposition 36.3.6 *A curve through $x \in M$ is a geodesic iff its development into $T_x(M)$ is a straight line.*

36.3.1 Riemann Normal Coordinates

Starting with a point P of an n -dimensional manifold M on which a covariant derivative is defined, we can construct a unique geodesic in every direction, i.e., for every vector in $\mathcal{T}_P(M)$. By parallel transportation of the

tangent vectors at P , we can construct a vector field in a neighborhood of P : The value of the vector field at Q —assumed to be close enough to P —is the tangent at Q on the geodesic starting at P and passing through Q .⁴ The vector field so obtained makes it possible to define an exponential map from the tangent space to the manifold. In fact, the integral curve $\exp(t\mathbf{X})$ of any tangent vector \mathbf{X} in $\mathcal{T}_P(M)$ is simply the geodesic associated with the vector.

The uniqueness of the geodesics establishes a bijection (in fact, a diffeomorphism) between a neighborhood of the origin of $\mathcal{T}_P(M)$ and a neighborhood of P in M . This diffeomorphism can be used to assign coordinates to all points in the vicinity of P . Recall that a coordinate is a smooth bijection from M to \mathbb{R}^n . Now choose a basis for $\mathcal{T}_P(M)$ and associate the components of $t\mathbf{X}$ in this basis to the points on the geodesic $\exp(t\mathbf{X})$. Specifically, if $\{a^i\}_{i=1}^n$ are the components of \mathbf{X} in the chosen basis, then

$$x^i(t) = a^i t, \quad i = 1, 2, \dots, n,$$

Riemann normal coordinates

are the so-called **Riemann normal coordinates** (RNCs) of points on the geodesic of \mathbf{X} . The geodesic equations in these coordinates become

$$\Gamma^k_{ij} a^i a^j = 0 \quad \Rightarrow \quad \Gamma^k_{ji} + \Gamma^k_{ij} = 0.$$

In particular, if the torsion vanishes, then Γ^k_{ji} is symmetric in i and j . Hence, we have the following:

Proposition 36.3.7 *The connection coefficients at a point $P \in M$ vanish in the Riemann normal coordinates at P if the torsion vanishes.*

Using Eq. (36.33), we immediately obtain the following:

Corollary 36.3.8 *Let \mathbf{T} be a tensor field on M with components $T^{i_1 \dots i_r}_{j_1 \dots j_s}$ with respect to a Riemann normal coordinate system $\{x^i\}$ at P . Then*

$$T^{i_1 \dots i_r}_{j_1 \dots j_s; k} = \frac{\partial}{\partial x^k} T^{i_1 \dots i_r}_{j_1 \dots j_s}$$

if the torsion vanishes.

Riemann normal coordinates are very useful in establishing tensor equations. This is because two tensors are identical if and only if their components are the same in any coordinate frame. Therefore, to show that two tensors fields are equal, we pick an arbitrary point in M , erect a set of RNCs, and show that the components of the tensors are equal. Since the connection coefficients vanish in an RNC system, and covariant derivatives are the same as ordinary derivatives, tensor manipulations can be simplified considerably.

⁴We are assuming that through any two neighboring points one can always draw a geodesic. For a proof see [Koba 63, pp. 172–175].

For example, the components of the curvature tensor in RNCs are

$$R^i{}_{jkl} = \frac{\partial \Gamma^i{}_{lj}}{\partial x^k} - \frac{\partial \Gamma^i{}_{kj}}{\partial x^l}. \quad (36.45)$$

This is *not* a tensor relation—the RHS is not a tensor in a general coordinate system. However, if we establish a relation involving the components of the curvature tensor alone, then that relation will hold in all coordinates, i.e., it is a tensor relation. For instance, from the equation above one immediately obtains

$$R^i{}_{jkl} + R^i{}_{ljk} + R^i{}_{klj} = 0.$$

Since this involves only a tensor, it must hold in all coordinate frames. This is the coordinate expression of Bianchi's first identity of Eq. (36.14).⁵

Example 36.3.9 Differentiate the second equation in (36.23) with respect to x^m and evaluate the result in RNC to get

$$R^i{}_{jkl;m} = R^i{}_{jkl,m} = \Gamma^i{}_{lj,km} - \Gamma^i{}_{kj,lm}.$$

From this relation and $\Gamma^i{}_{jl,km} = \Gamma^i{}_{jl,mk}$, we obtain the coordinate expression of Bianchi's second identity of Theorem 36.2.17:

$$R^i{}_{jkl;m} + R^i{}_{jmk;l} + R^i{}_{jlm;k} = 0 \quad \text{and} \quad R^i{}_{j[kl;m]} = 0. \quad (36.46)$$

In Einstein's general relativity, this identity is the analogue of Maxwell's pair of homogeneous equations: $F_{\alpha\beta,\gamma} + F_{\gamma\alpha,\beta} + F_{\beta\gamma,\alpha} = 0$.

Using Proposition 36.3.7, we establish the following tensor identity, which although derived in Riemann normal coordinates, is true in general.

Corollary 36.3.10 *Let ω be a differential form on M . If the torsion vanishes, then*

$$d\omega = \mathbb{A}(\nabla\omega),$$

where \mathbb{A} is the antisymmetrizer introduced in Eq. (26.14).

36.4 Problems

36.1 Use the fact that $R_{g*\mathbf{X}}$ is a vector at $pg \in L(M)$ to show that the canonical 1-form of $L(M)$ is a tensorial 1-form of type $(GL(n, \mathbb{R}), \mathbb{R}^n)$.

36.2 Derive the two structure equations of (36.5). Hint: For the second equation, use (34.13) with structure constants coming from Example 29.2.7.

⁵See also Problem 36.6 for both of Bianchi's identities.

36.3 Let \mathbf{Y} be a constant vector in (d) of Proposition 36.2.11 to show that $\nabla_X f = \mathbf{X}f$.

36.4 Derive Eq. (36.6).

36.5 In this problem, you are going to prove Bianchi's second identity in terms of curvature tensor.

(a) Show that

$$D^\omega \Omega(\mathbf{X}^*, \mathbf{Y}^*, \mathbf{Z}^*) = \text{Cyc}(\mathbf{X}^*(\Omega(\mathbf{Y}^*, \mathbf{Z}^*)) - \Omega([\mathbf{X}^*, \mathbf{Y}^*], \mathbf{Z}^*)).$$

(b) Using arguments similar to the text, show that

$$p(\mathbf{X}^*(\Omega(\mathbf{Y}^*, \mathbf{Z}^*))) = \nabla_X \mathbf{R}(\mathbf{Y}, \mathbf{Z})$$

(c) Convince yourself that

$$p\Omega([\mathbf{X}^*, \mathbf{Y}^*], \mathbf{Z}^*) = \mathbf{R}(\pi_*[\mathbf{X}^*, \mathbf{Y}^*], \mathbf{Z}).$$

(d) Use $\pi_* = p \circ \theta$ and the fact that

$$\theta[\mathbf{X}^*, \mathbf{Y}^*] = d\theta(\mathbf{X}^*, \mathbf{Y}^*) = \Theta(\mathbf{X}^*, \mathbf{Y}^*)$$

to show that $\pi_*[\mathbf{X}^*, \mathbf{Y}^*] = \mathbf{T}(\mathbf{X}, \mathbf{Y})$.

(e) Put everything together and show that $\text{Cyc}[\nabla_X \mathbf{R}(\mathbf{Y}, \mathbf{Z})] = 0$ when torsion tensor vanishes.

36.6 Derive the coordinate expression for Bianchi's first and second identities of Theorem 36.2.18.

36.7 Use $Y_k^i X_j^k = \delta_j^i$ to show that

$$\partial_k^m Y_j^i \equiv \frac{\partial}{\partial X_m^k} Y_j^i = -Y_k^j Y_j^m$$

36.8 From Eq. (36.18) show that $b_{jk}^i = \Gamma_{km}^l Y_l^i X_j^m$. Now use this result to rewrite Eq. (36.16) as (36.19).

36.9 Derive Eq. (36.21).

36.10 Prove the formulas in Eq. (36.23).

36.11 Substituting (36.20) in (36.24) and noting the antisymmetry of the wedge product, derive Eq. (36.25).

36.12 Let $\mathbf{Z} = \xi^k \partial_k$. Show that

$$(\nabla \mathbf{Z})_j^i \equiv \xi_{;j}^i = \frac{\partial \xi^i}{\partial x^j} + \Gamma_{jk}^i \xi^k$$

and

$$\xi_{;lk}^i - \xi_{;kl}^i = R_{jkl}^i \xi^j + T_{lk}^j \xi_{;j}^i$$

The differential geometry of the last chapter covered most of what is needed for many applications. However, it lacked the essential ingredient of a metric. Almost all spaces (manifolds) encountered in physics have a natural metric which is either known from the beginning, or is derived from some of its physical properties (general theory of relativity). In this chapter, we look at spaces whose connections are tied to their metrics.

37.1 The Metric Connection

Let $P(M, G)$ be a principal fiber bundle. Let ρ be a representation of G into $GL(m, \mathbb{R})$, and $E(M, \mathbb{R}^m, G, P)$ the vector bundle associated with P with standard fiber \mathbb{R}^m on which G acts through ρ . A **fiber metric** is a map $\mathbf{g} : M \rightarrow T_2^0(E)$ such that $\mathbf{g}_x \equiv \mathbf{g}(x)$ is an inner product in the fiber $\pi_E^{-1}(x)$ which is differentiable in x . For all physical applications, the structure of the base manifold M is such that a fiber metric always exists for *any* vector bundle E associated with $P(M, G)$.

fiber metric

Given a connection Γ in P , we can define a parallelism on the associated bundle E based on which we construct an isomorphism of the fibers. If this isomorphism preserves the inner product, i.e., if the isomorphism is an isometry, we say that the connection is a **metric connection**. This property can be restated by saying that \mathbf{g} is parallel. Hence, by Proposition 36.2.15, we have

metric connection

Theorem 37.1.1 *A connection Γ with covariant differential ∇ is metric with respect to the metric \mathbf{g} iff $\nabla \mathbf{g} = 0$, i.e., $g_{ij;k} = 0 \forall i, j, k$.*

A statement equivalent to this theorem is that

Box 37.1.2 *The operation of raising and lowering of indices commutes with the operation of covariant differentiation.*

Consider two vectors \mathbf{v} and \mathbf{w} . If the covariant derivative of \mathbf{g} vanishes, then

$$\begin{aligned}\nabla_{\mathbf{u}}[\mathbf{g}(\mathbf{v}, \mathbf{w})] &\equiv \nabla_{\mathbf{u}}\langle \mathbf{g}, \mathbf{v} \otimes \mathbf{w} \rangle \\ &= \langle \nabla_{\mathbf{u}}\mathbf{g}, \mathbf{v} \otimes \mathbf{w} \rangle + \langle \mathbf{g}, (\nabla_{\mathbf{u}}\mathbf{v}) \otimes \mathbf{w} \rangle + \langle \mathbf{g}, \mathbf{v} \otimes (\nabla_{\mathbf{u}}\mathbf{w}) \rangle \\ &= \mathbf{g}(\nabla_{\mathbf{u}}\mathbf{v}, \mathbf{w}) + \mathbf{g}(\mathbf{v}, \nabla_{\mathbf{u}}\mathbf{w}).\end{aligned}\tag{37.1}$$

In particular, if \mathbf{v} and \mathbf{w} are parallel displaced along \mathbf{u} , their inner product will not change.

When there is a fiber metric in E , the group representation by which G acts on the standard fiber of E , can be made to take values in the group $O(m - \nu, \nu)$ (see Sect. 29.2.1) so that $\rho : G \rightarrow O(m - \nu, \nu)$ becomes the new representation. So, the group associated with the vector bundle E is $O(m - \nu, \nu)$ when there is a metric connection. In particular, when we deal with a linear connection, $E = T(M)$ and the structure group becomes $O(n - \nu, \nu)$.

Riemannian and pseudo/semi-Riemannian manifolds defined

Definition 37.1.3 A **Riemannian manifold** is a differentiable manifold M with a metric $\mathbf{g} \in T_2^0(M)$, such that at each point $x \in M$, $\mathbf{g}|_x$ is a positive definite inner product. A manifold with an indefinite inner product at each point is called a **pseudo/semi-Riemannian manifold**.

Historical Notes

No great mind of the past has exerted a deeper influence on the mathematics of the twentieth century than **Georg Friedrich Bernhard Riemann** (1826–1866), the son of a poor country minister in northern Germany. He studied the works of Euler and Legendre while he was still in secondary school, and it is said that he mastered Legendre's treatise on the theory of numbers in less than a week. But he was shy and modest, with little awareness of his own extraordinary abilities, so at the age of 19 he went to the University of Göttingen with the aim of pleasing his father by studying theology and becoming a minister himself. Fortunately, this worthy purpose soon stuck in his throat, and with his father's willing permission he switched to mathematics.

The presence of the legendary Gauss automatically made Göttingen the center of the mathematical world. But Gauss was remote and unapproachable—particularly to beginning students—and after only a year Riemann left this unsatisfying environment and went to the University of Berlin. There he attracted the friendly interest of Dirichlet and Jacobi, and learned a great deal from both men. Two years later he returned to Göttingen, where he obtained his doctor's degree in 1851. During the next 8 years, despite debilitating poverty, he created his greatest works. In 1854 he was appointed Privatdozent (unpaid lecturer), which at that time was the necessary first step on the academic ladder. Gauss died in 1855, and Dirichlet was called to Göttingen as his successor. Dirichlet helped Riemann in every way he could, first with a small salary (about one-tenth of that paid to a full professor) and then with a promotion to an assistant professorship. In 1859 he also died, and Riemann was appointed as a full professor to replace him. Riemann's years of poverty were over, but his health was broken. At the age of 39 he died of tuberculosis in Italy, on the last of several trips he undertook in order to escape the cold, wet climate of northern Germany. Riemann had a short life and published comparatively little, but his works permanently altered the course of mathematics in analysis, geometry, and number theory.

It is said that the three greatest mathematicians of modern times are Euler, Gauss, and Riemann. It is a curiosity of nature that these three names are among the most frequently mentioned names in the physics literature as well. Aside from the indirect use of his name in the application of complex analysis in physics, **Riemannian geometry** has become the most essential building block of all theories of fundamental interactions, starting with



Georg Friedrich
Bernhard Riemann
1826–1866

gravity, which Einstein formulated in this language in 1916. As part of the requirement to become a Privatdozent, Riemann had to write a probationary essay and to present a trial lecture to the faculty. It was the custom for the candidate to offer three titles, and the head of his department usually accepted the first. However, Riemann rashly listed as his third topic the foundations of geometry. Gauss, who had been turning this subject over in his mind for 60 years, was naturally curious to see how this particular candidate's "gloriously fertile originality" would cope with such a challenge, and to Riemann's dismay he designated this as the subject of the lecture. Riemann quickly tore himself away from his other interests at the time—"my investigations of the connection between electricity, magnetism, light, and gravitation"—and wrote his lecture in the next two months. The result was one of the great classical masterpieces of mathematics, and probably the most important scientific lecture ever given. It is recorded that even Gauss was surprised and enthusiastic.

Since a (semi)Riemannian manifold has a metric, at each point x there is a fiber metric, namely $\mathbf{g}(x)$. As before, a connection Γ is a metric connection if \mathbf{g} is parallel with respect to Γ . There may be many connections on a (semi)Riemannian manifold. In fact, any set of functions that transform according to Eq. (36.21) define a unique connection by Theorem 36.2.19. Many of these connections may be metric. However, one connection stands out. (See [Koba 63, pp 158–160] for a proof of the following theorem.)

Levi-Civita connection

Theorem 37.1.4 *Every (semi-)Riemannian manifold admits a unique metric connection, called **Levi-Civita connection**, whose torsion is zero.*

Because of the uniqueness of the Levi-Civita connection, we can identify it with the manifold itself. And since an important property of the connection is whether it is flat or not, we have

Definition 37.1.5 A (semi-)Riemannian manifold is called **flat** if its Levi-Civita connection is flat.

Applying Theorem 34.3.11 and Eq. (36.8), we also have

Proposition 37.1.6 *A (semi-)Riemannian manifold is flat iff its curvature \mathbf{R} vanishes identically.*

Given the metric \mathbf{g} of the (semi)Riemannian manifold, define a covariant derivative as follows

$$2\mathbf{g}(\nabla_X \mathbf{Y}, \mathbf{Z}) = \mathbf{X}(\mathbf{g}(\mathbf{Y}, \mathbf{Z})) + \mathbf{Y}(\mathbf{g}(\mathbf{X}, \mathbf{Z})) - \mathbf{Z}(\mathbf{g}(\mathbf{X}, \mathbf{Y})) \\ + \mathbf{g}([\mathbf{X}, \mathbf{Y}], \mathbf{Z}) + \mathbf{g}([\mathbf{Z}, \mathbf{X}], \mathbf{Y}) + \mathbf{g}([\mathbf{Z}, \mathbf{Y}], \mathbf{X}). \quad (37.2)$$

It is straightforward to show that this covariant derivative satisfies the four conditions of Proposition 36.2.11. Therefore, by Theorem 36.2.12, it is the covariant derivative with respect to some linear connection. That linear connection turns out to be the Levi-Civita connection. Problem 37.2 shows that if $\nabla \mathbf{g} = 0$, then (37.2) holds.



Tullio Levi-Civita
1873–1941

Historical Notes

Tullio Levi-Civita (1873–1941), the son of Giacomo Levi-Civita, a lawyer who from 1908 was a senator, was an outstanding student at the liceo in Padua. In 1890 he enrolled in the Faculty of Mathematics of the University of Padua. Giuseppe Veronese and Gregorio Ricci-Curbastro were among his teachers. He received his diploma in 1894 and in 1895 became resident professor at the teachers' college annexed to the Faculty of Science at Pavia. From 1897 to 1918 Levi-Civita taught rational mechanics at the University of Padua. His years in Padua (where in 1914 he married a pupil, Libera Trevisani) were scientifically the most fruitful of his career. In 1918 he became professor of higher analysis at Rome and, in 1920, of rational mechanics. In 1938, struck by the fascist racial laws against Jews, he was forced to give up teaching.

The breadth of his scientific interests, his scruples regarding the fulfillment of his academic responsibilities, and his affection for young people made Levi-Civita the leader of a flourishing school of mathematicians.

Levi-Civita's approximately 200 memoirs in pure and applied mathematics deal with analytical mechanics, celestial mechanics, hydrodynamics, elasticity, electromagnetism, and atomic physics. His most important contribution to science was rooted in the memoir "Sulle trasformazioni delle equazioni dinamiche" (1896), which was characterized by the use of the methods of absolute differential calculus that Ricci had applied only to differential geometry. In the "Méthodes de calcul différentiel absolu et leurs applications", written with Ricci and published in 1900 in *Mathematische Annalen*, there is a complete exposition of the new calculus, which consists of a particular algorithm designed to express geometric and physical laws in Euclidean and non-Euclidean spaces, particularly in Riemannian curved spaces. The memoir concerns a very general but laborious type of calculus that made it possible to deal with many difficult problems, including, according to Einstein, the formulation of the general theory of relativity.

Although Levi-Civita had expressed certain reservations concerning relativity in the first years after its formulation (1905), he gradually came to accept the new views. His own original research culminated in 1917 in the introduction of the concept of *parallel transport* in curved spaces. With this new concept, absolute differential calculus, having absorbed other techniques, became tensor calculus, now the essential instrument of the unitary relativistic theories of gravitation and electromagnetism.

In his memoirs of 1903–1916 Levi-Civita contributed to celestial mechanics in the study of the three-body problem: the determination of the motion of three bodies, considered as reduced to their centers of mass and subject to mutual Newtonian attraction. In 1914–1916 he succeeded in eliminating the singularities present at the points of possible collisions, past or future. His research in relativity led Levi-Civita to mathematical problems suggested by atomic physics, which in the 1920s was developing outside the traditional framework: the general theory of adiabatic invariants, the motion of a body of variable mass, the extension of the Maxwellian distribution to a system of corpuscles, and the Schrödinger equation.

The components of the curvature, the Riemann-Christoffel symbols, can be calculated by substituting the coordinate vector fields $\{\partial_i\}$ in Eq. (37.2). It is then easy to show that

$$\Gamma_{ij}^k = \frac{1}{2} g^{mk} \left(\frac{\partial g_{jm}}{\partial x^i} + \frac{\partial g_{im}}{\partial x^j} - \frac{\partial g_{ij}}{\partial x^m} \right). \quad (37.3)$$

This equation is sometimes written as

$$\Gamma_{kij} = \frac{1}{2} \left(\frac{\partial g_{jk}}{\partial x^i} + \frac{\partial g_{ik}}{\partial x^j} - \frac{\partial g_{ij}}{\partial x^k} \right), \quad (37.4)$$

where $\Gamma_{kij} \equiv g_{km} \Gamma_{ij}^m$.

Now we consider the connection between an infinitesimal displacement and a metric. Let P be a point of M . Let γ be a curve through P such that $\gamma(c) = P$. For an infinitesimal number δu , let $P' = \gamma(c + \delta u)$ be a point

on γ close to P . Since the x^i are well-behaved functions, $x^i(P') - x^i(P)$ are infinitesimal real numbers. Let $\xi^i = x^i(P') - x^i(P)$, and construct the vector $\mathbf{v} = \xi^i \partial_i$, where $\{\partial_i\}$ consists of tangent vectors at P . We call \mathbf{v} the **infinitesimal displacement** at P . The length (squared) of this vector, $\mathbf{g}(\mathbf{v}, \mathbf{v})$, is shown to be $g_{ij} \xi^i \xi^j$. This is called the **arc length** from P to P' , and is naturally written as $ds^2 = g_{ij} \xi^i \xi^j$. It is customary to write dx^i (not a 1-form!) in place of ξ^i :

$$ds^2 = g_{ij} dx^i dx^j, \quad (37.5)$$

where the dx^i are infinitesimal real numbers.

In applications, it is common to start with the metric tensor \mathbf{g} given in terms of coordinate differential forms:

$$\mathbf{g} = g_{ij} dx^i \otimes dx^j, \quad \text{where} \quad g_{ij} = g_{ji} = \mathbf{g}(\partial_i, \partial_j). \quad (37.6)$$

The equivalence of the arc length (37.5) and the metric (37.6) is the reason why it is the arc length that is given in most practical problems. Once the arc length is known, the metric g_{ij} can be read off, and all the relevant geometric quantities can be calculated from it.

Example 37.1.7 Let us determine the geodesics of the space whose arc length is given by $ds^2 = (dx^2 + dy^2)/y^2$ (see also Example 37.1.10). With $x = x^1$ and $y = x^2$, we recognize the metric tensor as

$$\begin{aligned} g_{11} = g_{22} &= \frac{1}{y^2}, & g_{12} = g_{21} &= 0, \\ g^{11} = g^{22} &= y^2, & g^{12} = g^{21} &= 0. \end{aligned}$$

Using Eq. (37.4), we can readily calculate the nonzero connection coefficients:

$$\Gamma_{112} = \Gamma_{121} = -\Gamma_{211} = \Gamma_{222} = -\frac{1}{y^3}.$$

The geodesic equation for the first coordinate is

$$\frac{d^2 x}{dt^2} + \Gamma^1_{ij} \frac{dx^i}{dt} \frac{dx^j}{dt} = 0,$$

or

$$\frac{d^2 x}{dt^2} + \Gamma^1_{11} \left(\frac{dx}{dt} \right)^2 + 2\Gamma^1_{12} \frac{dx}{dt} \frac{dy}{dt} + \Gamma^1_{22} \left(\frac{dy}{dt} \right)^2 = 0.$$

To find the connection coefficients with raised indices, we multiply those with all indices lowered by the inverse of the metric tensor. For instance,

$$\Gamma^1_{12} = g^{1i} \Gamma_{i12} = g^{11} \Gamma_{112} + \underbrace{g^{12}}_{=0} \Gamma_{212} = y^2 \left(-\frac{1}{y^3} \right) = -\frac{1}{y}.$$

Similarly, $\Gamma^1_{11} = 0 = \Gamma^1_{22}$, and the geodesic equation for the first coordinate becomes

$$\frac{d^2x}{dt^2} - 2\frac{1}{y}\frac{dx}{dt}\frac{dy}{dt} = 0. \quad (37.7)$$

For the second coordinate, we need Γ^2_{11} , Γ^2_{12} , and Γ^2_{22} . These can be readily evaluated as above, with the result

$$\Gamma^2_{11} = -\Gamma^2_{22} = \frac{1}{y}, \quad \Gamma^2_{12} = 0,$$

yielding the geodesic equation for the second coordinate

$$\frac{d^2y}{dt^2} + \frac{1}{y}\left(\frac{dx}{dt}\right)^2 - \frac{1}{y}\left(\frac{dy}{dt}\right)^2 = 0. \quad (37.8)$$

With $\dot{x} \equiv dx/dt$, Eq. (37.7) can be written as

$$\frac{d\dot{x}}{dt} - 2\dot{x}\frac{dy/dt}{y} = 0 \Rightarrow \frac{d\dot{x}/dt}{\dot{x}} = 2\frac{dy/dt}{y} \Rightarrow \dot{x} = Cy^2.$$

Using the chain rule and the notation $y' \equiv dy/dx$, we obtain

$$\begin{aligned} \frac{dy}{dt} &= y'\dot{x} = Cy^2y', \\ \frac{d^2y}{dt^2} &= C\left(2y\frac{dy}{dt}y' + y^2\frac{dy'}{dx}\dot{x}\right) = C^2(2y^3y'^2 + y^4y''). \end{aligned}$$

Substituting in Eq. (37.8) yields

$$y^3y'^2 + y^4y'' + y^3 = 0 \Rightarrow (y')^2 + yy'' + 1 = 0 \Rightarrow \frac{d}{dx}(yy') + 1 = 0.$$

It follows that $yy' = -x + A$ and $x^2 + y^2 = 2Ax + B$. Thus, the geodesics are circles with arbitrary radii whose centers lie on the x -axis.

37.1.1 Orthogonal Bases

The presence of a metric allows for orthonormal bases, which are sometimes more convenient than the coordinate bases. If the structure group reduces to $O(n)$, then $\mathfrak{g}(n; \mathbb{R})$ reduces to $\mathfrak{o}(n)$, which is the set of antisymmetric matrices.¹ Therefore, the \mathbf{E}_i^j s in Eq. (36.4) will be antisymmetric in i and j , making ω_j^i and Ω_j^i also antisymmetric. This simplifies the calculation of the curvature form as given in Box 36.2.9. For this, we need the orthonormal bases $\{\mathbf{e}_i\}$ and $\{\boldsymbol{\epsilon}^i\}$, which can be constructed in terms of $\{\partial_i\}$ and $\{dx^i\}$, respectively. The following examples illustrate the procedure.

¹Although we are restricting the discussion to $O(n)$, it also applies to the more general group $O(n - \nu, \nu)$.

Example 37.1.8 Let us look at a few examples of arc lengths, the corresponding metrics, and the orthogonal bases derived from them.

- (a) For $ds^2 = dx^2 + dy^2 + dz^2$, \mathbf{g} is the Euclidean metric of \mathbb{R}^3 , with $g_{ij} = \delta_{ij}$.
- (b) For $ds^2 = -dx^2 - dy^2 - dz^2 + dt^2$, \mathbf{g} is the Minkowski (or Lorentz) metric of \mathbb{R}^4 , with $g_{ij} = \eta_{ij}$, where $\eta_{xx} = \eta_{yy} = \eta_{zz} = -\eta_{tt} = -1$ and $\eta_{ij} = 0$ for $i \neq j$.
- (c) For $ds^2 = dr^2 + r^2(d\theta^2 + \sin^2\theta d\varphi^2)$, the metric is the Euclidean metric given in spherical coordinates in \mathbb{R}^3 with $g_{rr} = 1$, $g_{\theta\theta} = r^2$, $g_{\varphi\varphi} = r^2 \sin^2\theta$, and all other components zero.
- (d) For $ds^2 = a^2 d\theta^2 + a^2 \sin^2\theta d\varphi^2$, the metric is that of a two-dimensional spherical surface, with $g_{\theta\theta} = a^2$, $g_{\varphi\varphi} = a^2 \sin^2\theta$, and all other components zero.
- (e) For

$$ds^2 = dt^2 - a^2(t)[d\chi^2 + \sin^2\chi(d\theta^2 + \sin^2\theta d\varphi^2)],$$

the metric is the **Friedmann metric** used in cosmology. Here

Friedmann metric

$$\begin{aligned} g_{tt} &= 1, & g_{\chi\chi} &= -[a(t)]^2, \\ g_{\theta\theta} &= -[a(t)]^2 \sin^2\chi, & g_{\varphi\varphi} &= -[a(t)]^2 \sin^2\chi \sin^2\theta. \end{aligned}$$

- (f) For

$$ds^2 = \left(1 - \frac{2M}{r}\right) dt^2 - \left(1 - \frac{2M}{r}\right)^{-1} dr^2 - r^2(d\theta^2 + \sin^2\theta d\varphi^2),$$

the metric is the **Schwarzschild metric** with

Schwarzschild metric

$$\begin{aligned} g_{tt} &= 1 - 2M/r, & g_{rr} &= -(1 - 2M/r)^{-1}, \\ g_{\theta\theta} &= -r^2, & g_{\varphi\varphi} &= -r^2 \sin^2\theta. \end{aligned}$$

For each of the arc lengths above, we have an orthonormal basis of one-forms:

- (a) $\mathbf{g} = \epsilon^1 \otimes \epsilon^1 + \epsilon^2 \otimes \epsilon^2 + \epsilon^3 \otimes \epsilon^3$, with

$$\epsilon^1 = dx, \quad \epsilon^2 = dy, \quad \epsilon^3 = dz;$$

- (b) $\mathbf{g} = -\epsilon^1 \otimes \epsilon^1 - \epsilon^2 \otimes \epsilon^2 - \epsilon^3 \otimes \epsilon^3 + \epsilon^0 \otimes \epsilon^0$, with

$$\epsilon^1 = dx, \quad \epsilon^2 = dy, \quad \epsilon^3 = dz, \quad \epsilon^0 = dt;$$

- (c) $\mathbf{g} = \epsilon^r \otimes \epsilon^r + \epsilon^\theta \otimes \epsilon^\theta + \epsilon^\varphi \otimes \epsilon^\varphi$, with

$$\epsilon^r = dr, \quad \epsilon^\theta = r d\theta, \quad \epsilon^\varphi = r \sin\theta d\varphi;$$

- (d) $\mathbf{g} = \epsilon^\theta \otimes \epsilon^\theta + \epsilon^\varphi \otimes \epsilon^\varphi$, with $\epsilon^\theta = a d\theta$, $\epsilon^\varphi = a \sin\theta d\varphi$;

- (e) $\mathbf{g} = \epsilon^t \otimes \epsilon^t - \epsilon^\chi \otimes \epsilon^\chi - \epsilon^\theta \otimes \epsilon^\theta - \epsilon^\varphi \otimes \epsilon^\varphi$, with

$$\begin{aligned} \epsilon^t &= dt, & \epsilon^\chi &= a(t) d\chi, \\ \epsilon^\theta &= a(t) \sin\chi d\theta, & \epsilon^\varphi &= a(t) \sin\chi \sin\theta d\varphi; \end{aligned}$$

(f) $\mathbf{g} = \boldsymbol{\epsilon}^t \otimes \boldsymbol{\epsilon}^t - \boldsymbol{\epsilon}^r \otimes \boldsymbol{\epsilon}^r - \boldsymbol{\epsilon}^\theta \otimes \boldsymbol{\epsilon}^\theta - \boldsymbol{\epsilon}^\varphi \otimes \boldsymbol{\epsilon}^\varphi$, with

$$\begin{aligned}\boldsymbol{\epsilon}^t &= (1 - 2M/r)^{1/2} dt, & \boldsymbol{\epsilon}^r &= (1 - 2M/r)^{-1/2} dr, \\ \boldsymbol{\epsilon}^\theta &= r d\theta, & \boldsymbol{\epsilon}^\varphi &= r \sin \theta d\varphi.\end{aligned}$$

Example 37.1.9 In this example, we examine the curvilinear coordinates used in vector analysis. Recall that in terms of these coordinates the displacement is given by $ds^2 = h_1^2(dq_1)^2 + h_2^2(dq_2)^2 + h_3^2(dq_3)^2$. Therefore, the orthonormal one-forms are $\boldsymbol{\epsilon}^1 = h_1 dq_1$, $\boldsymbol{\epsilon}^2 = h_2 dq_2$, $\boldsymbol{\epsilon}^3 = h_3 dq_3$. We also note (see Problem 28.23) that

$$\begin{aligned}d * df &= \left(\frac{\partial^2 f}{\partial x^2} + \frac{\partial^2 f}{\partial y^2} + \frac{\partial^2 f}{\partial z^2} \right) dx \wedge dy \wedge dz \\ &= \nabla^2 f dx \wedge dy \wedge dz.\end{aligned}\tag{37.9}$$

We use this equation to find the Laplacian in terms of q_1 , q_2 , and q_3 :

$$\begin{aligned}df &= \frac{\partial f}{\partial q_1} dq_1 + \frac{\partial f}{\partial q_2} dq_2 + \frac{\partial f}{\partial q_3} dq_3 \\ &= \left(\frac{1}{h_1} \frac{\partial f}{\partial q_1} \right) \boldsymbol{\epsilon}^1 + \left(\frac{1}{h_2} \frac{\partial f}{\partial q_2} \right) \boldsymbol{\epsilon}^2 + \left(\frac{1}{h_3} \frac{\partial f}{\partial q_3} \right) \boldsymbol{\epsilon}^3,\end{aligned}$$

where we substituted orthonormal 1-forms so we could apply the Hodge star operator. It follows now that

$$\begin{aligned}*df &= \left(\frac{1}{h_1} \frac{\partial f}{\partial q_1} \right) * \boldsymbol{\epsilon}^1 + \left(\frac{1}{h_2} \frac{\partial f}{\partial q_2} \right) * \boldsymbol{\epsilon}^2 + \left(\frac{1}{h_3} \frac{\partial f}{\partial q_3} \right) * \boldsymbol{\epsilon}^3 \\ &= \left(\frac{1}{h_1} \frac{\partial f}{\partial q_1} \right) \boldsymbol{\epsilon}^2 \wedge \boldsymbol{\epsilon}^3 + \left(\frac{1}{h_2} \frac{\partial f}{\partial q_2} \right) \boldsymbol{\epsilon}^3 \wedge \boldsymbol{\epsilon}^1 + \left(\frac{1}{h_3} \frac{\partial f}{\partial q_3} \right) \boldsymbol{\epsilon}^1 \wedge \boldsymbol{\epsilon}^2 \\ &= \left(\frac{h_2 h_3}{h_1} \frac{\partial f}{\partial q_1} \right) dq_2 \wedge dq_3 + \left(\frac{h_1 h_3}{h_2} \frac{\partial f}{\partial q_2} \right) dq_3 \wedge dq_1 \\ &\quad + \left(\frac{h_1 h_2}{h_3} \frac{\partial f}{\partial q_3} \right) dq_1 \wedge dq_2.\end{aligned}$$

Differentiating once more, we get

$$\begin{aligned}d * df &= \frac{\partial}{\partial q_1} \left(\frac{h_2 h_3}{h_1} \frac{\partial f}{\partial q_1} \right) dq_1 \wedge dq_2 \wedge dq_3 \\ &\quad + \frac{\partial}{\partial q_2} \left(\frac{h_1 h_3}{h_2} \frac{\partial f}{\partial q_2} \right) dq_2 \wedge dq_3 \wedge dq_1 \\ &\quad + \frac{\partial}{\partial q_3} \left(\frac{h_1 h_2}{h_3} \frac{\partial f}{\partial q_3} \right) dq_3 \wedge dq_1 \wedge dq_2 \\ &= \left\{ \frac{1}{h_1 h_2 h_3} \left[\frac{\partial}{\partial q_1} \left(\frac{h_2 h_3}{h_1} \frac{\partial f}{\partial q_1} \right) + \frac{\partial}{\partial q_2} \left(\frac{h_1 h_3}{h_2} \frac{\partial f}{\partial q_2} \right) \right. \right. \\ &\quad \left. \left. + \frac{\partial}{\partial q_3} \left(\frac{h_1 h_2}{h_3} \frac{\partial f}{\partial q_3} \right) \right] \right\} \boldsymbol{\epsilon}^1 \wedge \boldsymbol{\epsilon}^2 \wedge \boldsymbol{\epsilon}^3.\end{aligned}\tag{37.10}$$

Since $\{\epsilon^1, \epsilon^2, \epsilon^3\}$ are orthonormal one-forms (as are $\{dx, dy, dz\}$), the volume elements $\epsilon^1 \wedge \epsilon^2 \wedge \epsilon^3$ and $dx \wedge dy \wedge dz$ are equal. Thus, we substitute the latter for the former in (37.10), compare with (37.9), and conclude that

$$\nabla^2 f = \frac{1}{h_1 h_2 h_3} \left[\frac{\partial}{\partial q_1} \left(\frac{h_2 h_3}{h_1} \frac{\partial f}{\partial q_1} \right) + \frac{\partial}{\partial q_2} \left(\frac{h_1 h_3}{h_2} \frac{\partial f}{\partial q_2} \right) + \frac{\partial}{\partial q_3} \left(\frac{h_1 h_2}{h_3} \frac{\partial f}{\partial q_3} \right) \right],$$

which is the result obtained in curvilinear vector analysis.

In an orthonormal frame, Eq. (36.20) becomes

$$\omega_j^i = \Gamma_{lj}^i \epsilon^l, \quad (37.11)$$

where as usual, we have omitted the subscript U . Furthermore, using Eq. (36.6) with $\mathbf{T} = \epsilon^i$, one can easily show that

$$\nabla \epsilon^i = -\Gamma_{jk}^i \epsilon^k \otimes \epsilon^j = -\Gamma_{kj}^i \epsilon^k \otimes \epsilon^j = -\omega_j^i \otimes \epsilon^j$$

for a Levi-Civita connection. Now use Corollary 36.3.10 to obtain

$$d\epsilon^i = \mathbb{A}(\nabla \epsilon^i) = \mathbb{A}(-\omega_j^i \otimes \epsilon^j) = -\omega_j^i \wedge \epsilon^j. \quad (37.12)$$

This can also be written in matrix form if we use Box 36.2.9 and define the column vector $\boldsymbol{\varepsilon}$ with elements ϵ^i . We then have

$$d\boldsymbol{\varepsilon} = -\widehat{\boldsymbol{\omega}} \wedge \boldsymbol{\varepsilon}.$$

Taking the exterior derivative of this equation gives

$$0 = d^2 \boldsymbol{\varepsilon} = -d\widehat{\boldsymbol{\omega}} \wedge \boldsymbol{\varepsilon} + \widehat{\boldsymbol{\omega}} \wedge d\boldsymbol{\varepsilon} = -d\widehat{\boldsymbol{\omega}} \wedge \boldsymbol{\varepsilon} - \widehat{\boldsymbol{\omega}} \wedge \widehat{\boldsymbol{\omega}} \wedge \boldsymbol{\varepsilon} = -\widehat{\boldsymbol{\Omega}} \wedge \boldsymbol{\varepsilon}.$$

Combining the two equations, we get

$$d\boldsymbol{\varepsilon} = -\widehat{\boldsymbol{\omega}} \wedge \boldsymbol{\varepsilon}, \quad \widehat{\boldsymbol{\Omega}} \wedge \boldsymbol{\varepsilon} = 0. \quad (37.13)$$

The antisymmetry of Ω_j^i in i and j and Eq. (36.25) give

$$R_{jkl}^i + R_{ikl}^j = 0, \quad R_{jkl}^i + R_{jlk}^i = 0. \quad (37.14)$$

Similarly, the second relation of Eq. (37.13) can be shown to be equivalent to

$$R_{jkl}^i + R_{klj}^i + R_{ljk}^i = 0 \quad \text{and} \quad R_{[ijkl]} = 0, \quad (37.15)$$

where the enclosure of indices in square brackets means complete antisymmetrization of those indices. The first relation of (37.15) can also be obtained from Bianchi's 1st identity given in Theorem 36.2.17.

It is also common to lower the upper index by the metric and define $R_{ijkl} = g_{im} R_{jkl}^m$. Then the new tensor has the additional properties

$$R_{ijkl} = R_{klij} \quad \text{and} \quad R_{[ijkl]} = 0. \quad (37.16)$$

Square brackets mean antisymmetrization.

Equation (37.12) gives us a recipe for finding the curvature from the arc length. Given the arc length, construct the orthogonal 1-forms as in Examples 37.1.8 and 37.1.9. Then take the exterior derivative of a typical one and read off ω_k^i from the right-hand side of the equation. Form the matrix $\widehat{\omega}$ and use Box 36.2.9 to calculate $\widehat{\Omega}$. The coefficients of the entries of $\widehat{\Omega}$ are the components of the Riemann curvature tensor according to Eq. (36.25).

Example 37.1.10 Let $M = \mathbb{R}^2$, and suppose that the arc length is given by $ds^2 = (dx^2 + dy^2)/y^2$ (see Example 37.1.7). We can write the metric as $\mathbf{g} = \epsilon^1 \otimes \epsilon^1 + \epsilon^2 \otimes \epsilon^2$ if we define

$$\epsilon^1 = \frac{dx}{y} \quad \text{and} \quad \epsilon^2 = \frac{dy}{y}.$$

To find the curvature tensor, we take the exterior derivative of the ϵ^i 's:

$$d\epsilon^1 = d\left(\frac{1}{y}dx\right) = -\frac{1}{y^2}dy \wedge dx = \epsilon^1 \wedge \epsilon^2, \quad d\epsilon^2 = 0. \quad (37.17)$$

From these equations, the antisymmetry of the ω 's, and Eq. (37.12), we can read off ω_j^i . They are $\omega_1^1 = \omega_2^2 = 0$ and $\omega_2^1 = -\omega_1^2 = \epsilon^1$. Thus, the matrix $\widehat{\omega}$ is

$$\begin{aligned} \widehat{\omega} &= \omega_1^2 \mathbf{E}_2^1 + \omega_2^1 \mathbf{E}_1^2 = \omega_1^2 \begin{pmatrix} 0 & 1 \\ 0 & 0 \end{pmatrix} + \omega_2^1 \begin{pmatrix} 0 & 0 \\ 1 & 0 \end{pmatrix} \\ &= \begin{pmatrix} 0 & \omega_1^2 \\ \omega_2^1 & 0 \end{pmatrix} = \begin{pmatrix} 0 & -\epsilon^1 \\ \epsilon^1 & 0 \end{pmatrix}, \end{aligned}$$

which gives

$$d\widehat{\omega} = \begin{pmatrix} 0 & -d\epsilon^1 \\ d\epsilon^1 & 0 \end{pmatrix} = \begin{pmatrix} 0 & -\epsilon^1 \wedge \epsilon^2 \\ \epsilon^1 \wedge \epsilon^2 & 0 \end{pmatrix},$$

and

$$\widehat{\omega} \wedge \widehat{\omega} = \begin{pmatrix} 0 & -\epsilon^1 \\ \epsilon^1 & 0 \end{pmatrix} \wedge \begin{pmatrix} 0 & -\epsilon^1 \\ \epsilon^1 & 0 \end{pmatrix} = 0.$$

Therefore, the curvature matrix is

$$\widehat{\Omega} = d\widehat{\omega} = \begin{pmatrix} 0 & -\epsilon^1 \wedge \epsilon^2 \\ \epsilon^1 \wedge \epsilon^2 & 0 \end{pmatrix} \equiv \begin{pmatrix} 0 & \Omega_2^1 \\ \Omega_1^2 & 0 \end{pmatrix}.$$

This shows that the only nonzero independent component of the Riemann curvature tensor is $R_{1212} = -1$.

Example 37.1.11 For a spherical surface of radius a , the element of length is

$$ds^2 = a^2 d\theta^2 + a^2 \sin^2 \theta d\varphi^2.$$

The orthonormal forms are $\epsilon^\theta = a d\theta$ and $\epsilon^\varphi = a \sin \theta d\varphi$, and we have

$$d\epsilon^\theta = 0, \quad d\epsilon^\varphi = a \cos \theta d\theta \wedge d\varphi = \frac{1}{a} \cot \theta \epsilon^\theta \wedge \epsilon^\varphi.$$

The matrix $\widehat{\omega}$ can now be read off:²

$$\widehat{\omega} = \begin{pmatrix} 0 & -\frac{\cot\theta}{a}\epsilon^\varphi \\ \frac{\cot\theta}{a}\epsilon^\varphi & 0 \end{pmatrix}.$$

A straightforward exterior differentiation yields

$$d\widehat{\omega} = \begin{pmatrix} 0 & \frac{1}{a^2}\epsilon^\theta \wedge \epsilon^\varphi \\ -\frac{1}{a^2}\epsilon^\theta \wedge \epsilon^\varphi & 0 \end{pmatrix} = \frac{1}{a^2} \begin{pmatrix} 0 & \epsilon^\theta \wedge \epsilon^\varphi \\ -\epsilon^\theta \wedge \epsilon^\varphi & 0 \end{pmatrix}.$$

Similarly, $\widehat{\omega} \wedge \widehat{\omega} = 0$. Therefore, the curvature matrix is

$$\widehat{\Omega} = d\widehat{\omega} = \frac{1}{a^2} \begin{pmatrix} 0 & \epsilon^\theta \wedge \epsilon^\varphi \\ -\epsilon^\theta \wedge \epsilon^\varphi & 0 \end{pmatrix}.$$

The only independent component of the Riemann curvature tensor is $R_{\theta\varphi\theta\varphi} = 1/a^2$, which is constant, as expected for a spherical surface.

It is clear that when the g_{ij} in the expression for the line element are all constants for all points in the manifold, then ϵ^i will be proportional to dx^i and $d\epsilon^i = 0$, for all i . This immediately tells us that $\widehat{\omega} = 0$, and therefore $\widehat{\Omega} = 0$; that is, the manifold is flat. Thus, for $ds^2 = dx^2 + dy^2 + dz^2$, the space is flat. However, arc lengths of a flat space come in various guises with nontrivial coefficients. Does the curvature matrix $\widehat{\Omega}$ recognize the flat arc length, or is it possible to fool it into believing that it is privileged with a curvature when in reality the curvature is still zero? The following example shows that the curvature matrix can detect flatness no matter how disguised the line element is!

What is a flat manifold?

Example 37.1.12 In spherical coordinates, the line element (arc length) of the flat Euclidean space \mathbb{R}^3 is $ds^2 = dr^2 + r^2d\theta^2 + r^2\sin^2\theta d\varphi^2$. To calculate the curvature matrix, we first need an orthonormal set of one-forms. These are immediately obtained from the expression above:

$$\epsilon^r = dr, \quad \epsilon^\theta = r d\theta, \quad \epsilon^\varphi = r \sin\theta d\varphi.$$

Taking the exterior derivatives of these one-forms, we obtain

$$d\epsilon^r = d^2r = 0,$$

$$d\epsilon^\theta = d(rd\theta) = dr \wedge d\theta + r \underbrace{d^2\theta}_{=0} = \epsilon^r \wedge \left(\frac{\epsilon^\theta}{r}\right) = \frac{1}{r}\epsilon^r \wedge \epsilon^\theta,$$

$$\begin{aligned} d\epsilon^\varphi &= d(r \sin\theta) \wedge d\varphi = \sin\theta dr \wedge d\varphi + r \cos\theta d\theta \wedge d\varphi \\ &= \sin\theta \epsilon^r \wedge \left(\frac{\epsilon^\varphi}{r \sin\theta}\right) + r \cos\theta \left(\frac{\epsilon^\theta}{r}\right) \wedge \left(\frac{\epsilon^\varphi}{r \sin\theta}\right) \\ &= \frac{1}{r}\epsilon^r \wedge \epsilon^\varphi + \frac{\cot\theta}{r}\epsilon^\theta \wedge \epsilon^\varphi. \end{aligned}$$

²Note that $d\epsilon^\theta = 0$ does not imply $\omega_{12} = 0$.

We can now find the matrix of one-forms $\widehat{\omega}$. In calculating the elements of $\widehat{\omega}$, we remember that it is a skew-symmetric matrix, so all diagonal elements are zero. We also note that $d\epsilon^k = 0$ does not imply that $\omega^k_j = 0$. Keeping these facts in mind, we can easily obtain $\widehat{\omega}$ (the calculation is left as a problem for the reader):

$$\widehat{\omega} = \begin{pmatrix} 0 & -\frac{1}{r}\epsilon^\theta & -\frac{1}{r}\epsilon^\varphi \\ \frac{1}{r}\epsilon^\theta & 0 & -\frac{\cot\theta}{r}\epsilon^\varphi \\ \frac{1}{r}\epsilon^\varphi & \frac{\cot\theta}{r}\epsilon^\varphi & 0 \end{pmatrix}.$$

The exterior derivative of this matrix is found to be

$$d\widehat{\omega} = \begin{pmatrix} 0 & 0 & -\frac{\cot\theta}{r^2}\epsilon^\theta \wedge \epsilon^\varphi \\ 0 & 0 & \frac{1}{r^2}\epsilon^\theta \wedge \epsilon^\varphi \\ \frac{\cot\theta}{r^2}\epsilon^\theta \wedge \epsilon^\varphi & -\frac{1}{r^2}\epsilon^\theta \wedge \epsilon^\varphi & 0 \end{pmatrix},$$

which is precisely (the negative of) the exterior product $\widehat{\omega} \wedge \widehat{\omega}$, as the reader may wish to verify. Thus, $\widehat{\Omega} = d\widehat{\omega} + \widehat{\omega} \wedge \widehat{\omega} = 0$, and the space is indeed flat!

In all the foregoing examples, the curvature was calculated intrinsically. We never had to leave the space and go to a higher dimension to “see” the curvature. For example, in the case of the sphere, the only information we had was the line element in terms of the coordinates on the sphere. We never had to resort to any three-dimensional analysis to discover a globe embedded in the Euclidean \mathbb{R}^3 . As mentioned earlier, if a space has line elements with constant g_{ij} , then the Riemann curvature vanishes trivially. We have also seen an example in which the components of a metric tensor were by no means trivial, but $\widehat{\Omega}$ was smart enough to detect the flatness in disguise. Under what conditions can we choose coordinate systems in terms of which the line elements have $g_{ij} = \delta_{ij}$? To answer this question we need the following lemma (proved in [Flan 89, pp. 135–136]):

Lemma 37.1.13 *If $\widehat{\omega}$ is a matrix of 1-forms such that $d\widehat{\omega} + \widehat{\omega} \wedge \widehat{\omega} = 0$, then there exists an orthogonal matrix A such that $dA = A\widehat{\omega}$.*

The question raised above is intimately related to the connection between coordinate and orthonormal frames. We have seen the usefulness of both. Coordinate frames, due to the existence of the related coordinate *functions*, are useful for many analytical calculations, for example in Hamiltonian dynamics. Orthonormal frames are useful because of the simplicity of expressions inherent in all orthonormal vectors. Furthermore, we saw how curvature was easily calculated once we constructed orthonormal dual frames. Naturally, we would like to have both. Is it possible to construct frames that are both coordinate and orthonormal? The following theorem answers this question:

Theorem 37.1.14 *Let M be a Riemannian manifold. Then M is flat, i.e., $\widehat{\Omega} = 0$ if and only if there exists a local coordinate system $\{x^i\}$ for which $\{\partial_i\}$ is an orthonormal basis.*

Proof The existence of orthonormal coordinate frames implies that $\{dx^i\}$ are orthonormal. Thus, we can use them to find the curvature. But since $d(dx^i) = 0$ for all i , it follows from Eq. (37.12) that $\omega^i_j = 0$ and $\widehat{\omega} = 0$. So the curvature must vanish.

Conversely, suppose that $\widehat{\Omega} = 0$. Then by Lemma 37.1.13, there exists an orthogonal matrix A such that $dA = A\widehat{\omega}$. Now we define the one-form column matrix τ by $\tau = A\epsilon$, where ϵ is the column matrix of 1-forms ϵ^i . Then, using Eq. (37.12) in matrix form, we have

$$d\tau = d(A\epsilon) = dA \wedge \epsilon + A d\epsilon = (A\widehat{\omega}) \wedge \epsilon - A(\widehat{\omega} \wedge \epsilon) = 0.$$

Thus, $d\tau^i = 0$ for all i . By Theorem 28.5.15 there must exist zero-forms (functions) x^i such that $\tau^i = dx^i$. These x^i are the coordinates we are after. The basis $\{\partial_i\}$ is obtained using the inverse of A (see the discussion following Proposition 26.1.1). Since A is orthogonal, both $\{dx^i\}$ and $\{\partial_i\}$ are orthonormal bases. □

37.2 Isometries and Killing Vector Fields

We have already defined isometries for inner product spaces. The natural vector space structure on tangent spaces, plus the introduction of metrics on manifolds, leads in a natural way to the isometric mappings of manifolds.

Definition 37.2.1 Let M and N be Riemannian manifolds with metrics \mathbf{g}_M and \mathbf{g}_N , respectively. The smooth map $\psi : M \rightarrow N$ is called **isometric at** $P \in M$ if $\mathbf{g}_M(\mathbf{X}, \mathbf{Y}) = \mathbf{g}_N(\psi_*\mathbf{X}, \psi_*\mathbf{Y})$ for all $\mathbf{X}, \mathbf{Y} \in \mathcal{T}_P(M)$. An **isometry** of M to N is a bijective smooth map that is isometric at every point of M , in which case we have $\mathbf{g}_M = \mathbf{g}_N \circ \psi_*$. isometry defined

Of special interest are isometries $\psi : M \rightarrow M$ of a single manifold. These happen to be a subgroup of $\text{Diff}(M)$, the group of diffeomorphisms of M . In the subgroup of isometries, we concentrate on the one-parameter groups of transformations. These define (and are defined by) certain vector fields: Isometries of a manifold form a subgroup of $\text{Diff}(M)$.

Definition 37.2.2 Let $\mathbf{X} \in \mathcal{X}(M)$ be a vector field with integral curve F_t . Then \mathbf{X} is called a **Killing vector field** if F_t is an isometry of M . Killing vector field

The following proposition follows immediately from the definition of the Lie derivative [Eq. (28.29)].

Proposition 37.2.3 A vector field $\mathbf{X} \in \mathcal{X}(M)$ is a Killing vector field if and only if $L_{\mathbf{X}}\mathbf{g} = 0$.

Choosing a coordinate system $\{x^i\}$, we write $\mathbf{g} = g_{ij}dx^i \otimes dx^j$ and conclude that $X^j \partial_j$ is a Killing vector field if and only if

$$\begin{aligned} 0 &= L_{\mathbf{X}}(g_{ij}dx^i \otimes dx^j) \\ &= \mathbf{X}(g_{ij})dx^i \otimes dx^j + g_{ij}(L_{\mathbf{X}}dx^i) \otimes dx^j + g_{ij}dx^i \otimes (L_{\mathbf{X}}dx^j). \end{aligned}$$

Killing equation Using Eq. (28.33) for the 1-form dx^k , we obtain the **Killing equation**

$$X^k \partial_k g_{ij} + \partial_i X^k g_{kj} + \partial_j X^k g_{ki} = 0. \tag{37.18}$$

If in Eq. (36.38) we replace \mathbf{T} with \mathbf{g} and \mathbf{u} with \mathbf{X} , where \mathbf{X} is a Killing vector field, we obtain

$$0 = 0 + g_{ij} [(\nabla_{\mathbf{e}_k} \mathbf{X})^i \boldsymbol{\epsilon}^k \otimes \boldsymbol{\epsilon}^j + (\nabla_{\mathbf{e}_k} \mathbf{X})^j \boldsymbol{\epsilon}^i \otimes \boldsymbol{\epsilon}^k], \tag{37.19}$$

where we have assumed that the covariant derivative is compatible with the metric tensor, i.e., that it is the Levi-Civita covariant derivative. The reader may check that Eq. (37.19) leads to

Killing equation in terms of covariant derivative

$$X_{j;k} + X_{k;j} = 0. \tag{37.20}$$

This is another form of Killing equation.

Proposition 37.2.4 *If \mathbf{X} is a Killing vector field, then its inner product with the tangent to any geodesic is constant along that geodesic, i.e., if \mathbf{u} is such a tangent, then $\nabla_{\mathbf{u}}[\mathbf{g}(\mathbf{u}, \mathbf{X})] = 0$.*

Proof We write the desired covariant derivative in component form,

$$\begin{aligned} u^k (g_{ij} u^i X^j)_{;k} &= u^k \underbrace{g_{ij;k}}_{=0} u^i X^j + u^k g_{ij} \underbrace{u^i_{;k}}_{=0} X^j + u^k g_{ij} u^i X^j_{;k} \\ &= \frac{1}{2} \underbrace{(X_{i;k} + X_{k;i})}_{=0 \text{ by (37.20)}} u^i u^k, \end{aligned}$$

where the first term vanishes by assumption of the compatibility of the metric and the covariant derivative, and the second term by the geodesic equation. □

Example 37.2.5 In a flat m -dimensional manifold we can choose an orthonormal coordinate frame (Theorem 37.1.14), so that the Killing equation becomes

$$\partial_i X_j + \partial_j X_i = 0. \tag{37.21}$$

Setting $i = j$, we see that $\partial_j X_j = 0$ (no sum). Differentiating Eq. (37.21) with respect to x^i , we obtain

$$\partial_i^2 X_j + \partial_j \underbrace{\partial_i X_i}_{=0} = 0 \Rightarrow \partial_i^2 X_j = 0 \quad \forall i, j.$$

Therefore, X_j is linear in x^i , i.e., $X_j = a_{jk}x^k + b_j$ with a_{jk} and b_j arbitrary. Inserting this in (37.21), we get $a_{ij} + a_{ji} = 0$. The Killing vector is then

$$\mathbf{X} = (a^i_j x^j + b^i) \partial_i = \frac{1}{2} a^i_j (x^j \partial_i - x^i \partial_j) + b^i \partial_i.$$

The first term is clearly the generator of a rotation and the second term that of translation. Altogether, there are $m(m - 1)/2$ rotations and m translations. So the total number of independent Killing vectors is $m(m + 1)/2$. Manifolds that have this many Killing vectors are called **maximally symmetric spaces**.

Using Eqs. (28.34) and (28.35) one can show that the set of Killing vector fields on a manifold form a vector subspace of $\mathcal{X}(M)$, and that if \mathbf{X} and \mathbf{Y} are Killing vector fields, then so is $[\mathbf{X}, \mathbf{Y}]$. Thus,

Box 37.2.6 *The set of Killing vector fields forms a Lie algebra.*

Example 37.2.7 From $\mathbf{g} = d\theta \otimes d\theta + \sin^2 \theta d\varphi \otimes d\varphi$, the metric of the unit sphere S^2 , one writes the Killing equations

$$\begin{aligned} \partial_\theta X_\theta + \partial_\theta X_\theta &= 0, \\ \partial_\varphi X_\varphi + \partial_\varphi X_\varphi + 2 \sin \theta \cos \theta X_\theta &= 0, \\ \partial_\theta X_\varphi + \partial_\varphi X_\theta - 2 \cot \theta X_\varphi &= 0. \end{aligned} \tag{37.22}$$

The first equation implies that $X_\theta = f(\varphi)$, a function of φ only. Substitution in the second equation yields

$$X_\varphi = -\frac{1}{2} F(\varphi) \sin 2\theta + g(\theta), \quad \text{where } f(\varphi) = \frac{dF}{d\varphi}.$$

Inserting this in the third equation of (37.22), we obtain

$$-F(\varphi) \cos 2\theta + \frac{dg}{d\theta} + \frac{df}{d\varphi} + 2 \cot \theta \left[\frac{1}{2} F(\varphi) \sin 2\theta - g(\theta) \right] = 0,$$

or

$$\left[\frac{dg}{d\theta} - 2 \cot \theta g(\theta) \right] + \left[\frac{df}{d\varphi} + F(\varphi) \right] = 0.$$

For this equation to hold for all θ and φ , we must have

$$\frac{dg}{d\theta} - 2 \cot \theta g(\theta) = C = -\frac{df}{d\varphi} - F(\varphi),$$

where C is a constant. This gives

$$g(\theta) = (C_1 - C \cot \theta) \sin^2 \theta \quad \text{and} \quad f(\varphi) = X_\theta = A \sin \varphi + B \cos \varphi$$

with

$$X_\varphi = (A \cos \varphi - B \sin \varphi) \sin \theta \cos \theta + C_1 \sin^2 \theta.$$

A general Killing vector field is thus given by

$$\mathbf{X} = X^\theta \partial_\theta + X^\varphi \partial_\varphi = AL_y - BL_x + C_1 L_z,$$

where

$$L_x = -\cos \varphi \partial_\theta + \cot \theta \sin \varphi \partial_\varphi,$$

$$L_y = \sin \varphi \partial_\theta + \cot \theta \cos \varphi \partial_\varphi,$$

$$L_z = \partial_\varphi$$

are the generators of $SO(3)$.

Sometimes it is useful to relax the complete invariance of the metric tensor under the diffeomorphism of a manifold induced by a vector field and allow a change of scale in the metric. More precisely, we consider vector fields \mathbf{X} whose flow F_t changes the metric of M . So $F_{t*} \mathbf{g} = e^{\phi(t)} \mathbf{g}$, where ϕ is a real-valued function on M that is also dependent on the parameter t . Such a transformation keeps angles unchanged but rescales all lengths. In analogy with those of the complex plane with the same property, we call such transformations **conformal transformations**. A vector field that generates a conformal transformation will satisfy

discussion of conformal transformations and conformal Killing vector fields

$$X^k \partial_k g_{ij} + \partial_i X^k g_{kj} + \partial_j X^k g_{ki} = -\psi g_{ij}, \quad \psi = \left. \frac{\partial \phi}{\partial t} \right|_{t=0}, \quad (37.23)$$

and is called a **conformal Killing vector field**.

We now specialize to a flat m -dimensional manifold and choose an orthonormal coordinate frame (Theorem 37.1.14). Then Eq. (37.23) becomes

$$\partial_i X_j + \partial_j X_i = -\psi g_{ij}. \quad (37.24)$$

Remember Einstein's summation convention!

Multiply both sides by g^{ij} and sum over i to obtain

$$2\partial^i X_i = -m\psi \implies \partial^i X_i = -\frac{m}{2}\psi, \quad m = \dim M.$$

Apply ∂^i to both sides of Eq. (37.24) and sum over i . This yields

$$\partial^i \partial_i X_j + \partial_j \underbrace{\partial^i X_i}_{-\frac{m}{2}\psi} = -\partial_j \psi \implies \partial^i \partial_i X_j = \frac{1}{2}(m-2)\partial_j \psi. \quad (37.25)$$

Differentiate both sides of the second equation in (37.25) with respect to x^k and symmetrize the result in j and k to obtain

$$(m-2)\partial_j \partial_k \psi = \partial^i \partial_i (\partial_k X_j + \partial_j X_k) = -g_{jk} \partial^i \partial_i \psi.$$

Raising the index j and contracting it with k gives $\partial^i \partial_i \psi = 0$ if $m \neq 1$. It follows that

$$(m - 2)\partial_j \partial_k \psi = 0. \tag{37.26}$$

Equations (37.24), (37.25), and (37.26) determine both ψ and X_j if $m \neq 2$. It follows from Eq. (37.26) that ψ is linear in x , and, consequently [from (37.24)], that X_i is at most quadratic in x . The most general solution to Eq. (37.24) satisfying (37.25) and (37.26) is

$$X^j(x) = b^j + \varepsilon x^j + a^j_k x^k + c^j x^k x_k - 2c_k x^k x^j, \tag{37.27}$$

where $a_{ij} = -a_{ji}$ and indices of the constants are raised and lowered as usual.

Equation (37.27) gives the generators of an $[(m + 1)(m + 2)/2]$ -parameter group of transformations on \mathbb{R}^m , $m \neq 2$ called the **conformal group**. The reader should note that translation (represented by the parameters b^j) and rotations (represented by the parameters a_{ij}) are included in this group. The other finite (as opposed to infinitesimal) transformations of coordinates can be obtained by using Eq. (29.30). For example, the finite transformation generated by the parameter ε is given by the solution to the DE $dx'^j/dt = x'^j$, which is $x'^j = e^t x^j$, or $x'^j = e^\varepsilon x^j$, and is called a **dilatation** of coordinates. Similarly, the finite transformation generated by the parameter c_i is given by the solution to the DE $dx'^j/dc_i = \delta^{ij} x'^k x'_k - 2x'^i x'^j$, or

$$x'^i = \frac{x^i - c^i x^2}{1 - 2c \cdot x + c^2 x^2}, \quad \text{where } c \cdot x \equiv c^k x_k, \quad c^2 \equiv c \cdot c, \quad x^2 \equiv x \cdot x,$$

which is called **inversion**, or the **special conformal transformation**. Equations (37.25), and (37.26) place no restriction on ψ (and therefore on X_i) when $m = 2$. This means that

conformal group

dilatation

inversion, or special conformal transformation

Box 37.2.8 *The conformal group is infinite-dimensional for \mathbb{R}^2 .*

In fact, we encountered the conformal transformations of \mathbb{R}^2 in the context of complex analysis, where we showed that *any* (therefore, infinitely many) analytic function is a conformal transformation of $\mathbb{C} \cong \mathbb{R}^2$. The conformal group of \mathbb{R}^2 has important applications in string theory and statistical mechanics, but we shall not pursue them here.

37.3 Geodesic Deviation and Curvature

Geodesics are the straight lines of general manifolds on which, for example, free particles move. If \mathbf{u} represents the tangent to a given geodesic, one can say that $\nabla_{\mathbf{u}} \mathbf{u} = 0$ is the equation of motion of a free particle. In flat spaces, the relative velocity of any pair of free particles will not change, so that their

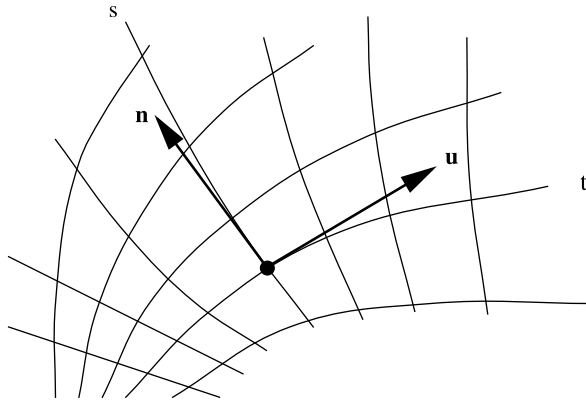

Fig. 37.1 A region of the manifold and the two-dimensional surface defined by s and t

relative acceleration is always zero. In general, however, due to the effects of curvature, we expect a nonzero acceleration. Let us elaborate on this.

Consider some region of the manifold through whose points geodesics can be drawn in various directions. Concentrate on one geodesic and its neighboring geodesics. Let t designate the parameter that locates points of the geodesic. Let s be a continuous parameter that labels different geodesics (see Fig. 37.1). One can connect the points on some neighboring geodesics corresponding to the same value of t and obtain a curve parametrized by s . The collection of all geodesics that pass through all points of this curve form a two-dimensional submanifold with coordinates t and s . Each such geodesic is thus described by the geodesic equation $\nabla_{\mathbf{u}}\mathbf{u} = 0$ with $\mathbf{u} = \partial/\partial t$ (because t is a coordinate). Furthermore, as we hop from one geodesic to its neighbor, the geodesic equation does not change; i.e., the geodesic equation is independent of s . Translated into the language of calculus, this means that differentiation of the geodesic equation with respect to s will give zero. Translated into the higher-level language of tensor analysis, it means that covariant differentiation of the geodesic equation will yield zero. We write this final translation as $\nabla_{\mathbf{n}}(\nabla_{\mathbf{u}}\mathbf{u}) = 0$ where $\mathbf{n} \equiv \partial/\partial s$. This can also be written as

$$0 = \nabla_{\mathbf{n}}\nabla_{\mathbf{u}}\mathbf{u} = \nabla_{\mathbf{u}}\nabla_{\mathbf{n}}\mathbf{u} + [\nabla_{\mathbf{n}}, \nabla_{\mathbf{u}}]\mathbf{u} = \nabla_{\mathbf{u}}(\nabla_{\mathbf{u}}\mathbf{n} + [\mathbf{n}, \mathbf{u}]) + [\nabla_{\mathbf{n}}, \nabla_{\mathbf{u}}]\mathbf{u},$$

where we have used the first property of Proposition 36.1.6. Using the fact that \mathbf{n} and \mathbf{u} are coordinate frames, we conclude that $[\mathbf{n}, \mathbf{u}] = 0$, which in conjunction with the second equation of Theorem 36.2.16, yields

$$\nabla_{\mathbf{u}}\nabla_{\mathbf{u}}\mathbf{n} + \mathbf{R}(\mathbf{n}, \mathbf{u})\mathbf{u} = 0. \tag{37.28}$$

relative acceleration The first term can be interpreted as the **relative acceleration** of two geodesic curves (or free particles), because $\nabla_{\mathbf{u}}$ is the generalization of the derivative with respect to t , and $\nabla_{\mathbf{u}}\mathbf{n}$ is interpreted as relative velocity. In a flat manifold, the relative acceleration for any pair of free particles is zero. When curvature is present, it produces a nonzero relative acceleration.

By writing $\mathbf{u} = u^i \partial_i$ and $\mathbf{n} = n^k \partial_k$ and substituting in Eq. (37.28), we arrive at the **equation of geodesic deviation** in coordinate form:

equation of geodesic deviation

$$u^i u^j n^k R^m{}_{ijk} = \frac{d^2 n^m}{dt^2} + \frac{d}{dt} (u^j n^k \Gamma^m{}_{jk}) + u^j \frac{dn^k}{dt} \Gamma^m{}_{jk} + u^i u^j n^k \Gamma^l{}_{jk} \Gamma^m{}_{il}, \tag{37.29}$$

where we have used the fact that $u^i \partial_i f = df/dt$ for any function defined on the manifold.

The chain that connects relative acceleration to curvature has another link that connects the latter two to gravity. From a Newtonian standpoint, gravity is the only force that accelerates all objects at the same rate (equivalence principle). From a geometric standpoint, this property allows one to include gravity in the structure of space-time: An object in free fall is considered “free”, and its path, a geodesic. Locally, this is in fact a better picture of reality, because inside a laboratory in free fall (such as a space shuttle in orbit around earth) one actually verifies the first law of motion on all objects floating in midair. One need not include an external phenomenon called gravity. Gravity becomes part of the fabric of space-time.

But how *does* gravity manifest itself? Is there any observable effect that can indicate the presence of gravity, or by a mere transfer to a freely falling frame have we been able to completely eliminate gravity? The second alternative would be strange indeed, because the source of gravity is matter, and if we eliminate gravity completely, we have to eliminate matter as well! If the gravitational field were homogeneous, one *could* eliminate it—and the matter that produces it as well, but no such gravitational field exists. The inhomogeneity of gravitational fields has indeed an observable effect. Consider two test particles that are falling freely toward the source of gravity on two different radii. As they get closer and closer to the center, their relative distance—in fact, their relative velocity—changes: They experience a relative acceleration. Since as we saw in Eq. (37.28), relative acceleration is related to curvature, we conclude that

Einstein’s interpretation of gravity

Box 37.3.1 *Gravity manifests itself by giving space-time a curvature.*

This is Einstein’s interpretation of gravity. From a Newtonian standpoint, the relative acceleration is caused by the inhomogeneity of the gravitational field. Such inhomogeneity (in the field of the Moon and the Sun) is responsible for tidal waves. That is why the curvature term in Eq. (37.28) is also called the **tide-producing** gravitational force.

37.3.1 Newtonian Gravity

The equivalence principle, relating gravity with the curvature of space-time, is not unique to Einstein. What is unique to him is combining that principle with the assumption of *local Lorentz geometry*, i.e., local validity of special

relativity. Cartan also used the equivalence principle to reformulate Newtonian gravity in the language of geometry. Rewrite Newton's second law of motion as

$$\mathbf{F} = m\mathbf{a} \Rightarrow \mathbf{a} = -\nabla\Phi \Rightarrow \frac{\partial^2 x^j}{\partial t^2} + \frac{\partial\Phi}{\partial x^j} = 0,$$

where Φ is the gravitational potential (potential energy per unit mass). The Newtonian universal time is a parameter that has two degrees of freedom: Its origin and its unit of measurement are arbitrary. Thus, one can change t to $t = a\tau + b$ without changing the physics of gravity. Taking this freedom into account, one can write

$$\frac{d^2 t}{d\tau^2} = 0, \quad \frac{d^2 x^j}{d\tau^2} + \frac{\partial\Phi}{\partial x^j} \left(\frac{dt}{d\tau} \right)^2 = 0. \quad (37.30)$$

Comparing this with the geodesic equation, we can read off the nonzero connection coefficients:

$$\Gamma^j_{00} = \frac{\partial\Phi}{\partial x^j}, \quad j = 1, 2, 3. \quad (37.31)$$

Inserting these in the second formula of Eq. (36.23), we find the nonzero components of Riemann curvature tensor:

$$R^j_{0k0} = -R^j_{00k} = \frac{\partial^2\Phi}{\partial x^j \partial x^k}. \quad (37.32)$$

Contraction of the two nonzero indices leads to the Laplacian of gravitational potential

$$R^j_{0j0} = \frac{\partial^2\Phi}{\partial x^2} + \frac{\partial^2\Phi}{\partial y^2} + \frac{\partial^2\Phi}{\partial z^2} = \nabla^2\Phi.$$

Therefore, the Poisson equation for gravitational potential can be written in terms of the curvature tensor:

$$R_{00} \equiv R^j_{0j0} = 4\pi G\rho, \quad (37.33)$$

Ricci tensor defined where we have introduced the **Ricci tensor**, defined as

$$R_{ik} \equiv R^j_{ijk}. \quad (37.34)$$

Equations (37.31), (37.32), and (37.33) plus the law of geodesic motion describe the full content of Newtonian gravitational theory in the geometric language of tensors.³

³The classic and comprehensive book *Gravitation*, by Misner, Thorne, and Wheeler, has a thorough discussion of Newtonian gravity in the language of geometry in Chap. 13 and is highly recommended.

It is instructive to discover the relation between curvature and gravity directly from the equation of geodesic deviation as applied to Newtonian gravity. The geodesic equation is the equation of motion:

$$\frac{\partial^2 x^j}{\partial t^2} + \frac{\partial \Phi}{\partial x^j} = 0.$$

Differentiate this equation with respect to the parameter s , noting that $\partial/\partial s = n^i \partial/\partial x^i$:

$$\frac{\partial}{\partial s} \left(\frac{\partial^2 x^j}{\partial t^2} \right) + \frac{\partial}{\partial s} \left(\frac{\partial \Phi}{\partial x^j} \right) = 0 \Rightarrow \frac{\partial^2}{\partial t^2} \left(\frac{\partial x^j}{\partial s} \right) + n^i \frac{\partial}{\partial x^i} \left(\frac{\partial \Phi}{\partial x^j} \right) = 0.$$

Now note that $\partial x^j/\partial s = n^i \partial x^j/\partial x^i = n^j$. So, we obtain

$$\frac{\partial^2 n^j}{\partial t^2} + n^i \frac{\partial^2 \Phi}{\partial x^i \partial x^j} = 0.$$

This is equivalent to Eq. (37.28), and one recognizes the second term as the tide-producing (or the curvature) term.

37.4 General Theory of Relativity

No treatment of (semi)Riemannian geometry is complete without a discussion of the general theory of relativity. That is why we shall devote this last section of the current chapter to a brief exposition of this theory.

We have seen that Newtonian gravity can be translated into the language of differential geometry by identifying the gravitational tidal effects with the curvature of space-time. This straightforward interpretation of Newtonian gravity, in particular the retention of the Euclidean metric and the universality of time, leads to no new physical effect. Furthermore, it is inconsistent with the special theory of relativity, which mixes space and time coordinates via Lorentz transformations. Einstein's general theory of relativity (GTR) combines the equivalence principle (that freely falling objects move on geodesics) with the local validity of the special theory of relativity (that the metric of space-time reduces to the Lorentz-Minkowski metric of the special theory of relativity).

37.4.1 Einstein's Equation

An important tensor that can be constructed out of Riemann curvature tensor and the metric tensor is the **Einstein tensor \mathbf{G}** , which is related to the Ricci tensor defined in Eq. (37.34). To derive the Einstein tensor, first note that the Ricci tensor is symmetric in its indices (see Problem 37.21):

Einstein tensor

$$R_{ij} = R_{ji}. \tag{37.35}$$

Next, define the **curvature scalar** as

curvature scalar defined

$$R \equiv R^i_i \equiv g^{ij} R_{ij}. \quad (37.36)$$

Now, contract i with m in Eq. (36.46) and use the antisymmetry of the Riemann tensor in its last two indices to obtain

$$R^i_{jkl;i} + R_{jk;l} - R_{jl;k} = 0.$$

Finally, contract j and l and use the antisymmetry of the Riemann tensor in its first as well as its last two indices to get $2R^i_{k;i} - R_{;k} = 0$, or $R_{jk;i} - \frac{1}{2}g_{jk}R_{;i} = 0$. Summarizing the foregoing discussion, we write

$$\nabla \cdot \mathbf{G} = 0, \quad \text{where} \quad G_{ij} \equiv R_{ij} - \frac{1}{2}g_{ij}R. \quad (37.37)$$

Historical Notes

Karl Schwarzschild (1873–1916) was the eldest of five sons and one daughter born to Moses Martin Schwarzschild and his wife, Henrietta Sabel. His father was a prosperous member of the business community in Frankfurt, with Jewish forbears in that city traced back to the sixteenth century.

From his mother, a vivacious, warm person, Karl undoubtedly inherited his happy, outgoing personality, and from his father, a capacity for sustained hard work. His childhood was spent in comfortable circumstances among a large circle of relatives, whose interests included art and music; he was the first to become a scientist.

After attending a Jewish primary school, Schwarzschild entered the municipal gymnasium in Frankfurt at the age of eleven. His curiosity about the heavens was first manifested then: He saved his allowance and bought lenses to make a telescope. Indulging this interest, his father introduced him to a friend, J. Epstein, a mathematician who had a private observatory. With Epstein's son (later professor of mathematics at the University of Strasbourg), Schwarzschild learned to use a telescope and studied mathematics of a more advanced type than he was getting in school. His precocious mastery of celestial mechanics resulted in two papers on double star orbits, written when he was barely sixteen.

In 1891 Schwarzschild began two years of study at the University of Strasbourg, where Ernst Becker, director of the observatory, guided the development of his skills in practical astronomy—skills that later were to form a solid underpinning for his masterful mathematical abilities.

At age twenty Schwarzschild went to the University of Munich. Three years later, in 1896, he obtained his Ph.D., *summa cum laude*. His dissertation was an application of Poincaré's theory of stable configurations in rotating bodies to several astronomical problems, including tidal deformation in satellites and the validity of Laplace's suggestion as to how the solar system had originated. Before graduating, Schwarzschild also found time to do some practical work with Michelson's interferometer.

At a meeting of the German Astronomical Society in Heidelberg in 1900 he discussed the possibility that space was non-Euclidean. In the same year he published a paper giving a lower limit for the radius of curvature of space as 2500 light years. From 1901 until 1909 he was professor at Göttingen, where he collaborated with Klein, Hilbert, and Minkowski, publishing on electrodynamics and geometrical optics. In 1906, he studied the transport of energy through a star by radiation.

From Göttingen he went to Potsdam, but in 1914 he volunteered for military service. He served in Belgium, France, and Russia. While in Russia he wrote two papers on Einstein's relativity theory and one on Planck's quantum theory. The quantum theory paper explained that the Stark effect could be proved from the postulates of quantum theory.

Schwarzschild's relativity papers give the first exact solution of Einstein's general gravitational equations, giving an understanding of the geometry of space near a point mass. He also made the first study of black holes, showing that bodies of sufficiently large mass would have an escape velocity exceeding the speed of light and so could not be seen. However, he contracted an illness while in Russia and died soon after returning home.



Karl Schwarzschild
1873–1916

The automatic vanishing of the divergence of the *symmetric* Einstein tensor has an important consequence in the field equation of GTR. It is reminiscent of a similar situation in electromagnetism, in which the vanishing of the divergence of the fields leads to the conservation of the electric charge, the source of electromagnetic fields.⁴

Just as Maxwell’s equations are a generalization of the static electricity of Coulomb to a dynamical theory, Einstein’s GTR is the generalization of Newtonian static gravity to a dynamical theory. As this generalization ought to agree with the successes of the Newtonian gravity, Eq. (37.37) must agree with (37.33). The bold step taken by Einstein was to generalize this relation involving only a single component of the Ricci tensor to a full tensor equation. The natural tensor to be used as the source of gravitation is the **stress energy tensor**⁵

$$T^{\mu\nu} \equiv (\rho + p)u^\mu u^\nu + pg^{\mu\nu}, \quad \text{or} \quad \mathbf{T} = (\rho + p)\mathbf{u} \otimes \mathbf{u} + p\mathbf{g},$$

where the source is treated as a fluid with density ρ , four-velocity \mathbf{u} , and pressure p . So, Einstein suggested the equation $\mathbf{G} = \kappa\mathbf{T}$ as the generalization of Newton’s universal law of gravitation. Note that $\nabla \cdot \mathbf{G} = 0$ automatically guarantees mass-energy conservation as in Maxwell’s theory of electromagnetism. Problem 37.23 calculates κ to be 8π in units in which the universal gravitational constant and the speed of light are set equal to unity. We therefore have

$$\mathbf{G} = 8\pi\mathbf{T}, \quad \text{or} \quad \mathbf{R} - \frac{1}{2}R\mathbf{g} = 8\pi[(\rho + p)\mathbf{u} \otimes \mathbf{u} + p\mathbf{g}]. \quad (37.38)$$

Einstein’s equation of the general theory of relativity

This is **Einstein’s equation** of the general theory of relativity.

The Einstein tensor \mathbf{G} is nearly the only symmetric second-rank tensor made out of the Riemann and metric tensors that is divergence free. The only other tensor with the same properties is $\mathbf{G} + \Lambda\mathbf{g}$, where Λ is the so-called **cosmological constant** (see Problem 37.24). When in 1922, Einstein applied his GTR to the universe itself, he found that the universe ought to be expanding. Being a firm believer in Nature, he changed his equation to $\mathbf{G} + \Lambda\mathbf{g} = 8\pi\mathbf{T}$ to suppress the unobserved prediction of the expansion of the universe. Later, when the expansion was observed by Hubble, Einstein referred to this mutilation of his GTR as “the biggest blunder of my life”.

cosmological constant

With the discovery of an accelerating universe, there has been a revival of interest in the cosmological constant. However, the fact that it is so small, and a lack of fundamental explanation of this fact, has become a challenge in cosmology. Perhaps a unification of GTR with quantum—a quantum theory of gravity—is a solution. But this unification has resisted an indisputable

⁴It was Maxwell’s discovery of the inconsistency of the pre-Maxwellian equations of electromagnetism with charge conservation that prompted him to change not only the fourth equation (to make the entire set of equations consistent with the charge conservation), but also the course of human history.

⁵In GTR, it is customary to use the convention that Greek indices run from 0 to 3, i.e., they include both space and time, while Latin indices encompass only the space components.

solution (of the type that Dirac found in unifying STR with quantum theory) despite the effort of some of the most brilliant minds in contemporary physics.

Historical Notes

Aleksandr Aleksandrovich Friedmann (1888–1925) was born into a musical family—his father, Aleksandr Friedmann, being a composer and his mother, Ludmila Vojáčka, the daughter of the Czech composer Hynek Vojáček.

In 1906 Friedmann graduated from the gymnasium with the gold medal and immediately enrolled in the mathematics section of the department of physics and mathematics of St. Petersburg University. While still a student, he wrote a number of unpublished scientific papers, one of which was awarded a gold medal by the department. After graduation from the university in 1910, Friedmann was retained in the department to prepare for the teaching profession.



Aleksandr
Aleksandrovich
Friedmann 1888–1925

In the fall of 1914, Friedmann volunteered for service in an aviation detachment, in which he worked, first on the northern front and later on other fronts, to organize aerologic and aeronavigational services. While at the front, Friedmann often participated in military flights as an aircraft observer. In the summer of 1917 he was appointed a section chief in Russia's first factory for the manufacture of measuring instruments used in aviation; he later became director of the factory. Friedmann had to relinquish this post because of the onset of heart disease. From 1918 until 1920, he was professor in the department of theoretical mechanics of Perm University.

In 1920 he returned to Petrograd and worked at the main physics observatory of the Academy of Sciences, first as head of the mathematics department and later, shortly before his death, as director of the observatory. Friedmann's scientific activity was concentrated in the areas of theoretical meteorology and hydromechanics, where he demonstrated his mathematical talent and his unwavering strife for, and ability to attain, the concrete, practical application of solutions to theoretical problems.

Friedmann made a valuable contribution to Einstein's general theory of relativity. As always, his interest was not limited simply to familiarizing himself with this new field of science but led to his own remarkable investigations. Friedmann's work on the theory of relativity dealt with the cosmological problem. In his paper "Über die Krümmung des Raumes" (1922), he outlined the fundamental ideas of his cosmology: the supposition concerning the homogeneity of the distribution of matter in space and the consequent homogeneity and isotropy of space-time. This theory is especially important because it leads to a sufficiently correct explanation of the fundamental phenomenon known as the "red shift". Einstein himself thought that the cosmological solution to the equations of a field had to be static and had to lead to a closed model of the universe. Friedmann discarded both conditions and arrived at an independent solution.

Friedmann's interest in the theory of relativity was by no means a passing fancy. In the last years of his life, together with V.K. Frederiks, he began work on a multivolume text on modern physics. The first book, *The World as Space and Time*, is devoted to the theory of relativity, knowledge of which Friedmann considered one of the cornerstones of an education in physics.

In addition to his scientific work, Friedmann taught courses in higher mathematics and theoretical mechanics at various colleges in Petrograd. He found time to create new and original courses, brilliant in their form and exceedingly varied in their content. Friedmann's unique course in theoretical mechanics combined mathematical precision and logical continuity with original procedural and physical trends.

Friedmann died of typhoid fever at the age of thirty-seven. In 1931, he was posthumously awarded the Lenin Prize for his outstanding scientific work.

37.4.2 Static Spherically Symmetric Solutions

The general theory of relativity as given in Eq. (37.38) has been strikingly successful in predicting the spacetime⁶ structure of our universe. It predicts the expansion of the universe, and by time-reversed extrapolation, the big bang cosmology; it predicts the existence of black holes and other final products of stellar collapse; and on a less grandiose scale, it explains the small precession of Mercury, the bending of light in the gravitational field of the Sun, and the gravitational redshift. We shall not discuss the solution of Einstein's equation in any detail. However, due to its simplicity and its use of geometric arguments, we shall consider the solution to Einstein's equation exterior to a static spherically symmetric distribution of mass.

Let us first translate the two adjectives used in the last sentence into a geometric language. Take static first. We call a phenomenon "static" if at different instants it "looks the same". Thus, a static solution of Einstein's equation is a spacetime manifold that "looks the same" for all time. In the language of geometry "looks the same" means isometric, because metric is the essence of the geometry of space-time. In Euclidean physics, time can be thought of as an axis at each point (moment) of which one can assign a three-dimensional space corresponding to the "spatial universe" at that moment. In the general theory of relativity, space and time can be mixed, but the character of time as a parameter remains unaltered. Therefore, instead of an axis—a straight line—we pick a curve, a parametric map from the real line to the manifold of space-time. This curve must be *timelike*, so that locally, when curvature is ignored and special relativity becomes a good approximation, we do not violate causality. The curve must also have the property that at each point of it, the space-time manifold has the same metric. Moreover, we need to demand that at each point of this curve, the spatial part of the space-time is orthogonal to the curve.

Definition 37.4.1 A spacetime is **stationary** if there exists a one-parameter group of isometries F_t , called **time translation isometries**, whose Killing vector fields ξ are timelike for all t : $\mathbf{g}(\xi, \xi) > 0$. If in addition, there exists a spacelike hypersurface Σ that is orthogonal to orbits (curves) of the isometries, we say that the spacetime is **static**.

stationary and static spacetimes; time translation isometries

We can simplify the solution to Einstein's equation by invoking the symmetry of spacetime discussed above in our choice of coordinates. Let P be a point of the spacetime manifold located in a neighborhood of some spacelike hypersurface Σ as shown in Fig. 37.2. Through P passes a single orbit of the isometry, which starts at a point Q of Σ . Let t , the so-called **Killing parameter**, stand for the parameter corresponding to the point P with $t = 0$ being the parameter of Q . On the spacelike hypersurface Σ , choose arbitrary coordinates $\{x^i\}$ for Q . Assign the coordinates $(t \equiv x^0, x^1, x^2, x^3)$ to P . Since F_t does not change the metric, $\Sigma_t \equiv F_t \Sigma$, the translation of Σ by F_t ,

Killing parameter

⁶The reader may be surprised to see the two words "space" and "time" juxtaposed with no hyphen; but this is common practice in relativity.

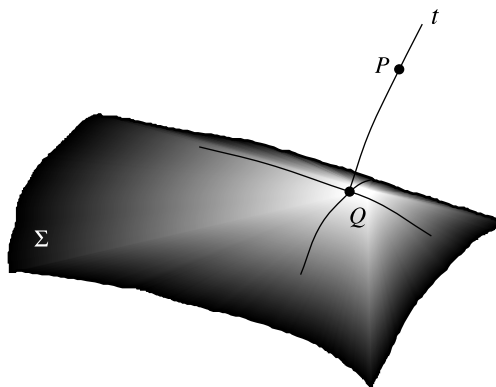

Fig. 37.2 The coordinates appropriate for a stationary spacetime

is also orthogonal to the orbit of the isometry. Moreover, the components of the metric in this coordinate system cannot be dependent on the Killing parameter t . Thus, in this coordinate system, the spacetime metric takes the form

$$\mathbf{g} = g_{00}dt \otimes dt - \sum_{i,j=1}^3 g_{ij}dx^i \otimes dx^j. \tag{37.39}$$

spherically symmetric spacetimes

Definition 37.4.2 A spacetime is **spherically symmetric** if its isometry group contains a subgroup isomorphic to $SO(3)$ and the orbits of this group are two-dimensional spheres.

In other words, if we think of isometries as the action of some abstract group, then this group must contain $SO(3)$ as a subgroup. Since $SO(3)$ is isomorphic to the group of rotations, we conclude that the metric should be rotationally invariant. The time-translation Killing vector field ξ must be orthogonal to the orbits of $SO(3)$, because otherwise the generators of $SO(3)$ can change the projection of ξ on the spheres and destroy the rotational invariance. Therefore, the 2-dimensional spheres must lie entirely in the hypersurfaces Σ_t . Now, we can write down a static spherically symmetric metric in terms of appropriate coordinates as follows. Choose the spherical coordinates (θ, φ) for the 2-spheres, and write the metric of this sphere as

$$\mathbf{g}_2 = r^2 d\theta \otimes d\theta + r^2 \sin^2 \theta d\varphi \otimes d\varphi,$$

where r is the “radius” of the 2-sphere. Choose the third spatial coordinate to be orthogonal to this sphere, i.e., r . Rotational symmetry now implies that the components of the metric must be independent of θ and φ . The final form of the metric based entirely on the assumed symmetries is

$$\mathbf{g} = f(r)dt \otimes dt - h(r)dr \otimes dr - r^2(d\theta \otimes d\theta + \sin^2 \theta d\varphi \otimes d\varphi). \tag{37.40}$$

We have reduced the problem of finding ten unknown functions $\{g_{\mu\nu}\}_{\mu,\nu=0}^3$ of four variables $\{x^\mu\}_{\mu=0}^3$ to that of two functions f and h of one variable. The remaining task is to calculate the Ricci tensor corresponding to Eq. (37.40), substitute it in Einstein’s equation (with the RHS equal to zero), and solve the resulting differential equation for f and h . We shall not pursue this further here, and we refer the reader to textbooks on general relativity (see, for example, [Wald 84, pp. 121–124]). The final result is the so-called **Schwarzschild solution**, which is

Schwarzschild solution of Einstein’s equation

$$\mathbf{g} = \left(1 - \frac{2M}{r}\right) dt \otimes dt - \left(1 - \frac{2M}{r}\right)^{-1} dr \otimes dr - r^2(d\theta \otimes d\theta + \sin^2\theta d\varphi \otimes d\varphi), \tag{37.41}$$

where M is the total mass of the gravitating body, and the natural units of GTR, in which $G = 1 = c$, have been used.

A remarkable feature of the Schwarzschild solution is that the metric components have singularities at $r = 2M$ and at $r = 0$. It turns out that the first singularity is due to the choice of coordinates (analogous to the singularity at $r = 0, \theta = 0, \pi$, and $\varphi = 0$ in spherical coordinates of \mathbb{R}^3), while the second is a true singularity of spacetime. The first singularity occurs at the so-called **Schwarzschild radius** whose numerical value is given by

Schwarzschild radius

$$r_S = \frac{2GM}{c^2} \approx 3 \frac{M}{M_\odot} \text{ km},$$

where $M_\odot = 2 \times 10^{30}$ kg is the mass of the Sun. Therefore, for an ordinary body such as the Earth, planets, and a typical star, the Schwarzschild radius is well inside the body where the Schwarzschild solution is not applicable.

If we relax the assumption of staticity, we get the following theorem (for a proof, see [Misn 73, p. 843]):

Theorem 37.4.3 (Birkhoff’s theorem) *The Schwarzschild solution is the only spherically symmetric solution of Einstein’s equation in vacuum.*

A corollary to this theorem is that all spherically symmetric solutions of Einstein’s equation in vacuum are static. This is analogous to the fact that the Coulomb solution is the only spherically symmetric solution to Maxwell’s equations in vacuum. It can be interpreted as the statement that in gravity, as in electromagnetism, there is no monopole “radiation”.

All spherically symmetric solutions of Einstein’s equation in vacuum are static.

37.4.3 Schwarzschild Geodesics

With the metric available to us, we can, in principle, solve the geodesic equations [Eq. (36.44)] and obtain the trajectories of freely falling particles. However, a more elegant way is to make further use of the symmetries to

eliminate variables. In particular, Proposition 37.2.4 is extremely useful in this endeavor. Consider first $\mathbf{g}(\partial_\theta, \mathbf{u})$ where \mathbf{u} is the 4-velocity (tangent to the geodesic). In the coordinates we are using, this yields

$$\mathbf{g}(\partial_\theta, \mathbf{u}) = \mathbf{g}(\partial_\theta, \dot{x}^\mu \partial_\mu) = \dot{x}^\mu \underbrace{\mathbf{g}(\partial_\theta, \partial_\mu)}_{r^2 \delta_{\theta\mu}} = r^2 \dot{\theta}.$$

This quantity (because of Proposition 37.2.4 and the fact that ∂_θ is a Killing vector field) is a constant of the motion, and its initial value will be an attribute of the particle during its entire motion. We assign zero to this constant, i.e., we assume that initially $\dot{\theta} = 0$. This is possible, because by rotating our spacetime—an allowed operation due to rotational symmetry—we take the equatorial plane $\theta = \pi/2$ to be the initial plane of the motion. Then the motion will be confined to this plane, because $\dot{\theta} = 0$ for all time.

For the parameter of the geodesic equation, choose proper time τ if the geodesic is timelike (massive particles), and any (affine) parameter if the geodesic is null (massless particles such as photons). Then $g_{\mu\nu} \dot{x}^\mu \dot{x}^\nu = \kappa$, where

$$\kappa = \begin{cases} 1 & \text{for timelike geodesics,} \\ 0 & \text{for null geodesics.} \end{cases} \quad (37.42)$$

In terms of our chosen coordinates (with $\theta = \pi/2$), we have

$$\kappa = g_{\mu\nu} \dot{x}^\mu \dot{x}^\nu = (1 - 2M/r) \dot{t}^2 - (1 - 2M/r)^{-1} \dot{r}^2 - r^2 \dot{\phi}^2. \quad (37.43)$$

Next, we apply Proposition 37.2.4 to the time translation Killing vector and write

$$E = g_{\mu\nu} \dot{x}^\mu \xi^\nu = (1 - 2M/r) \dot{t}, \quad (37.44)$$

where E is a constant of the motion and $\xi = \partial_t$. In the case of massive particles, as $r \rightarrow \infty$, i.e., as we approach special relativity, E becomes \dot{t} , which is the rest energy of a particle of unit mass.⁷ Therefore, it is natural to interpret E for finite r as the total energy (including gravitational potential energy) per unit mass of a particle on a geodesic.

Finally, the other rotational Killing vector field ∂_ϕ gives another constant of motion,

$$L = \mathbf{g}(\partial_\phi, \mathbf{u}) = r^2 \dot{\phi}, \quad (37.45)$$

which can be interpreted as the angular momentum of the particle. This reduces to Kepler's second law: Equal areas are swept out in equal times, in the limit of Newtonian (or weak) gravity. However, in strong gravitational fields, spacetime is not Euclidean, and Eq. (37.45) cannot be interpreted as "areas swept out". Nevertheless, it is interesting that the "form" of Kepler's second law does not change even in strong fields.

⁷Recall that the 4-momentum of special relativity is $p^\mu = m \dot{x}^\mu$.

Solving for \dot{r} and $\dot{\phi}$ from (37.44) and (37.45) and inserting the result in (37.43), we obtain

$$\frac{1}{2}\dot{r}^2 + \frac{1}{2}\left(1 - \frac{2M}{r}\right)\left(\frac{L^2}{r^2} + \kappa\right) = \frac{1}{2}E^2. \quad (37.46)$$

It follows from this equation that the radial motion of a particle on a geodesic is the same as that of a unit mass particle of energy $E^2/2$ in ordinary one-dimensional nonrelativistic mechanics moving in an effective potential

$$V(r) = \frac{1}{2}\left(1 - \frac{2M}{r}\right)\left(\frac{L^2}{r^2} + \kappa\right) = \frac{1}{2}\kappa - \kappa\frac{M}{r} + \frac{L^2}{2r^2} - \frac{ML^2}{r^3}. \quad (37.47)$$

Once we solve Eq. (37.46) for the radial motion in this effective potential, we can find the angular motion and the time coordinate change from (37.44) and (37.45). The new feature provided by GTR is that in the radial equation of motion, in addition to the “Newtonian term” $-\kappa M/r$ and the “centrifugal barrier” $L^2/2r^2$, we have the new term $-ML^2/r^3$, which, although a small correction for large r , will dominate over the centrifugal barrier term for small r .

Massive Particle

Let us consider first the massive particle case, $\kappa = 1$. The extrema of the effective potential are given by

$$Mr^2 - L^2r + 3ML^2 = 0 \Rightarrow R_{\pm} = \frac{L^2 \pm \sqrt{L^4 - 12L^2M^2}}{2M}. \quad (37.48)$$

Thus, if $L^2 < 12M^2$, no extrema exist, and a particle heading toward the center of attraction, will fall directly to the Schwarzschild radius $r = 2M$, the zero of the effective potential, and finally into the spacetime singularity $r = 0$.

For $L^2 > 12M^2$, the reader may check that R_+ is a minimum of $V(r)$, while R_- is a maximum. It follows that stable (unstable) circular orbits exist at the radius $r = R_+$ ($r = R_-$). In the Newtonian limit of $M \ll L$, we get $R_+ \approx L^2/M$, which agrees with the calculation in Newtonian gravity (Problem 37.26). Furthermore, Eq. (37.48) puts a restriction of $R_+ > 6M$ on R_+ and $3M < R_- < 6M$ on R_- . This places the planets of the Sun safely in the region of stable circular orbits.

If a massive particle is displaced slightly from its stable equilibrium radius R_+ , it will oscillate radially with a frequency ω_r given by⁸

$$\omega_r^2 = \left. \frac{d^2V}{dr^2} \right|_{r=R_+} = \frac{M(R_+ - 6M)}{R_+^4 - 3MR_+^3}.$$

⁸In the Taylor expansion of any potential $V(r)$ about the equilibrium position r_0 of a particle (of unit mass), it is the second derivative term that resembles Hooke's potential, $\frac{1}{2}kx^2$ with $k = (d^2V/dr^2)_{r_0}$.

On the other hand, the orbital frequency is given by Eq. (37.45),

$$\omega_\varphi^2 = \frac{L^2}{R_+^4} = \frac{M}{R_+^3 - 3MR_+^2},$$

where L^2 has been calculated from (37.48) and inserted in this equation. In the Newtonian limit of $M \ll R_+$, we have $\omega_\varphi \approx \omega_r \approx M/R_+^3$. If $\omega_\varphi = \omega_r$, the particle will return to a given value of r in exactly one orbital period and the orbit will close. The difference between ω_φ and ω_r in GTR means that the orbit will precess at a rate of

$$\omega_p = \omega_\varphi - \omega_r = (1 - \omega_r/\omega_\varphi)\omega_\varphi = -[(1 - 6M/R_+)^{1/2} - 1]\omega_\varphi,$$

which in the limit of $M \ll R_+$ reduces to

$$\omega_p \approx \frac{3M^{3/2}}{R_+^{5/2}} = \frac{3(GM)^{3/2}}{c^2 R_+^{5/2}},$$

where in the last equality, we restored the factors of G and c . If we include the eccentricity e and denote the semimajor axis of the elliptical orbit by a , then the formula above becomes (see [Misn 73, p. 1110])

$$\omega_p \approx \frac{3(GM)^{3/2}}{c^2(1 - e^2)a^{5/2}}. \quad (37.49)$$

Due to its proximity to the Sun, Mercury shows the largest precession frequency, which, after subtracting all other effects such as perturbations due to other planets, is 43 seconds of arc per century. This residual precession rate had been observed prior to the formulation of GTR and had been an unexplained mystery. Its explanation was one of the most dramatic early successes of GTR.

Massless Particle

We now consider the null geodesics. With $\kappa = 0$ in Eq. (37.47), the effective potential becomes

$$V(r) = \frac{L^2}{2r^2} - \frac{ML^2}{r^3}, \quad (37.50)$$

which has only a *maximum* at $r = R_{\max} \equiv 3M$. It follows that in GTR, unstable circular orbits of photons exist at $r = 3M$, and that strong gravity has significant effect on the propagation of light.

The minimum energy required to overcome the potential barrier (and avoid falling into the infinitely deep potential well) is given by

$$\frac{1}{2}E^2 = V(R_{\max}) = \frac{L^2}{54M^2} \Rightarrow \frac{L^2}{E^2} = 27M^2.$$

In flat spacetime, L/E is precisely the impact parameter b of a photon, i.e., the distance of closest approach to the origin. Thus the Schwarzschild geometry will capture any photon sent toward it if the impact parameter is

less than $b_c \equiv \sqrt{27}M$. Hence, the cross section for photon capture is

$$\sigma \equiv \pi b_c^2 = 27\pi M^2.$$

To analyze the bending of light, we write Eq. (37.46) as

$$\frac{1}{2} \left(\frac{dr}{d\varphi} \right)^2 \dot{\varphi}^2 + V(r) = \frac{1}{2} E^2.$$

Substituting for $\dot{\varphi}$ from Eq. (37.45) and writing the resulting DE in terms of a new variable $u = M/r$, we obtain

$$\left(\frac{du}{d\varphi} \right)^2 + u^2(1 - 2u) = \frac{b^2}{M^2}, \quad b \equiv \frac{E}{L},$$

where we used Eq. (37.50) for the effective potential. Differentiating this with respect to φ , we finally get the second-order DE,

$$\frac{d^2u}{d\varphi^2} + u = 3u^2. \quad (37.51)$$

In the large-impact-parameter or small- u approximation, we can ignore the second-order term on the RHS and solve for u . This will give the equation of a line in polar coordinates. Substituting this solution on the RHS of Eq. (37.51) and solving the resulting equation yields the deviation from a straight line with a deflection angle of

$$\Delta\varphi \approx \frac{4M}{b} = \frac{4GM}{bc^2}, \quad (37.52)$$

where we have restored the G 's and the c 's in the last step.

For a light ray grazing the Sun, $b = R_\odot = 7 \times 10^8$ m and $M = M_\odot = 2 \times 10^{30}$ kg, so that Eq. (37.52) predicts a deflection of 1.747 seconds of arc. This bending of starlight passing near the Sun has been observed many times, beginning with the 1919 expedition led by Eddington. Because of the intrinsic difficulty of such measurements, these observations confirm GTR only to within 10 % accuracy. However, the bending of radio waves emitted by quasars has been measured to an accuracy of 1 %, and the result has been shown to be in agreement with Eq. (37.52) to within this accuracy.

The last topic we want to discuss, a beautiful illustration of Proposition 37.2.4 is the **gravitational redshift**. Let O_1 and O_2 be two static observers (by which we mean that they each move on an integral curve of the Killing vector field ξ). It follows that the 4-velocities \mathbf{u}_1 and \mathbf{u}_2 of the observers are proportional to ξ . Since \mathbf{u}_1 and \mathbf{u}_2 have unit lengths, we have

$$\mathbf{u}_i = \frac{\xi_i}{\sqrt{\mathbf{g}(\xi_i, \xi_i)}}, \quad i = 1, 2.$$

Suppose O_1 emits a light beam and O_2 receives it. Since light travels on a geodesic, Proposition 37.2.4 gives

$$\mathbf{g}(\mathbf{u}, \xi_1) = \mathbf{g}(\mathbf{u}, \xi_2), \quad (37.53)$$

gravitational redshift
discussed

where \mathbf{u} is tangent to the light trajectory (or the light signal's 4-velocity). The frequency of light for any observer is the time component of its 4-velocity, and because the 4-velocity of an observer has the form $(1, 0, 0, 0)$ in the frame of that observer, we can write this invariantly as

$$\omega_i = \mathbf{g}(\mathbf{u}, \mathbf{u}_i) = \frac{\mathbf{g}(\mathbf{u}, \xi_i)}{\sqrt{\mathbf{g}(\xi_i, \xi_i)}}, \quad i = 1, 2.$$

In particular, using Eq. (37.53), we obtain

$$\frac{\omega_1}{\omega_2} = \frac{\mathbf{g}(\mathbf{u}, \mathbf{u}_1)}{\mathbf{g}(\mathbf{u}, \mathbf{u}_2)} = \frac{\mathbf{g}(\mathbf{u}, \xi_1)/\sqrt{\mathbf{g}(\xi_1, \xi_1)}}{\mathbf{g}(\mathbf{u}, \xi_2)/\sqrt{\mathbf{g}(\xi_2, \xi_2)}} = \frac{\sqrt{\mathbf{g}(\xi_2, \xi_2)}}{\sqrt{\mathbf{g}(\xi_1, \xi_1)}} = \sqrt{\frac{1 - 2M/r_2}{1 - 2M/r_1}},$$

where we used $\mathbf{g}(\xi, \xi) = g_{00} = (1 - 2M/r)$ for the Schwarzschild space-time, and r_1 and r_2 are the radial coordinates of the observers O_1 and O_2 , respectively. In terms of wavelengths, we have

$$\frac{\lambda_1}{\lambda_2} = \sqrt{\frac{1 - 2M/r_1}{1 - 2M/r_2}}. \quad (37.54)$$

It follows from Eq. (37.54) that as light moves toward regions of weak gravity ($r_2 > r_1$), the wavelength increases ($\lambda_2 > \lambda_1$), i.e., it will be “red-shifted”. This makes sense, because an increase in distance from the center implies an increase in the gravitational potential energy, and, therefore, a decrease in a photon's energy $\hbar\omega$. Pound and Rebka used the Mössbauer effect in 1960 to measure the change in the wavelength of a beam of light as it falls down a tower on the surface of the Earth. They found that, to within the 1 % experimental accuracy, the GTR prediction of the gravitational redshift was in agreement with their measurement.

37.5 Problems

37.1 Show that a derivative ∇_X defined by Eq. (37.2) satisfies the four conditions of Proposition 36.2.11.

37.2 Using Eq. (36.6) show that the Levi-Civita connection satisfies

$$\mathbf{Z}(\mathbf{g}(\mathbf{X}, \mathbf{Y})) = \mathbf{g}(\nabla_Z \mathbf{X}, \mathbf{Y}) + \mathbf{g}(\mathbf{X}, \nabla_Z \mathbf{Y}).$$

Write down similar relations for $\mathbf{X}(\mathbf{g}(\mathbf{Y}, \mathbf{Z}))$ and $\mathbf{Y}(\mathbf{g}(\mathbf{X}, \mathbf{Z}))$. Now compute

$$\mathbf{X}(\mathbf{g}(\mathbf{Y}, \mathbf{Z})) + \mathbf{Y}(\mathbf{g}(\mathbf{X}, \mathbf{Z})) - \mathbf{Z}(\mathbf{g}(\mathbf{X}, \mathbf{Y}))$$

and use the fact that Levi-Civita connection is torsion-free to arrive at (37.2).

37.3 Derive Eq. (37.3) by letting $\mathbf{X} = \partial_i$, $\mathbf{Y} = \partial_j$, and $\mathbf{Z} = \partial_k$ in Eq. (37.2).

37.4 Let \mathbf{A} and \mathbf{B} be matrices whose elements are one-forms. Show that

$$(\mathbf{A} \wedge \mathbf{B})^t = -\mathbf{B}^t \wedge \mathbf{A}^t.$$

37.5 Write Eq. (37.13) in component form and derive Eq. (37.15).

37.6 Find $d\hat{\omega}$ if

$$\hat{\omega} = \begin{pmatrix} 0 & -\cot\theta\epsilon^\varphi \\ \cot\theta\epsilon^\varphi & 0 \end{pmatrix},$$

where (θ, φ) are coordinates on the unit sphere S^2 .

37.7 Find the curvature of the two-dimensional space whose arc length is given by $ds^2 = dx^2 + x^2dy^2$.

37.8 Find the curvature of the three-dimensional space whose arc length is given by $ds^2 = dx^2 + x^2dy^2 + dz^2$.

37.9 Find the curvature tensors of the Friedmann and Schwarzschild spaces given in Example 37.1.8.

37.10 Consider the Euclidean space \mathbb{R}^3 .

- Show that in this space, the composite operator $d \circ *$ gives the curl of a vector when the vector is written as components of a two-form.
- Similarly, show that $* \circ d$ is the divergence operator for one-forms.
- Use these results and the procedure of Example 37.1.9 to find expressions for the curl and the divergence of a vector in curvilinear coordinates.

37.11 Prove the statement in Box 37.1.2.

37.12 Start with $d^2x^i/dt^2 = 0$, the geodesic equations in Cartesian coordinates. Transform these equations to spherical coordinates (r, θ, φ) using $x = r \sin\theta \cos\varphi$, $y = r \sin\theta \sin\varphi$, and $z = r \cos\theta$, and the chain rule. From these equations read off the connection coefficients in spherical coordinates [refer to Eq. (36.44)]. Now use Eq. (36.33) and Definition 36.2.22 to evaluate the divergence of a vector.

37.13 Find the geodesics of a manifold whose arc element is $ds^2 = dx^2 + dy^2 + dz^2$.

37.14 Find the geodesics of the metric $ds^2 = dx^2 + x^2dy^2$.

37.15 Find the differential equation for the geodesics of the surface of a sphere of radius a having the line element $ds^2 = a^2d\theta^2 + a^2\sin^2\theta d\varphi^2$. Verify that

$$A \cos\varphi + B \sin\varphi + \cot\theta = 0$$

is the intersection of a plane passing through the origin and the sphere. Also, show that it is a solution of the differential equation of the geodesics. Hence, the geodesics of a sphere are great circles.

37.16 The Riemann normal coordinates are given by $x^i = a^i t$. For each set of a^i , one obtains a different set of geodesics. Thus, we can think of a^i as the parameters that distinguish among the geodesics.

- (a) By keeping all a^i (and t) fixed except the j th one and using the definition of tangent to a curve, show that $\mathbf{n}_j = t \partial_j$, where \mathbf{n}_j is (one of) the \mathbf{n} 's appearing in the equation of geodesic deviation.
- (b) Substitute (a) plus $u^i = \dot{x}^i = a^i$ in Eq. (37.29) to show that

$$R^m{}_{ijk} + R^m{}_{jik} = 3(\Gamma^m{}_{ik,j} + \Gamma^m{}_{jk,i}).$$

Substitute for one of the Γ 's on the RHS using Eq. (36.45).

- (c) Now use the cyclic property of the lower indices of the curvature tensor to show that

$$\Gamma^m{}_{ij,k} = -\frac{1}{3}(R^m{}_{ijk} + R^m{}_{jik}).$$

37.17 Let ω be a 1-form and \mathbf{v} a vector.

- (a) Show that the covariant and Lie derivatives, when applied to a 1-form, are related by

$$\langle L_{\mathbf{u}}\omega, \mathbf{v} \rangle = \langle \nabla_{\mathbf{u}}\omega, \mathbf{v} \rangle + \langle \omega, \nabla_{\mathbf{v}}\mathbf{u} \rangle.$$

- (b) Use this to derive the identity

$$(L_{\mathbf{u}}\omega)_i = (\nabla_{\mathbf{u}}\omega)_i + \omega_j (\nabla_{\mathbf{e}_i}\mathbf{u})^j.$$

37.18 Show that Eq. (37.19) leads to Eq. (37.20).

37.19 Show that a vector field that generates a conformal transformation satisfies

$$X^k \partial_k g_{ij} + \partial_i X^k g_{kj} + \partial_j X^k g_{ki} = -\psi g_{ij}.$$

37.20 Use the symmetries of R_{ijkl} [Eqs. (37.14) and (37.15)] to show that $R_{ijkl} = R_{klij}$ and $R_{[ijkl]} = 0$.

37.21 Use the symmetry properties of Riemann curvature tensor to show that

- (a) $R^i{}_{ijk} = R_{mij}{}^j = 0$, and
- (b) $R_{ij} = R_{ji}$.
- (c) Show that $R^i{}_{jkl;i} + R_{jk;l} - R_{jl;k} = 0$, and conclude that $\nabla \cdot \mathbf{G} = 0$, or, in component form, $G_i{}^k{}_{;k} = 0$.

37.22 Show that in an n -dimensional manifold without metric the number of independent components of the Riemann curvature tensor is

$$\frac{n^3(n-1)}{2} - \frac{n^2(n-1)(n-2)}{6} = \frac{n^2(n^2-1)}{3}.$$

If the manifold has a metric, the number of components reduces to

$$\left[\frac{n(n-1)}{2} \right]^2 - \frac{n^2(n-1)(n-2)}{6} = \frac{n^2(n^2-1)}{12}.$$

37.23 Consider Einstein's equation $\mathbf{R} - \frac{1}{2}R\mathbf{g} = \kappa\mathbf{T}$.

- Take the trace of both sides of the equation to obtain $R = -\kappa T_{\mu}^{\mu} \equiv -\kappa T$.
- Use (a) to obtain $R_{00} = \frac{1}{2}\kappa(T_{00} + T_j^j)$.
- Now use the fact that in Newtonian limit $T_{ij} \ll T_{00} \approx \rho$ to conclude that agreement of Einstein's and Newton's gravity demands that $\kappa = 8\pi$ in units in which the universal gravitational constant is unity.

37.24 Let E_{ij} be the most general second-rank symmetric tensor constructed from the metric and Riemann curvature tensors that is linear in the curvature tensor.

- Show that

$$E_{ij} = aR_{ij} + bg_{ij}R + \Lambda g_{ij},$$

where a , b , and Λ are constants.

- Show that E_{ij} has a vanishing divergence if and only if $b = -\frac{1}{2}a$.
- Show that in addition, E_{ij} vanishes in flat space-time if and only if $\Lambda = 0$.

37.25 Show that R_+ and R_- , as given by Eq. (37.48) are, respectively, a minimum and a maximum of $V(r)$.

37.26 Use Newton's second law of motion to show that in a circular orbit of radius R , we have $L^2 = GMR$.

37.27 Show that $R_+ > 6M$ and $3M < R_- < 6M$, where R_{\pm} are given by Eq. (37.48).

37.28 Calculate the energy of a circular orbit using Eq. (37.46), and show that

$$E(R) = \frac{R - 2M}{\sqrt{R^2 - 3MR}},$$

where $R = R_{\pm}$.

37.29 Show that the radial frequency of oscillation of a massive particle in a stable orbit of radius R_+ is given by

$$\omega_r^2 = \frac{M(R_+ - 6M)}{R_+^4 - 3MR_+}.$$

37.30 Derive Eq. (37.52) from Eq. (37.51).

References

- [Abra 85] Abraham, R., Marsden, J.: *Foundations of Mechanics*, 2nd edn. Addison-Wesley, Reading (1985)
- [Abra 88] Abraham, R., Marsden, J., Ratiu, T.: *Manifolds, Tensor Analysis, and Applications*, 2nd edn. Springer, Berlin (1988)
- [Axle 96] Axler, S.: *Linear Algebra Done Right*. Springer, Berlin (1996)
- [Baru 86] Barut, A., Raczka, R.: *Theory of Group Representations and Applications*. World Scientific, Singapore (1986)
- [Benn 87] Benn, I.M., Tucker, R.W.: *An Introduction to Spinors and Geometry with Applications in Physics*. Adam Hilger, Bristol (1987)
- [Birk 77] Birkhoff, G., MacLane, S.: *Modern Algebra*, 4th edn. Macmillan, London (1977)
- [Birk 78] Birkhoff, G., Rota, G.-C.: *Ordinary Differential Equations*, 3rd edn. Wiley, New York (1978)
- [Bish 80] Bishop, R., Goldberg, S.: *Tensor Analysis on Manifolds*. Dover, New York (1980)
- [Ble 81] Bleecker, D.: *Gauge Theory and Variational Principles*. Addison-Wesley, Reading (1981)
- [Bly 90] Blyth, T.: *Module Theory*. Oxford University Press, Oxford (1990)
- [Boer 63] Boerner, H.: *Representation of Groups*. North-Holland, Amsterdam (1963)
- [Chur 74] Churchill, R., Verhey, R.: *Complex Variables and Applications*, 3rd edn. McGraw-Hill, New York (1974)
- [Cour 62] Courant, R., Hilbert, D.: *Methods of Mathematical Physics*, vol. 1. Interscience, New York (1962)
- [Denn 67] Dennery, P., Krzywicki, A.: *Mathematics for Physicists*. Harper and Row, New York (1967)
- [DeVi 90] DeVito, C.: *Functional Analysis and Linear Operator Theory*. Addison-Wesley, Reading (1990)
- [Flan 89] Flanders, H.: *Differential Forms with Applications to Physical Sciences*. Dover, New York (1989)
- [Frie 82] Friedman, A.: *Foundations of Modern Analysis*. Dover, New York (1982)
- [Fult 91] Fulton, W., Harris, J.: *Representation Theory*. Springer, Berlin (1991)
- [Grad 65] Gradshteyn, I., Ryzhik, I.: *Table of Integrals, Series, and Products*. Academic Press, New York (1965)
- [Greu 78] Greub, W.: *Multilinear Algebra*, 2nd edn. Springer, Berlin (1978)
- [Halm 58] Halmos, P.: *Finite Dimensional Vector Spaces*, 2nd edn. Van Nostrand, Princeton (1958)
- [Hame 89] Hamermesh, M.: *Group Theory and Its Application to Physical Problems*. Dover, New York (1989)
- [Hass 08] Hassani, S.: *Mathematical Methods for Students of Physics and Related Fields*, 2nd edn. Springer, Berlin (2008)
- [Hell 67] Hellwig, G.: *Differential Operators of Mathematical Physics*. Addison-Wesley, Reading (1967)
- [Hill 87] Hildebrand, F.: *Statistical Mechanics*. Dover, New York (1987)
- [Koba 63] Kobayashi, S., Nomizu, K.: *Foundations of Differential Geometry*, vol. I. Wiley, New York (1963)
- [Lang 85] Lang, S.: *Complex Analysis*, 2nd edn. Springer, Berlin (1985)

- [Lorr 88] Lorrain, P., Corson, D., Lorrain, F.: *Electromagnetic Fields and Waves*, 3rd edn. Freeman, New York (1988)
- [Mack 68] Mackey, G.: *Induced Representations*. Benjamin, Elmsford (1968)
- [Mari 80] Marion, J., Heald, M.: *Classical Electromagnetic Radiation*, 2nd edn. Academic Press, New York (1980)
- [Math 70] Mathews, J., Walker, R.: *Mathematical Methods of Physics*, 2nd edn. Benjamin, Elmsford (1970)
- [Mess 66] Messiah, A.: *Quantum Mechanics (2 volumes)*. Wiley, New York (1966)
- [Mill 68] Miller, W.: *Lie Theory and Special Functions*. Academic Press, New York (1968)
- [Misn 73] Misner, C., Thorne, K., Wheeler, J.: *Gravitation*. Freeman, New York (1973)
- [Olve 86] Olver, P.: *Application of Lie Groups to Differential Equations*. Springer, Berlin (1986)
- [Reed 80] Reed, M., Simon, B.: *Functional Analysis (4 volumes)*. Academic Press, New York (1980)
- [Rich 78] Richtmyer, R.: *Principles of Advanced Mathematical Physics*. Springer, Berlin (1978)
- [Rotm 84] Rotman, J.: *An Introduction to the Theory of Groups*, 3rd edn. Allyn and Bacon, Needham Heights (1984)
- [Saun 89] Saunders, D.: *The Geometry of Jet Bundles*. Cambridge University Press, Cambridge (1989)
- [Simm 83] Simmons, G.: *Introduction to Topology and Modern Analysis*. Krieger, Melbourne (1983)
- [Stak 79] Stakgold, I.: *Green's Functions and Boundary Value Problems*. Wiley, New York (1979)
- [Tric 55] Tricomi, F.: *Vorlesungen über Orthogonalreihen*. Springer, Berlin (1955)
- [Vara 84] Varadarajan, V.: *Lie Groups, Lie Algebras and Their Representations*. Springer, Berlin (1984)
- [Wald 84] Wald, R.: *General Relativity*. University of Chicago Press, Chicago (1984)
- [Warn 83] Warner, F.: *Foundations of Differentiable Manifolds and Lie Groups*. Springer, Berlin (1983)
- [Wein 95] Weinberg, S.: *The Quantum Theory of Fields (2 volumes)*. Cambridge University Press, Cambridge (1995)
- [Zeid 95] Zeidler, E.: *Applied Functional Analysis*. Springer, Berlin (1995)

Index

A

- Abel, 115, 246, 251, 301, 475, 523, 703
 - biography, 712
- Abelian group, 704
- Abelian Lie algebra, 937
- Abel's identity, 454
- Absolute convergence, 319
- Addition theorem for spherical harmonics, 412, 413
- Additive identity, 20
- Adjoint, 147, 171, 177, 434, 454, 495, 551, 564, 614, 618, 624, 675, 677, 754, 1092, 1102
 - classical, 56, 57, 155
 - matrix of, 152–155
 - differential operators, 433–436
 - formal, 612, 648
 - operator, 56, 57
- Adjoint action, 929
- Adjoint algebra, 944
- Adjoint boundary conditions, 615, 619
- Adjoint Green's function, 618
- Adjoint map, 926
- Adjoint of a matrix, 144
- Adjoint of an operator, 113
- Adjoint representation, 732
 - character, 737
- Affine group, 948
- Affine motion, 917
- Affine parameter, 1138
- Airy's DE, 456, 490
- Algebra, 63–72, 101, 119, 191, 398, 515, 740, 784, 797, 829, 891, 921, 942
 - antiderivation, 82, 829, 831, 889, 891
 - associative, 63
 - automorphism, 70
 - center, 64
 - central, 65
 - central simple, 79, 93, 845
 - Clifford, 800, 829–855
 - anticenter, 839–842
 - canonical element, 838, 839
 - center, 839–842
 - construction, 830–834
 - Dirac equation, 832–834
 - general classification, 843–846
 - homomorphism with other
 - algebras, 837, 838
 - isomorphisms, 842, 843
 - properties, 834–843
 - commutative, 63
 - complex numbers, 295
 - decomposition, 83–95
 - definition, 63
 - derivation, 81, 82, 99, 106, 868, 887, 891, 1124
 - derivation of, 80–83
 - derivation of an, 80
 - derived, 66
 - dimension of an, 63
 - epimorphism, 70
 - exterior, 794–801
 - factor, 77, 78
 - generator, 70
 - homomorphism, 70, 71
 - ideal, 73
 - involution, 72, 82, 836, 837, 839, 843, 848, 989, 990
 - isomorphism, 70
 - Lie, 915–936
 - monomorphism, 70
 - operator, 101–107
 - opposite, 66
 - polynomial, 95–97
 - quaternions, 69
 - representation, 125–131
 - semi-simple, 88–91, 92, 92, 94, 130, 764, 799, 844
 - simple, 76
 - classification, 92–95
 - structure constants, 68
 - symmetric, 791
 - tensor, 784
 - tensor product, 68
 - total matrix, 78–80
 - unital, 63
 - Algebra direct sum, 67
 - Algebra of endomorphisms, 67
 - Algebra of linear operators, 67
 - Algebra of polynomials, 67
 - Algebra tensor product, 68
 - Algebraic equation, 1010
 - symmetry group of, 1010

- Algebraic multiplicity, 174
- Analytic continuation, 372–378
 - SOLDE, 459
- Analytic function, 297–304
 - definition, 301
 - derivative, 297
 - derivatives as integrals, 316
 - entire, 301
 - poles of, 342
 - roots (zeros) of, 330
- Angular momentum, 25, 398, 933, 976
 - addition theorem, 973
 - commutation relation, 399
 - eigenvalues, 404
 - eigenvector, 406–413
 - intrinsic spin, 1073
 - operator, 398
 - eigenvalues, 401–405
 - in spherical coordinates, 401
 - orbital, 1073
 - quantum mechanics, 405
- Annihilator, 51, 61, 86
 - left, 73
 - right, 73
- Anticommutator, 111
- Antiderivation, 82, 829, 831, 889, 891
- Antisymmetric bilinear form, 707
- Antisymmetric representation, 732
- Antisymmetrizer, 793
- Antisymmetry, 793
- Arc length, 1146
- Associated bundle, 1084–1086
 - vector bundle, 1117–1120
 - vector field
 - horizontal, 1091
- Associated Legendre functions, 408
- Associative algebra, 63
- Asymptotic expansion, 385
- Atoms, 480–482
- Automorphism, 43, 74, 836, 841, 945, 1085, 1098, 1102
 - algebra, 70
 - group, 705
 - PFB, 1081
- Azimuthal symmetry, 411
- B**
- Baker-Campbell-Hausdorff formula, 110
- Banach space, 218, 1048
- Basis, 23
 - dual of, 51
 - dual of a, 782
 - oriented, 800
 - orthonormal, 32
 - standard, 23
 - transformation matrix, 149
- Becquerel, 896
- Bernoulli, 482, 1056
- Bessel, 246, 671, 1056
 - biography, 481
- Bessel DE, 432, 482
- Bessel equation, 466
 - Liouville substitution, 570
- Bessel function, 482–485, 586
 - asymptotic behavior, 502–505
 - large argument, 504
 - large order, 503
 - confluent hypergeometric, 483
 - first kind, 483
 - generating function, 499
 - integral representation of, 498–505
 - modified
 - first kind, 391, 484
 - second kind, 392, 484
 - oscillation of, 432
 - recurrence relation, 485
 - second kind, 483
 - spherical, 487, 593
 - third kind, 484
- Bessel imaginary (bei), 590
- Bessel inequality, 219
- Bessel real (ber), 590
- Beta function, 378–381
 - definition, 380
- Bianchi's identities, 1123
- Bianchi's identity, 1094
 - abelian case, 1095
- Bijjective map, 6
- Bilinear inner product
 - complex, 46
- Binary operation, 7
- Binomial theorem, 13
- Birkhoff's theorem, 1169
- Block diagonal, 171, 200
- Bohr radius, 481
- Bohr-Sommerfeld quantization, 452
- Bolzano, 11
- Bolzano-Weierstrass property, 522
- Bolzano-Weierstrass theorem, 522
- Boole, 755
- Boundary conditions
 - adjoint, 615
 - Dirichlet, 617, 642
 - general unmixed, 617
 - homogeneous, 611
 - mixed, 616
 - elliptic PDE, 673
 - Neumann, 617, 643
 - periodic, 571, 617
 - separated, 566
 - unmixed, 616
- Boundary functionals, 612
- Boundary point, 520
- Boundary value problem, 612, 635
 - Dirichlet, 642, 665–671
 - Neumann, 643, 671–673
- Bounded operator, 513–517
 - continuity, 514
- Bra, 20
- Branch cut, 366

- Brouwer, 957
- Bundle
 associated, 1084–1086
 vector bundle, 1117–1120
 Clifford, 1101
 cotangent, 882
 spinor, 1101
 tangent, 877
 tensor, 883
- Bundle of linear frames, 1084, 1120
 canonical form, 1121
- Bundle space, 1080
- BWHB theorem, 960
- C**
- Calculus of variations, 1047–1061
 symmetry groups, 1062–1065
- Canonical 1-form, 928
- Canonical basis, 802, 902
 SOLDE, 463
- Canonical coordinates, 902
- Canonical flat connection, 1095
- Canonical form, 1121
- Canonical transformation, 902, 907
- Cantor, 523, 792, 897
 biography, 10
- Cantor set, 12
- Cardinality, 10–12, 23
- Cartan, 896, 946, 1015
 biography, 799
- Cartan metric tensor, 945, 970
- Cartan subalgebra, 948
- Cartan's lemma, 798
- Cartesian product, 2, 7
- Cartesian vectors, 19
- Casimir operator, 969, 970, 971, 971,
 975–977, 979, 980
- Cauchy, 154, 340, 366, 475, 533, 581,
 640, 702, 1130
 biography, 301
- Cauchy data, 636
- Cauchy integral formula, 313
 for operators, 536
- Cauchy problem, 636
 ill-posed, 642
- Cauchy sequence, 9, 216, 526
- Cauchy-Goursat theorem, 310
- Cauchy-Riemann conditions, 298, 303
 differentiability, 300
- Cauchy's inequality, 336
- Cayley, 755, 799
- Cayley's theorem, 761
- Center, 64
- Center of a group, 708
- Central algebra, 75, 845
- Central force field, 25
- Central simple algebra, 93, 845
- Centralizer, 708
- Chain rule, 96
- Champollion, 267
- Character
 adjoint representation, 737
 compound, 736, 737
 conjugacy class, 736
 group and its subgroup, 743–746
 of a representation, 736
 simple, 736, 737
 symmetric group
 graphical construction, 767–774
- Character table, 743
 for S_2 , 745
 for S_3 , 745
- Characteristic hypersurface, 638
- Characteristic polynomial, 173, 182, 197,
 536, 558, 591, 626
 HNOLDE, 446
- Characteristic root, 173, 467
- Charged scalar field, 1114
- Chebyshev, 639
- Chebyshev polynomials, 253
- Chevalley, biography, 971
- Chevalley's theorem, 969
- Christoffel, biography, 1130
- Circle of convergence, 319
- Circuit matrix, 462, 463
- Circular heat-conducting plate, 600
- Classical adjoint, 56, 57, 155
 matrix of, 152–155
- Classical field theory
 conservation laws, 1069–1073
 Noether's theorem, 1069–1073
 symmetry, 1069–1073
- Classical orthogonal polynomial, 241–243
 classification, 244, 245
 generating functions, 257, 258
 recurrence relations, 245–248
- Classification of simple algebras, 92–95
- Clebsch, 246, 755
 biography, 753
- Clebsch-Gordan
 coefficients, 756, 757
 decomposition, 753–756, 774, 973
 series, 754, 757
- Clifford, 799
- Clifford algebra, 800, 829–855
 anticenter, 839–842
 canonical element, 838, 839
 center, 839–842
 conjugation involution, 837
 construction, 830–834
 degree involution, 836
 Dirac equation, 832–834
 even element, 835
 general classification, 843–846
 homomorphism with other algebras,
 837, 838
 isomorphisms, 842, 843
 odd element, 835
 properties, 834–843
 representation, 987–1006

- Pauli spin matrices, 997–1001
- Clifford algebra $\mathbf{C}_3^1(\mathbb{R})$, 852–855, 1004–1006
- Clifford algebra $\mathbf{C}_\mu^v(\mathbb{R})$, 846–855
 - classification, 851, 852
- Clifford algebra $\mathbf{C}_\mu^v(\mathbb{R})$
 - spin representation, 1003
 - spinor space of, 1003
- Clifford algebra $\mathbf{C}_\mu^v(\mathbb{R})$
 - standard basis, 1001
- Clifford algebra $\mathbf{C}_0^n(\mathbb{R})$
 - classification, 849, 850, 851
- Clifford algebra $\mathbf{C}_n^0(\mathbb{R})$
 - classification, 849, 850, 851
- Clifford group, 987–994
- Clifford product, 830
- Closed form, 894
- Closed subset, 520
- Closure, 520
- Codifferential, 900
 - covariant, 1108
- Codomain, 5
- Cofactor, 153, 155
- Commutative algebra, 63
- Commutative group, 704
- Commutative Lie algebra, 937
- Commutator, 106, 107
 - diagonalizability, 186
- Commutator subgroup, 707
- Compact Lie algebra, 945
- Compact Lie group
 - representation, 953–963
- Compact operator, 523–526
 - spectral theorem, 527–534
 - spectrum, 527
- Compact resolvent, 563–569
- Compact set, 519–523
- Compact subset, 522
- Compact support, 234, 898
- Comparison theorem, 430–432
- Complement of a set, 2
- Complete metric space, 10
- Complete o.n. sequence, 219
- Completeness relation, 123, 148, 220, 228, 658
- Complex coordinate space, 21
- Complex exponential function, 302
- Complex FOLDEs, 460–462
- Complex function, 295, 296
 - analytic, 301
 - analytic continuation, 372
 - branch cut, 366
 - branch point of, 365
 - Cauchy-Riemann conditions, 298
 - continuous, 296
 - derivatives as integrals, 315–319
 - entire, 301
 - essential singularity, 342
 - integration, 309–315
 - isolated singularity, 339
 - isolated zero, 330
 - meromorphic, 363
 - multivalued
 - branch, 367
 - Riemann sheet, 367
 - Riemann surface, 367
 - pole of order m , 342
 - power series, 319
 - circle of convergence, 319
 - principal part of, 342
 - removable singular point, 342
 - simple pole, 342
 - simple zero, 330
 - zero of order k , 329
- Complex $GL(V)$, 922
- Complex hyperbolic function, 303
- Complex plane
 - contour in, 309
 - curve in the, 309
 - multiply connected region, 312
 - path in the, 309
 - simply connected region, 312
- Complex potential, 305
- Complex series, 319–321
- Complex SOLDE, 463–469
- Complex structure, 45–48, 139, 163, 202
- Complex trigonometric function, 303
- Complex vector space, 20
- Complexification, 48, 102, 202
- Composition of maps, 5
- Compound character, 737
- Conducting cylindrical can, 586–588
- Confluent hypergeometric function, 478–485
 - definition, 479
 - integral representation of, 497, 498
- Conformal group, 1159
 - in 2 dimensions, 1159
- Conformal Killing vector, 1158
- Conformal map, 304–308, 309
 - definition, 305
 - translation, 306
- Conformal transformation, 1158
 - special, 1159
- Conic sections, 196
- Conjugacy class, 711, 736, 737
- Conjugate, 711
- Conjugate subgroup, 707
- Conjugation
 - operators, 113, 114
- Conjunct, 612, 614, 628
- Connection, 1086–1091
 - flat, 1095, 1096
 - Levi-Civita, 1145
 - linear, 1120–1140
 - definition, 1121
 - local expression, 1087–1089
 - matrix structure group, 1096, 1097
 - metric, 1143–1155
 - vector bundle, 1117–1120

- Connection 1-form, 1087
 Connection coefficients, 1133
 Conservation law, 963, 1065–1069
 characteristic, 1067
 classical field theory, 1069–1073
 equivalent, 1067
 trivial of the first kind, 1066
 trivial of the second kind, 1066
 Conserved current density, 1065
 Constant of the motion, 1066
 Constrained systems, 905
 Continuous index, 227–233
 Contour, 309
 simple closed, 309
 Contractable, 894
 Contraction, 788
 Contravariant degree, 784
 Contravariant tensor, 784
 Convergence
 infinite vector sum, 215–220
 Convex subset, 528
 Convolution theorem, 291
 Coordinate curve, 870
 Coordinate frame, 870
 Coordinate functions, 860
 Coordinate representation of L_{g^*} , 921
 Coordinate system
 left-handed, 800
 right-handed, 800
 Coordinate transformation
 orientation preserving, 898
 orientation reversing, 898
 Coset, 708
 Cosmological constant, 1165
 Cotangent bundle, 882
 Coulomb, 1058
 Coulomb potential, 466
 Countably infinite set, 11
 Covariant codifferential, 1108
 Covariant degree, 784
 Covariant derivative, 1117, 1123–1125,
 1133
 directional, 1119
 exterior, 1093
 Lie derivative, 1135
 Covariant differential, 1125
 Covariant tensor, 784
 Crystallography, 275
 Current density, 1065, 1110
 energy momentum, 1071
 formula for, 1111
 Curvature, 1125–1132
 abelian case, 1095
 and gravity, 1161
 as relative acceleration, 1160
 matrix structure group, 1096, 1097
 Curvature form, 1093
 principal fiber bundle, 1091–1097
 structure equation, 1093
 Curvature scalar, 1163
 Curvature tensor field, 1126
 Curvature transformation, 1126
 Curve
 coordinate, 870
 development of, 1137
 differentiable, 866
 Curvilinear coordinates, 1150
 Cyclic permutation, 717
 Cyclic subgroup, 707
- D**
 D'Alembert
 biography, 397
 D'Alembert, 1057
 Damping factor, 447
 Darboux, 799, 1015
 Darboux inequality, 313
 Darboux theorem, 902
 De Broglie, 907
 Decomposition
 algebra, 83–95
 Clebsch-Gordan, 753–756
 Dedekind, 11, 764, 792, 1130
 Degeneracy
 energy, 656
 lifting of, 748
 Degenerate eigenvectors, 402
 Degenerate kernel, 556–559
 Delta function, 229, 512, 624
 derivative of, 233
 expansion
 Fourier, 273
 general, 257
 Fourier transform, 279
 Green's function, 644, 685
 integral representation of, 281
 Legendre polynomials, 256
 limit of sequence, 229, 231
 potential, 653
 spherical harmonics, 692
 step function, 231, 232
 Sturm-Liouville eigenfunctions, 691
 variational problem, 1054
 Dense subset, 520
 Density function, 936
 Density of states, 584
 Derivation, 81, 82, 99, 106, 887, 891, 944,
 1124
 of an algebra, 80–83
 tangent vector, 868
 Derivation algebra, 82, 944
 Derivative
 complex function, 315–319
 covariant, 1117
 function of operator, 108
 functional, 1050–1053
 Hilbert spaces, 1047–1050
 of operators, 107–112
 total, 1027

- Derivative operator, 40
 - unboundedness of, 515
- Derived algebra, 66, 98
- Descartes, 791
- Determinant, 7, 55, 56, 118, 153–155, 158, 160–162, 173, 175, 201, 205, 557, 558, 567, 610, 641, 644, 661, 706, 719, 788, 800, 801, 806, 816–818, 839, 897, 898, 916, 924
 - analytic definition of, 205
 - connection with trace, 161
 - derivative of, 161
 - exponential of trace, 162
 - minor, 153
 - relation to trace, 160
- Determinant function, 54–56, 152, 158, 159, 162, 167, 799, 805, 815, 838, 848
 - dual, 158–160
 - normed, 815
- Determinant of a matrix, 151–160
- Development, 1137
- Diagonalization
 - simultaneous, 185–188
- Diffeomorphism, 865
- Differentiable curve, 866
 - tangent vector, 868
- Differentiable manifold, 859–866
 - dimension of a, 860
- Differentiable map, 864
 - coordinate expression of, 864
- Differential
 - of a constant map, 873
 - of a map, 872
 - real-valued maps, 874
- Differential equation
 - analytic, 460
 - analytic properties, 460–463
 - associated Legendre, 411
 - Bessel, 466
 - completely homogeneous problem, 612
 - Euler, 471
 - Fuchsian, 469–473
 - definition, 470
 - homogeneous, 418
 - hypergeometric, 466
 - definition, 473
 - inhomogeneous, 418
 - Legendre, 411
 - linear, 418
 - superposition principle, 423
 - multiparameter symmetry group, 1040–1043
 - Riemann, 471
 - second order linear
 - behavior at infinity, 469
 - second-order linear
 - Frobenius method, 440
 - regular, 422
 - symmetry group, 1014–1024
- Differential form, 888
 - closed, 894
 - exact, 894
 - Lorentz force law, 892
 - Maxwell's equations, 890
 - pullback of, 888
- Differential geometry, 1117–1140
- Differential one-form, 882
- Differential operator, 418, 970
 - adjoint, 433–436
 - linear, 605
- Diffusion equation, 643, 673
 - one-dimensional
 - parabolic, 642
 - time-dependent, 581, 582
- Dilation, 306
- Dilatation, 1159
- Dimension theorem, 42, 44, 45, 61, 99, 193, 518, 803, 810, 857, 876
- Dirac, 957
 - biography, 235
- Dirac delta function, 229, 512, 624
 - derivative of, 233
 - expansion
 - Fourier, 273
 - general, 257
 - Fourier transform, 279
 - Green's function, 644, 685
 - integral representation of, 281
 - Legendre polynomials, 256
 - limit of sequence, 229
 - spherical harmonics, 692
 - step function, 231
 - Sturm-Liouville eigenfunctions, 691
 - variational problem, 1054
- Dirac equation, 832–834, 997
- Dirac gamma matrices, 834
 - Majorana representation, 855, 1003
- Direct product
 - group, 712, 713
- Direct sum, 25–28, 75, 92, 119, 169, 201, 528, 558, 567, 712, 731, 797, 803, 810, 834–836, 840, 852, 947, 959, 999, 1001, 1087
 - algebra, 67
 - definition, 25
 - inner product, 32
- Directional covariant derivative, 1119
- Directional derivative, 884
- Dirichlet, 246, 791, 1130, 1144
 - biography, 666
- Dirichlet boundary condition, 642
- Dirichlet BVP, 642, 665–671
 - in two dimensions, 690
- Discrete Fourier transform, 286, 287
- Dispersion relation, 376–378
 - with one subtraction, 377
- Distribution, 234, 418, 686, 688

- Distribution (*cont.*)
 density, 234
 derivative of, 236
 Fourier transform, 287, 288
 Fourier transform of a , 288
 Green's function as, 606
 limit of functions, 235
- Divergence
 null Lagrangians, 1060, 1061
 of tensors, 1135
 total, 1060
- Divergence theorem, 648
- Division algebra, 69
 of a Clifford algebra, 999
- DOLDE
 hypergeometric
 Kummer's solutions, 477
- Domain, 5
- Dot product, 7, 29
- Dual
 basis, 51, 782
 of an operator, 51
 space, 48
- Dual determinant function, 158–160
- Dual space, 49
- E**
- Effective action, 713
- Eigenfunction expansion technique
 2D Laplacian, 689
- Eigenspace, 173, 180
 compact operator, 527
 compact resolvent operator, 565
 involution, 836
 normal operator, 179
 perturbation theory, 655
 Weyl operator, 955
- Eigenvalue, 172–175
 angular momentum, 401–405, 970
 Casimir operator, 969
 characteristic polynomial, 173
 circuit matrix, 462
 compact operators, 527
 definition, 172
 discrete, 630
 extrema of functions, 197
 Green's functions, 630, 688
 harmonic oscillator, 444
 hermitian operator, 178
 integral equation, 544
 invertible operator, 611
 involution, 836
 largest, 181
 orthogonal operator, 201
 perturbation theory, 656
 positive operator, 181
 projection operator, 174
 simple, 173
 smallest, 181
 Sturm-Liouville, 691
 Sturm-Liouville system, 568, 578
 unitary operator, 178
 upper-triangular matrix, 175
 Weyl operator, 959
- Eigenvector, 172–175, 178, 199
 angular momentum, 402, 406–413
 Casimir operator, 969
 compact normal operator, 532
 compact operators, 527
 definition, 172
 harmonic oscillator, 444
 hermitian operator, 433
 infinite dimensions, 518
 integral equation, 554
 normalized, 190
 perturbation theory, 656
 simultaneous, 185
 SOLDE, 463
 Sturm-Liouville system, 567
 Weyl operator, 959
- Einstein, 897, 956, 1070, 1131, 1145,
 1146, 1164, 1166
- Einstein tensor, 1163
- Einstein's equation, 1163–1166
 Schwarzschild solution, 1169
 spherically symmetric solutions,
 1167–1169
- Einstein's summation convention, 781
- Electromagnetic field tensor, 145, 826,
 889, 892, 893, 895
- Elementary column operation, 156
- Elementary row operation, 156
- Elliptic PDE, 641, 665–673
- Elsewhere, 941
- Empty set, 2
- Endomorphism, 39, 40, 42, 80, 81, 101,
 102, 125, 164, 705, 806, 807,
 1126
 involution, 72
- Energy function, 905
- Energy levels, 11
- Energy quantum number, 727
- Entire function, 301, 343
 Bessel functions, 572
 bounded, 317
 confluent HGF, 479
 inverse of gamma function, 379
 with simple zeros, 364
- Epimorphism
 algebra, 70
- Equivalence class, 3
 representative, 3
- Equivalence relation, 3, 4, 24
- Equivalent representations, 726
- Error function, 436
 as solution of a DE, 437
- Essential singularity, 342
- Essentially idempotent, 741, 772
- η -orthogonal matrices, 940
- Euclid, 220, 907

- Euclidean metric, 1149
- Euler, 301, 474, 482, 570, 1057, 1144
 - biography, 1055
- Euler angles, 146, 172, 934, 972
- Euler equation, 457
- Euler kernel, 494
- Euler operator, 1054
- Euler theorem, 973
- Euler transform, 493
- Euler-Lagrange equation, 1055, 1069
 - classical, 1053
 - field, 1053
- Euler-Mascheroni constant, 380
- Evaluation function, 1051
- Event, 941
- Evolution operator, 109, 678
- Exact form, 894
- Expectation value, 115
- Exponential function
 - complex, 302
- Exponential map, 925
- Exterior algebra, 794–801
- Exterior calculus, 888–897
- Exterior covariant derivative, 1093
- Exterior derivative, 889
 - covariant, 1093
- Exterior product, 794
 - inner product, 819, 820
- F**
- F*-related vector fields, 877
- Factor algebra, 77, 78, 92, 709
- Factor group, 710
- Factor map, 6
- Factor set, 4, 24
- Factor space, 24, 25, 77
- Factorial function, 378
 - Stirling approximation of, 386
- Faithful representation, 126, 726
- Fast Fourier transform, 287
- Fermi energy, 584
- Feynman diagram, 654
- Feynman propagator, 688
- Fiber, 1080
- Fiber bundle, 1079–1097
 - abelian case, 1095
 - principal, 1079–1086
- Fiber metric, 1143
- Field, 20
 - gauge, 1099–1105
 - magnetic, 3
 - particle, 1101
 - tensor
 - manifold, 876–888
 - vector
 - manifold, 877–882
- Fine-structure constant, 481, 655
- Finite-rank operator, 524
- First integral, 1066
- First variation, 1057
- Flat connection, 1095, 1096
- Flat manifold, 1153, 1154
- Flat map, 801, 902
- Flow, 881
- FODE
 - existence, 419–421
 - existence and uniqueness
 - local, 421
 - linear, 420
 - normal form, 420
 - Peano existence theorem, 420
 - uniqueness, 419–421
 - uniqueness theorem, 420
- FOLDE, 433
 - complex, 460–462
 - irregular singular point, 461
 - regular singular point, 461
 - removable singularity, 461
- Form
 - invariant
 - Lie group, 927, 928
 - pseudotensorial, 1092
 - tensorial, 1092
 - torsion, 1122
- Form factor, 284
- Formal adjoint, 612, 633, 648
- Four-potential, 895
- Four-vector, 808
 - energy momentum, 1071
- Fourier, 666, 703, 1056
 - biography, 267
- Fourier integral transforms, 278
- Fourier series, 265–276, 563
 - angular variable, 266
 - fundamental cell, 267
 - general variable, 268
 - group theory, 960
 - higher dimensions, 275, 276
 - main theorem, 272
 - Peter-Weyl, 960
 - sawtooth, 270
 - square wave, 269
 - to Fourier transform, 276–278
 - two-dimensional, 581
- Fourier transform, 276–288, 493
 - Coulomb potential
 - charge distribution, 283
 - point charge, 282
 - definition, 278
 - derivatives, 284, 285
 - discrete, 286, 287
 - distribution, 287, 288
 - Gaussian, 280
 - Green's functions, 680–688
 - higher dimensions, 281
 - quark model, 284
 - scattering experiments, 282
- Fourier-Bessel series, 587
- Fredholm, 220
- Fredholm, biography, 551

- Fredholm alternative, 551
- Fredholm equation, 543, 652
 - second kind
 - characteristic values, 544
- Fredholm integral equation, 549–559
- Free action, 713
- Friedmann, biography, 1166
- Friedmann metric, 1149
- Frobenius, 734, 957, 981
 - biography, 764
- Frobenius method, 439–444
- Frobenius Theorem, 93
- Fuchsian DE, 469–473
 - definition, 470
- Function, 5
 - analytic, 297–304
 - complex, 295, 296
 - derivatives as integrals, 315–319
 - integration, 309–315
 - determinant, 54
 - generalized, 233–237
 - inner product, 32
 - meromorphic, 363–365
 - multivalued, 365–371
 - of operators, 104–106
 - operator, 188–191
 - p-linear, 53
 - piecewise continuous, 266
 - square-integrable, 221–227
- Function algebra, 67
- Function of operator
 - derivative, 108
- Functional, 1054
 - linear, 48–53
- Functional derivative, 1050–1053
- Fundamental theorem of algebra, 318
- Fundamental vector field, 1086
- Future light cone, 941
- G**
- G-invariance, 1009
- G-invariant Lagrangian, 1106
- g-orthogonal, 808
- g-orthonormal, 813
- g-transpose, 806
- Galois, 154, 764, 946, 1015
 - biography, 702
- Gamma function, 250, 378–381
 - definition, 378
- Gamma matrices, 834
 - Majorana representation, 855
- Gauge
 - choice of, 1099
- Gauge field, 1099–1105
- Gauge invariance, 895
- Gauge Lagrangian, 1105
- Gauge Lagrangian density, 1109
- Gauge potential, 1099–1105
- Gauge theories, 1099–1114
- Gauge theory
 - local equation, 1112–1114
- Gauge transformation, 1102
- Gauss, 154, 251, 301, 482, 523, 533, 666, 791, 895, 1055, 1130, 1144
 - biography, 474
- Gay-Lussac, 581
- Gegenbauer function, 478
- Gegenbauer polynomials, 253
- General linear group, 705
 - representation, 963–966
- General relativity, 1163–1174
- Generalized Fourier coefficients, 220
- Generalized function, 233–237, 418, 606, 688
- Generalized Green's identity, 613, 626, 648
- Generating function, 257
- Generator
 - Clifford algebra, 997, 1000
 - conformal group, 1036, 1159
 - coordinate transformation, 934
 - cyclic group, 710
 - group, 933, 1113
 - group action, 962
 - infinitesimal, 929, 932, 970, 976, 1010–1013, 1023, 1030, 1037, 1040, 1041, 1062, 1064, 1068, 1069
 - Lorentz, 1073
 - of an algebra, 70
 - rotation, 106, 750, 933, 998, 1157
 - translation, 112, 948
- Geodesic, 1137–1140
 - relative acceleration, 1160
- Geodesic deviation, 1159–1163
 - equation of, 1161
- Geodesic equation, 1138
 - massive particles, 1170, 1171
 - massless particles, 1170, 1172
- Geometric multiplicity, 173
- Geometry
 - Riemannian, 1143–1174
 - symplectic, 51, 901–909
- Gibbs, 523, 907
- Gibbs phenomenon, 273–275
- $GL(n, \mathbb{R})$ as a Lie group, 916
- $GL(\mathcal{V})$
 - as a Lie group, 915
 - representation of, 963
- Gödel, 897
- Gordan, 1070
 - biography, 755
- Gradient
 - for Hilbert spaces, 1050
- Gradient operator, 1133
- Gram, 34
- Gram-Schmidt process, 33–35, 164, 210, 241, 532
- Graph, 5
- Grassmann, 799, 1070

- Grassmann product, 794
- Gravitational red-shift, 1173
- Gravity
 - and curvature, 1161
 - Newtonian, 1161–1163
- Green, biography, 613
- Green's function, 358
 - adjoint, 618
 - advanced, 686
 - as a distribution, 606
 - Dirichlet BC
 - circle, 670
 - eigenfunction expansion, 630–632
 - for d/dx , 606
 - for d^2/dx^2 , 607
 - formal considerations, 610–617
 - Helmholtz operator
 - in 2D, 694
 - in one dimension, 605
 - indefinite, 606–610
 - multidimensional
 - delta function, 643–648
 - diffusion operator, 684, 685
 - Dirichlet BVP, 665–671
 - eigenfunction expansion, 688–693
 - Fourier transform, 680–688
 - fundamental solution, 649–651
 - general properties, 648, 649
 - Helmholtz operator, 682–684
 - integral equations, 652–655
 - Laplacian, 647, 648, 681, 682
 - Neumann BVP, 671–673
 - perturbation theory, 655–661
 - wave equation, 685–688
 - Neumann BVP, 673
 - exterior, 673
 - interior, 673
 - physical interpretation, 629
 - properties, 619
 - regular part of, 651
 - resolvent, 630
 - retarded, 686
 - second order DO, 614–616
 - self-adjoint SOLDOS, 616, 617
 - singular part of, 651
 - SOLDO, 617–629
 - construction, 621–626
 - inhomogeneous BCs, 626–629
 - properties, 619–621
 - uniqueness, 621–626
 - symmetry, 619
- Green's identity, 619, 648, 675, 679
 - generalized, 648
- Group, 8, 702–705
 - 1st isomorphism theorem, 710
 - abelian, 704
 - affine, 948
 - algebra
 - symmetric group, 771
 - automorphism, 705
 - center of, 708
 - commutative, 704
 - commutator of, 707
 - direct product, 712, 713
 - external, 712
 - internal, 712
 - external direct product, 712
 - finite
 - Lagrange's theorem, 721
 - homomorphism, 705
 - kernel of, 708
 - internal direct product, 712
 - isomorphism, 705
 - left action, 713
 - Lie, 915–936
 - multiplication, 702
 - multiplication table, 705
 - of affine motions, 917
 - order of, 703
 - orthogonal, 706
 - realization, 715
 - representation, 725–732
 - character table, 743
 - criterion for irreducibility, 738
 - crystallography, 727
 - irreducible, projection operator, 749
 - irreducible basis function, 746–750
 - matrix, 727
 - particles and fields, 751
 - quantum state parity, 727
 - tensor product, 750–758
 - right action, 713
 - rigid rotations, 706
 - simply reducible, 753
 - special orthogonal, 706
 - special unitary, 706
 - subset
 - left invariant, 713
 - right invariant, 713
 - word on, 720
 - symmetric, 715–720
 - symmetry of Hamiltonian, 725
 - symplectic, 707, 803
 - unitary, 706
- Group action, 713–715
 - effective, 713, 918
 - free, 713, 918
 - infinitesimal, 928–935
 - infinitesimal generator, 929
 - Lie groups, 917–920
 - orbit, 713
 - stabilizer, 713
 - transitive, 713, 918
- Group algebra, 740
 - representations, 740–743
- Guided waves
 - TE, 585
 - TEM, 585
 - TM, 585

- H**
- Haar measure, 935
 - Halley, 481
 - Hamilton, 246, 545, 1070
 - biography, 906
 - Hamiltonian
 - group of symmetry of, 725
 - Hamiltonian mechanics, 801, 904
 - Hamiltonian system, 905
 - Hamiltonian vector field, 905
 - energy function, 905
 - Hankel function, 484
 - first kind
 - asymptotic expansion of, 386
 - second kind, 391
 - Hankel transform, 494
 - Harmonic functions, 304
 - Harmonic oscillator, 443, 444–446
 - critically damped, 447
 - ground state, 444
 - Hamiltonian, 444
 - overdamped, 447
 - underdamped, 447
 - Heat equation, 395, 643, 673
 - symmetry group, 1030–1034
 - Heat transfer
 - time-dependent, 581, 582
 - Heat-conducting plate, 597
 - Hegel, 791
 - Heisenberg, 115, 236
 - Helicity, 982
 - Helmholtz, 246, 639, 957
 - Helmholtz equation, 593
 - Hermite, 251, 896
 - biography, 115
 - Hermite polynomials, 245, 248, 249, 442, 573
 - Hermitian, 31, 48, 116, 117, 120, 144, 147, 172, 177, 178, 181, 186, 189, 205, 402, 525, 533, 555, 558, 564, 613, 924, 945, 955, 968, 982
 - Hermitian conjugate, 113–116, 144, 146, 162, 171, 202, 404, 513, 661
 - Hermitian inner product, 31
 - Hermitian kernel, 552–556
 - Hermitian operator, 114–119
 - Hilbert, 11, 34, 268, 523, 755, 897, 956, 1070, 1164
 - biography, 220
 - Hilbert space, 215–227, 435
 - basis of, 219
 - bounded operators in, 513
 - compact hermitian operator in, 530
 - compact normal operator in, 532
 - compact operator in, 524
 - compact resolvent, 564
 - convex subset, 528
 - countable basis, 228
 - definition, 218
 - derivative, 1047–1050
 - differential of functions, 1049
 - directional derivative, 1050
 - functions on, 1052
 - derivative of, 1049
 - invertible operator in, 611
 - operator norm, 513
 - perturbation theory, 658
 - representation theory, 726, 953
 - square-integrable functions, 222
 - Hilbert transform, 377
 - Hilbert-Schmidt kernel, 525, 549
 - Hilbert-Schmidt operator, 525, 955
 - Hilbert-Schmidt theorem, 552
 - HNOLDE, 446, 448
 - characteristic polynomial, 446
 - Hodge star operator, 820–823, 893
 - Hölder, 523
 - Homographic transformations, 307
 - Homomorphism
 - algebra, 70, 71, 77, 82, 98, 125
 - Clifford algebra, 837
 - Clifford group, 991
 - group, 705, 710, 726, 731, 732, 987, 992
 - Lie algebra, 922, 944, 953, 1101
 - Lie group, 915, 922, 928, 953, 967
 - PFB, 1081
 - symmetric, 705
 - trivial, 705
 - Horizontal lift, 1089
 - HORIZONTAL vector field, 1087
 - HSOLDE
 - basis of solutions, 425
 - comparison theorem, 431
 - exact, 433
 - integrating factor, 433
 - second solution, 426–428
 - separation theorem, 430
 - Hydrogen, 11
 - Hydrogen-like atoms, 480–482
 - Hyperbolic PDE, 641, 678–680
 - Hypergeometric DE, 466
 - Hypergeometric function, 473–478
 - confluent, 478–485
 - integral representation of, 497, 498
 - contiguous functions, 476
 - Euler formula, 496
 - integral representation of, 494–498
 - Hypergeometric series, 473
 - Hypersurface, 635
- I**
- Ideal, 73–78
 - Idempotent, 83, 86–89, 119–125, 175, 741, 844, 852, 999, 1002
 - essentially, 741, 772
 - primitive, 88, 94, 999, 1001, 1002
 - principal, 87–89
 - rank, 94

- Identity
 - additive, 20
 - multiplicative, 20
- Identity map, 5
- Identity operator, 101
- Identity representation, 726
- Ignorable coordinate, 645
- Image
 - map, 5
- Image of a subset, 5
- Implicit function theorem, 419
- Index
 - continuous, 227–233
- Indicial equation, 465
 - SOLDE, 465
- Indicial polynomial, 465
- Induced representations, 978
- Induction principle, 12
- Inductive definition, 14
- Inequality
 - Bessel, 219
 - Cauchy, 336
 - Darboux, 313
 - Parseval, 219
 - Schwarz, 35
 - triangle, 36
- Infinitesimal action
 - adjoint, 929
- Infinitesimal generator, 929, 932
- Initial conditions, 418
- Initial value problem, 611, 635
- Injective map, 5
- Inner automorphism, 926
- Inner product, 29–38, 804–820
 - bra and ket notation, 31
 - complex bilinear, 46
 - definition of, 30
 - direct sum, 32
 - Euclidean, 31
 - exterior product, 819, 820
 - G-orthogonal, 1107
 - hermitian, 31
 - indefinite
 - orthonormal basis, 812–819
 - subspaces, 809–812
 - isotropic vector, 808
 - norm and, 37
 - null vector, 808
 - positive definite, 30
 - pseudo-Euclidean, 31
 - sesquilinear, 31
 - signature, 813
- Inner product space, 31
- INOLDE
 - particular solution, 448
- Integral
 - principal value, 354–358
- Integral curve, 879
- Integral equation, 543–548
 - characteristic value, 544
 - first kind, 543
 - Fredholm, 549–559
 - Green's functions, 652–655
 - kernel of, 543
 - second kind, 543
 - Volterra, 543
 - Volterra, of second kind
 - solution, 545
- Integral operator, 512
- Integral transform, 493
 - Bessel function, 494
- Integration
 - complex functions, 309–315
 - Lie group, 935, 936
 - manifolds, 897–901
- Integration operator, 40
- Interior product, 829, 891
- Intersection, 2
- Intrinsic spin, 1073
- Invariant, 1010
 - map, 1010
 - operator
 - matrix representation, 171
 - subspace, 169–172
 - definition, 170
- Invariant subspace, 728, 729
- Inverse
 - image, 5
 - of a map, 6
 - of a matrix, 155–158
- Inverse mapping theorem, 873
- Inversion, 154, 306, 1159
- Involution, 72, 82, 836, 837, 839, 843, 848, 989, 990
- Irreducible basis function, 746–750
- Irreducible representation, 729
 - i-th row
 - functions, 747
 - norm of functions, 747
- Irreducible set of operators, 757
- Irreducible tensor operators, 756–758
- Irreducible tensorial set, 757
- Isolated singularity, 342–344
- Isolated zero, 330
- ISOLDE
 - general solution, 428–430
- Isometric map, 39, 1155
- Isometry, 40, 42, 43, 125, 205, 539, 806, 807, 811, 826, 992, 1143, 1155–1159, 1168
 - time translation, 1167
- Isomorphism, 43–45, 52, 68, 74, 78, 127, 139, 140, 158, 222, 228, 661, 704, 719, 721, 726, 789, 796, 801, 838, 845, 847, 851, 871, 872, 884, 905, 921, 922, 926, 930, 945, 972, 998, 1085–1087, 1089, 1103, 1118, 1128, 1143
- algebra, 70
- Clifford algebras, 842, 843

- Isomorphism (*cont.*)
 group, 705
 Lie algebra, 922
 Lie group, 915
 linear, 43–45
 natural, 785
 PFB, 1081
 Isotropic vector, 808
- J**
 Jacobi, 251, 475, 545, 666, 713, 753, 755, 791, 907, 1144
 biography, 246
 Jacobi function
 first kind, 477
 second kind, 478
 Jacobi identity, 879, 887, 927
 Jacobi polynomials, 245, 250, 252, 478
 special cases, 245
 Jacobian matrix, 873
 Jordan arc, 309
 Jordan canonical form, 539
 Jordan's lemma, 345
- K**
 Kant, 791
 Kelvin, 613
 Kelvin equation, 589
 Kelvin function, 589
 Kepler problem, 1074
 Kernel, 41, 42, 51, 130, 158, 173, 192, 198, 498, 529, 546, 558, 560, 635, 678, 708, 826, 937, 944, 995, 999
 degenerate, 556–559
 hermitian, 552–556
 Hilbert-Schmidt, 525, 544, 555
 integral operator, 512
 integral transforms, 493
 separable, 556
 Ket, 20
 Killing, 799, 1015
 biography, 946
 Killing equation, 1156
 Killing form, 945, 948
 of $\mathfrak{gl}(n, \mathbb{R})$, 947
 Killing parameter, 1167
 Killing vector field, 1155–1159, 1167, 1170, 1173
 conformal, 1158
 Kirchhoff, 639
 Klein, 799, 896, 956, 1015, 1070, 1131, 1164
 Klein-Gordon equation, 396
 Korteweg-de Vries equation, 1044
 Kovalevskaya, 523
 biography, 639
 Kramers-Kronig relation, 378
 Kronecker, 11, 154
 biography, 791
 Kronecker delta, 32, 50, 161, 782, 939
 Kronecker product, 751
 Kummer, 36, 755, 791, 946, 1130
- L**
 Lagrange, 154, 246, 251, 267, 474, 482, 581, 755
 biography, 1057
 Lagrange identity, 435, 494, 570, 578, 613, 805
 Lagrange multiplier, 1064
 Lagrange's equation, 1111
 Lagrangian, 904, 1054
 G-invariant, 1106
 gauge, 1109
 gauge-invariant, 1105–1107
 construction, 1107–1111
 null, 1060, 1061
 Lagrangian density, 1105
 Laguerre polynomials, 245, 249, 250
 Laplace, 34, 267, 666, 906, 1056, 1058, 1164
 biography, 581
 Laplace transform, 493
 Laplace's equation, 395
 Cartesian coordinates, 579
 cylindrical coordinates, 586
 elliptic, 642
 Laplacian
 Green's function for, 647
 separated
 angle radial, 399
 spherical coordinates
 separation of angular part, 398–401
 Laurent, biography, 340
 Laurent series, 321–330, 657
 construction, 322
 uniqueness, 325
 Lavoisier, 153, 1058
 Least square fit, 225–227
 Lebesgue, 221
 Left annihilator, 73
 Left coset, 708
 Left ideal, 73, 74, 84, 740, 773, 1000, 1002
 minimal, 74, 76, 79, 94, 128, 129, 772, 999, 1001, 1003
 Left translation
 as action, 929
 Left-invariant 1-form, 921
 Left-invariant vector field, 920
 Legendre, 246, 267, 545, 666, 1144
 biography, 251
 Legendre equation, 436, 441, 572
 Legendre function, 478
 Legendre polynomial, 225, 250–252, 256, 408, 411, 428, 555
 and Laplacian, 256
 asymptotic formula, 576

- delta function, 256
 - Legendre transformation, 904
 - Leibniz, 154, 791
 - Leibniz formula, 81
 - Leibniz rule, 16
 - Length
 - vector, 36–38
 - Levi-Civita, 1131
 - biography, 1146
 - Levi-Civita connection, 1145
 - Levi-Civita tensor, 799, 976
 - Lie, 764, 799, 896, 946
 - biography, 1014
 - Lie algebra, 915–936
 - abelian, 937
 - adjoint map, 926
 - Cartan metric tensor, 945
 - Cartan theorem, 948
 - center, 937
 - commutative, 937
 - compact, 945
 - decomposition, 947
 - derivation, 944
 - ideal, 937
 - Killing form of, 945
 - of a Lie group, 920–927
 - of $SL(V)$, 924
 - of unitary group, 924
 - of vector fields, 879
 - representation, 966–983
 - definition, 953
 - semisimple, 948
 - simple, 948
 - structure constants, 937
 - theory, 936–948
 - Lie bracket, 879
 - Lie derivative, 885
 - covariant derivative, 1135
 - of a 1-form, 886
 - of p -forms, 890
 - of vectors, 886
 - Lie group, 405, 915–936
 - canonical 1-form on, 928
 - compact
 - characters, 960
 - matrix representation, 959
 - representation, 953–963
 - unitary representation, 954
 - Weyl operator, 955
 - group action, 917–920
 - homomorphism, 915
 - infinitesimal action, 928–935
 - integration, 935, 936
 - density function, 936
 - invariant forms, 927, 928
 - left translation, 920
 - local, 917
 - representation, 953
 - Lie multiplication, 937
 - Lie subalgebra, 937
 - Lie's first theorem, 932
 - Lie's second theorem, 927
 - Lie's third theorem, 927
 - Light cone, 941
 - Linear combination, 21
 - Linear connection, 1120–1140
 - definition, 1121
 - Linear frame, 1083
 - Linear functional, 48–52, 53, 53, 61, 233, 234, 287, 515, 617, 783, 787, 796, 809, 829, 883
 - Linear independence, 21
 - Linear isomorphism, 43–45, 49
 - Linear map, 38–45, 51, 70, 78, 95, 116, 563, 789, 801, 814, 837, 838, 840, 856, 1048, 1049, 1073
 - invertible, 43
 - Linear operator, 39–41, 47, 55, 56, 66, 113, 115, 116, 119, 139, 140, 151, 170, 171, 174, 422, 513, 515, 517, 522, 529, 531, 564, 785, 793, 799, 810, 944
 - determinant, 55, 56
 - null space of a, 41
 - Linear PDE, 636
 - Linear transformation, 53
 - bounded, 514
 - definition, 39
 - pullback of a, 51
 - Liouville, 568, 703
 - biography, 570
 - Liouville substitution, 569, 573, 576, 577
 - Liouville's theorem, 908
 - Lipschitz condition, 420
 - Little algebra, 978
 - Little group, 714, 978–981
 - Local diffeomorphism, 865
 - Local group of transformations, 917
 - Local Lie group, 917
 - Local operator, 512
 - Local trivialization, 1080
 - Logarithmic function, 365
 - Lorentz, 897
 - Lorentz algebra, 972
 - Lorentz force law, 892
 - Lorentz group, 707, 940
 - Lorentz metric, 1149
 - Lorentz transformation, 940
 - orthochronous, 941
 - proper orthochronous, 941
 - Lowering indices, 805
 - Lowering operator, 403
- M**
- Maclaurin series, 321
 - Magnetic field, 3
 - Manifold, 859–866
 - atlas, 860
 - chart, 860
 - coordinate functions, 860

- Manifold (*cont.*)
- differentiable, 859–866
 - differential of a map, 872–876
 - flat, 1153
 - integration, 897–901
 - orientable, 898
 - product, 863
 - pseudo-Riemannian, 1144
 - Riemannian, 1144
 - semi-Riemannian, 1144
 - subset
 - contractable to a point, 894
 - symplectic, 902
 - tangent vectors, 866–872
 - tensor fields, 876–888
 - vector fields, 877–882
 - with boundary, 899
- Map, 4–8
- bijective, 6
 - codomain, 5
 - conformal, 304–309
 - differentiable, 864
 - differential
 - Jacobian matrix of, 873
 - domain, 5
 - equality of, 5
 - functions and, 5
 - graph of a, 5
 - identity, 5
 - image of a subset, 5
 - injective, 5
 - inverse of a, 6
 - isometric, 39
 - linear, 38–45
 - invertible, 43
 - manifold, 872–876
 - multilinear, 53–57, 782–789
 - skew-symmetric, 53
 - one-to-one, 5
 - onto, 6
 - p-linear, 53
 - range of a, 5
 - surjective, 5
 - target space, 5
- Maschke's Theorem, 759
- Mathematical induction, 12–14
- Matrix, 137–142
- antisymmetric, 144
 - basis transformation, 149
 - block diagonal, 171, 200
 - circuit, 462, 463
 - complex conjugate of, 144
 - determinant of, 151–160
 - diagonal, 144
 - diagonalizable, 162
 - hermitian, 144
 - hermitian conjugate of, 144
 - inverse of, 155–158
 - irreducible, 171
 - operations on a, 142–146
 - orthogonal, 144
 - rank of, 158
 - reducible, 171
 - representation
 - orthonormal basis, 146–148
 - row-echelon, 156
 - strictly upper triangular, 66
 - symmetric, 144
 - symplectic, 804
 - transpose of, 142
 - triangular, 156
 - unitary, 144
 - upper triangular, 66
 - upper-triangular, 175, 176
- Matrix algebra, 66, 78–80
- Matrix of the classical adjoint, 152–155
- Maurer-Cartan equation, 928, 1095
- Maximally symmetric spaces, 1157
- Maxwell's equations, 894
- Mellin transform, 493
- Mendelssohn, 666, 792
- Meromorphic functions, 363–365
- Method of images, 668
- sphere, 669
- Method of steepest descent, 383, 577
- Metric, 37
- Friedmann, 1149
 - Schwarzschild, 1149
- Metric connection, 1143–1155
- Metric space, 8–10
- complete, 10
 - convergence, 9
 - definition, 8
- Minimal ideal, 963
- Minimal left ideal, 74, 76, 79, 94, 128, 129, 772, 999, 1001, 1003
- Minkowski, 1164
- Minkowski metric, 1149
- Mittag-Leffler, 523, 640
- Mittag-Leffler expansion, 364
- Modified Bessel function, 484
- first kind
 - asymptotic expansion of, 391
 - second kind
 - asymptotic expansion of, 392
- Moment of inertia, 145, 195
- matrix, 145
- Momentum operator, 398
- Monge, 153, 267
- Monomorphism
- algebra, 70
- Morera's theorem, 319
- Multidimensional diffusion operator
- Green's function, 684, 685
- Multidimensional Helmholtz operator
- Green's function, 682–684
- Multidimensional Laplacian
- Green's function, 681, 682
- Multidimensional wave equation

- Green's function, 685–688
- Multilinear, 152, 783, 789, 883, 1092, 1124
- Multilinear map, 53–57, 782–789
 - tensor-valued, 787
- Multiplicative identity, 20
- Multivalued functions, 365–371

- N**
- n -equivalent functions, 1018
- n -sphere, 860, 865
- n -th jet space, 1018
- n -tuple, 3
 - complex, 21
 - real, 21
- Napoleon, 267, 581
- Natural isomorphism, 785, 820
- Natural numbers, 2, 9
- Natural pairing, 783
- Neighborhood
 - open round, 519
- Neumann, 246, 753
 - biography, 671
- Neumann BC, 643
- Neumann BVP, 643, 671–673
- Neumann function, 483
- Neumann series, 548, 653, 654
- Newton, 397, 474, 581, 896, 906, 1056
- Newtonian gravity, 1161–1163
- Nilpotent, 83–85, 88, 91, 539
- Noether, 755
 - biography, 1069
- Noether's theorem, 1065–1069
 - classical field theory, 1069–1073
- NOLDE
 - circuit matrix, 462
 - constant coefficients, 446–449
 - existence and uniqueness, 611
 - integrating factor, 632
 - simple branch point, 463
- Non-local potential, 683
- Nondegenerate subspace, 810
- Norm, 215, 217, 291, 513–515, 529, 544, 812
 - of a vector, 36
 - operator, 514
 - product of operators, 516
- Normal coordinates, 1138–1140
- Normal operator, 177
- Normal subgroup, 709
- Normal vectors, 32
- Normed determinant function, 815
- Normed linear space, 36
- Null divergence, 1066
- Null Lagrangian, 1060, 1061
- Null space, 41, 551, 554
- Null vector, 808, 941
- Nullity, 41
- Number
 - complex, 2
 - integer, 2
 - natural, 2, 9
 - rational, 4, 9, 10
 - real, 2

- O**
- ODE, 417–419
 - first order
 - symmetry group, 1037–1039
 - higher order
 - symmetry group, 1039, 1040
- Ohm, 666
- Olbers, 482
- One-form, 882
- One-parameter group, 881
- One-to-one correspondence, 6
- Open ball, 519
- Open subset, 520
- Operation
 - binary, 7
- Operations on matrices, 142–146
- Operator, 39
 - adjoint, 113
 - existence of, 517
 - adjoint of, 46
 - angular momentum, 398
 - eigenvalues, 401–405
 - annihilation, 444
 - anti-hermitian, 115
 - bounded, 513–517
 - Casimir, 969–971
 - closed, 564
 - bounded, 564
 - compact, 523–526
 - spectral theorem, 527–534
 - compact Hermitian
 - spectral theorem, 530
 - compact normal
 - spectral theorem, 532
 - compact resolvent, 564
 - conjugation, 113, 114
 - creation, 444
 - derivative, 40, 107–112
 - determinant, 55, 56
 - diagonalizable, 174
 - differential, 511, 512
 - domain of, 563
 - evolution, 109
 - expectation value of, 115
 - extension of, 564
 - finite rank, 524
 - formally self-adjoint, 649
 - functions of, 104–106, 188–191
 - hermitian, 114–119, 564
 - eigenvalue, 178
 - hermitian conjugate of, 113
 - Hilbert-Schmidt, 525, 551, 567
 - Hodge star, 820–823
 - idempotent, 119–125
 - integral, 511, 512

- Operator (*cont.*)
- integration, 40
 - inverse, 101
 - involution, 72
 - kernel of an, 41
 - local, 512
 - negative powers of, 103
 - norm of, 514
 - normal, 177
 - diagonalizable, 181
 - eigenspace of, 179
 - null space of an, 41
 - polar decomposition, 205–208
 - polarization identity, 41
 - polynomials, 102–104
 - positive, 117
 - positive definite, 117
 - projection, 120–125
 - orthogonal, 121
 - pullback of an, 51
 - raising and lowering, 403
 - regular point, 517
 - representation of, 138
 - resolvent of, 534
 - right-shift, 513
 - scalar, 757
 - self-adjoint, 46, 115, 564
 - skew, 46
 - spectrum, 517, 518
 - spectrum of, 173
 - square root, 189
 - square root of, 189
 - strictly positive, 117
 - Sturm-Liouville, 564, 566
 - symmetric, 193
 - tensor
 - irreducible, 756–758
 - trace of, 161
 - unbounded
 - compact resolvent, 563–569
 - unitary, 114–119, 189
 - eigenvalue, 178
- Operator algebra, 101–107
- Lie algebra $\mathfrak{o}(p, n - p)$, 940–943
- Opposite algebra, 66
- Optical theorem, 378
- Orbit, 728, 918
- Orbital angular momentum, 1073
- Ordered pairs, 2
- Orientable manifolds, 898
- Orientation, 800, 801, 898
 - positive, 801
- Oriented basis, 800
- Orthogonal, 40
- Orthogonal basis
 - Riemannian geometry, 1148–1155
- Orthogonal complement, 169, 528–530, 551, 729, 747, 802, 812, 841
- Orthogonal group, 706, 925
 - Lie algebra of, 925
- Orthogonal polynomial, 222–225, 579
 - classical, 241, 241–243
 - classification, 245
 - differential equation, 243
 - generating functions, 257
 - recurrence relations, 245
 - expansion in terms of, 254–257
 - least square fit, 225
- Orthogonal transformation, 154
- Orthogonal vectors, 32
- Orthogonality, 32, 33
 - group representation, 732–737
- Orthonormal basis, 32
 - indefinite inner product, 812–819
 - matrix representation, 146–148
- P**
- p -form, 796
 - vector-valued, 800
- Pairing
 - natural, 783
- Parabolic PDE, 641, 673–678
- Parallel displacement, 1090
- Parallel section, 1091, 1119
- Parallelism, 1089–1091
- Parallelogram law, 37
- Parameter
 - affine, 1138
- Parity, 718
 - Hermite polynomials, 262
 - Legendre polynomials, 262
- Parseval equality, 220
- Parseval inequality, 219, 958
- Parseval's relation, 291
- Particle field, 1101
- Particle in a box, 582–584
- Particle in a cylindrical can, 601
- Particle in a hard sphere, 593
- Partition, 4, 720
- Past light cone, 941
- Pauli spin matrices, 146, 938, 944
 - Clifford algebra representations, 997–1001
- PDE, 635–643
 - Cauchy data, 636
 - Cauchy problem, 636
 - characteristic hypersurface, 636–640
 - characteristic system of, 1012
 - elliptic, 665–673
 - mixed BCs, 673
 - homogeneous, 397
 - hyperbolic, 678–680
 - inhomogeneous, 397
 - order of, 636
 - parabolic, 673–678
 - principal part, 636
 - second order, 640–643
 - second-order
 - elliptic, 641

- PDE (*cont.*)
 hyperbolic, 641
 parabolic, 641
 ultrahyperbolic, 641
- PDEs of mathematical physics, 395–398
- Peano, 897
- Peirce decomposition, 87, 89, 90, 100
- Periodic BC, 571
- Permutation, 53
 cyclic, 717
 even, 719
 odd, 719
 parity of, 718
- Permutation group, 715
- Permutation tensor, 816
- Perturbation theory, 655, 748
 degenerate, 660, 661
 first-order, 660
 nondegenerate, 659, 660
 second-order, 660
- Peter-Weyl theorem, 960
 Fourier series, 960
- PFB
 local section, 1083
- Phase space, 801
- Photon capture
 cross section, 1173
- Piecewise continuous, 266
- $\text{Pin}(\mu, \nu)$, 995
- Planck, 523, 1164
- Poincaré, 115, 533, 552, 672, 799, 1164
 biography, 895
- Poincaré algebra, 943, 948
 representation, 975–983
- Poincaré group, 707, 917, 943, 979
- Poincaré lemma, 894
 converse of, 895
- Poisson, 246, 568, 581, 666, 703
- Poisson bracket, 908
- Poisson integral formula, 671
- Poisson's equation, 395, 648, 1162
- Polar decomposition, 205–208
- Polarization identity, 41, 812
- Pole, 342
- Polynomial, 20
 inner product, 32
 operators, 102–104
 orthogonal, 222–225
- Polynomial algebra, 95–97
- Positive definite operator, 117
- Positive operator, 117
- Positive orientation, 801
- Potential
 gauge, 1099–1105
 non-local, 683
 separable, 683
- Power series, 319
 differentiation of, 320
 integration of, 320
- SOLDE solutions, 436–446
 uniform convergence, 320
- Lie algebra $\mathfrak{p}(p, n - p)$, 940–943
- Preimage, 5
- Primitive idempotent, 88, 94, 999, 1001, 1002
- Principal fiber bundle
 curvature form, 1091
- Principal fiber bundle, 1079–1086
 associated bundle, 1084–1086
 base space, 1080
 connection, 1086–1091
 matrix structure group, 1096, 1097
 curvature
 matrix structure group, 1096, 1097
 curvature form, 1097
 curve
 horizontal lift, 1089
 fundamental vector field, 1086
 global section, 1083
 lift of curve, 1089
 parallelism, 1089–1091
 reducible, 1082
 structure group, 1080
 matrix, 1096, 1097
 trivial, 1080
 vector field
 horizontal lift, 1089
- Principal idempotent, 87–89
- Principal part
 PDE, 636
- Principal value, 354–358, 685
- Product
 Cartesian, 2, 7
 dot, 7
 inner, 29–38
 tensor, 28, 29
- Product manifold, 863
- Projectable symmetry, 1017
- Projection, 6
- Projection operator, 120–125, 169, 174, 180, 527, 529, 532, 536, 552, 655–657, 688, 748, 809
 completeness relation, 123
 orthogonal, 121
- Projective group
 density function, 936
 one-dimensional, 920
- Projective space, 4
- Prolongation, 1017–1024
 functions, 1017–1021
 groups, 1021, 1022
 of a function, 1019
 vector fields, 1022–1024
- Propagator, 654, 678
 Feynman, 688
- Proper subset, 2
- Prüfer substitution, 574
- Pseudo-Riemannian manifold, 1144
- Pseudotensorial form, 1092

- Puiseux, biography, 365
 Pullback, 789, 883, 888, 898, 1094, 1112
 linear transformation, 51
 of p -forms, 796
- Q**
- Quadratic form, 843
 Quantization
 harmonic oscillator
 algebraic, 445
 analytic, 443
 hydrogen atom, 481
 Quantum electrodynamics, 654
 Quantum harmonic oscillator, 444–446
 Quantum mechanics
 angular momentum, 405
 Quantum particle in a box, 582–584
 Quantum state
 even, odd, 727
 Quark, 753, 754, 980
 Quaternion, 69, 98, 831, 846, 847, 856,
 907, 989, 990, 993, 996, 1070
 absolute value, 70
 conjugate, 69
 pure part, 69
 real part, 69
 Quotient group, 710
 Quotient map, 6
 Quotient set, 4, 24
 Quotient space, 24, 25
- R**
- r -cycle, 716
 Radical, 84–88
 Radon-Hurwitz number, 1002
 Raising indices, 805
 Raising operator, 403
 Range of a map, 5
 Rank of a matrix, 158
 Rational function, 343
 integration of, 345–348
 Rational numbers, 4, 9, 10
 dense subset of reals, 520
 Rational trig function
 integration of, 348–350
 Real coordinate space, 21
 Real normal operator
 spectral decomposition, 198–205
 Real vector space, 20
 Realization, 715
 Reciprocal lattice vectors, 276
 Recurrence relations, 222
 Redshift, 1173
 Reduced matrix elements, 758
 Reducible bundle, 1082
 Reducible representation, 729
 Reflection, 808
 Reflection operator, 121
 Reflection principle, 374–376
 Reflexivity, 3
- Regular point, 301, 460
 operator, 517, 551
 Regular representation, 128, 739
 Regular singular point
 SOLDE, 464
 Relation, 3, 24
 equivalence, 3, 4
 Relative acceleration, 1160
 Relativistic electromagnetism, 889
 Relativity
 general, 1163–1174
 Removable singularity
 FOLDE, 461
 Representation
 abelian group, 733
 action on Hilbert space, 726
 adjoint, 732, 755, 1092, 1102
 algebra, 125–131
 angular momentum, 402
 carrier space, 726
 character of, 736
 classical adjoint, 152
 Clifford algebras, 987–1006
 compact Lie group, 945, 953–963
 complex conjugate, 732
 dimension of, 726
 direct sum, 128, 731
 equivalent, 127, 726
 faithful, 126, 726
 general linear group, 715, 963–966
 Representation of
 $\mathfrak{gl}(n, \mathbb{R})$, 968
 Representation
 group, 725–732
 adjoint, 755
 analysis, 737–739
 antisymmetric, 745, 771
 identity, 754, 758, 771
 irreducible, 734, 737
 irreducible basis function, 746–750
 irreducible in regular, 739
 orthogonality, 732–737
 tensor product, 750–758
 trivial, 769
 group algebra, 740–743
 hermitian operator, 182
 identity, 726, 1092
 irreducible, 127, 729
 compact Lie group, 957
 finite group, 730
 general linear group, 964
 Lie group, 1072
 semi-simple algebra, 130
 Kronecker product, 751
 Lie algebra, 948, 966–983
 Casimir operator, 969
 Lie group, 937, 953
 unitary, 953
 matrix
 orthonormal basis, 146–148

- Representation (*cont.*)
 - operator, 161, 169, 199, 923
 - operators, 138
 - orthogonal operator, 201
 - quantum mechanics, 734, 748
 - quaternions, 126
 - reducible, 729
 - regular, 128, 739
 - semi-simple algebra, 130
 - simple algebra, 129
 - Representation of
 - $\mathfrak{sl}(n, \mathbb{C})$, 968
 - Representation
 - $\mathfrak{so}(3)$, 972
 - $\mathfrak{so}(3, 1)$, 974
 - structure group, 1092, 1101, 1117, 1143, 1144
 - subgroup, 743
 - subgroups of $GL(V)$, 967–969
 - Representation of
 - $\mathfrak{su}(n)$, 969
 - Representation
 - symmetric group, 761–776
 - analytic construction, 761–763
 - graphical construction, 764–767
 - products, 774–776
 - Young tableaux, 766
 - tensor product, 128, 751
 - antisymmetrized, 752
 - character, 751
 - symmetrized, 752
 - trivial, 732, 1092
 - twisted adjoint, 987
 - Representation of
 - $\mathfrak{u}(n)$, 968
 - Representation
 - unitary, 730
 - compact Lie group, 954
 - upper-triangular, 175
 - vectors, 137
 - Residue, 339–341
 - definite integrals, 344–358
 - definition, 340
 - integration
 - rational function, 345–348
 - rational trig function, 348–350
 - trig function, 350–352
 - Residue theorem, 340
 - Resolution of identity, 536, 740, 774
 - Resolvent, 534–539
 - compact, 564
 - unbounded operator, 563–569
 - Green's functions, 630
 - Laurent expansion, 535
 - perturbation theory, 655
 - Resolvent set, 517
 - openness of, 521
 - Resonant cavity, 585, 597
 - Riccati equation, 455, 1040
 - Ricci, 1131, 1146
 - Ricci tensor, 1162, 1163, 1165
 - Riemann, 36, 268, 366, 755, 896, 956, 1055, 1130
 - biography, 1144
 - Riemann identity, 472
 - Riemann normal coordinates, 1138–1140
 - Riemann sheet, 365, 367
 - Riemann surface, 366–371
 - Riemann-Christoffel symbols, 1130
 - Riemannian geometry, 1143–1174
 - gravity
 - Newtonian, 1161–1163
 - isometry, 1155–1159
 - Killing vector field, 1155–1159
 - Newtonian gravity, 1161–1163
 - orthogonal bases, 1148–1155
 - Riemannian manifold, 1144
 - Riesz-Fischer theorem, 222
 - Right annihilator, 73
 - Right coset, 708
 - Right ideal, 73
 - Right translation, 921
 - Right-invariant 1-form, 921
 - Right-invariant vector field, 921
 - Right-shift operator, 513
 - eigenvalues of, 518
 - Rigid rotations, 706
 - Rodriguez formula, 243, 245, 446
 - Rosetta stone, 267
 - Rotation algebra, 972
 - Rotation group, 727, 970
 - character, 973
 - Rotation matrix, 972
 - Wigner formula, 972
 - Russell, 11, 897
- S**
- Saddle point approximation, 382
 - Sawtooth voltage, 270
 - Scalar, 20
 - Scalar operator, 757, 758
 - Scalar product, 29
 - Scale transformations, 920
 - Scattering theory, 595
 - Schelling, 791
 - Schmidt, biography, 34
 - Schopenhauer, 791
 - Schrödinger, 115, 907
 - Schrödinger equation, 109, 396, 442, 469, 480, 582, 593, 683, 727
 - classical limit, 452, 453
 - one dimensional, 451
 - Schur, 764, 957, 981
 - biography, 734
 - Schur's lemma, 732, 733, 758, 953, 969
 - Schwarz, 523, 792
 - biography, 36
 - Schwarz inequality, 35, 59, 211, 218, 222, 515, 540, 950, 956

- Schwarz reflection principle, 374–376
- Schwarzschild, biography, 1164
- Schwarzschild geodesic, 1169–1174
- Schwarzschild metric, 1149
- Schwarzschild radius, 1169
- Second order PDE, 640–643
- Second-order PDE
classification, 641
- Section
global, 1083
local, 1083
parallel, 1091, 1119
- Selection rules, 753
- Self-adjoint, 115, 193, 194, 198, 201, 206, 433, 435, 533, 566, 569, 613, 616, 619, 628, 633, 649, 663, 665, 673, 679, 692, 694, 956
formally, 613
- Semi-Riemannian manifold, 1144
- Semi-simple algebra, 88–91, 92, 92, 94, 130, 764, 799, 844
- Semi-simple Lie algebra, 948
- Separable kernel, 556
- Separable potential, 683
- Separated boundary conditions, 566
- Separation of variables, 396
Cartesian, 579–585
conducting box, 579–581
conducting plate, 581, 582
quantum particle in a box, 582–584
wave guides, 584, 585
cylindrical, 586–590
conducting cylindrical can, 586–588
current distribution, 589, 590
cylindrical wave guide, 588, 589
spherical, 590–595
Helmholtz equation, 593
particle in a sphere, 593, 594
plane wave expansion, 594, 595
radial part, 591, 592
- Separation theorem, 430–432
- Sequence, 9
Cauchy, 9
complete orthonormal, 219
- Series
Clebsch-Gordan, 754
complex, 319–321
Fourier, 265–276
Fourier-Bessel, 587
Laurent, 321–330
Neumann, 653, 654
SOLDE solutions, 436–446
Taylor, 321–330
vector, 215–220
- Sesquilinear inner product, 31
- Set, 1–4
Cantor, 12
compact, 519–523
complement of, 2
countably infinite, 11
element of, 1
empty, 2
intersection, 2
matrices, 7
natural numbers, 2
partition of a, 4
uncountable, 12
union, 2
universal, 2
- Sharp map, 801, 902
- Signature of \mathfrak{g} , 813
- Similarity transformation, 148–151
orthonormal basis, 149
- Simple algebra, 76, 88, 90–92, 94, 126, 129, 852, 948, 999
classification, 92–95
- Simple arc, 309
- Simple character, 737
- Simple Lie algebra, 948
- Simple pole, 342
- Simple zero, 330
- Simultaneous diagonalizability, 185
- Simultaneous diagonalization, 185–188
- Singleton, 2
- Singular point, 301, 339, 354, 355
differential equation, 422
irregular, 461
isolated, 463
regular, 461, 470
removable, 342
Sturm-Liouville equation, 572
transformation, 644
- Singularity, 301, 302, 324, 439, 637
confluent HGDE, 479
essential, 342
Green's function, 651
isolated, 339, 342–344
classification, 342
rational function, 343
removable, 343, 355
Schwarzschild solution, 1169
- Skew-symmetry, 53, 793
- Skin depth, 589
- $SL(\mathcal{V})$ as a Lie group, 916
 $SL(\mathcal{V})$
Lie algebra of, 924
normal subgroup of $GL(\mathcal{V})$, 711
- Smooth arc, 309
- SOLDE, 421–425
adjoint, 434
branch point, 464
canonical basis, 463
characteristic exponents, 465
complex, 463–469
confluent hypergeometric, 479
constant coefficients, 446–449
existence theorem, 440
Frobenius method, 439–444
homogeneous, 422

- SOLDE (*cont.*)
- hypergeometric
 - Jacobi functions, 477
 - hypergeometric function, 473
 - indicial equation, 465
 - integral equation of, 545
 - Lagrange identity, 435
 - normal form, 422
 - power-series solutions, 436–446
 - regular singular point, 464
 - singular point, 422
 - Sturm-Liouville systems, 569–573
 - uniqueness theorem, 424
 - variation of constants, 429
 - WKB method, 450–453
 - Wronskian, 425
- SOLDO, 614
- Solid angle
- m -dimensional, 646
- Solid-state physics, 275
- Space
- Banach, 218
 - complex coordinate, 21
 - dual, 48
 - factor, 24, 25, 77
 - inner product, 31
 - metric, 8–10
 - complete, 10
 - projective, 4
 - quotient, 24, 25
 - real coordinate, 21
 - square-integrable functions, 221
 - target, 5
 - vector, 19–29
- Spacelike vector, 941
- Spacetime
- spherically symmetric, 1168
 - static, 1167
 - stationary, 1167
- Spacetime translation, 1070
- Span, 22
- Special linear group, 706
- Special orthogonal group, 706, 925
- Lie algebra of, 925
- Special relativity, 808, 940, 975, 979, 1059
- Special unitary group, 706
- Lie algebra of, 924
- Spectral decomposition
- complex, 177–188
 - orthogonal operator, 201
 - real, 191–205
 - real normal operator, 198–205
 - symmetric operator, 193–198
- Spectral decomposition theorem, 688
- Spectral theorem
- compact hermitian, 530
 - compact normal, 532
 - compact operators, 527–534
- Spectrum
- bounded operator, 522
 - closure of, 521
 - compact operator, 527
 - Hilbert space operator, 517
 - integral operator, 545
 - linear operator, 517, 518
 - permutation operator, 208
- Spherical Bessel functions, 487, 593
- expansion of plane wave, 594
- Spherical coordinates
- multidimensional, 645, 646
- Spherical harmonics, 406–413, 970
- addition theorem, 412, 413, 974
 - definition, 408
 - expansion in terms of, 411, 412
 - expansion of plane wave, 595, 698
 - first few, 410
- Spin representation, 1003
- faithful, 1003
- Spin**(μ, ν), 996
- Spinor, 995–1006
- algebra $\mathbf{C}_\mu^{\nu}(\mathbb{R})$, 1001–1003
- Spinor bundles, 1101
- Spinor space, 1003
- Spinoza, 791
- Split complex numbers, 847
- Square wave voltage, 269
- Square-integrable functions, 221–227
- Stabilizer, 918
- Standard basis, 23
- Standard horizontal vector field, 1121
- Standard model, 1079
- Static spacetime, 1167
- Stationary spacetime, 1167
- Steepest descent method, 382–388
- Step function, 231, 357, 684
- Stereographic projection
- n -sphere, 865
 - two-sphere, 862
- Stirling approximation, 385
- Stokes' Theorem, 899
- Stone-Weierstrass theorem, 222
- generalized, 265
- Stress energy tensor, 1165
- Strictly positive operator, 117
- Strictly upper triangular matrices, 66
- Structure
- complex, 45–48
- Structure constant, 78, 937, 939, 976, 984, 1093, 1095, 1113
- Lie algebra, 927
- Structure equation, 1093
- Structure group
- matrix, 1096, 1097
- Sturm, biography, 568
- Sturm-Liouville
- operator, 566
 - problem, 243, 674
 - system, 411, 567, 569–573, 689

- Sturm-Liouville (*cont.*)
 asymptotic behavior, 573–577
 completeness, 577
 eigenfunctions, 567
 eigenvalues, 568
 expansion in eigenfunctions,
 577–579
 large argument, 577
 large eigenvalues, 573–576
 regular, 567
 singular, 572
- Subalgebra, 64, 73–78
- Subgroup, 705–713
 conjugate, 707
 generated by a subset, 707
 normal, 709
 trivial, 706
- Submanifold, 863
 open, 863
- Subset, 2
 bounded, 520
 closed, 520
 convex, 528
 dense, 520
 open, 520
 proper, 2
- Subspace, 22–24
 invariant, 44, 127, 169–172, 175, 177,
 192, 193, 198, 402, 530, 728,
 731, 733, 734, 738, 740, 749,
 758, 840, 955, 959, 967, 969,
 977, 989
 nongenerate, 810
 stable, 99, 127, 989
- Sum
 direct, 25–28
- Superposition principle
 linear DEs, 422
- Surjective map, 5
- Symmetric algebra, 791
- Symmetric bilinear form, 804
 classification, 807
 definite, 807
 indefinite, 807
 index of, 807
 inner product, 805
 negative definite, 807
 negative semidefinite, 807
 nongenerate, 805
 positive definite, 807
 positive semidefinite, 807
 semidefinite, 807
- Symmetric group, 704, 715–720
 characters
 graphical construction, 767–771
 cycle, 716
 identical particles, 774
 irreducible representation of, 772
 permutation
 parity of, 718
 representation, 761–776
 analytic construction, 761–763
 antisymmetric, 732
 graphical construction, 764–767
 products, 774–776
 Young operators, 771–774
 transposition, 717
- Symmetric homomorphism, 705
- Symmetric operator
 extremum problem, 197
 spectral decomposition, 193–198
- Symmetric product, 791
- Symmetrizer, 790
- Symmetry, 3, 8
 algebraic equations, 1009–1014
 calculus of variations, 1062–1065
 conservation laws, 1065–1069
 classical field theory, 1069–1073
 differential equations, 1014–1024
 first-order ODEs, 1037–1039
 heat equation, 1030–1034
 higher-order ODEs, 1039, 1040
 multiparameter, 1040–1043
 tensors, 789–794
 wave equation, 1034–1036
- Symmetry group
 defining equations, 1030
 of a subset, 1009
 of a system of DEs, 1017
 projectable, 1017
 transform of a function, 1016
 variational, 1062
- Symplectic algebra, 939
- Symplectic charts, 902
- Symplectic form, 801, 902
 rank of, 801
- Symplectic geometry, 51, 901–909, 1079
 conservation of energy, 906
- Symplectic group, 707, 803, 939
- Symplectic manifold, 902
- Symplectic map, 801, 902
- Symplectic matrix, 804
- Symplectic structure, 902
- Symplectic transformation, 801
- Symplectic vector space, 801–804
 canonical basis of, 802
 Hamiltonian dynamics, 803
- T**
- Tangent bundle, 877
- Tangent space, 869
- Tangent vector, 868
 manifold, 866–872
- Tangential coordinates, 637
- Tangents to a curve
 components, 874
- Target space, 5
- Taylor expansion, 104
- Taylor formula, 96

- Taylor series, 321–330
 - construction, 321
 - Tensor, 784
 - classical definition, 787
 - components of, 785
 - contravariant, 784
 - contravariant-antisymmetric, 793
 - contravariant-symmetric, 789
 - covariant, 784
 - covariant-antisymmetric, 793
 - covariant-symmetric, 789
 - dual space, 782
 - Levi-Civita, 799
 - multilinear map, 782–789
 - symmetric, 789
 - symmetric product, 791
 - symmetries, 789–794
 - transformation law, 786
 - types of, 784
 - Tensor algebra, 784
 - Tensor bundle, 883
 - Tensor field, 883, 887
 - crucial property of, 883
 - curvature, 1125–1132
 - manifold, 876–888
 - torsion, 1125–1132
 - Tensor operator
 - irreducible, 756–758
 - Tensor product, 28, 29, 783, 784
 - algebra, 68
 - group representation
 - Clebsch-Gordan decomposition, 753–756
 - of vector spaces, 751
 - Tensorial form, 1092
 - Test function, 233
 - Theta function, 357
 - Timelike vector, 941
 - Topology, 8
 - Torsion, 1125–1132
 - Torsion form, 1122
 - Torsion tensor field, 1125
 - Total derivative, 1027
 - Total divergence, 1060
 - Total matrix algebra, 78–80, 92, 846, 850, 852, 997, 999
 - Total space, 1080
 - Trace, 160–162
 - and determinant, 161
 - definition, 160
 - log of determinant, 162
 - relation to determinant, 160
 - Transformation
 - similarity, 148–151
 - Transformation group, 704
 - Transition function, 1081
 - Transitivity, 3
 - Translation, 919
 - Translation operator, 209
 - Transpose of a matrix, 142
 - Traveling waves, 584
 - Triangle inequality, 8, 36, 38, 133, 216, 301
 - Trigonometric function
 - integration of, 350–352
 - Trivial bundle, 1080
 - Trivial homomorphism, 705
 - Trivial representation, 732
 - Trivial subgroup, 706
 - Twin paradox
 - as a variational problem, 1060
 - Twisted adjoint representation, 987
- U**
- Unbounded operator, 563–569
 - Uncertainty principle, 133
 - Uncertainty relation, 279
 - Uncountable set, 12
 - Union, 2
 - Unit circle, 7
 - Unital algebra, 63, 72
 - Unital homomorphism, 72
 - Unitary, 40
 - Unitary group, 706
 - Lie algebra of, 924
 - Unitary operator, 114–119
 - Unitary representation, 730
 - Universal set, 2
 - Upper-triangular matrix, 66, 83, 175, 176
- V**
- Vandermonde, biography, 153
 - Variational derivative, 1051
 - Variational problem, 1053–1060
 - twin paradox, 1060
 - Variational symmetry group, 1062
 - Vector, 19
 - Cartesian, 19
 - component, 23
 - dual of, 51
 - infinite sum, 215–220
 - isotropic, 808
 - length, 36–38
 - norm of, 36
 - normal, 32
 - null, 808
 - orthogonal, 32
 - tangent
 - manifold, 866–872
 - Vector bundle, 1117
 - Vector field, 877
 - as streamlines, 879
 - complete, 881
 - curl of, 889
 - flow of a, 881
 - fundamental, 1086
 - gauge transformation of, 1104
 - Hamiltonian, 905
 - horizontal, 1087

- Vector field (*cont.*)
 integral curve of, 879
 Killing, 1155–1159
 left-invariant, 920
 Lie algebra of, 879
 manifold, 877–882
 standard horizontal, 1121
 vertical, 1087
- Vector potential, 3, 1099
- Vector space, 8, 19–29
 automorphism, 43
 basis
 components in a, 23
 basis of a, 23
 complete, 216
 complex, 20
 definition, 19
 dual, 48
 endomorphism of a, 39
 finite-dimension
 criterion for, 522
 finite-dimensional, 23
 indefinite inner product
 orthonormal basis, 812–819
 subspaces, 809–812
 isomorphism, 43
 linear operator on a, 39
 Minkowski, 815
 normed, 36
 compact subset of, 522
 operator on a, 39
 orientation, 800, 801
 oriented, 800
 real, 20
 self-dual, 805
 semi-Euclidean, 815
 symplectic, 801–804
- Vertical vector field, 1087
- Volterra, biography, 545
- Volterra equation, 543
- Volume element, 801
 relative to an inner product, 816
- Von Humboldt, 246, 666, 792
- Von Neumann, 981
 biography, 532
- W**
- Wave equation, 395, 584
 hyperbolic, 642
 symmetry group, 1034–1036
- Wave guide, 584
 cylindrical, 588, 589
 rectangular, 584, 585, 600
- Weber-Hermite equation, 487
- Wedderburn decomposition, 92
- Wedge product, 794
- Weierstrass, 10, 36, 366, 640, 792, 946
 biography, 523
- Weight function, 32
- Weyl, 799, 946, 1015, 1070
 biography, 956
- Weyl basis, 938, 947
- Weyl operator, 955
- Wigner, 236, 1015
 biography, 981
- Wigner formula, 972
- Wigner-Eckart theorem, 758
- Wigner-Seitz cell, 276
- WKB method, 450–453
 connection formulas, 451
- Wordsworth, 907
- Wronski, biography, 425
- Wronskian, 425–432, 567
- Y**
- Young, 957
- Young antisymmetrizer, 772
- Young frame, 765, 772
 negative application, 768
 positive application, 768
 regular application, 767
- Young operator, 771–774, 963
- Young pattern, 765
- Young symmetrizer, 772
- Young tableaux, 766, 964
 horizontal permutation, 772
 regular graphs, 766
 vertical permutation, 772
- Yukawa potential, 282
- Z**
- Zero of order k , 329